

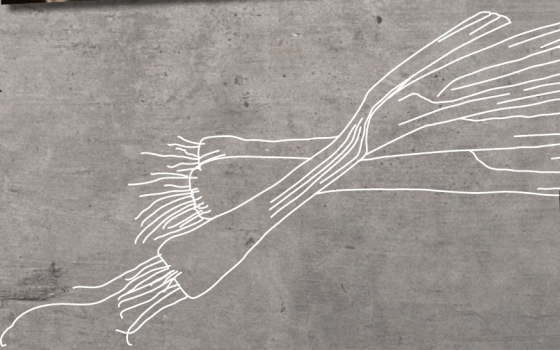

FREEZER

en Instruction for Use

G..14..
G..24..



en Table of Contents

Safety and warning information	3	Freezing and storing food	11
Information concerning disposal	6	Freezing fresh food	11
Scope of delivery	6	Super freezing	12
Room temperature, ventilation and cavity depth	7	Thawing frozen food	13
Installation location	7	Interior fittings	13
Connecting the appliance	8	Switching off and disconnecting the appliance	14
Getting to know your appliance	8	Defrosting	14
Switching the appliance on	9	Cleaning the appliance	15
Setting the temperature	9	Tips for saving energy	15
Alarm function	10	Operating noises	16
Usable capacity	10	Eliminating minor faults yourself	16
Freezer compartment	10	Customer service	17
Max. freezing capacity	11		

Safety and warning information

Before you switch ON the appliance

Please read the operating and installation instructions carefully! They contain important information on how to install, use and maintain the appliance. The manufacturer is not liable if you fail to comply with the instructions and warnings. Retain all documents for subsequent use or for the next owner.

Technical safety

The appliance contains a small quantity of environmentally friendly but flammable refrigerant R600a. Ensure that the tubing of the refrigerant circuit is not damaged during transportation and installation. Leaking refrigerant may cause eye injuries or ignite.

If damage has occurred

- Keep naked flames and/or ignition sources away from the appliance,
- thoroughly ventilate the room for several minutes,

- switch off the appliance and pull out the mains plug,
- inform customer service.

The more refrigerant an appliance contains, the larger the room must be in which the appliance is situated. Leaking refrigerant can form a flammable gas-air mixture in rooms which are too small. The room must be at least 1 m³ per 8 g of refrigerant. The amount of refrigerant in your appliance is indicated on the rating plate inside the appliance.

If the power cord of this appliance is damaged, it must be replaced by the manufacturer, customer service or a similarly qualified person. Improper installations and repairs may put the user at considerable risk.

Repairs may be performed by the manufacturer, customer service or a similarly qualified person only.

Only original parts supplied by the manufacturer may be used. The manufacturer guarantees that only these parts satisfy the safety requirements.

An extension cable may be purchased from customer service only.

Important information when using the appliance

- Never use electrical appliances inside the appliance (e.g. heater, electric ice maker, etc.). Explosion hazard!
- Never defrost or clean the appliance with a steam cleaner! The steam may penetrate electrical parts and cause a short-circuit. Risk of electric shock!
- Do not use pointed or sharp-edged implements to remove frost or layers of ice. You could damage the refrigerant tubes. Leaking refrigerant may cause eye injuries or ignite.
- Do not store products which contain flammable propellants (e.g. spray cans) or explosive substances in the appliance. Explosion hazard!
- Do not stand on or lean heavily against base of appliance, drawers or doors, etc
- For defrosting and cleaning, pull the mains plug out or switch off the fuse. Do not pull out the mains plug by tugging on the power cord.
- Store high-percentage alcohol tightly closed and standing up.

- Keep plastic parts and the door seal free of oil and grease. Otherwise, parts and door seal will become porous.
- Never cover or block the ventilation openings of the appliance!

■ **Avoiding placing children and vulnerable people at risk:**

At risk are children, people who have limited physical, mental or sensory abilities, as well as people who have inadequate knowledge concerning safe operation of the appliance.

Ensure that children and vulnerable people have understood the hazards.

A person responsible for safety must supervise or instruct children and vulnerable people who are using the appliance.

Only children from 8 years and above may use the appliance.

Supervise children who are cleaning and maintaining the appliance.

Never allow children to play with the appliance.

- Do not store bottled or canned drinks (especially carbonated drinks) in the freezer compartment. Bottles and cans may burst!
- Never put frozen food straight from the freezer compartment into your mouth.
Risk of low-temperature burns!
- Avoid prolonged touching of frozen food, ice or the evaporator pipes, etc.
Risk of low-temperature burns!

Children in the household

- Keep children away from packaging and its parts.
Danger of suffocation from folding cartons and plastic film!
- Do not allow children to play with the appliance!
- If the appliance features a lock:
keep the key out of the reach of children!

General regulations

The appliance is suitable

- for freezing food,
- for making ice.

This appliance is intended for use in the home and the home environment.

The appliance is suppressed according to EU Directive 2004/108/EC.

The refrigeration circuit has been checked for leaks.

This product complies with the relevant safety regulations for electrical appliances (EN 60335-2-24).

This appliance is intended for use up to a maximum height of 2000 metres above sea level.

Information concerning disposal

Disposal of packaging

The packaging protects your appliance from damage during transit. All utilised materials are environmentally safe and recyclable. Please help us by disposing of the packaging in an environmentally friendly manner.

Please ask your dealer or inquire at your local authority about current means of disposal.

Disposal of your old appliance

Old appliances are not worthless rubbish! Valuable raw materials can be reclaimed by recycling old appliances.



This appliance is labelled in accordance with European Directive 2012/19/EU concerning used electrical and electronic appliances (waste electrical and electronic equipment - WEEE). The guideline determines the framework for the return and recycling of used appliances as applicable throughout the EU.

Warning

Redundant appliances

1. Pull out the mains plug.
2. Cut off the power cord and discard with the mains plug.
3. Do not take out the trays and receptacles: children are therefore prevented from climbing in!
4. Do not allow children to play with the appliance once it has spent its useful life. Danger of suffocation!

Refrigerators contain refrigerant and gases in the insulation. Refrigerant and gases must be disposed of professionally. Ensure that tubing of the refrigerant circuit is not damaged prior to proper disposal.

Scope of delivery

After unpacking all parts, check for any damage in transit.

If you have any complaints, please contact the dealer from whom you purchased the appliance or our customer service.

The delivery consists of the following parts:

- Built-in appliance
- Interior fittings (depending on model)
- Bag containing installation materials
- Operating instructions
- Installation manual
- Customer service booklet
- Warranty enclosure
- Information on the energy consumption and noises

Room temperature, ventilation and cavity depth

Ambient temperature

The appliance is designed for a specific climate class. Depending on the climate class, the appliance can be operated at the following temperatures.

The climate class can be found on the rating plate. Fig. **8**

Climate class	Permitted ambient temperature
SN	+10 °C to 32 °C
N	+16 °C to 32 °C
ST	+16 °C to 38 °C
T	+16 °C to 43 °C

Note

The appliance is fully functional within the room temperature limits of the indicated climatic class. If an appliance of climatic class SN is operated at colder room temperatures, the appliance will not be damaged up to a temperature of +5 °C.

Ventilation

The air on the rear panel of the appliance heats up. Conduction of the heated air must not be obstructed. Otherwise, the refrigeration unit must work harder. This increases power consumption. Therefore: Never cover or block the ventilation openings!

Cavity depth

A cavity depth of 560 mm is recommended for the appliance. If the cavity depth is smaller – at least 550 mm – the energy consumption increases slightly.

Installation location

Install the appliance in a dry, well ventilated room. The installation location should neither be exposed to direct sunlight nor near a heat source, e. g. a cooker, radiator, etc. If installation next to a heat source is unavoidable, use a suitable insulating plate or observe the following minimum distances to a heat source:

- 3 cm to electric or gas cookers.
- 30 cm to an oil or coal-fired cooker.

Connecting the appliance

After installing the appliance, wait at least 1 hour until the appliance is switched on. During transportation the oil in the compressor may have flowed into the refrigeration system.

Before switching on the appliance for the first time, clean the interior of the appliance (see chapter "Cleaning the appliance").

Electrical connection

The socket must be near the appliance and also freely accessible following installation of the appliance.

The appliance complies with the protection class I. Connect the appliance to 220–240 V/50 Hz alternating current via a correctly installed socket with protective conductor. The socket must be fused with a 10 to 16 A fuse.

For appliances operated in non-European countries, check whether the stated voltage and current type match the values of your mains supply. This information can be found on the rating plate. Fig. **8**

Getting to know your appliance

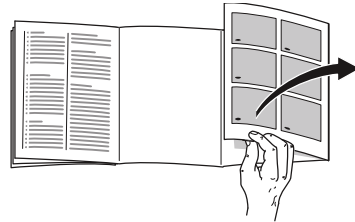

Please fold out the illustrated last page. These operating instructions refer to several models.

The features of the models may vary.

The diagrams may differ.

Fig. **1**

- 1-5 Controls
- 6 Freezer shelf
- 7 Frozen food container

Controls

Fig. 2

- 1 **Temperature controller**
Is used to set the freezer compartment temperature.
- 2 **On/Off button**
Serves to switch the whole appliance on and off.
- 3 **“super” button**
Switches super freezing on and off.
Illuminates when super freezing is on.
- 4 **Alarm button**
Used to switch off the warning signal, see chapter “Alarm function”.
- 5 **Alarm display**
Lights up if the freezer compartment becomes too warm. It goes out when the freezer compartment has reached the set temperature.

Switching the appliance on

Fig. 2

Press the On/Off button 2, the button is lit. The temperature alarm is switched off by pressing the alarm button 4. The alarm display 5 lights up until the appliance has reached the set temperatures.

We recommend the medium setting.

Operating tips

- The sides of the housing are sometimes heated slightly. This prevents condensation in the area of the door seal.
- If the freezer compartment door cannot be immediately re-opened after it has been closed, wait until the resulting low pressure has equalised.
- The refrigeration system may cause several areas of the freezer shelves to frost quickly. This does not affect function or power consumption. The appliance does not require defrosting until the entire surface of the freezer shelf is covered with more than 5 mm of frost or ice.

Setting the temperature

Fig. 2

Set the temperature controller 1 to a number with a coin. The higher the number, the lower the temperature.

Alarm function

Temperature alarm

The temperature alarm switches on if the freezer compartment is too warm and the frozen food is at risk of thawing.

The alarm may switch on without any risk to the frozen food:

- when the appliance is switched on,
- when large quantities of fresh food are placed in the appliance,
- if the freezer compartment door is open too long.

Note

Do not refreeze thawing or thawed food. Only ready meals (boiled or fried) may be refrozen.

No longer store the frozen produce for the max. storage period.

Alarm display

Fig. 2

The alarm display 5 lights up if the freezer compartment becomes too warm. Frozen food is at risk of thawing.

Switching off the alarm

Fig. 2

Press the alarm button 4 to switch off the warning signal.

Usable capacity

Information on the usable capacity can be found inside your appliance on the rating plate. Fig. 8

Fully utilising the freezer volume

The maximum amount of food can be placed in the freezer by removing all fittings. The food can be stacked directly on the shelves and in the bottom of the freezer compartment.

Removing the fittings

Pull out the frozen food container all the way, lift at the front and remove. Fig. 3

Freezer compartment

Use the freezer compartment

- To store deep-frozen food.
- To make ice cubes.
- To freeze food.

Note

Ensure that the freezer compartment door has been closed properly. If the door is open, the frozen food will thaw. The freezer compartment will become covered in thick ice. Also: waste of energy due to high power consumption!

Max. freezing capacity

Information about the max. freezing capacity within 24 hours can be found on the rating plate. Fig. **8**

Freezing and storing food

Purchasing frozen food

- Packaging must not be damaged.
- Use by the “use by” date.
- Temperature in the supermarket freezer must be -18 °C or lower.
- If possible, transport deep-frozen food in an insulated bag and place quickly in the freezer compartment.

Note when loading products

- Preferably freeze large quantities of food in the top compartment, where food freezes particularly quickly and therefore also gently.
- Place the food over the whole area of the compartments or the frozen food containers.

Note

Food which is already frozen must not come into contact with the food which is to be frozen. If required, move the frozen food to other frozen food containers.

Storing frozen food

Insert frozen food container all the way to ensure unrestricted air circulation.

Freezing fresh food

Freeze fresh and undamaged food only.

To retain the best possible nutritional value, flavour and colour, vegetables should be blanched before freezing. Aubergines, peppers, zucchini and asparagus do not require blanching. Literature on freezing and blanching can be found in bookshops.

Note

Keep food which is to be frozen away from food which is already frozen.

- The following foods are suitable for freezing:
 - Cakes and pastries, fish and seafood, meat, game, poultry, vegetables, fruit, herbs, eggs without shells, dairy products such as cheese, butter and quark, ready meals and leftovers such as soups, stews, cooked meat and fish, potato dishes, soufflés and desserts.
- The following foods are not suitable for freezing:
 - Types of vegetables, which are usually consumed raw, such as lettuce or radishes, eggs in shells, grapes, whole apples, pears and peaches, hard-boiled eggs, yoghurt, soured milk, sour cream, crème fraîche and mayonnaise.

Packing frozen food

To prevent food from losing its flavour or drying out, place in airtight containers.

1. Place food in packaging.
2. Remove air.
3. Seal the wrapping.
4. Label packaging with contents and date of freezing.

Suitable packaging:

Plastic film, tubular film made of polyethylene, aluminium foil, freezer containers.

These products are available from specialist outlets.

Unsuitable packaging:

Wrapping paper, greaseproof paper, cellophane, bin liners and used shopping bags.

Items suitable for sealing packaged food:

Rubber bands, plastic clips, string, cold-resistant adhesive tape, etc.

Bags and tubular film made of polyethylene can be sealed with a film heat sealer.

Shelf life of frozen food

Storage duration depends on the type of food.

At a temperature of -18 °C:

- Fish, sausage, ready meals and cakes and pastries:
up to 6 months
- Cheese, poultry and meat:
up to 8 months
- Vegetables and fruit:
up to 12 months

Super freezing

Food should be frozen solid as quickly as possible in order to retain vitamins, nutritional value, appearance and flavour.

Several hours before placing fresh food in the freezer compartment, switch on super freezing to prevent an unwanted temperature rise.

As a rule, 4–6 hours is adequate.

This appliance runs constantly and the freezer compartment drops to a very low temperature.

If the max. freezing capacity is to be used, super freezing must be switched on for 24 hours before the fresh produce is placed in the freezer compartment.

Smaller quantities of food (up to 2 kg) can be frozen without “super freezing”.

Switching on and off

Fig. 2

Press “super” button 3.

If the super freezing has been switched on the button is lit.

Super freezing automatically switches off after approx. 2½ days.

Thawing frozen food

Depending on the type and application, select one of the following options:

- at room temperature
- in the refrigerator
- in an electric oven, with/without fan assisted hot-air
- in the microwave

Caution

Do not refreeze thawing or thawed food. Only ready meals (boiled or fried) may be refrozen.

No longer store the frozen produce for the max. storage period.

Interior fittings

(not all models)

Freezer calendar

Fig. **4**

To prevent the quality of the frozen food from deteriorating, do not exceed the storage duration. The figures next to the symbols indicate the permitted storage period of the produce in months. In the case of commercially available frozen food observe the date of manufacture or use-by date.

Ice cube tray

Fig. **5**

1. Fill the ice cube tray $\frac{3}{4}$ full of drinking water and place in the freezer compartment.
2. If the ice tray is stuck to the freezer compartment, loosen with a blunt implement only (spoon-handle).
3. To loosen the ice cubes, twist the ice tray slightly or hold briefly under flowing water.

Ice pack

Fig. **6/A**

If a power failure or malfunction occurs, the ice packs can be used to slow down the thawing process. The longest storage time is obtained by placing the ice pack on the food in the top compartment.

The ice packs can also be used to cool food temporarily, e.g. in a cold bag.

Berry tray

Fig. **6/B**

The berry tray is suitable for storing ice packs and for freezing individual berries, pieces of fruit, herbs and vegetables. To do this, take out the ice packs, distribute items evenly over the berry tray and leave to freeze for approx. 10 to 12 hours. Then transfer into freezer bags or containers. To thaw the frozen items, spread them out next to each other again.

Switching off and disconnecting the appliance

Switching the appliance off

Fig. 2

Press the On/Off button 2.
Refrigeration unit switches off.

Disconnecting the appliance

If you do not use the appliance for a prolonged period:

1. Switch off the appliance.
2. Pull out mains plug or switch off fuse.
3. Clean the appliance.
4. Leave the appliance door open.

Defrosting

Note

Approx. 4 hours before defrosting the appliance, switch on super freezing so that the food drops to a very low temperature and can therefore be stored at room temperature for a longer period.

Proceed as follows:

1. Place the frozen food containers with the food in a cool location. Place the ice pack (if enclosed) on the food.
2. Switch the appliance off.
3. Pull out the mains plug or remove the fuse.
4. To accelerate the defrosting process, place two pans of hot water on a trivet in the appliance. Close the appliance door to prevent heat from escaping.
Fig. 7
5. Wipe up condensation with a cloth or sponge.
6. Wipe dry the freezer compartment.
7. Switch the appliance on again.
8. Put the frozen food back in the freezer compartment.

Cleaning the appliance

Caution

- Do not use abrasive, chloride or acidic cleaning agents or solvents.
- Do not use scouring or abrasive sponges. The metallic surfaces could corrode.
- Never clean the shelves or containers in the dishwasher. The parts may become deformed!

Proceed as follows:

1. Before cleaning: Switch off the appliance.
2. Pull out the mains plug or switch off the fuse!
3. Take out the food and store in a cool location. Place ice pack (if available) on the food.
4. Wait until the layer of frost has thawed.
5. Clean the appliance with a soft cloth, lukewarm water and a little pH neutral washing-up liquid. The rinsing water must not run into the light or through the drainage hole into the evaporation area.
6. Wipe the door seal with clear water only and then wipe dry thoroughly.
7. After cleaning reconnect and switch the appliance back on.
8. Put the food back into the appliance.

Tips for saving energy

- Install the appliance in a dry, well ventilated room! The appliance should not be installed in direct sunlight or near a heat source (e.g. radiator, cooker).
If required, use an insulating plate.
- Select 560 mm cavity depth.
A smaller cavity depth will result in a higher energy consumption.
- Do not block the ventilation openings in the appliance.
- The ice packs slow down the thawing process of the frozen food in the event of a power failure or malfunction. Place the ice packs directly on the food in the top compartment.
- Open the appliance as briefly as possible!
The briefer the appliance door is opened, the lower the ice formation on the freezer shelves.
- Thaw frozen food in the refrigerator compartment and use the low temperature of the frozen food to cool refrigerated food.
- Regularly defrost the freezer compartment to remove the layer of frost.
A layer of hoarfrost will impair refrigeration of the frozen food and increase power consumption.
- To avoid increased power consumption, occasionally clean the back of the appliance.
- The arrangement of the fittings does not affect the energy rating of the appliance.

Operating noises

Quite normal noises

Droning

Motors are running (e.g. refrigerating units, fan).

Bubbling, humming or gurgling noises

Refrigerant is flowing through the tubing.

Clicking

Motor, switches or solenoid valves are switching on/off.

Preventing noises

The appliance is not level

Please align the installation cavity with a spirit level. To do this, use the height-adjustable feet of the cavity or place something underneath.

Containers or storage areas wobble or stick

Please check the removable parts and re-insert them correctly if required.

Receptacles are touching each other

Move the receptacles slightly away from each other.

Eliminating minor faults yourself

Before you call customer service:

Please check whether you can eliminate the fault yourself based on the following information.

Customer service will charge you for advice – even if the appliance is still under guarantee!

Fault	Possible cause	Remedial action
Displays do not illuminate.	Power failure; the fuse has been switched off; the mains plug has not been inserted properly.	Connect mains plug. Check whether the power is on, check the fuses.
The temperature in the freezer compartment is too warm.	Appliance opened frequently.	Do not open the appliance unnecessarily.
	The ventilation openings have been covered.	Remove obstacles.
	Large quantities of fresh food are being frozen.	Do not exceed max. freezing capacity.

Fault	Possible cause	Remedial action
Warning signal sounds, "Alarm" display lights up. Fig. 2 /5 The freezer compartment is too warm! Frozen food is at risk!		To switch off the warning signal and the flashing display, press the Alarm button 4.
	Appliance is open.	Close the appliance.
	Ventilation openings have been covered.	Ensure that there is adequate ventilation.
	Too much food was placed in the freezer compartment at once.	Do not exceed max. freezing capacity.

Customer service

Your local customer service can be found in the telephone directory or in the customer-service index. Please provide customer service with the appliance product number (E-Nr.) and production number (FD).

These specifications can be found on the rating plate. Fig. **8**

To prevent unnecessary call-outs, please assist customer service by quoting the product and production numbers. This will save you additional costs.

Repair order and advice on faults

Contact information for all countries can be found on the enclosed customer service list.

GB	0344 892 8989	Calls charged at local or mobile rate.
IE	01450 2655	0.03 € per minute at peak. Off peak 0.0088 € per minute.

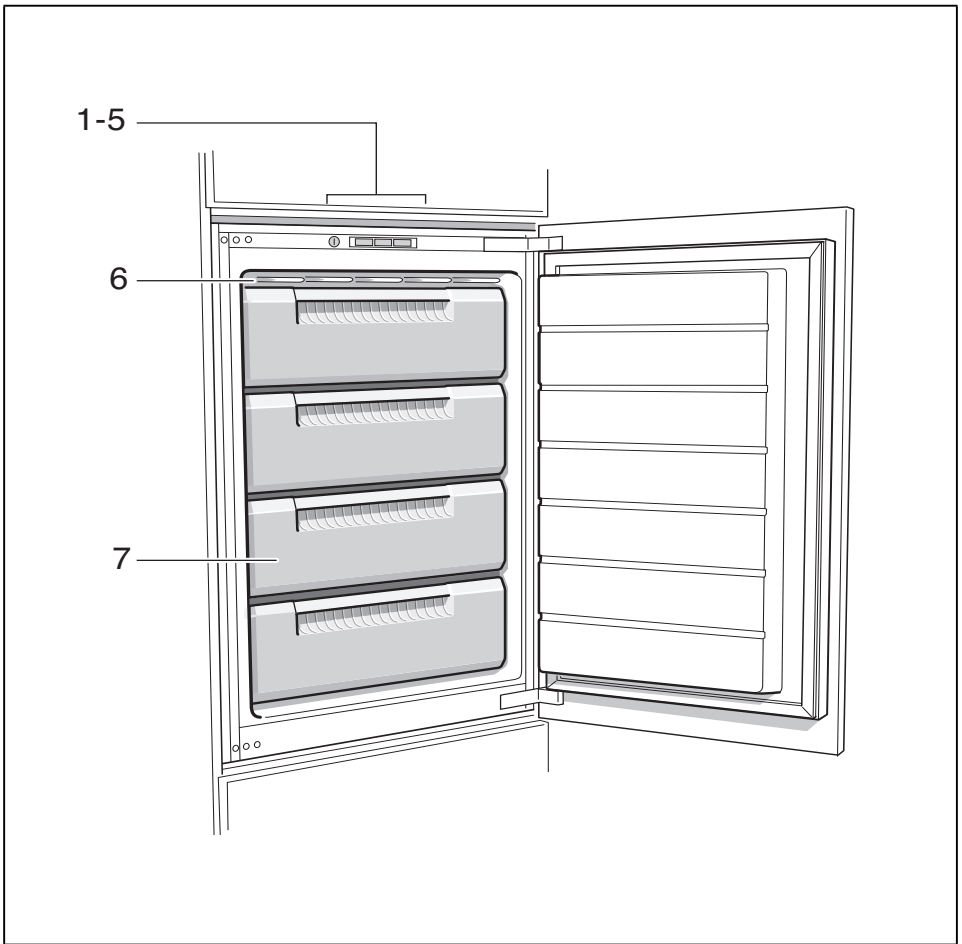

1

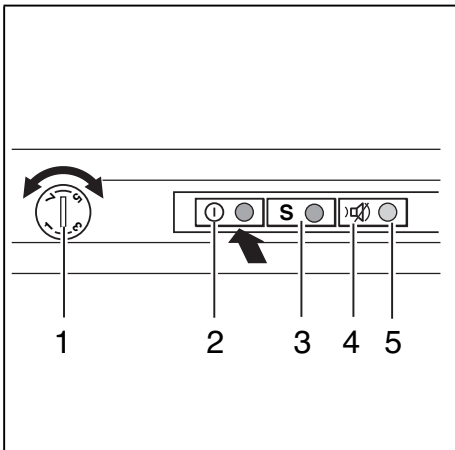

2



3

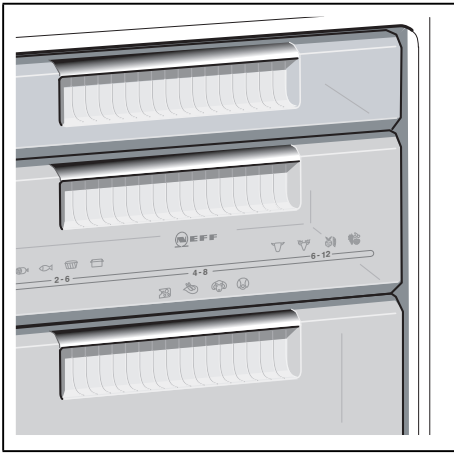

4

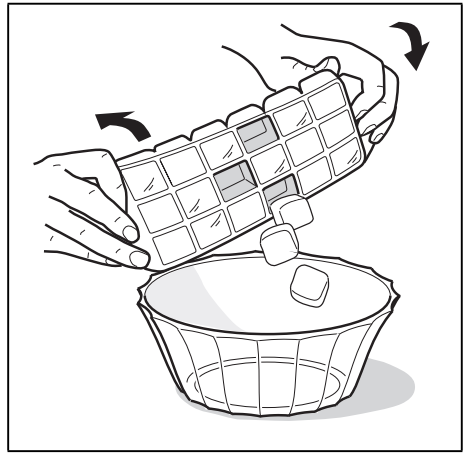

5

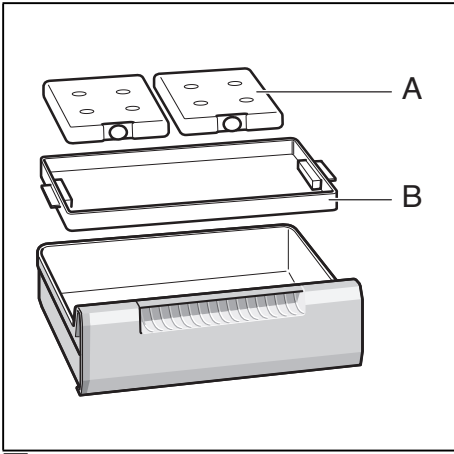

6

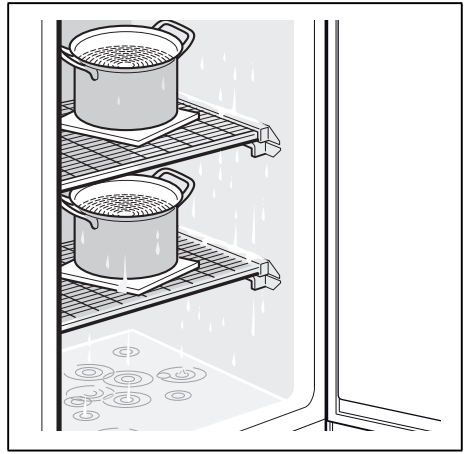

7

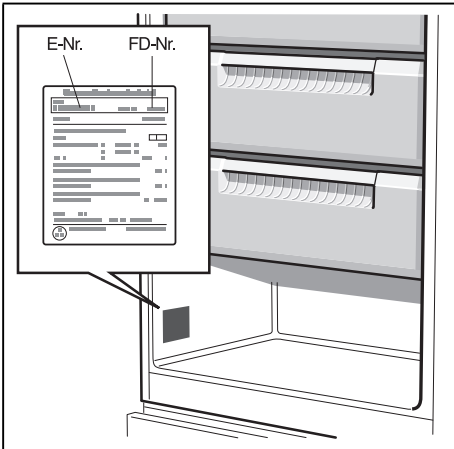

8



REGISTER YOUR PRODUCT
ONLINE [NEFF-HOME.COM](https://www.neff-home.com)

Constructa NEFF Vertriebs-GmbH |
Carl-Wery-Straße 34 | 81739 Munich
Germany



9000874710
(9901)
en