





















Built-in oven

[en] INSTRUCTION MANUAL

B17CR32.1B



Table of contents

| | | | | | |
|--|--|-----------|---|---|-----------|
|  | Intended use | 4 |  | Sabbath mode | 17 |
|  | Important safety information | 4 | | Starting Sabbath mode | 17 |
| | General information | 4 | | Cancelling Sabbath mode | 17 |
| | Halogen lamp | 5 |  | Cleaning agent | 17 |
| | Cleaning function | 5 | | Suitable cleaning agents | 17 |
|  | Causes of damage | 6 | | Surfaces in the cooking compartment | 18 |
| | General information | 6 | | Keeping the appliance clean | 18 |
|  | Environmental protection | 6 |  | Cleaning function | 19 |
| | Saving energy | 6 | | EcoClean | 19 |
| | Environmentally-friendly disposal | 6 | | Floor cleaning aid | 19 |
|  | Getting to know your appliance | 7 |  | Rails | 20 |
| | Control panel | 7 | | Detaching and refitting the rails | 20 |
| | Controls | 7 |  | Appliance door | 21 |
| | Main menu | 8 | | Removing and fitting the appliance door | 21 |
| | Menu for the types of heating | 8 | | Removing the door cover | 21 |
| | Cooking compartment functions | 9 | | Removing and installing the door panels | 22 |
|  | Accessories | 9 |  | Trouble shooting | 23 |
| | Accessories included | 9 | | Fault table | 23 |
| | Inserting accessories | 9 | | Maximum operating time exceeded | 23 |
| | Combining accessories | 10 | | Replacing the bulb in the top of the cooking compartment | 24 |
| | Optional accessories | 10 | | Glass cover | 24 |
|  | Before using for the first time | 11 |  | Customer service | 24 |
| | Initial use | 11 | | E number and FD number | 24 |
| | Cleaning the cooking compartment | 11 |  | Tested for you in our cooking studio | 25 |
| | Cleaning the accessories | 11 | | Silicone moulds | 25 |
|  | Operating the appliance | 12 | | Baking | 25 |
| | Switching the appliance on and off | 12 | | Roasting and braising | 28 |
| | Setting and starting the appliance operation | 12 | | Grilling | 30 |
| | Changing or cancelling the appliance operation | 13 | | Convenience products | 33 |
| | Heating up the appliance quickly | 13 | | Yogurt | 34 |
|  | Time-setting options | 14 | | Save energy with Eco heating types | 34 |
| | Showing and hiding the time-setting options | 14 | | Acrylamide in foodstuffs | 35 |
| | Setting the timer | 14 | | Slow cook | 36 |
| | Setting the cooking time | 14 | | Drying | 37 |
| | Start delay – "Ready at" | 14 | | Preserving | 37 |
| | Checking, changing or deleting settings | 14 | | Allowing the dough to prove at dough proving setting . . 38 | |
|  | Childproof lock | 15 | | Defrosting | 39 |
| | Automatic childproof lock | 15 | | Keeping warm | 40 |
| | One-time childproof lock | 15 | | Test dishes | 40 |
|  | Basic settings | 16 | | | |
| | Changing the basic settings | 16 | | | |
| | List of basic settings | 16 | | | |
| | Setting favourites | 16 | | | |

Additional information on products, accessories, replacement parts and services can be found at www.neff-international.com and in the online shop www.neff-eshop.com

Intended use

Read these instructions carefully. Only then will you be able to operate your appliance safely and correctly. Retain the instruction manual and installation instructions for future use or for subsequent owners.

This appliance is only intended to be fully fitted in a kitchen. Observe the special installation instructions.

Check the appliance for damage after unpacking it. Do not connect the appliance if it has been damaged in transport.

Only a licensed professional may connect appliances without plugs. Damage caused by incorrect connection is not covered under warranty.

This appliance is intended for domestic use only. The appliance must only be used for the preparation of food and drink. The appliance must be supervised during operation. Only use this appliance indoors.

This appliance is intended for use up to a maximum height of 2000 metres above sea level.

This appliance may be used by children over the age of 8 years old and by persons with reduced physical, sensory or mental capabilities or by persons with a lack of experience or knowledge if they are supervised or are instructed by a person responsible for their safety how to use the appliance safely and have understood the associated hazards.

Children must not play with, on, or around the appliance. Children must not clean the appliance or carry out general maintenance unless they are at least 8 years old and are being supervised.

Keep children below the age of 8 years old at a safe distance from the appliance and power cable.

Always slide accessories into the cooking compartment the right way round.

→ "Accessories" on page 9

Important safety information

General information

Warning Risk of fire!

- Combustible items stored in the cooking compartment may catch fire. Never store combustible items in the cooking compartment. Never open the appliance door if there is smoke inside. Switch off the appliance and unplug it from the mains or switch off the circuit breaker in the fuse box.
- A draught is created when the appliance door is opened. Greaseproof paper may come into contact with the heating element and catch fire. Do not place greaseproof paper loosely over accessories during preheating. Always weight down the greaseproof paper with a dish or a baking tin. Only cover the surface required with greaseproof paper. Greaseproof paper must not protrude over the accessories.

Warning Risk of burns!

- The appliance becomes very hot. Never touch the interior surfaces of the cooking compartment or the heating elements. Always allow the appliance to cool down. Keep children at a safe distance.
- Accessories and ovenware become very hot. Always use oven gloves to remove accessories or ovenware from the cooking compartment.
- Alcoholic vapours may catch fire in the hot cooking compartment. Never prepare food containing large quantities of drinks with a high alcohol content. Only use small quantities of drinks with a high alcohol content. Open the appliance door with care.

Warning Risk of scalding!

- The accessible parts become hot during operation. Never touch the hot parts. Keep children at a safe distance.
- When you open the appliance door, hot steam can escape. Steam may not be visible, depending on its temperature. When opening, do not stand too close to the appliance. Open the appliance door carefully. Keep children away.
- Water in a hot cooking compartment may create hot steam. Never pour water into the hot cooking compartment.

⚠ Warning**Risk of injury!**

- Scratched glass in the appliance door may develop into a crack. Do not use a glass scraper, sharp or abrasive cleaning aids or detergents.
- The hinges on the appliance door move when opening and closing the door, and you may be trapped. Keep your hands away from the hinges.

⚠ Warning**Risk of electric shock!**

- Incorrect repairs are dangerous. Repairs may only be carried out and damaged power cables replaced by one of our trained after-sales technicians. If the appliance is defective, unplug the appliance from the mains or switch off the circuit breaker in the fuse box. Contact the after-sales service.
- The cable insulation on electrical appliances may melt when touching hot parts of the appliance. Never bring electrical appliance cables into contact with hot parts of the appliance.
- Do not use any high-pressure cleaners or steam cleaners, which can result in an electric shock.
- A defective appliance may cause electric shock. Never switch on a defective appliance. Unplug the appliance from the mains or switch off the circuit breaker in the fuse box. Contact the after-sales service.

⚠ Warning**Hazard due to magnetism!**

Permanent magnets are used in the control panel or in the control elements. They may affect electronic implants, e.g. heart pacemakers or insulin pumps. Wearers of electronic implants must stay at least 10 cm away from the control panel.

Halogen lamp**⚠ Warning****Risk of electric shock!**

When replacing the cooking compartment bulb, the bulb socket contacts are live. Before replacing the bulb, unplug the appliance from the mains or switch off the circuit breaker in the fuse box.

Cleaning function**⚠ Warning****Risk of burns!**

⚠ The appliance will become very hot on the outside during the cleaning function. Never touch the appliance door. Allow the appliance to cool down. Keep children away from the appliance.

Causes of damage

General information

Caution!

- Accessories, foil, greaseproof paper or ovenware on the cooking compartment floor: do not place accessories on the cooking compartment floor. Do not cover the cooking compartment floor with any sort of foil or greaseproof paper. Do not place ovenware on the cooking compartment floor if a temperature of over 50 °C has been set. This will cause heat to accumulate. The baking and roasting times will no longer be correct and the enamel will be damaged.
- Aluminium foil: Aluminium foil in the cooking compartment must not come into contact with the door glass. This could cause permanent discolouration of the door glass.
- Water in a hot cooking compartment: do not pour water into the cooking compartment when it is hot. This will cause steam. The temperature change can cause damage to the enamel.
- Moisture in the cooking compartment: Over an extended period of time, moisture in the cooking compartment may lead to corrosion. Allow the cooking compartment to dry after use. Do not keep moist food in the closed cooking compartment for extended periods of time. Do not store food in the cooking compartment.
- Cooling with the appliance door open: Following operation at high temperatures, only allow the cooking compartment to cool down with the door closed. Do not trap anything in the appliance door. Even if the door is only left open a crack, the front of nearby furniture may become damaged over time. Only leave the cooking compartment to dry with the door open if a lot of moisture was produced whilst the oven was operating.
- Fruit juice: when baking particularly juicy fruit pies, do not pack the baking tray too generously. Fruit juice dripping from the baking tray leaves stains that cannot be removed. If possible, use the deeper universal pan.
- Extremely dirty seal: If the seal is very dirty, the appliance door will no longer close properly during operation. The fronts of adjacent units could be damaged. Always keep the seal clean.
- Appliance door as a seat, shelf or worktop: Do not sit on the appliance door, or place or hang anything on it. Do not place any cookware or accessories on the appliance door.
- Inserting accessories: depending on the appliance model, accessories can scratch the door panel when closing the appliance door. Always insert the accessories into the cooking compartment as far as they will go.
- Carrying the appliance: do not carry or hold the appliance by the door handle. The door handle cannot support the weight of the appliance and could break.

Environmental protection

Your new appliance is particularly energy-efficient. Here you can find tips on how to save even more energy when using the appliance, and how to dispose of your appliance properly.

Saving energy

- Only preheat the appliance if this is specified in the recipe or in the tables in the operating instructions.
- Use dark, black lacquered or enamelled baking tins. They absorb heat particularly well.
- Open the appliance door as infrequently as possible during operation.
- It is best to bake several cakes one after the other. The cooking compartment is still warm. This reduces the baking time for the second cake. You can place two cake tins next to each other in the cooking compartment.
- For longer cooking times, you can switch the appliance off 10 minutes before the end of the cooking time and use the residual heat to finish cooking.

Environmentally-friendly disposal

Dispose of packaging in an environmentally-friendly manner.



This appliance is labelled in accordance with European Directive 2012/19/EU concerning used electrical and electronic appliances (waste electrical and electronic equipment - WEEE). The guideline determines the framework for the return and recycling of used appliances as applicable throughout the EU.

Getting to know your appliance

In this chapter, we will explain the displays and controls. You will also find out about the various functions of your appliance.

Note: . Depending on the appliance model, individual details and colours may differ.

Control panel

In the control panel, set the appliance's different functions. The current settings are shown on the display.

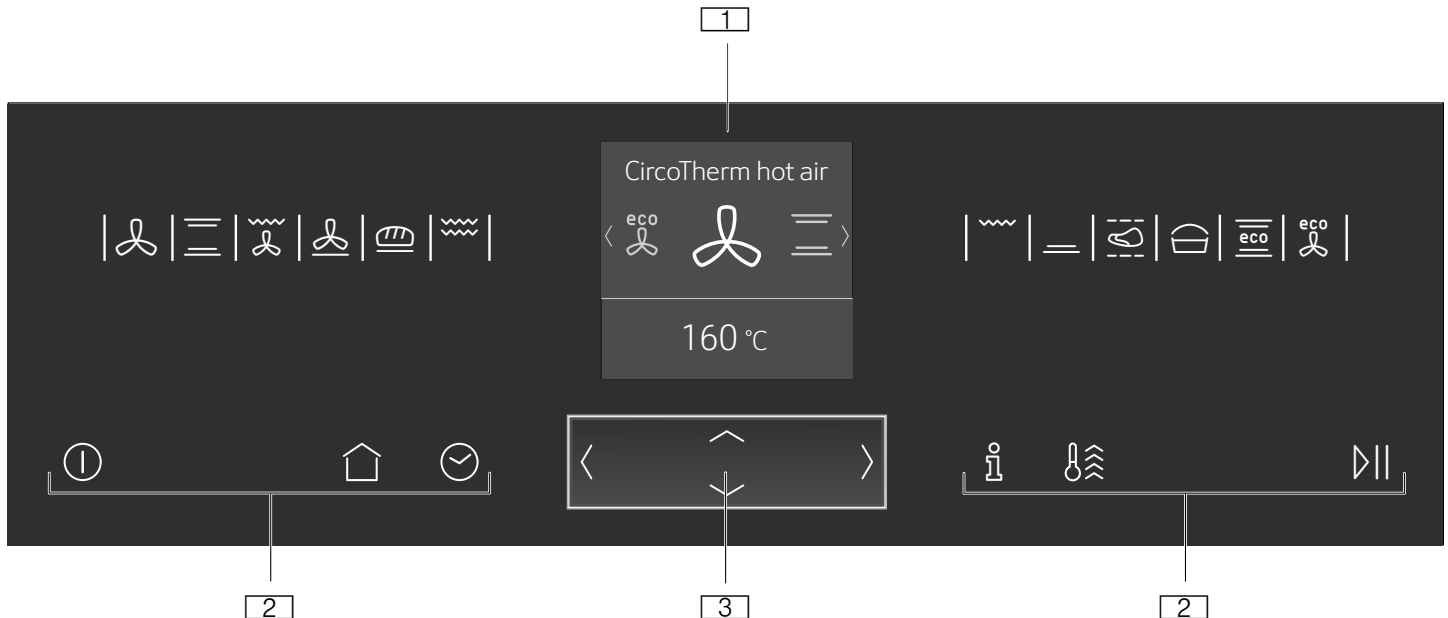

- 1 Display
- 2 Touch buttons
- 3 ShiftControl control

Controls

Use the controls to set your appliance simply and directly.

Touch buttons

There are sensors under the touch buttons. Touch on the corresponding touch button to select a function.

| Touch button | Use |
|------------------------|--|
| ⓘ on/off | Switching the appliance on or off → "Switching the appliance on and off" on page 12 |
| 🏠 Main menu | Selecting operating modes and settings → "Setting and starting the appliance operation" on page 12 |
| 🕒 Time-setting options | Setting the timer, cooking time, or "Ready at" start delay → "Time-setting options" on page 14 |
| 🔒 Childproof lock | Activating or deactivating the childproof lock → "Childproof lock" on page 15 |
| ℹ Information | Displaying further information Displaying the current temperature → "Setting and starting the appliance operation" on page 12 |

| | | |
|---|---------------|--|
| ⚡ | Rapid heating | Activating or deactivating rapid heating → "Heating up the appliance quickly" on page 13 Activating or deactivating Power-Boost → "Heating up the appliance quickly" on page 13 |
| ⏸ | Start/Stop | Starting or stopping the operation → "Setting and starting the appliance operation" on page 12 |

ShiftControl control

Use the ShiftControl control element to navigate through the lines on the display and select the settings. Settings that you can change have left and right arrows < >.



| Button | Use |
|--------|--|
| < | Left Navigates to the left on the display |
| > | Right Navigates to the right on the display |
| ^ | Up Navigates upwards on the display |
| v | Down Navigates downwards on the display |

Note: You can also scroll through the settings values quickly by pressing and holding a button. As soon as you release the button, you stop scrolling through the values quickly.

Main menu













Touch the  touch button to access the main menu.

| Menu | Use |
|--|--|
|  | Types of heating Selecting the required type of heating and temperature for your dish → "Switching the appliance on and off" on page 12 |

| | |
|---|---|
|  | Basic settings Individually adjusting the appliance settings → "Basic settings" on page 16 |
|  | Floor cleaning aid Cleaning the cooking compartment floor → "Cleaning function" on page 19 |
|  | EcoClean Cleaning the cooking compartment → "Cleaning function" on page 19 |

Menu for the types of heating

Your appliance has different types of heating. After switching on the appliance, you are taken directly to the menu for the types of heating.

| Type of heating | Temperature | Use |
|---|--------------|--|
|  CircoTherm hot air | 40 - 200 °C | For baking and cooking on one or more levels. The fan distributes the heat from the ring heating element in the back panel evenly around the cooking compartment. |
|  Top/bottom heating | 50 - 275 °C | For traditional baking and roasting on one level. Especially suitable for cakes with moist toppings. Heat is emitted evenly from the top and bottom. |
|  Circo-roasting | 50 - 250 °C | For roasting poultry, whole fish and larger pieces of meat. The grill element and the fan switch on and off alternately. The fan circulates the hot air around the food. |
|  Pizza setting | 50 - 275 °C | For preparing pizza and dishes which require a lot of heat from underneath. The bottom heating element and the ring heating element in the back panel heat up. |
|  Bread-baking | 180 - 240 °C | For baking bread, bread rolls and baked items that require high temperatures. |
|  Grill, large area | 50 - 290 °C | For grilling flat items, such as steaks or sausages, for making toast, and for au gratin dishes. The whole area below the grill element becomes hot. |
|  Grill, small area | 50 - 290 °C | For grilling small amounts of steaks or sausages, for making toast, and for au gratin dishes. The centre area under the grill heating element becomes hot. |
|  Bottom heating | 50 - 250 °C | For cooking in a bain marie and for the final baking stage. The heat is emitted from below. |
|  Slow cooking | 70 - 120 °C | For gentle and slow cooking of seared, tender pieces of meat in ovenware without a lid. The heat is emitted evenly from the top and bottom at low temperatures. |
|  Dough proving | 35 - 55 °C | For leaving yeast dough and sourdough to prove and for culturing yogurt. Dough will prove more quickly than at room temperature. The surface of the dough does not dry out. |
|  Top/bottom heating eco | 50 - 275 °C | For energy-optimised cooking of selected dishes. Heat is emitted evenly from the top and bottom. |
|  CircoTherm eco | 40 - 200 °C | For energy-optimised cooking of selected dishes on one level without preheating. The fan distributes the energy-optimised heat from the ring heating element in the back wall evenly around the cooking compartment. |

Cooking compartment functions

The functions in the cooking compartment make your appliance easier to use. This, for example, enables the cooking compartment to be well lit and a cooling fan to prevent the appliance from overheating.

Opening the appliance door

If you open the appliance door during an operation, the operation is paused. The operation continues to run when you close the door.

Note: For some types of heating, the operation continues to run even when the appliance door is open.

Interior lighting

If you open the appliance door, the interior lighting switches on. If the door remains open for longer than around 15 minutes, the lighting switches off again.

For most operating modes, the interior lighting switches on as soon as the operation is started. When the operation has finished, the lighting switches off.

Note: You can set the interior lighting not to come on during the operation in the basic settings. → "Basic settings" on page 16

Cooling fan

The cooling fan switches on and off as required. The hot air escapes above the door.

Caution!

Do not cover the ventilation slots. Otherwise, the appliance may overheat.

So that the cooking compartment cools down more quickly after the operation, the cooling fan continues to run for a certain period afterwards.

Note: You can change how long the cooling fan continues to run for in the basic settings. → "Basic settings" on page 16

Accessories

Your appliance is accompanied by a range of accessories. Here, you can find an overview of the accessories included and information on how to use them correctly.

Accessories included

Your appliance is equipped with the following accessories:



Only use genuine accessories. They are specially adapted for your appliance.

You can buy accessories from the after-sales service, from specialist retailers or online.

Note: The accessories may become deformed when they become hot. This does not affect their function. Once they cool down again, they regain their original shape.

Inserting accessories

The cooking compartment has four shelf positions. The shelf positions are counted from the bottom up.

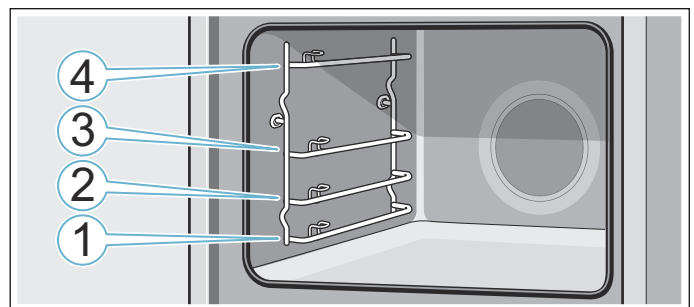

The accessories can be pulled out up to approximately halfway without tipping.

Notes

- Ensure that you always insert the accessories into the cooking compartment the right way round.
- Always insert the accessories fully into the cooking compartment so they do not touch the appliance door.

Locking function

The accessories can be pulled out approximately halfway until they lock in place. The locking function prevents the accessories from tilting when they are pulled out. The accessories must be inserted into the cooking compartment correctly for the tilt protection to work properly.

When inserting the wire rack, ensure that the lug **a** is at the rear and is facing downwards. The open side must be facing the appliance door and the curvature must be facing downwards ↘.

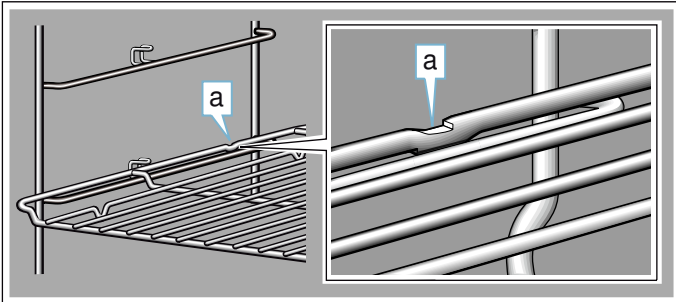

When inserting the baking tray or the universal pan, ensure that the lug **b** is at the rear and is facing downwards. The sloping edge of the accessory **c** must be facing towards the appliance door.

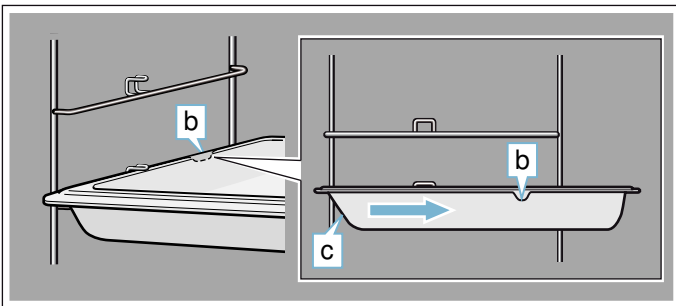

Combining accessories

You can insert the wire rack and the universal pan at the same time to catch drops of liquid.

When inserting the wire rack, ensure that both spacers **a** are at the rear edge. When the universal pan is inserted, the wire rack is on top of the upper guide rod of the shelf position.

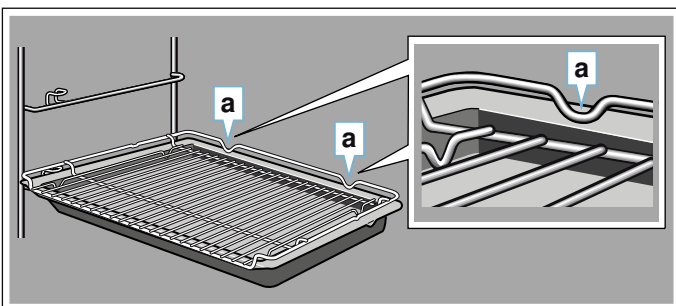

Optional accessories

You can purchase optional accessories from the after-sales service and specialist retailers, or on the Internet. You will find a comprehensive range of products for your appliance in our brochures and on the Internet.

Both availability and whether it is possible to order online differ between countries. Please see your sales documents for more details.

When purchasing, please always quote the exact order number of the optional accessory.

Note: Not all optional accessories are suitable for every appliance. When purchasing, please always quote the exact designation (E no.) of your appliance.

→ "Customer service" on page 24

| Accessories | Order number |
|-------------------------------------|--------------|
| Baking and roasting shelf | Z11CR10X0 |
| Baking tray | Z12CB10A0 |
| Universal pan | Z12CU10A0 |
| Baking tray, non-stick | Z11AB10A0 |
| Universal pan, non-stick | Z11AU10A0 |
| Extra-deep pan | Z12CM10A0 |
| Steaming set for ovens | Z19DD10X0 |
| Profi pan | Z12CN10A0 |
| Lid for the Profi pan | Z12CL10A0 |
| Pizza tray | Z1352X0 |
| Grill tray | Z12CQ10A0 |
| Ceramic brick | Z1913X0 |
| Glass roasting dish, 5.1 litres | Z11GT10X0 |
| Glass pan | Z11GU10X0 |
| ComfortFlex rail (1 level)* | Z11TC10X0 |
| 3 x fully extendable pull-out rack* | Z11TF36X0 |

* Accessory does not fit in every appliance, quote the E no. when ordering

Before using for the first time

Before you can use your new appliance, you must make some settings. You must also clean the cooking compartment and accessories.

Initial use

As soon as the appliance is connected to the power supply, the first setting "Language" appears on the display.

Setting the language

1. Use the \curvearrowright button to navigate to the bottom line.
2. Use the \langle or \rangle button to select the language.
3. Use the \curvearrowleft button to return to "Language".
4. Use the \rangle button to select the next setting.

Setting the time

1. Use the \curvearrowright button to navigate to the next line.
2. Use the \langle or \rangle button to select the current time.
3. Press the \curvearrowleft button.
4. Use the \rangle button to select the next setting.

Setting the date

1. Use the \curvearrowright button to navigate to the next line.
2. Use the \langle or \rangle button to select the current day.
3. Use the \curvearrowleft button to return to "Day".
4. Use the \rangle button to select the next setting.
5. Use the \curvearrowright button to navigate to the next line.
6. Use the \langle or \rangle button to select the current month.
7. Use the \curvearrowleft button to return to "Month".
8. Use the \rangle button to select the next setting.
9. Use the \curvearrowright button to navigate to the next line.
10. Use the \langle or \rangle button to select the current year.
11. Use the \curvearrowleft button to return to "Year".
12. Use the \rangle button to apply the settings.

The initial use is complete.

Notes

- You can change these settings at any time in the basic settings. → "Basic settings" on page 16
- After connecting the appliance to the power or following a power cut, the settings for initial use are shown in the display.

Cleaning the cooking compartment

To remove the new-appliance smell, heat up the cooking compartment when it is empty and with the oven door closed.

1. Remove the accessories from the cooking compartment.
2. Remove leftover packaging, such as polystyrene pellets, from the cooking compartment.
3. Before heating the appliance, wipe the smooth surfaces in the cooking compartment with a soft, wet cloth.
4. Use the Ⓢ touch button to switch on the appliance.
5. Set the heating type and temperature, then start the appliance operation. → "Setting and starting the appliance operation" on page 12

Settings

| | |
|--------------|-----------------------------|
| Heating type | Top/bottom heating \equiv |
| Temperature | 240 °C |
| Cooking time | 1 hour |

6. Keep the kitchen ventilated while the appliance is heating up.
7. Use the Ⓢ touch button to switch off the appliance after the indicated cooking time.
8. Wait until the cooking compartment has cooled down.
9. Clean the smooth surfaces with soapy water and a dish cloth.

Cleaning the accessories

Clean the accessories thoroughly using soapy water and a dish cloth or soft brush.

Operating the appliance

You have already learnt about the controls and how they work. Now we will explain how to set your appliance. You will learn about what happens when you switch the appliance on and off, and how to select the operating mode.

Switching the appliance on and off

Touch the  touch button to switch the appliance on or off.

After switching off the appliance, on the display you can see if the residual heat in the cooking compartment is high or low.



| Display | Meaning |
|---------|--|
| -H- | Residual heat high (above 120 °C) |
| -h- | Residual heat low (between 60 °C and 120 °C) |

Notes





- Certain displays and notes, such as the residual heat in the cooking compartment, remain visible on the display even when the appliance is switched off.
- After an appliance operation, the cooling fan runs on audibly until the cooking compartment has been cooled as far as possible.
- Switch off your device when you do not need to use it. If no settings are applied for a long time, the appliance switches itself off automatically.

Setting and starting the appliance operation

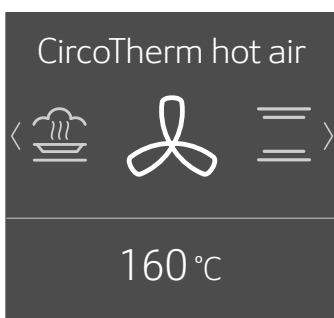

Example: CircoTherm hot air  at 170 °C

1. Touch the  touch button to switch on the appliance.
You are taken directly to the  menu for the types of heating.

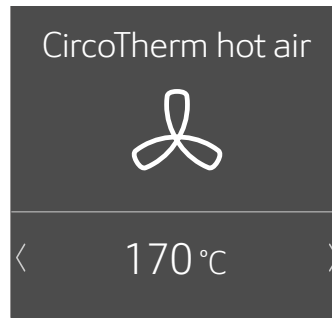

2. Use the  or  button to select the type of heating.
3. Use the  button to navigate to the next line.
4. Use the  or  button to select the temperature.



Note: Depending on the operating mode, different settings are available. For each further setting, use the  button to navigate to the next line. Use the  or  button to select the setting.

5. Touch the  touch button to start the appliance operation.
The heating bar and run time appear on the display.

Note: If you would like to go directly to the  main menu after switching on the appliance, you can select the main menu under "Operation after switching on" in the basic settings chapter. → "Basic settings" on page 16

Default values

The appliance suggests a temperature or setting for each type of heating. You can accept this value or change it in the appropriate area.

Heating bar

As soon as a type of heating has started, the heating bar appears on the display. The heating bar shows the temperature increase in the cooking compartment.

Run time



When a type of heating has been started, the run time is displayed. The run time counts upwards during the operation. You can therefore check how long the operation has already been running.

Displaying the current temperature

To show the current temperature on the display, press the  touch button.

The current temperature is shown briefly only when heating up.

Further information

If the  touch button lights up, information can be displayed. Touch the  touch button to do this. The information is displayed for a few seconds.

Changing or cancelling the appliance operation

Changing the appliance operation

1. Use the ▷|| button to stop the operation.
2. Use the ∨ or ∧ button to navigate to the line for the setting that should be changed.
3. Use the < or > button to change the setting.
4. Use the ▷|| touch button to start the changed operation.

Notes

- The cooling fan may continue to run while an operation is interrupted.
- After a temperature change, the paused running time continues to count. After a change in the type of heating, the running time starts again from zero.



Cancelling the appliance operation

Press and hold the ▷|| touch button until the appliance operation is cancelled.

Note: Operating modes such as the cleaning function cannot be cancelled.

Heating up the appliance quickly

You can use the "Rapid heat-up" and "PowerBoost" functions to reduce the preheat time. Whether the appliance is preheated with the "Rapid heat-up" function or the "PowerBoost" function depends on the type of heating that has been set. With the "PowerBoost" function, unlike with the "Rapid heat-up" function, you can place your food into the cold cooking compartment even before preheating has begun. Only cook on one level when using the "PowerBoost" function.

| Function | Type of heating | Place the food in the cooking compartment |
|---------------|--|---|
| Rapid heat-up | Top/bottom heating  | after preheating |
| PowerBoost* | CircoTherm hot air  Bread-baking setting  | before preheating |

* Do not use more than one level for cooking



Notes

- If the ⦿ touch button is lit, the "Rapid heat-up" or "PowerBoost" function can be activated.
- To deactivate the "Rapid heat-up" or "PowerBoost" function before it has finished, touch the ⦿ touch button.

Activating the "Rapid heat-up" function



1. Set top/bottom heating  and the temperature.
Note: Set a temperature above 100 °C to allow the appliance to preheat quickly.
2. Touch the ▷|| touch button to start the appliance operation.
3. Touch the ⦿ touch button to activate the "Rapid heat-up" function.
The ⦿ symbol appears on the display.
4. Once the set temperature has been reached, the "Rapid heat-up" function switches itself off automatically. The ⦿ symbol disappears from the display. Place the food in the cooking compartment

Activating the "PowerBoost" function

1. Set CircoTherm hot air  or the bread baking setting  and the temperature.
Note: Set a temperature above 100 °C to allow the appliance to preheat quickly.
2. Place the food on a single level in the cooking compartment.
3. Touch the ▷|| touch button to start the appliance operation.
4. Touch the ⦿ touch button to activate the "PowerBoost" function.
The ⦿ symbol appears on the display. Once the set temperature has been reached, the "PowerBoost" function switches itself off automatically. The ⦿ symbol disappears from the display.

Time-setting options

Your appliance has different time-setting options.

| Time-setting option | Use |
|---|--|
|  Timer | The timer functions like an egg timer. The appliance does not switch on and off automatically. |
|  Cooking time | Once the set cooking time has elapsed, the appliance switches off automatically. |
|  Ready at | The appliance switches on automatically, and once the set cooking time has elapsed and the end time has passed, it switches off automatically. |

Note: If you have set a time-setting option, the time interval increases if you set a higher value. Example: You can set a cooking time of up to one hour in one-minute increments; for cooking times over one hour, you can set a cooking time in five-minute increments.

Showing and hiding the time-setting options







To show or hide the time-setting options, touch the  touch button.

Note: After a particular length of time, the time-setting options that are shown are automatically hidden. If you have already set a cooking time, it will be applied.



Setting the timer







The timer can be set when the appliance is switched on or off.

1. Touch the  touch button.
The time-setting options are shown on the display.
2. Select the cooking time using the  button.
Note: When the appliance is switched on, use the  button to navigate to the Timer  line and then select the cooking time using the  button.
3. Touch the  touch button to start the timer.
The  symbol appears on the display. The timer counts down.

Note: As soon as the set time has elapsed, a signal sounds. To cancel the signal tone, touch the  touch button.

Setting the cooking time

Once the set cooking time has elapsed, the appliance switches off automatically. The function can only be used in combination with a type of heating.

1. Touch the  touch button.
2. Set the type of heating and temperature.
3. Touch the  touch button.
The time-setting options are shown in the display.
4. Use the  or  button to set the cooking time.
 - Default value for the  button = 10 minutes
 - Default value for the  button = 30 minutes
5. Touch the  touch button to start the set cooking time.







As soon as the cooking time has elapsed, an audible signal sounds and the appliance ends the operation automatically. Touch the  touch button to end the audible signal.

Start delay – "Ready at"

The appliance switches on automatically and switches off at the preset end time. To do this, set the cooking time and determine the end time for the operation.





The start delay can only be used in combination with a type of heating.

Notes

- Ensure that food is not left in the cooking compartment for too long as it may spoil.
 - It is not possible to start every type of heating with a start delay.
1. Slide food into the cooking compartment on a suitable accessory and close the appliance door.
 2. Touch the  touch button.
 3. Set the type of heating and temperature.
 4. Touch the  touch button.
The time-setting options are shown on the display.
 5. Select the cooking time using the  button.
 6. Use the  button to navigate to the " Ready at" line.
 7. Select the end time using the  button.
 8. Touch the  touch button.
The appliance waits until the appropriate time to start the operation.

As soon as the end time has passed, a signal sounds and the appliance stops the operation automatically. To cancel the signal tone, touch the  touch button.

Checking, changing or deleting settings



1. Touch the  touch button.
The time-setting options are shown on the display.
2. Use the  or  button to navigate through the lines.
3. If necessary, change the setting using the  or  button. Set "00:00" to delete a time function.
The setting is applied automatically.

Childproof lock

Your appliance is equipped with a childproof lock so that children cannot switch it on accidentally or change any settings.

Your appliance has two different locks.













| Lock | Activate/deactivate |
|---------------------------|--|
| Automatic childproof lock | Via the Settings menu → "Basic settings" on page 16 |
| One-time childproof lock | Via the  touch button |

Note: As soon as you activate the childproof lock, the control panel is locked. The  and  touch buttons are not included. You can deactivate the childproof lock at any time.



Automatic childproof lock

The control panel is locked so that the appliance cannot be switched on. To switch it on, the automatic childproof lock must be interrupted. After the appliance operation, the control panel is locked automatically.















Activating

1. Touch the  touch button.
2. Touch the  touch button.
3. Use the  or  button to select the "Settings".
4. Use the  button to navigate to the next line.
5. Use the  or  button to select "Automatic childproof lock".
6. Use the  button to navigate to the next line.
7. Use the  or  button to select "Activated".
8. Touch the  touch button.
9. Use the  button to navigate to the next line to save the setting.
The "Automatic childproof lock" is activated. The  symbol appears on the display after switching off the appliance.

Cancelling

1. Press and hold the  touch button until "Childproof lock deactivated" appears on the display.
2. Touch the  touch button.
3. Switch on the required appliance operation.



Deactivating

1. Press and hold the  touch button until "Childproof lock deactivated" appears on the display.
2. Touch the  touch button.
3. Touch the  touch button.
4. Use the  or  button to select the "Settings".
5. Use the  button to navigate to the next line.
6. Use the  or  button to select "Automatic childproof lock".
7. Use the  button to navigate to the next line.
8. Use the  or  button to select "Deactivated".
9. Touch the  touch button.
10. Use the  button to navigate to the next line to save the setting.
The "Automatic childproof lock" is deactivated.
11. Touch the  touch button.

One-time childproof lock

The control panel is locked so that the appliance cannot be switched on. To switch it on, the one-time childproof lock must be deactivated. After the appliance is switched off, the control panel is no longer locked.













Activating and deactivating

1. Press and hold the  touch button until "Childproof lock activated" appears on the display.
The childproof lock is activated.
2. Press and hold the  touch button until "Childproof lock deactivated" appears on the display.
The childproof lock is deactivated.

Basic settings

There are various settings available to you in order to help use your appliance effectively and simply. You can change these settings as required.

Changing the basic settings

1. Touch the  touch button.
2. Touch the  touch button.
3. Use the  or  button to select the "⚙ Settings".
4. Use the  button to navigate to the next line.
5. Use the  or  button to select the setting.
6. Use the  button to navigate to the next line.
7. Use the  or  button to select the setting.
8. Touch the  touch button.
9. To save the setting, use the  button to select "Save".
To discard the setting, use the  button to select "Discard".

List of basic settings













| Setting | Selection |
|---------------------------|--|
| Language | Select language |
| Time of day | Sets the current time |
| Date | Sets the current date |
| Favourites | Set the heating types that should be shown in the heating types menu → "Setting favourites" on page 16 |
| Audible signal duration | Short |
| | Medium |
| | Long |
| Button tone | Switched off (Exception: The button tone for the  touch button remains switched on) |
| | Switched on |
| Display brightness | Adjustable across 5 levels |
| Clock display | Digital |
| | Off |
| Lighting | On during operation |
| | Off during operation |
| Childproof lock* | Only key lock |
| | Door lock and key lock |
| Automatic childproof lock | Deactivated |
| | Activated |
| Action after switching on | Main menu |
| | Heating types |
| Night-time dimming | Switched off |
| | Switched on (display dimmed between 10 p.m. and 5.59 a.m.) |
| Brand name logo | Display |
| | Do not display |

| | |
|--|---|
| Fan run-on time | Recommended |
| | Minimum |
| Pull-out system | No |
| | Yes (double or triple pull-out system retro-fitted) |
| Factory settings | Load |
| *) Depending on the appliance model, this basic setting cannot be selected | |



Setting favourites

You can set which heating types are shown in the Types of heating menu.

Note: The "CircoTherm hot air", "Circo-roasting" and "Grill, large area" types of heating are always shown in the Types of heating menu. They cannot be deactivated.

1. Touch the  touch button.
2. Touch the  touch button.
3. Use the  or  button to select the "⚙ Settings".
4. Use the  button to navigate to the next line.
5. Use the  or  button to select "Favourites".
6. Use the  button to navigate to the next line.
7. Use the  or  button to select the type of heating.
8. Use the  button to navigate to the next line.
9. Use the  or  button to select "Activated" or "Deactivated".

Note: If you have selected "Activated", the type of heating is shown in the Types of heating menu. If you have selected "Deactivated", the type of heating is shown in the Types of heating menu.

10. Touch the  touch button.
11. To save the setting, use the  button to select "Save".
To discard the setting, use the  button to select "Discard".

Sabbath mode











You can set a time of up to 74 hours using Sabbath mode. The food in the cooking compartment remains warm, without you having to switch the appliance on or off.

Starting Sabbath mode

Before you can use Sabbath mode, you must activate it under "Favourites" in the basic settings. → "Setting favourites" on page 16

Once the Sabbath mode has been activated, you can select it under the menu for the types of heating.

The appliance heats up with top/bottom heating. The temperature can be set between 85 °C and 140 °C.

1. Touch the  touch button.
2. Use the  or  button to select "Sabbath mode".
3. Use the  button to navigate to the next line.
4. Use the  or  button to select the temperature.
5. Use the  button to navigate to the next line.
6. Use the  or  button to select the cooking time.
7. Touch the  touch button.

The appliance starts the operation.

Notes

- Once Sabbath mode has started, you can no longer change any settings or cancel the operation using the  touch button.
- The operation is not interrupted if you open the appliance door.

Once the Sabbath mode duration has elapsed, a signal sounds. The appliance stops heating. Use the  touch button to switch off the appliance.

Cancelling Sabbath mode

Touch the  touch button to cancel Sabbath mode.

Cleaning agent

With good care and cleaning, your appliance will retain its appearance and remain fully functioning for a long time to come. We will explain here how you should correctly care for and clean your appliance.

Suitable cleaning agents

To ensure that the different surfaces are not damaged by using the wrong cleaning agent, observe the information in the table. Depending on the appliance model, not all of the areas listed may be on/in your appliance.

Caution!

Risk of surface damage

Do not use:

- Harsh or abrasive cleaning agents,
- Cleaning agents with a high alcohol content,
- Hard scouring pads or cleaning sponges,
- High-pressure cleaners or steam cleaners,
- Special cleaners for cleaning the appliance while it is hot.

Wash new sponge cloths thoroughly before use.

Tip: Highly recommended cleaning and care products can be purchased through the after-sales service. Observe the respective manufacturer's instructions.

Warning

Risk of burns!

The appliance becomes very hot. Never touch the interior surfaces of the cooking compartment or the heating elements. Always allow the appliance to cool down. Keep children at a safe distance.

| Area | Cleaning |
|---------------------------|--|
| Appliance exterior | |
| Stainless steel front | Hot soapy water: Clean with a dish cloth and then dry with a soft cloth. Remove flecks of limescale, grease, starch and albumin (e.g. egg white) immediately. Corrosion can form under such flecks. Special stainless steel cleaning products suitable for hot surfaces are available from our after-sales service or from specialist retailers. Apply a very thin layer of the cleaning product with a soft cloth. |
| Plastic | Hot soapy water: Clean with a dish cloth and then dry with a soft cloth. Do not use glass cleaner or a glass scraper. |
| Painted surfaces | Hot soapy water: Clean with a dish cloth and then dry with a soft cloth. |
| Control panel | Hot soapy water: Clean with a dish cloth and then dry with a soft cloth. Do not use glass cleaner or a glass scraper. |

| | |
|--|--|
| Door panels | Hot soapy water: Clean with a dish cloth and then dry with a soft cloth. Do not use a glass scraper or a stainless steel scouring pad. |
| Door handle | Hot soapy water: Clean with a dish cloth and then dry with a soft cloth. If descaler comes into contact with the door handle, wipe it off immediately. Otherwise, any stains will not be able to be removed. |
| Appliance interior | |
| Enamel surfaces and self-cleaning surfaces | Observe the instructions for the surfaces of the cooking compartment that follow the table. |
| Glass cover for the interior lighting | Hot soapy water: Clean with a dish cloth and then dry with a soft cloth. If the cooking compartment is heavily soiled, use oven cleaner. |
| Door seal Do not remove. | Hot soapy water: Clean with a dish cloth. Do not scour. |
| Stainless steel door cover | Stainless steel cleaner: Observe the manufacturer's instructions. Do not use stainless steel care products. Remove the door cover for cleaning. |
| Rails | Hot soapy water: Soak and clean with a dish cloth or brush. |
| Pull-out system | Hot soapy water: Clean with a dish cloth or a brush. Do not remove the lubricant while the pull-out rails are pulled out – it is best to clean them when they are pushed in. Do not clean in the dishwasher. |
| Accessories | Hot soapy water: Soak and clean with a dish cloth or brush. If there are heavy deposits of dirt, use a stainless steel scouring pad. |

Notes

- Slight differences in colour on the front of the appliance are caused by the use of different materials, such as glass, plastic and metal.
- Shadows on the door panels, which look like streaks, are caused by reflections made by the interior lighting.
- Enamel is baked on at very high temperatures. This can cause some slight colour variation. This is normal and does not affect operation. The edges of thin trays cannot be completely enamelled. As a result, these edges can be rough. This does not impair the anti-corrosion protection.

Surfaces in the cooking compartment

The back wall, ceiling and side parts in the cooking compartment are self-cleaning. You can tell this from the rough surface.

The cooking compartment floor is enamelled and has smooth surfaces.

Cleaning enamel surfaces

Clean the smooth enamel surfaces with a dish cloth and hot soapy water or a vinegar solution. Then dry with a soft cloth.

Soften baked-on food residues with a damp cloth and soapy water. If there are heavy deposits of dirt, use a stainless steel scouring pad or oven cleaner.

Leave the cooking compartment open to dry after cleaning.

Tip: It is best to use the cleaning aid. → "Cleaning function" on page 19

Cleaning self-cleaning surfaces

The self-cleaning surfaces are coated with a porous, matte ceramic layer. This coating absorbs and dispels splashes from baking and roasting while the appliance is in operation.

If the self-cleaning surfaces no longer clean themselves sufficiently and dark stains appear, they can be cleaned using the cleaning function. To do this, refer to the information in the relevant section. → "Cleaning function" on page 19

Caution!

Do not use oven cleaner on self-cleaning surfaces. This will damage the surfaces. If oven cleaner does get onto these surfaces, dab it off immediately using water and a sponge cloth. Do not rub the surface and do not use abrasive cleaning aids.

Keeping the appliance clean

Always keep the appliance clean and remove dirt immediately so that stubborn deposits of dirt do not build up.

Tips

- Clean the cooking compartment after each use. This will ensure that dirt cannot be baked on.
- Always remove flecks of limescale, grease, starch and albumin (e.g. egg white) immediately.
- Use the universal pan for baking very moist cakes.
- Use suitable ovenware for roasting, e.g. a roasting dish.
- Where possible, use Circotherm hot air. This type of heating creates less dirt.

Cleaning function

Your appliance is equipped with EcoClean and the floor cleaning aid. The self-cleaning surfaces in the cooking compartment are cleaned with the "EcoClean" cleaning function. Use the floor cleaning aid for intermediate cleaning of the cooking compartment floor. Dirt is softened beforehand using the floor cleaning aid. It can then be removed more easily.

EcoClean

The self-cleaning surfaces in the cooking compartment are cleaned with the "EcoClean" operating mode.

The self-cleaning surfaces (back panel, ceiling panel and side panels) are coated with a porous, matt ceramic material. This coating absorbs and breaks down splashes from baking, roasting and grilling while the oven is in operation. If the surfaces no longer clean themselves adequately and dark patches appear, the surfaces can be cleaned by the cleaning function.

Note: The appliance records the number of times it is used. The appliance indicates when it has reached a point in time after which cleaning is recommended. The recommendation is displayed until the cleaning function has finished.

If you do not act on this recommendation, the self-cleaning surfaces may become damaged. If your appliance is already prematurely very dirty or if you notice dark patches on the back panel, do not wait until your appliance recommends cleaning to do so. This is because the more often the appliance is cleaned, the longer the self-cleaning surfaces will retain their cleaning capability. You can clean your appliance at any time as required using the cleaning function.

Prior to initiating the cleaning function

Remove shelves, rails, accessories and ovenware from the cooking compartment.

Cleaning the cooking compartment floor and the inside of the appliance door

Remove the worst dirt from the cooking compartment floor, the inside of the appliance door and the interior lighting. Otherwise, patches will appear that can no longer be removed.









Caution!

Do not use oven cleaner on the self-cleaning surfaces. This will damage the surfaces. If oven cleaner does come into contact with these surfaces, dab it off immediately with water and a sponge cloth. Please do not rub or use any abrasive cleaning materials.

Starting

Before setting the cleaning function, ensure that you have followed all instructions for preparation.

The duration for the cleaning function is preset to 1 hour. It cannot be changed.

1. Touch the  touch button.
2. Touch the  touch button.
3. Use the  or  button to select "EcoClean .
4. Use the  button to navigate to the next line. The cleaning time with EcoClean is displayed.
5. Use the  button to navigate to the next line.
6. Touch the  touch button. The appliance starts EcoClean. The remaining time appears on the display.

Keep the kitchen ventilated while the cleaning function is running.

As soon as the cleaning aid has finished, an audible signal sounds and the appliance ends the operation automatically.

Once the cleaning function has ended

Once the cooking compartment has cooled down, wipe down the cooking compartment with a damp cloth if necessary.

Note: . During operation and while the cleaning function is active, reddish patches may form on the surfaces. This is not rust, but food residues. These patches are not hazardous to your health and do not limit the cleaning capacity of the self-cleaning surfaces.

Floor cleaning aid

The floor cleaning aid makes it easier to clean the cooking compartment floor. Dirt is softened beforehand by vaporizing soapy water. It can then be removed more easily.









Warning

Risk of scalding!

Water in a hot cooking compartment may create hot steam. Never pour water into the hot cooking compartment.

Starting

Notes

- The "Floor cleaning aid " cleaning aid can only be started once the cooking compartment is cold (room temperature) and the appliance door is closed.
 - Do not open the appliance door during operation. Doing this will interrupt the "Floor cleaning aid " cleaning aid.
1. Remove the accessories from the cooking compartment.
 2. Mix 0.4 litres of water (not distilled water) with a drop of washing-up liquid and pour into the middle of the cooking compartment floor.
 3. Touch the  touch button.
 4. Touch the  touch button.
 5. Use the  or  button to select "Floor cleaning aid .
 6. Use the  button to navigate to the next line.
 7. Touch the  touch button. The appliance starts the floor cleaning aid. The remaining time appears on the display.

Finishing

As soon as the cleaning aid has finished, an audible signal sounds and the appliance ends the operation automatically.

As soon as you open the appliance door, the interior lighting is switched on so that you can finish cleaning the cooking compartment more easily. The remaining water in the cooking compartment must be removed promptly. Do not leave the remaining water in the cooking compartment for a long time (e.g. overnight). The appliance must not be operated when the cooking compartment is still wet or damp.

Final cleaning

1. Open the appliance door and remove the remaining water with an absorbent sponge cloth.
2. Clean the smooth surfaces in the cooking compartment with a dish cloth or a soft brush. Stubborn residues can be removed using a stainless steel scouring pad.
3. Remove limescale with a cloth soaked in vinegar. Then wipe with clean water and rub dry with a soft cloth (including under the door seal).
4. Use the  touch button to switch off the appliance.
5. Leave the appliance door ajar in the locking position (approx. 30°) for approx. 1 hour to allow the enamel surfaces in the cooking compartment to dry. Alternatively, you can also run the rapid drying function for the cooking compartment.

Running the rapid drying function for the cooking compartment

1. After the cleaning aid process has finished, leave the appliance door ajar in the locking position (approx. 30°).
2. Touch the  touch button.
3. Start CircoTherm hot air at 50 °C.
4. After 5 minutes, switch off the appliance and close the appliance door.

Removing heavy deposits of dirt

You have several options for removing particularly stubborn deposits of dirt.

- Leave the soapy water to work for some time before starting the cleaning aid.
- Rub soapy water onto the dirt on the smooth surfaces before starting the cleaning aid.
- Repeat the cleaning aid once the cooking compartment has cooled down.

Rails

With good care and cleaning, your appliance will retain its appearance and remain fully functional for a long time to come. This will tell you how to remove the shelves and clean them.

Detaching and refitting the rails

Warning

Risk of burns!

The rails become very hot. Never touch the hot rails. Always allow the appliance to cool down. Keep children away from the appliance.

Detaching the rails

1. Lift the rail slightly at the front **a** and detach it **b** (figure **1**).
2. Then pull the whole rail towards you and take it out (figure **2**).

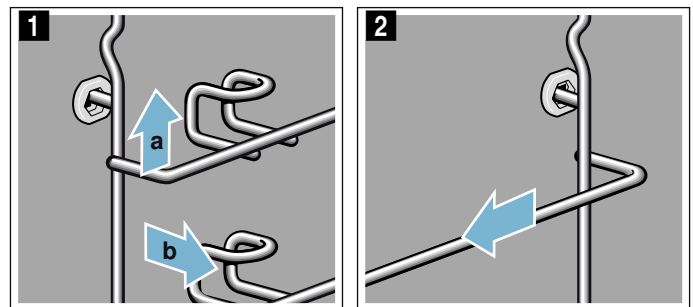

Clean the rails with cleaning agent and a sponge. For stubborn deposits of dirt, use a brush.

Attaching the rails

The rails only fit on the right or the left side. For both rails, ensure that the retaining bracket is at the front.

1. First, insert the rail in the middle of the rear socket **a**, until the rail rests against the cooking compartment wall, and push it back **b** (figure **1**).
2. Then insert the rail into the front socket **c**, until the rail also rests against the cooking compartment wall here, and press it downwards **d** (figure **2**).

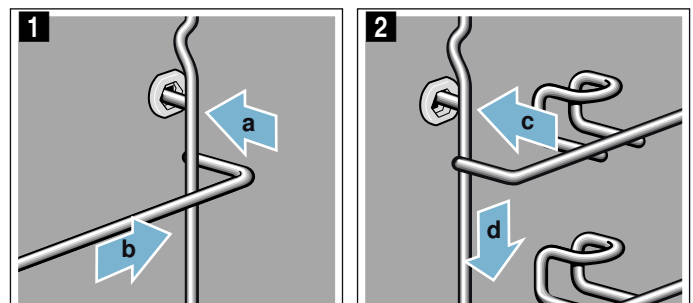

Appliance door

With good care and cleaning, your appliance will retain its appearance and remain fully functional for a long time to come. This will tell you how to remove the appliance door and clean it.

Removing and fitting the appliance door

For cleaning purposes and to remove the door panels, you can detach the appliance door.

The appliance door hinges each have a locking lever. When the locking levers are closed (figure 1), the appliance door is secured in place. It cannot be detached.

When the locking levers are open in order to detach the appliance door (figure 2), the hinges are locked. They cannot snap shut.

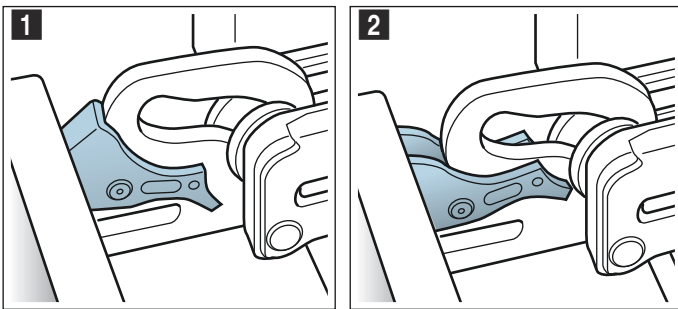

Warning Risk of injury!

- If the hinges are not locked, they can snap shut with great force. Ensure that the locking levers are always fully closed or, when detaching the appliance door, fully open.
- The hinges on the appliance door move when opening and closing the door, and you may be trapped. Keep your hands away from the hinges.

Removing the appliance door

1. Open the appliance door fully and push it in the direction of the appliance.
2. Fold up the two locking levers on the left and right (figure 1).
3. Close the appliance door as far as it goes **a**. With both hands, grip the door on the left- and right-hand side and pull it up and out (figure 2).

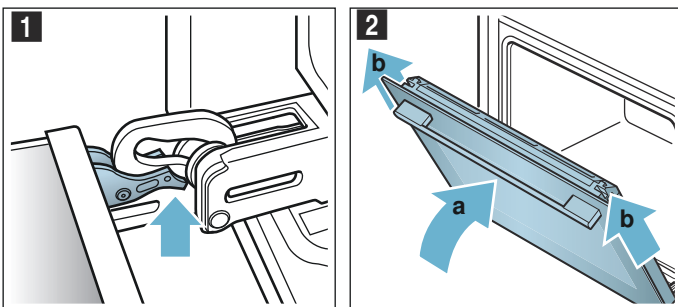

Fitting the appliance door

Reattach the appliance door in the opposite sequence to removal.

1. When attaching the appliance door, ensure that both hinges are inserted straight into the opening (figure 1). Place both hinges at the bottom on the outer panel and use this as a guide. Ensure that the hinges are inserted into the correct opening. You must be able to insert them easily and without resistance. If you can feel any resistance, check that the hinges are inserted into the correct opening.

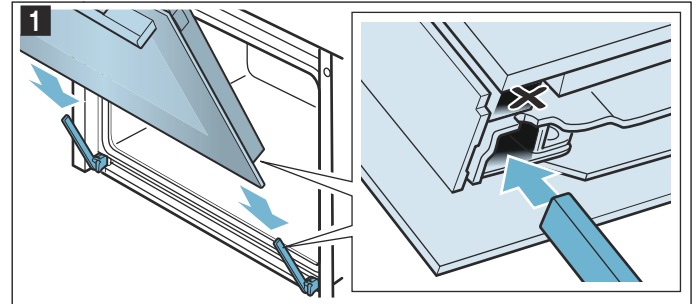

2. Open the appliance door fully. Fold both locking levers closed again (figure 2).

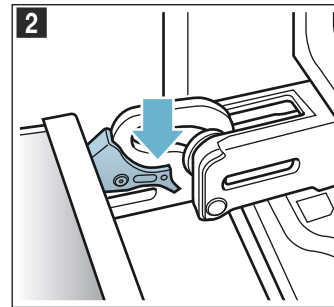

3. Close the cooking compartment door.

Removing the door cover

The stainless steel inlay in the door cover may become discoloured. To carry out thorough cleaning, you can remove the cover.

1. Open the appliance door slightly.
2. Press on the right and left side of the cover (figure 1).
3. Remove the cover (figure 2). Close the appliance door carefully.

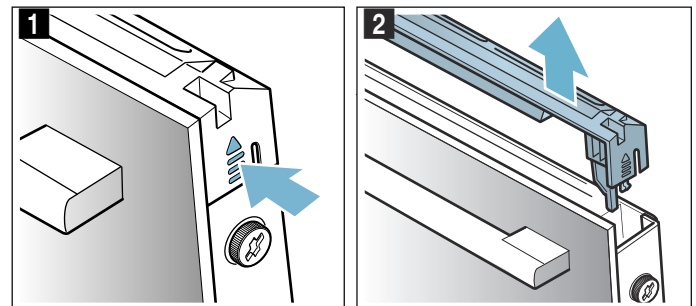

Note: Clean the stainless steel inlay in the cover with stainless steel cleaner. Clean the rest of the door cover with soapy water and a soft cloth.

4. Open the appliance door again slightly. Put the cover back in place and press on it until it clicks audibly into place (figure 3).

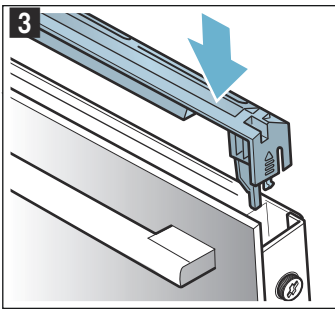

5. Close the appliance door.

Removing and installing the door panels

To facilitate cleaning, you can remove the glass panels from the appliance door.

Removing the door from the appliance

1. Open the appliance door slightly.
2. Press on the right and left side of the cover (figure 1).
3. Remove the cover (figure 2).

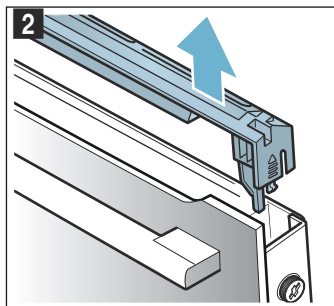
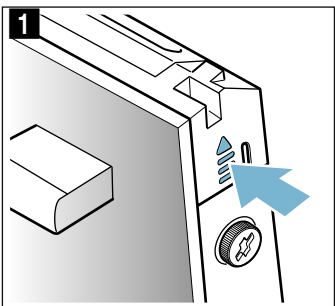

4. Loosen and remove the screws on the left and right of the appliance door (figure 3).
5. Before closing the door again, trap a tea towel which has been folded several times in the door (figure 4). Pull out the front panel upwards and lay it on a flat surface with the door handle facing downwards.

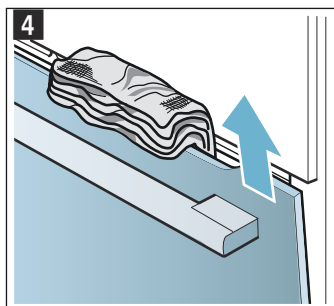
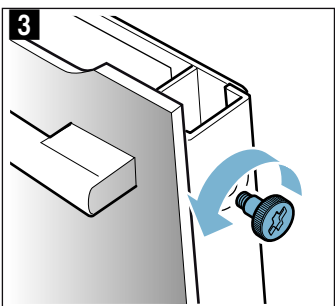

Clean the panels with glass cleaner and a soft cloth.

Warning

Risk of injury!

- Scratched glass in the appliance door may develop into a crack. Do not use a glass scraper, sharp or abrasive cleaning aids or detergents.
- The hinges on the appliance door move when opening and closing the door, and you may be trapped. Keep your hands away from the hinges.

Fitting the door on the appliance

1. Insert the front panel at the bottom into the retainers (figure 1).
2. Close the front panel until both upper hooks are opposite the opening (figure 2).

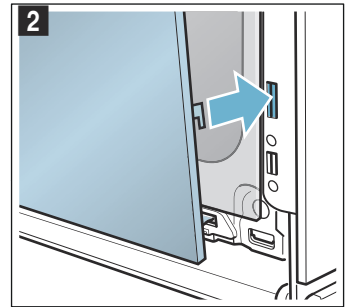
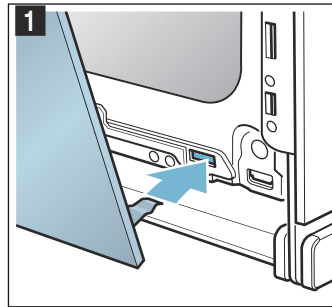

3. Press the front panel at the bottom until it clicks audibly into place (figure 3).
4. Open the appliance door again slightly and remove the tea towel.
5. Screw both screws back in on the left and right.
6. Put the cover back in place and press on it until it clicks audibly into place (figure 4).

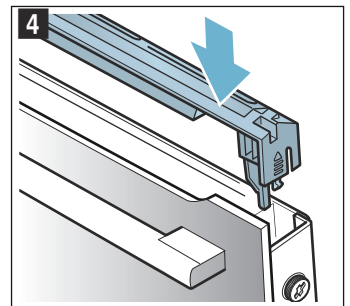
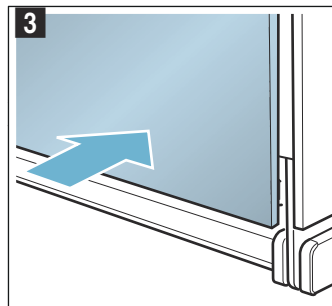

7. Close the appliance door.

Caution!

Do not use the cooking compartment again until the panels have been correctly fitted.

Trouble shooting

If a fault occurs, there is often a simple explanation. Before calling the after-sales service, please refer to the fault table and attempt to correct the fault yourself.

Tip: If a meal does not turn out exactly as you wanted, refer to the "Tested for you in our cooking studio" section. Here, you will find plenty of cooking tips and notes.

Warning

Risk of electric shock!







Incorrect repairs are dangerous. Repairs may only be carried out and damaged power cables replaced by one of our trained after-sales technicians. If the appliance is defective, unplug the appliance from the mains or switch off the circuit breaker in the fuse box. Contact the after-sales service.

Fault table

Warning

Risk of electric shock!

- Work on the appliance electronics may only be performed by a specialist.
- Always disconnect the appliance from the power supply when work is carried out on the electronics. Switch off the circuit breaker or remove the fuse from your household fuse box.

| Fault | Possible cause | Notes/remedy |
|---|--|---|
| The appliance does not work | The plug is not plugged into the mains | Connect the appliance to the power supply |
| | Power cut | Check whether other kitchen appliances are working |
| | The circuit breaker is faulty | Check in the fuse box to make sure that the fuse for the appliance is OK |
| After switching on an operating mode, a message is shown on the display which indicates that the temperature is too high | The appliance has not cooled down sufficiently | Allow the appliance to cool down and switch the operating mode on again |
| The appliance cannot be switched on; the  symbol is shown on the display | The automatic childproof lock is activated | Press and hold the  touch button until the  symbol goes out |
| The appliance cannot be operated when it is switched on; the  symbol is shown on the display | The childproof lock is activated | Press and hold the  touch button until the  symbol goes out |
| The appliance does not heat up;  is shown on the display | Demo mode is activated in the basic settings | Disconnect the appliance from the mains for approx. 10 seconds (switch off the circuit breaker in the fuse box) and then deactivate demo mode in the basic settings within 3 minutes → "Basic settings" on page 16 |
| "EXXXX" appears on the display, e.g. "E0111" | Technical problem | Switch the appliance off and back on again If the message appears again, call the after-sales service |

Maximum operating time exceeded

Your appliance ends the operation automatically when no cooking time is set and the setting has not been changed for a long time.

The actual cooking time until the operation is stopped automatically varies according to the selected settings.

The appliance display indicates that the operation will end automatically. Afterwards, the operation is stopped.

To use the appliance again, switch it off beforehand. Then switch the appliance on again and set the required operation.

Replacing the bulb in the top of the cooking compartment

If the cooking compartment light bulb fails, it must be replaced. Heat-resistant, 40 watt, 230 V halogen bulbs are available from the after-sales service or specialist retailers.

When handling the halogen bulb, use a dry cloth. This will increase the service life of the bulb. Only use these bulbs.

⚠ Warning

Risk of electric shock!

When replacing the cooking compartment bulb, the bulb socket contacts are live. Before replacing the bulb, unplug the appliance from the mains or switch off the circuit breaker in the fuse box.

⚠ Warning

Risk of burns!

The appliance becomes very hot. Never touch the interior surfaces of the cooking compartment or the heating elements. Always allow the appliance to cool down. Keep children at a safe distance.

- Place a tea towel in the cold cooking compartment to prevent damage.
- Turn the glass cover anti-clockwise to remove it (figure 1).
- Pull out the bulb – do not turn it (figure 2). Insert the new bulb, making sure that the pins are in the correct position. Push the bulb in firmly.

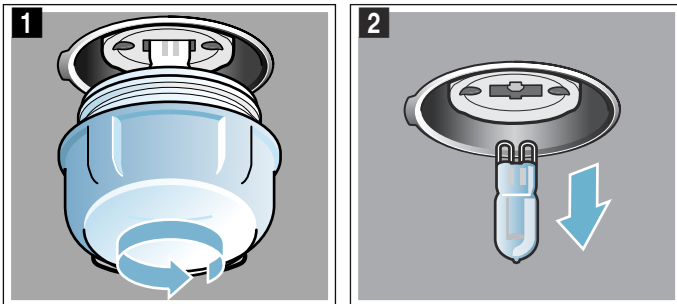

- Screw the glass cover back in.
- Remove the tea towel and switch on the circuit breaker.

Glass cover

If the glass cover of the halogen bulb is damaged, it must be replaced. You can obtain a new glass cover from the after-sales service. Please specify the E number and FD number of your appliance.

Customer service

Our after-sales service is there for you if your appliance needs to be repaired. We will always find an appropriate solution, also in order to avoid after-sales personnel having to make unnecessary visits.

E number and FD number

When calling us, please give the full product number (E no.) and the production number (FD no.) so that we can provide you with the correct advice. The rating plate bearing these numbers can be found when you open the appliance door.

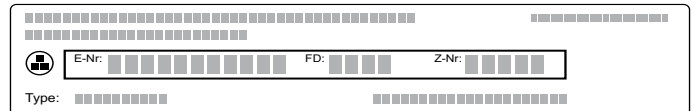

To save time, you can make a note of the number of your appliance and the telephone number of the after-sales service in the space below, should it be required.

| | |
|--------------|---------------|
| E no. | FD no. |
|--------------|---------------|

After-sales service ☎

Please note that a visit from an after-sales service engineer is not free of charge, even during the warranty period.

Please find the contact data of all countries in the enclosed customer service list.

To book an engineer visit and product advice

- GB** 0344 892 8989
Calls charged at local or mobile rate.
- IE** 01450 2655
0.03 € per minute at peak. Off peak 0.0088 € per minute.

Rely on the professionalism of the manufacturer. You can therefore be sure that the repair is carried out by trained service technicians who carry original spare parts for your appliances.

Tested for you in our cooking studio

Here, you can find a selection of dishes and the ideal settings for them. We will show you which type of heating and temperature are best suited to your dish. You will get information on suitable cooking accessories and the height at which they should be placed in the oven. You will also get tips about cookware and preparation methods.

Note: A lot of steam can build up in the cooking compartment when cooking food. Your appliance is very energy-efficient and radiates very little heat to its surroundings during operation. Due to the high difference in temperature between the appliance interior and the external parts of the appliance, condensation may build up on the door, control panel or adjacent kitchen cabinet panels. This is a normal physical phenomenon. Condensation can be reduced by preheating the oven or opening the door carefully.

Silicone moulds

For the best cooking results, we recommend dark-coloured metal baking tins/dishes.

Nevertheless, if you wish to use silicone moulds, follow the manufacturer's instructions and recipes. Silicone moulds are often smaller than normal baking tins. Quantity and recipe specifications may vary.

Baking

Here, you can find recommended settings for many dishes.

Also refer to the notes in the section on allowing dough to rise.

Only use original accessories supplied with your appliance. These have been tailored to the cooking compartment and the operating modes of your appliance.

Shelf positions

Use the indicated shelf positions.

Baking on one level

When baking on one level, use the following shelf positions:

- Tall baked items: Level 2
- Flat baked items: Level 3

If you are using CircoTherm Hot air as the type of heating, you can choose between levels 1, 2, 3 and 4.

You can also prepare soufflés in a water bath in the universal pan. To do so, slide the universal pan in at level 2.

Baking on two levels

Use CircoTherm. Baked items that are placed into the oven on trays or in baking tins/dishes at the same time will not necessarily be ready at the same time.

- Universal pan: Level 3
Baking tray: Level 1
- Baking tins/dishes on the wire rack
First wire rack: Level 3
Second wire rack: Level 1

By preparing several dishes at the same time, you can make energy savings of up to 45 per cent. Position baking tins/dishes next to one another or offset and vertically stacked in the cooking compartment.

Accessories

Ensure that you always use suitable accessories and that they are placed in the oven the right way around.

Wire rack

Insert the wire rack with the open side facing the appliance door and the outer rail pointing downwards.

Universal pan or baking tray

Slide the universal pan or the baking tray in carefully as far as the limit stop with the bevelled edge facing the appliance door.

When baking moist cakes or pastries with many toppings, use the universal pan so that any excess liquid does not overflow and make the cooking compartment dirty.

Baking tins

Dark- coloured metal baking tins are most suitable.

Tinplate baking tins, ceramic dishes and glass dishes extend baking time and mean that the baked item will not brown evenly. If you wish to bake using these baking tins/dishes and using top/bottom heating, slide in the tin/dish at level 1.

Greaseproof paper

Only use greaseproof paper that is suitable for the selected temperature. Always cut greaseproof paper to size.

Recommended setting values

You can find the ideal heating type for various pastries in the table. The temperature and baking time are dependent on the quantity and composition of the dough. Different settings ranges are indicated for this reason. Try using the lower values at first. A lower temperature results in more even browning. If necessary, use a higher setting the next time.

Note: Baking times can not be reduced by using higher temperatures. Cakes or small baked items would only be cooked on the outside, and would not be fully baked in the middle.





The setting values apply to dishes placed into a cold cooking compartment. By doing so, you can make energy savings of up to 20 per cent. If you preheat the oven, you can reduce the indicated baking times by several minutes.





































Preheating is necessary for selected dishes, and this is indicated in the table.

If you wish to follow one of your own recipes when baking, you should use a similar baked item in the table as a reference. You can find additional information in the tips on baking attached to the settings table.











Remove unused accessories from the cooking compartment. This will achieve the best possible cooking results and energy savings of up to 20 per cent.

Types of heating used:

-  CircoTherm hot air
-  Top/bottom heating
-  Pizza setting
-  Bread baking setting

| Dish | Accessories/cookware | Shelf position | Type of heating | Temperature in °C | Cooking time in mins. |
|--------------------------------|---------------------------------|----------------|---|-------------------|-----------------------|
| One level baking | | | | | |
| Victoria sponge cake | 2x Ø20 cm tins | 2 |  | 160-170* | 25-30 |
| Light fruit cake | high Ø20 cm tin | 2 |  | 140-160* | 70-90 |
| Rich fruit cake | high Ø23 cm tin | 2 |  | 130-150 | 150-180 |
| Fruit crumble | flat glass dish | 3 |  | 150-170* | 35-45 |
| Sponge Cake (fatless), 3 eggs | springform cake tin Ø26 cm | 2 |  | 160-170* | 25-35 |
| Sponge flan, 6 eggs | springform cake tin Ø28 cm | 2 |  | 150-170* | 30-50 |
| Swiss roll | swiss roll tin | 3 |  | 180-190* | 10-15 |
| Fruit Pie | plate Ø20 cm or pie tin | 2 |  | 160-170* | 55-65 |
| Fruit Pie | plate Ø20 cm or pie tin | 2 |  | 170-190* | 55-70 |
| Quiche | quiche tin (dark coated) | 3 |  | 190-210 | 30-40 |
| (White) Bread | loaf tin (1x 900 g or 2x 450 g) | 2 |  | 190-210* | 25-40 |
| (White) Bread | loaf tin (1x 900 g or 2x 450 g) | 2 |  | 180-200* | 20-30 |
| Scones | baking tray | 3 |  | 180-200* | 10-14 |
| Scones | baking tray | 3 |  | 190-200 | 10-14 |
| Biscuits | baking tray | 3 |  | 140-160* | 10-25 |
| Biscuits | baking tray | 3 |  | 150-170 | 10-20 |
| Small Cakes | 12-cup-tin | 3 |  | 140-160* | 20-30 |
| Small Cakes | 12-cup-tin | 3 |  | 150-170 | 20-30 |
| Puff pastry slices | baking tray | 3 |  | 170-190* | 20-35 |
| Jam tarts | 12-cup-tin | 3 |  | 170-190* | 15-30 |
| Jam tarts | 12-cup-tin | 3 |  | 180-200 | 15-25 |
| Meringue | baking tray | 3 |  | 80-90* | 120-150 |
| Pavlova | baking tray | 3 |  | 90-100* | 120-180 |
| Soufflé | 1,2L-soufflé dish | 2 |  | 160-170* | 35-45 |
| Soufflé | individual moulds | 2 |  | 170-190 | 65-75 |
| Choux pastry | baking tray | 3 |  | 190-210* | 30-40 |
| Meat Pie | rectangular pie tin | 2 |  | 190-200 | 30-45 |
| Meat Pie | rectangular pie tin | 2 |  | 170-190 | 50-70 |
| Yorkshire pudding | 12-cup-tin | 3 |  | 200-220* | 15-25 |
| Jacket potatoes | baking tray | 3 |  | 150-170 | 75-90 |
| Pizza, homemade | baking tray | 3 |  | 200-220 | 25-35 |
| Pizza, homemade | baking tray | 3 |  | 200-220 | 25-35 |
| Pizza, homemade, thin base | pizza tray | 2 |  | 250-270 | 20-25 |
| Pizza, homemade, thin base | pizza tray | 2 |  | 210-220 | 25-30 |
| Multishelf baking | | | | | |
| Victoria Sponge Cake, 2 levels | 4x Ø20 cm tins | 3+1 |  | 160-170* | 25-35 |
| Scones, 2 levels | 2 baking trays | 3+1 |  | 170-190* | 12-16 |

* Preheat

| Dish | Accessories/cookware | Shelf position | Type of heating | Temperature in °C | Cooking time in mins. |
|------------------------------|-----------------------------|----------------|---|-------------------|-----------------------|
| Biscuits, 2 levels | 2 baking trays | 3+1 |  | 140-160* | 10-25 |
| Biscuits, 3 levels | 3 baking trays | 4+3+1 |  | 140-160* | 15-30 |
| Small cakes, 2 levels | 2x 12-cup-tins | 3+1 |  | 140-160* | 22-32 |
| Puff pastry slices, 2 levels | 2 baking trays | 3+1 |  | 170-190* | 25-45 |
| Puff pastry slices, 3 levels | 3 baking trays | 4+3+1 |  | 170-190* | 25-45 |
| Jam tarts, 2 levels | 2x 12-cup-tins | 3+1 |  | 170-190* | 20-35 |
| Meringues, 2 levels | 2 baking trays | 3+1 |  | 80-90* | 120-150 |
| Jacket potatoes, 2 levels | universal pan + baking tray | 3+1 |  | 150-170* | 75-90 |
| (White) Bread, 2 levels | 4x loaf tins | 3+1 |  | 170-190* | 30-40 |
| Pizza, homemade, 2 levels | universal pan + baking tray | 3+1 |  | 180-200 | 35-45 |

* Preheat

Tips on baking

| | |
|---|---|
| You want to find out whether the cake is completely cooked in the middle. | Push a cocktail stick into the highest point on the cake. If the cocktail stick comes out clean with no dough residue, the cake is ready. |
| The cake collapses. | Next time, use less liquid. Alternatively, set the temperature to be 10 °C lower and extend the baking time. Adhere to the specified ingredients and preparation instructions in the recipe. |
| The cake has risen in the middle but is lower around the edge. | Only grease the base of the springform cake tin. After baking, loosen the cake carefully with a knife. |
| The fruit juice overflows. | Next time, use the universal pan. |
| Small baked items stick to one another during baking. | There should be a gap of approx. 2 cm around each item. This gives enough space for the baked items to expand well and brown on all sides. |
| The cake is too dry. | Set the temperature 10 °C higher and shorten the baking time. |
| The cake is generally too light in colour. | If the shelf position and the cookware are correct, then you should increase the temperature if necessary or extend the baking time. |
| The cake is too light on top, and too dark underneath. | Bake the cake one level higher in the oven the next time. |
| The cake is too dark on top, and too light underneath. | Bake the cake one level lower in the oven the next time. Select a lower temperature and extend the baking time. |
| Cakes baked in a tray or tin are too brown at the back. | Place the baking tray in the middle of the accessories, not directly against the back wall. |
| The whole cake is too dark. | Select a lower temperature next time and extend the baking time if necessary. |
| The cake is unevenly browned. | Select a slightly lower temperature. Protruding greaseproof paper can affect the air circulation. Always cut greaseproof paper to size. Ensure that the baking tin does not stand directly in front of the openings in the cooking compartment back wall. When baking small items, you should use similar sizes and thicknesses wherever possible. |
| You were baking on several levels. The items on the top baking tray are darker than those on the lower baking tray. | Always use CircoTherm when baking on several levels. Baked items that are placed into the oven on trays or in baking tins/dishes at the same time will not necessarily be ready at the same time. |
| The cake looks good, but is not cooked properly in the middle. | Use a lower temperature and bake slightly longer; if necessary, add slightly less liquid. For cakes with a moist topping, bake the base first. Sprinkle it with almonds or breadcrumbs and then place the topping on top. |
| The cake cannot be turned out of the dish when it is turned upside down. | Allow the cake to cool down for 5 to 10 minutes after baking. If it still sticks, carefully loosen the cake around the edges again using a knife. Turn the cake tin upside down again and cover it several times with a cold, wet cloth. Next time, grease the baking tin/dish and sprinkle with breadcrumbs. |

Roasting and braising

Here, you can find information on roasting and braising poultry and meat. You can find the ideal settings for many dishes in the settings tables.

Poultry

For duck or goose, pierce the skin on the underside of the wings. This allows the fat to run out.

If using duck breast, score the skin. Do not turn duck breasts.

When you turn poultry, ensure that the breast side or the skin side is underneath at first.

Poultry will turn out particularly crispy and brown if you baste it towards the end of the roasting time with butter, salted water or orange juice.

Meat

Baste lean meat with fat as required or cover it with strips of bacon.

Score the rind crosswise. If you turn the joint when cooking, ensure that the rind is underneath at first.

When the joint is ready, turn off the oven and allow it to rest for another 10 minutes in the cooking compartment. This allows the meat juices to be better distributed. Wrap the joint in aluminium foil if necessary. The recommended resting time is not included in the cooking time indicated.

Roasting on the wire rack

On the wire rack, poultry and meat will become very crispy on all sides. Roasting on the wire rack is well suited for larger poultry or for multiple pieces at the same time.

Depending on the size and type of the meat, add up to ½ litres of water to the universal pan. Any dripping fat and meat juices will be caught. You can prepare a sauce using these meat juices. In addition, less smoke is generated, and the cooking compartment stays cleaner.

Slide the universal pan into the oven at the indicated shelf position with the wire rack attached. Ensure that the wire rack is correctly positioned on the universal pan. → "Accessories" on page 9

Roasting and braising in cookware

It is more convenient to roast and braise meat in cookware. You can take the joint out of the cooking compartment more easily in the cookware, and prepare the sauce in the cookware itself.

Only use cookware which is suitable for use in an oven. Check whether the cookware fits in the cooking compartment.

Glass cookware is most suitable. Place hot glass cookware onto a dry mat after cooking. If the surface is damp or cold, the glass may crack.

Add in a little liquid for roasting if the meat is lean. A covering of approx. ½ cm depth should be applied to the base of any glass cookware.

The amount of liquid is dependent on the type of meat, the cookware material and also on whether or not a lid is used. If preparing meat in an enamelled or dark metal roasting dish, it will need a little more liquid than if cooked in glass cookware.

The steam evaporates in the cookware when roasting. Carefully pour in more liquid if required.

Shiny roasting dishes made from stainless steel or aluminium reflect heat like a mirror and are therefore not particularly suitable. The meat cooks more slowly and will not brown so much. Use a higher temperature and/or a longer cooking time.

Observe the manufacturer's instructions for your roasting cookware.

Roasting in uncovered cookware

It is best to use a deep roasting tin/dish for roasting poultry and meat. Place the tin/dish onto the wire rack. If you do not have any suitable cookware, use the universal pan.

Braising in covered cookware

When preparing food with covered cookware, the cooking compartment remains considerably cleaner. Ensure that the lid fits well and closes properly. Place the cookware onto the wire rack.

The distance between the meat and the lid must be at least 3 cm. The meat may rise.

Very hot steam may escape when opening the lid after cooking. Lift the lid at the rear, so that the hot steam can escape away from you.

If necessary, braise the meat first by searing it. Add water, wine, vinegar or a similar liquid to the braising liquid. A covering at least 2 cm deep should be applied to the base of the cookware.

The steam evaporates in the cookware when roasting. Carefully pour in more liquid if required.

Recommended setting values

In the table, you can find the ideal heating type for poultry and meat. Temperature and cooking time depend on the quantity, composition and temperature of the food. Different settings ranges are indicated for this reason. Try using the lower values at first. You can increase the temperature next time if necessary.

The setting values are based on the assumption that unstuffed, chilled, ready-to-roast poultry and meat are placed into a cold cooking compartment. By doing so, you can make energy savings of up to 20 per cent. If you preheat the oven, the indicated cooking times will be reduced by several minutes.

In the table, you can find specifications for poultry and meat with default values for the weight. If you wish to prepare heavier poultry or meat, use the lower temperature in every case. If roasting several joints, use the weight of the heaviest piece as a basis for determining the cooking time. The individual pieces should be approximately equal in size.























A general rule: the larger the poultry or piece of meat is, the lower the cooking temperature and the longer the cooking time.

Turn the poultry and meat after approx. ½ to ⅔ of the indicated time.

Remove unused accessories from the cooking compartment. This will achieve the best possible cooking results and energy savings of up to 20 per cent.

Type of heating used:

-  CircoTherm hot air

| Dish | Accessories/cookware | Shelf position | Type of heating | Temperature in °C | Cooking time in mins. |
|---|-----------------------|----------------|---|-----------------------------------|--|
| Beef | | | | | |
| Slow roast joint | wire rack | 2 |  | 140-150 | 35+40 |
| Top side / Top rump | wire rack | 2 |  | 160-170 | 30+25 |
| Lamb | | | | | |
| Leg (bone-in) | wire rack | 2 |  | 160-170 | 25+25 |
| Shoulder (bone-in) | wire rack | 2 |  | 160-170 | 25+20 |
| Shoulder (boned and rolled) | wire rack | 2 |  | 170-180 | 25+25 |
| Rack of lamb** | wire rack | 2 |  | 180-190* | 15+25 |
| Pork | | | | | |
| Roast joint | wire rack | 2 |  | 180-190 | 30+35 |
| Loin joint | wire rack | 2 |  | 180-190 | 35+35 |
| Belly | wire rack | 2 |  | 170-180 | 30+25 |
| Gammon joint | wire rack | 2 |  | 160-170 | 30+30 |
| Poultry | | | | | |
| Chicken, whole | wire rack | 2 |  | 170-180 | 25+15 |
| Chicken, portion (each 200-250 g)*** | wire rack | 2 |  | 190-200 | 35-45 |
| Duck | wire rack | 2 |  | 180-190 | 25+20 |
| Turkey, crown**** | wire rack | 2 |  | 150-160 | 20+15 |
| Turkey, thighs | wire rack | 2 |  | 170-180 | 25+25 |
| Turkey, whole, 4-8 kg***** | wire rack | 2 |  | 150-160 | 12+12 |
| Meat dishes | | | | | |
| Meat loaf | cookware, uncovered | 2 |  | 170-180 | 20+35 |
| Casserole | | | | | |
| Diced meat (beef, pork, lamb), 500 g meat | cookware, covered | 2 |  | 140* | 100-120 |
| Diced chicken (boned), 500 g meat | cookware, covered | 2 |  | 140* | 90-100 |
| Braising steak | cookware, covered | 2 |  | 140 | 65+60 |
| Complete meal | | | | | |
| With beef | wire rack + wire rack | 4+1 |  | 160, then 200 (Yorkshire Pudding) | calculation for meat (see table above) + 15-25 for Yorkshire Pudding |
| With chicken | wire rack + wire rack | 4+1 |  | 180 | calculation for chicken (see table above) |
| * Preheat | | | | | |
| ** Without fat layer (best and neck), do not turn | | | | | |
| *** Skin side down | | | | | |
| **** Bone side down, do not turn | | | | | |
| ***** Turn after app. 1 hour | | | | | |

Tips on roasting and braising

| | |
|---|--|
| The cooking compartment becomes very dirty. | Prepare your food in an enclosed roasting dish with higher temperature or use the grill tray. You will achieve the best roasting results if you use the grill tray. The grill tray can be bought later as a special accessory. |
| The roast is too dark and the crackling is burned in places, and/or the roast is too dry. | Check the shelf position and temperature. Select a lower temperature the next time and reduce the roasting time if necessary. |
| The crackling is too thin. | Increase the temperature or switch on the grill briefly at the end of the roasting time. |
| The roast looks good but the juices are burnt. | Next time, use a smaller roasting dish and add more liquid if necessary. |
| The roast looks good but the juices are too clear and watery. | Next time, use a larger roasting dish and add less liquid if necessary. |
| The meat gets burned during braising. | The roasting dish and lid must fit together well and close properly. Reduce the temperature and add more liquid when braising if necessary. |

Grilling

Here, you can find information on grilling poultry, meat and fish, as well as toast. You can find the ideal settings for certain dishes in the settings tables.

Grilling with circo-roasting

Circo-roasting is very well suited to the preparation of whole poultry and fish, in addition to meat, e.g. roast pork with crackling.

Poultry

For duck or goose, pierce the skin on the underside of the wings. This allows the fat to run out.

If using duck breast, score the skin. Do not turn duck breasts.

When you turn poultry, ensure that the breast side or the skin side is underneath at first.

Poultry will turn out particularly crispy and brown if you baste it towards the end of the roasting time with butter, salted water or orange juice.

Meat

Baste lean meat with fat as required or cover it with strips of bacon.

Score the rind crosswise. If you turn the joint when cooking, ensure that the rind is underneath at first.

When the joint is ready, turn off the oven and allow it to rest for another 10 minutes in the cooking compartment. This allows the meat juices to be better distributed. Wrap the joint in aluminium foil if necessary. The recommended resting time is not included in the cooking time indicated.

Fish

Fish cooked whole does not have to be turned. Place the whole fish into the cooking compartment in swimming position with the dorsal fin facing upwards. Placing half a potato or a small oven-proof container in the stomach cavity of the fish will provide stability.

You can tell when the fish is cooked because the dorsal fin can be removed easily.

Roasting on the wire rack

On the wire rack, poultry and meat will become very crispy on all sides. Roasting on the wire rack is well suited for larger poultry or for multiple pieces at the same time.

Depending on the size and type of the meat, add up to ½ litres of water to the universal pan. Any dripping fat and meat juices will be caught. You can prepare a sauce using these meat juices. In addition, less smoke is generated, and the cooking compartment stays cleaner.

Slide the universal pan into the oven at the indicated shelf position with the wire rack attached. Ensure that the wire rack is correctly positioned on the universal pan. → "Accessories" on page 9

Roasting in cookware

It is more convenient to roast and braise meat in cookware. You can take the joint out of the cooking compartment more easily in the cookware, and prepare the sauce in the cookware itself.

Only use cookware which is suitable for use in an oven. Check whether the cookware fits in the cooking compartment.

Glass cookware is most suitable. Place hot glass cookware onto a dry mat after cooking. If the surface is damp or cold, the glass may crack.

Add in a little liquid if the meat is lean. A covering of approx. ½ cm depth should be applied to the base of any glass cookware.

The quantity of liquid is dependent on the type of meat, the cookware material and also on whether or not a lid is used. If preparing poultry, meat or fish in an enamelled or dark metal roasting dish, it will need a little more liquid than if cooked in glass cookware.

The steam evaporates in the cookware when roasting. Carefully pour in more liquid if required.

Shiny roasting dishes made from stainless steel or aluminium reflect heat like a mirror and are therefore not particularly suitable. The meat cooks more slowly and will not brown so much. Use a higher temperature and/or a longer cooking time.

Observe the manufacturer's instructions for your roasting cookware.

Uncovered cookware

Use a deep roasting tin/dish for roasting meat. Place the tin/dish onto the wire rack. If you do not have any suitable cookware, use the universal pan.

Covered cookware

When cooking with covered cookware, the cooking compartment remains considerably cleaner. Ensure that the lid fits well and closes properly. Place the cookware onto the wire rack.

The distance between the meat and the lid must be at least 3 cm. The meat may rise.

Very hot steam may escape when opening the lid after cooking. Lift the lid at the rear, so that the hot steam can escape away from you.

If necessary, braise the meat first by searing it. Add water, wine, vinegar or a similar liquid to the braising liquid. A covering approx. 1-2 cm deep should be applied to the base of the cookware.

The steam evaporates in the cookware when roasting. Carefully pour in more liquid if required.

Meat can also become crispy in a covered roasting dish. To do so, use a roasting dish with a glass lid and set a higher temperature.

Grilling flat pieces

Flat pieces of poultry, meat and fish, such as steaks, drumsticks and burgers, can be prepared well using the "Grill" heating type. Excellent results are also achieved when grilling toast.

Grilling

Keep the appliance door closed when using the grill. Never grill with the appliance door open.

Slide the universal pan into the oven at the indicated shelf position with the wire rack attached. Dripping fat will be collected. Ensure that the wire rack is positioned correctly on the universal pan. → "Accessories" on page 9

Note: When grilling very fatty items, do not slide the universal pan in directly under the wire rack, but rather at level 2.

When grilling, try wherever possible to use pieces of food which are of a similar thickness and weight. This will allow them to brown evenly and remain succulent and juicy. Place the food to be grilled directly onto the wire rack.

Use tongs to turn the pieces of food you are grilling. If you pierce the meat with a fork, the juices will run out and it will become dry.

Do not add salt to the meat until after it has been grilled. Salt draws water from the meat.

Notes

- The grill element switches itself on and off continuously; this is normal. The set temperature determines how frequently this occurs.
- Smoke may be produced when grilling.

Recommended setting values

In the table, you can find the ideal heating type for your poultry, meat and fish, in addition to toast. Temperature and cooking time depend on the quantity, composition and temperature of the food. Settings ranges are indicated for this reason. Try using the lower values at first. You can use a higher setting next time if necessary.

The setting values are based on the assumption that unstuffed, chilled, ready-to-roast poultry, meat and fish are placed into a cold cooking compartment.



In the table, you can find specifications for poultry, meat and fish with default values for the weight. If you wish to prepare heavier poultry, meat or fish, use the lower temperature in every case. If roasting several joints, use the weight of the heaviest piece as a basis for determining the cooking time. The individual pieces should be approximately equal in size.



A general rule: the larger the poultry, meat or fish is, the lower the cooking temperature and the longer the cooking time.

Turn the poultry, meat and fish after approx. 1/2 to 2/3 of the indicated time.

Remove unused accessories from the cooking compartment. This will achieve the best possible cooking results and energy savings of up to 20 per cent.

Types of heating used:

-  Circo-roasting
-  Grill, large area

| Dish | Accessories | Shelf position | Type of heating | Temperature in °C | Cooking time in mins. |
|---|-------------|----------------|---|-------------------|--------------------------------|
| Beef | | | | | |
| Steaks, height 2-3 cm** | wire rack | 3 |  | 290 | 1st side 10-12 2nd side 3-5 |
| Burger, height 1-2 cm | wire rack | 3 |  | 290* | 1st side 6-8 2nd side 4-6 |
| Top side / Top rump | wire rack | 2 |  | 150-160 | 30+30 |
| * Preheat | | | | | |
| ** Do not preheat | | | | | |
| *** Preheat 3 minutes | | | | | |
| **** Preheat 3 minutes, turn over several times | | | | | |
| ***** Preheat 5 minutes | | | | | |
| ***** Skin side down | | | | | |

| Dish | Accessories | Shelf position | Type of heating | Temperature in °C | Cooking time in mins. |
|---|-------------|----------------|-----------------|-------------------|----------------------------------|
| Lamb | | | | | |
| Steaks, height 2-3 cm | wire rack | 3 | ☰ | 290* | 1st side 8-10 2nd side 4-6 |
| Chops, height 2-3 cm | wire rack | 3 | ☰ | 290 | 1st side 7-9 2nd side 7-9 |
| Leg (bone-in) | wire rack | 2 | ☏ | 170-180 | 25+30 |
| Shoulder (bone-in) | wire rack | 2 | ☏ | 170-190 | 25+15 |
| Shoulder (boned and rolled) | wire rack | 2 | ☏ | 170-180 | 20+15 |
| Rack of lamb | wire rack | 2 | ☏ | 190-200 | 15+25 |
| Pork | | | | | |
| Steaks, height 2 cm | wire rack | 4 | ☰ | 290 | 1st side 10-12 2nd side 5-7 |
| Chops, height 2-3 cm | wire rack | 3 | ☰ | 275* | 1st side 10-12 2nd side 9-10 |
| Burger, height 1-2 cm*** | wire rack | 3 | ☰ | 290* | 1st side 7-9 2nd side 5-7 |
| Bacon rashers***** | wire rack | 3 | ☰ | 290* | 1st side 4-5 2nd side 3-4 |
| Sausages, thickness 2-4cm**** | wire rack | 3 | ☰ | 290* | 10-15 |
| Roast joint | wire rack | 2 | ☏ | 180-200 | 30+40 |
| Loin joint | wire rack | 2 | ☏ | 180-200 | 35+35 |
| Belly | wire rack | 2 | ☏ | 200-220 | 30+25 |
| Gammon joint | wire rack | 2 | ☏ | 180-200 | 30+25 |
| Poultry | | | | | |
| Chicken drumstick, 150 g each | wire rack | 3 | ☏ | 210-230 | 20-30 |
| Chicken breast, boned, 150 g each*** | wire rack | 3 | ☰ | 275* | 1st side 10-15 2nd side 10-15 |
| Chicken, whole | wire rack | 2 | ☏ | 200-220 | 20+15 |
| Chicken, portion, bone-in, 200-250 g each***** | wire rack | 3 | ☏ | 200-220 | 30-45 |
| Duck, 2-3 kg | wire rack | 2 | ☏ | 190-200 | 20+20 |
| Turkey, thighs | wire rack | 2 | ☏ | 180-190 | 35+20 |
| Turkey, whole, 4-8 kg | wire rack | 2 | ☏ | 140-160 | 12+12 |
| Fish | | | | | |
| Trout, whole, 300 g each | wire rack | 2 | ☏ | 170-190 | 20-30 |
| Fillets, each 150 g*** | wire rack | 4 | ☰ | 220* | 1st side 5-10 2nd side 5-10 |
| Toast | | | | | |
| Grilling white bread** | wire rack | 4 | ☰ | 290 | 4-6 |
| * Preheat | | | | | |
| ** Do not preheat | | | | | |
| *** Preheat 3 minutes | | | | | |
| **** Preheat 3 minutes, turn over several times | | | | | |
| ***** Preheat 5 minutes | | | | | |
| ***** Skin side down | | | | | |

Convenience products

Here, you can find the ideal settings for preparing chilled and frozen food.

Only use original accessories supplied with your appliance. These have been tailored to the cooking compartment and the operating modes of your appliance.

Tips

- The cooking result greatly depends on the quality of the food. Pre-browning and unevenness may already be present on the packaged product.
- Do not use frozen products that are heavily frosted. Remove any ice on the food.
- Distribute foods which are in pieces, such as bread rolls and potato products, so that they are spread flat and evenly on the accessories. Leave a little space between the individual pieces.
- Observe the instructions on the packaging.

Shelf positions

Use the indicated shelf positions.

Baking on one level

When baking on one level, use the following shelf positions:

- Tall baked items: Level 2
- Flat baked items: Level 3

If you are using CircoTherm Hot air as the type of heating, you can choose between levels 1, 2, 3 and 4.

Baking on two levels

Use CircoTherm. Baked items that are placed into the oven on trays or in baking tins/dishes at the same time will not necessarily be ready at the same time.

- Universal pan: Level 3
- Baking tray: Level 1

Accessories

Ensure that you always use suitable accessories and that they are placed in the oven the right way around.

Wire rack

Insert the wire rack with the open side facing the appliance door and the outer rail pointing downwards.

Universal pan or baking tray

Slide the universal pan or the baking tray in carefully as far as the limit stop with the bevelled edge facing the appliance door.

Greaseproof paper

Only use greaseproof paper that is suitable for the selected temperature. Always cut greaseproof paper to size.

Recommended setting values

In the table, you can find the ideal heating type for various dishes. Temperature and cooking time depend on the quantity and composition of the product. Setting ranges are indicated for this reason. Try using the lower values at first. A lower temperature results in more even browning. You can use a higher setting next time if necessary.





Note: Cooking times cannot be reduced by using higher temperatures. The dish would only be cooked on the outside, but would not be fully cooked in the middle.









The setting values apply to dishes placed into a cold cooking compartment. By doing so, you can make energy savings of up to 20 per cent. If you preheat the oven, the indicated cooking times will be reduced by several minutes.

Preheating is necessary for selected dishes, and this is indicated in the table.

Remove unused accessories from the cooking compartment. This will achieve the best possible cooking results and energy savings of up to 20 per cent.

Types of heating used:

-  CircoTherm hot air
-  Top/bottom heating
-  Pizza setting
-  Bread baking setting

| Dish | Accessories/cookware | Shelf position | Type of heating | Temperature in °C | Cooking time in mins. |
|---------------------------------|-----------------------------|----------------|---|-------------------|-----------------------|
| Pizza, chilled | | | | | |
| Pizza, chilled | wire rack | 3 |  | 190-210 | 10-15 |
| Pizza, frozen | | | | | |
| Pizza, thin base | wire rack | 3 |  | 190-210 | 15-20 |
| Pizza, thin base, 2 levels | universal pan + wire rack | 3+1 |  | 190-210 | 20-25 |
| Pizza, thick base | wire rack | 3 |  | 180-200 | 20-25 |
| Pizza, thick base, 2 levels | universal pan + wire rack | 3+1 |  | 190-210 | 20-30 |
| Pizza baguette | wire rack | 3 |  | 200-220 | 15-20 |
| Potatoe products, frozen | | | | | |
| Oven chips | universal pan | 3 |  | 190-210 | 25-35 |
| Oven chips, 2 levels | universal pan + baking tray | 3+1 |  | 190-210 | 30-40 |
| Croquettes | universal pan | 3 |  | 200-220 | 25-35 |

* Turn during cooking

| Dish | Accessories/cookware | Shelf position | Type of heating | Temperature in °C | Cooking time in mins. |
|--------------------------------------|-----------------------------|----------------|-----------------|-------------------|-----------------------|
| Hash browns | universal pan | 3 | | 200-220 | 25-35 |
| Potatoe wedges | universal pan | 3 | | 190-210 | 25-35 |
| Baked goods, frozen, prebaked | | | | | |
| Rolls, baguettes | universal pan | 3 | | 180-200 | 10-15 |
| Fried food, frozen | | | | | |
| Fish fingers* | universal pan | 3 | | 200-220 | 20-30 |
| Chicken nuggets | universal pan | 3 | | 190-210 | 20-25 |
| Food, chilled | | | | | |
| Lasagna, 500 g | ovenproof dish on wire rack | 2 | | 190-210 | 30-35 |
| Lasagna, 1,5 kg | ovenproof dish on wire rack | 2 | | 180-200 | 30-40 |
| Food, frozen | | | | | |
| Lasagna, 500 g | ovenproof dish on wire rack | 2 | | 190-210 | 30-35 |
| Lasagna, 1,5 kg | ovenproof dish on wire rack | 2 | | 180-200 | 50-70 |
| * Turn during cooking | | | | | |

Yogurt

You can make your own yogurt using your appliance.

Preparing yogurt

Remove accessories and shelves from the cooking compartment. The cooking compartment must be empty.

- Heat 1 litre of milk (3.5 % fat) to 90 °C on the hob and then cool down to 40 °C.
It is sufficient to heat UHT milk to 40 °C.

- Stir in 150 g (chilled) yogurt.
- Pour into cups or small jars and cover with cling film.
- Place the cups or jars onto the cooking compartment floor and use the settings indicated in the table.
- After preparation, leave the yogurt to cool in the refrigerator.

Type of heating used:

- Dough proving

| Dish | Cookware | Shelf position | Type of heating | Temperature in °C | Cooking time in hours |
|---------|-------------------|---------------------------|-----------------|-------------------|-----------------------|
| Yoghurt | individual moulds | cooking compartment floor | | 35-40 | 8-9h |

Save energy with Eco heating types

You can save energy when cooking using the energy-efficient heating types "CircoTherm Eco" and "Top/bottom heating Eco".

Place the food into the empty cooking compartment before it has heated up. Otherwise, energy optimisation will not have any effect. Always keep the appliance door closed when cooking.

Remove unused accessories from the cooking compartment. This will allow you to achieve ideal cooking results and save energy.

Only use original accessories supplied with your appliance. These have been tailored to the cooking compartment and the operating modes of your appliance.

Accessories

Ensure that you always use suitable accessories and that they are placed in the oven the right way around.

Wire rack

Insert the wire rack with the open side facing the appliance door and the outer rail pointing downwards .

Universal pan or baking tray

Slide the universal pan or the baking tray in carefully as far as the limit stop with the bevelled edge facing the appliance door.

Baking tins and cookware

Dark- coloured metal baking tins are most suitable. These allow you to make energy savings of up to 35 per cent.

Cookware made from stainless steel or aluminium reflects heat like a mirror. Non-reflective cookware made from enamel, heat-resistant glass or coated, die-cast aluminium is more suitable.

Tinplate baking tins, ceramic dishes or glass dishes prolong baking time, and the cake will not brown so evenly.

Greaseproof paper



Only use greaseproof paper that is suitable for the selected temperature. Always cut greaseproof paper to size.





















Recommended setting values

Here, you can find specifications for the various dishes with CircoTherm Eco and Top/bottom heating Eco. The temperature and baking time depend on the consistency and amount of the dough. Settings ranges are indicated for this reason. Try with the lower values first. A lower temperature results in more even browning. You can increase the temperature next time if necessary.

Note: Baking times can not be reduced by using higher temperatures. Cakes or baked items would only be cooked on the outside, but would not be fully cooked in the middle.

Types of heating used:

-  CircoTherm Eco
-  Top/bottom heating Eco

| Dish | Accessories/cookware | Shelf position | Type of heating | Temperature in °C | Cooking time in mins. |
|---|---------------------------------|----------------|---|-------------------|-----------------------|
| Baking | | | | | |
| Victoria Sponge Cake | 2x Ø20 cm tins | 2 |  | 170-180 | 30-40 |
| Light Fruit Cake | high Ø20 cm tin | 2 |  | 150-170 | 70-90 |
| Rich Fruit Cake | high Ø23 cm tin | 2 |  | 140-160 | 120-180 |
| Fruit crumble | flat glass dish | 3 |  | 160-180 | 40-70 |
| Sponge Cake (fatless), 3 eggs | springform cake tin Ø26 cm | 2 |  | 160-170 | 25-40 |
| Swiss Roll | swiss roll tin | 3 |  | 180-190 | 15-25 |
| Fruit Pie | plate Ø20 cm or pie tin | 2 |  | 170-190 | 60-75 |
| Quiche | quiche tin (dark coated) | 3 |  | 190-210 | 35-45 |
| (White) Bread | loaf tin (1x 900 g or 2x 450 g) | 2 |  | 190-200 | 40-50 |
| Scones | baking tray | 3 |  | 190-210 | 15-20 |
| Jam tarts | 12-cup-tin | 3 |  | 180-200 | 20-30 |
| Soufflé | 1,2L-soufflé dish | 2 |  | 160-170 | 40-50 |
| Meat Pie | rectangular pie tin | 2 |  | 190-200 | 40-55 |
| Jacket Potatoes | baking tray | 3 |  | 150-170 | 60-90 |
| Meat | | | | | |
| Beef, slow roast joint | wire rack | 2 |  | 140-150 | 35+40 |
| Casserole | | | | | |
| Diced meat (beef, pork, lamb), 500 g meat | cookware, covered | 2 |  | 140 | 100-120 |
| Braising steak | cookware, covered | 2 |  | 140 | 65+60 |
| Fish | | | | | |
| Fish, braised, whole 300 g, e. g. trout | cookware, covered | 2 |  | 190-210 | 25-35 |
| Fish, braised, whole 1,5kg, e. g. salmon | cookware, covered | 2 |  | 190-210 | 45-55 |
| Fish fillet, plain, braised, 100 g | cookware, covered | 2 |  | 190-210 | 15-25 |

Acrylamide in foodstuffs

Acrylamide is mainly produced in grain and potato products prepared at high temperatures, such as potato crisps, chips, sliced bread, bread rolls, bread or fine baked goods (biscuits, gingerbread, spiced biscuit).

| Tips for keeping acrylamide to a minimum | |
|--|---|
| General | <ul style="list-style-type: none"> ■ Keep cooking times as short as possible. ■ Cook food until it is golden brown, but not too dark. ■ Large, thick pieces of food contain less acrylamide. |
| Baking | With top/bottom heating at max. 200 °C. With hot air at max. 180 °C. |
| Biscuits | With top/bottom heating at max. 190 °C. With hot air at max. 170 °C. Egg or egg yolk reduces the production of acrylamide. |
| Oven chips | Spread out a single layer evenly on the baking tray. Cook at least 400 g at once on a baking tray so that the chips do not dry out. |

Slow cook

Slow cooking is a technique for cooking food over a long period at low temperatures. For this reason, it is also called "low-temperature cooking".

Slow cooking is ideal for all prime cuts (e.g. tender portions of beef, veal, pork, lamb or poultry) which are to be cooked "à point". The meat will remain succulent and tender.

The benefit of this cooking method is that it allows lots of scope for menu planning because slow-cooked meat is easy to keep warm. You do not have to turn the meat when cooking. Keep the appliance door closed in order to maintain an even cooking climate.

Only use fresh, clean and hygienic meat without bones. Carefully remove sinews and fat from around the edge. Fat develops a strong, distinct flavour during slow cooking. You can also use seasoned or marinated meat. Do not use defrosted meat.

Meat can be carved immediately following slow cooking. No standing time is required. Due to the special cooking method, the meat looks pink, but is not raw or undercooked.

Note: Delayed-start operation with an end time is not possible for the slow cooking heating type.

Cookware

Use shallow cookware, e.g. a glass/porcelain serving dish. Place the cookware into the cooking compartment to preheat it.

Always place the uncovered cookware onto the wire rack at level 2.

You can find additional information in the tips on slow cooking attached to the settings table.

Your appliance features the heating type "Slow cook". Only start operation when the cooking compartment has fully cooled down. Allow the cooking compartment to warm up for approx. 15 minutes with the cookware inside.

















Sear the meat on the hotplate at a very high heat and for a sufficiently long time on all sides, even on the ends. Place into the preheated cookware right away. Place the cookware containing the meat into the cooking compartment once again and cook slowly.

Recommended setting values

The slow cooking temperature and cooking time are dependent on the size, thickness and quality of the meat. Different settings ranges are indicated for this reason.

Type of heating used:

-  Slow cooking

| Dish | Cookware | Shelf position | Type of heating | Searing time in mins. | Temperature in °C | Cooking time in mins. |
|---|---------------------|----------------|--|-----------------------|-------------------|-----------------------|
| Poultry | | | | | | |
| Duck breast, 400 g | Cookware, uncovered | 2 |  | 6-8 | 90* | 45-60 |
| Chicken breast fillet, 200 g each | Cookware, uncovered | 2 |  | 5-7 | 90* | 30-60 |
| Turkey breast, boned, 1 kg | Cookware, uncovered | 2 |  | 8-10 | 90* | 150-210 |
| Pork | | | | | | |
| Pork tenderloin steak, 5-6 cm thick, 1.5 kg | Cookware, uncovered | 2 |  | 8-10 | 80* | 210-240 |
| Pork fillet, whole | Cookware, uncovered | 2 |  | 6-8 | 80* | 90-120 |
| Pork medallions, 4 cm thick | Cookware, uncovered | 2 |  | 5-7 | 80* | 90-120 |
| Beef | | | | | | |
| Joint of beef (rump), 6-7 cm thick, 1.5 kg | Cookware, uncovered | 2 |  | 8-10 | 80* | 210-270 |
| Beef tenderloin, whole, 1 kg | Cookware, uncovered | 2 |  | 4-6 | 80* | 150-210 |
| Sirloin, 5-6 cm thick | Cookware, uncovered | 2 |  | 6-8 | 80* | 210-270 |
| Beef medallions/rump steak, 4 cm thick | Cookware, uncovered | 2 |  | 5-7 | 80* | 30-60 |
| Veal | | | | | | |
| Joint of veal, 4-5 cm thick, 1.5 kg | Cookware, uncovered | 2 |  | 8-10 | 80* | 210-240 |
| Joint of veal, 10-15 cm thick, 1.5 kg | Cookware, uncovered | 2 |  | 8-10 | 80* | 210-240 |
| Veal fillet, whole, 800 g | Cookware, uncovered | 2 |  | 5-7 | 80* | 120-150 |
| Veal medallions, 4 cm thick | Cookware, uncovered | 2 |  | 5-7 | 80* | 45-90 |
| Lamb | | | | | | |
| Saddles of lamb, boneless, 200 g each | Cookware, uncovered | 2 |  | 5-7 | 80* | 120-180 |
| Leg of lamb, boned, medium, 1 kg, tied | Cookware, uncovered | 2 |  | 6-8 | 80* | 180-240 |
| * Preheat | | | | | | |

Tips for slow cooking

| | |
|--|---|
| Slow-cooking duck breast. | Place the cold duck breast into a pan and fry the skin side first. After slow cooking, grill for 3 to 5 minutes until crispy. |
| The slow-cooked meat is not as hot as conventionally roasted meat. | So that the roasted meat does not cool so quickly, warm the plates and serve the sauces very hot. |

Drying

You can achieve outstanding drying results with CircoTherm. With this type of preserving, flavourings are concentrated by the dehydration.

Only use unblemished fruit, vegetables and herbs and wash them thoroughly. Line the wire rack with greaseproof paper or parchment paper. Drain the excess water from the fruit and dry it.

If necessary, cut it into equal chunks or thin slices. Place unpeeled fruit onto the dish with the sliced surfaces facing upwards. Ensure that neither fruit nor mushrooms overlap on the wire rack.

Grate vegetables and then blanch them. Allow the blanched vegetables to drain off and distribute them evenly on the wire rack.

Dry herbs on the stem. Position the herbs evenly and slightly heaped on the wire rack.

Use the following shelf positions for drying:

- 1 wire rack: Level 3
- 2 wire racks: Level 3+1

Turn very juicy fruit and vegetables several times. After drying, remove the dried products from the paper immediately.





Recommended setting values

In the table, you can find settings for drying various foodstuffs. The temperature and cooking time are dependent on the type, moisture, ripeness and thickness of the food to be dried. The longer you leave the food to be dried, the better it will be preserved. The thinner the slices are, the quicker the drying process will be and the more aromatic the dried food will remain. Setting ranges are indicated for this reason.

If you wish to dry additional foodstuffs, you should use similar foodstuffs in the table as a reference.

Type of heating used:

-  CircoTherm hot air

| Fruit, vegetables and herbs | Accessories | Type of heating | Temperature in °C | Cooking time in hours |
|--|----------------|---|-------------------|-----------------------|
| Pomes (apple rings, 3 mm thick, 200 g per wire rack) | 1-2 wire racks |  | 80 | 5-9 |
| Stone fruit (plums) | 1-2 wire racks |  | 80 | 8-10 |
| Root vegetables (carrots), grated, blanched | 1-2 wire racks |  | 80 | 5-8 |
| Sliced mushrooms | 1-2 wire racks |  | 60 | 6-9 |
| Herbs, washed | 1-2 wire racks |  | 60 | 2-6 |

Preserving

You can preserve fruit and vegetables using your appliance.

Warning **Risk of injury!**

If the food is preserved incorrectly, the preserving jars may burst. Follow the instructions for preserving.

Jars

Use only clean and undamaged preserving jars. Only use heat-resistant, clean and undamaged rubber rings. Check clips and clamps in advance.

For each preserving process, only use preserving jars that are the same size and contain the same food. In the cooking compartment, you can preserve the contents of a maximum of six ½, 1 or 1½-litre preserving jars at the same time. Do not use jars that are larger or taller than this. The lids could rupture.

Preserving jars must not touch one another in the cooking compartment during the preserving process.

Preparing fruit and vegetables

Only use fruit and vegetables that are in good condition. Wash them thoroughly.

Peel, core and chop fruit and vegetables appropriate to their type and fill the preserving jars with them up to approx. 2 cm below the rim.

Fruit

Fill the preserving jars with the fruit along with a hot, skimmed sugar solution (approx. 400 ml for a 1-litre jar). For one litre of water:

- Approx. 250 g sugar for sweet fruit
- Approx. 500 g sugar for sour fruit

Vegetables

Fill the jars with the vegetables along with hot, boiled water.

Wipe the rims of the jars, as they must be clean. Place a damp rubber ring and a lid on each jar. Seal the jars with clamps. Place the jars into the universal pan so that they do not touch each other. Pour 500 ml hot water (approx. 80 °C) into the universal pan. Use the settings indicated in the table.

Ending the preserving process

Fruit

After a short while, small bubbles will form at short intervals. Switch off the appliance once all preserving jars are bubbling. Remove the jars from the cooking compartment after the indicated cooling time.

Vegetables

After a short while, small bubbles will form at short intervals. As soon as all preserving jars are bubbling, reduce the temperature to 120 °C and allow the jars to continue to bubble in the closed cooking compartment as indicated in the table. After this time has elapsed, switch off the appliance and make use of the residual heat for several minutes as indicated in the table.





After preserving, remove the jars from the cooking compartment and place them onto a clean cloth. Do not place these hot jars onto a cold or damp surface, as they may crack. Cover the preserving jars to protect them from draughts. Only remove the clamps once the jars are cold.

Recommended setting values

The indicated times in the settings table are average values for preserving fruit and vegetables. They may be influenced by room temperature, the number of jars, quantity, heat and quality of the jar contents. The specifications are based on 1-litre round jars. Before you switch off the appliance or change the cooking mode, check whether the contents of the jars are bubbling as they should. The bubbling process starts after approx. 30-60 minutes.

Type of heating used:

-  CircoTherm hot air

| Preserving | Cookware | Shelf position | Type of heating | Temperature in °C | Cooking time in mins. |
|-------------------------------------|-------------------------|----------------|---|-------------------|----------------------------------|
| Vegetables, e.g. carrots | 1-litre preserving jars | 1 |  | 160-170 | Before it starts bubbling:30-40 |
| | | | | 120 | When it starts to bubble: 30-40 |
| | | | | - | Residual heat: 30 |
| Vegetables, e.g. cucumbers | 1-litre preserving jars | 1 |  | 160-170 | Before it starts bubbling: 30-40 |
| | | | | - | Residual heat: 30 |
| Stone fruit, e.g. cherries, damsons | 1-litre preserving jars | 1 |  | 160-170 | Before it starts bubbling:30-40 |
| | | | | - | Residual heat:35 |
| Pomes, e.g. apples, strawberries | 1-litre preserving jars | 1 |  | 160-170 | Before it starts bubbling:30-40 |
| | | | | - | Residual heat: 25 |

Allowing the dough to prove at dough proving setting

Yeast dough will prove considerably more quickly using the "Dough proving" heating type than at room temperature and does not dry out. Only start operation when the cooking compartment has fully cooled down.

Always allow yeast dough to prove twice. Observe the specifications in the settings tables for the 1st and 2nd proving processes (dough fermentation and final fermentation).

Dough fermentation

Pour 200 ml water onto the cooking compartment floor for the dough fermentation.

Caution!

Surface damage

- Never pour water into the hot cooking compartment. The temperature change can cause damage to the enamel.
- Do not use distilled water. Use tap water only.

Place the dough into a heat-resistant bowl and place it onto the wire rack. Use the settings indicated in the table.

Do not open the appliance door during the proving process, as moisture will escape. Do not cover the dough.

Condensation builds during operation which steams up the door pane. Wipe out the cooking compartment after dough proving. Loosen any limescale with a little vinegar and wipe with clean water.

Final fermentation

Place your baked item into the oven at the shelf position indicated in the table.

If you want to preheat the oven, the final fermentation takes place outside the appliance in a warm place.

Recommended setting values

The temperature and proving time are dependent on the type and quantity of the ingredients. The values in the table are therefore only meant to be average values.

Type of heating used:

- ☰ Dough proving

| Dish | Accessories/cookware | Shelf position | Type of heating | Step | Temperature in °C | Cooking time in mins. |
|-----------------------------|----------------------|----------------|-----------------|--------------------|-------------------|-----------------------|
| Yeast dough, light | Bowl | 2 | ☰ | Dough fermentation | 35-40 | 25-30 |
| | Baking tray | 2 | ☰ | Final fermentation | 35-40 | 10-20 |
| Yeast dough, heavy and rich | Bowl | 2 | ☰ | Dough fermentation | 35-40 | 20-40 |
| | Baking tray | 2 | ☰ | Final fermentation | 35-40 | 15-25 |

Defrosting

Use heating type "CircoTherm" to defrost frozen fruit, vegetables and baked items. Poultry, meat and fish should ideally be defrosted in the refrigerator.

Use the following shelf positions when defrosting:

- 1 wire rack: Level 2
- 2 wire racks: Level 3+1

Recommended setting values

The times in the table are average values. They are dependent on the quality, freezing temperature (-18 °C) and composition of the food. Time ranges are indicated. Set the shortest time first and then extend the time if necessary.

Tip: Items which were frozen flat or portioned defrost faster than those frozen in a block.

Remove frozen food from the packaging and place it in suitable cookware onto the wire rack.

Stir the food or turn it once or twice in between. Large pieces of food should be turned several times. Occasionally split the food or remove items which have already defrosted from the cooking compartment.

Leave the defrosted food to rest for another 10 to 30 minutes in the appliance whilst it is switched off, so that the temperature balances out.

Type of heating used:

- ☼ CircoTherm hot air

| Dish | Accessories | Shelf position | Type of heating | Temperature in °C | Cooking time in mins. |
|-----------------------------|-------------|----------------|-----------------|-------------------|-----------------------|
| Bread, bread rolls | | | | | |
| Bread & bread rolls general | Baking tray | 2 | ☼ | 50 | 40-70 |
| Cake | | | | | |
| Cake, moist | Baking tray | 2 | ☼ | 50 | 70-90 |
| Cake, dry | Baking tray | 2 | ☼ | 60 | 60-75 |

Keeping warm

You can keep cooked dishes warm using the top/bottom heating type at 70 °C. This will avoid condensation developing, and means you will not have to wipe out the cooking compartment.

Do not keep cooked dishes warm for longer than two hours. Be aware that some dishes may continue cooking whilst being kept warm. Cover the dishes if necessary.

Test dishes

These tables have been produced for test institutes to facilitate the inspection of the appliance.

In accordance with EN 60350-1:2013 and IEC 60350-1:2011.

Baking

Baked items that are placed into the oven on trays or in baking tins/dishes at the same time will not necessarily be ready at the same time.

Shelf positions for baking on two levels:

- Universal pan: Level 3
Baking tray: Level 1
- Baking tins/dishes on the wire rack
First wire rack: Level 3
Second wire rack: Level 1

Shelf positions for baking on three levels:

- Baking tray: Level 4
- Universal pan: Level 3
- Baking tray: Level 1

Double-crust apple pie

Double-crust apple pie on one level: place dark-coloured springform cake tins diagonally next to each other.

Double-crust apple pie on two levels: position dark-coloured springform cake tins above each other so that they are offset.

Cakes in tinplate springform cake tins: bake on one level with top/bottom heating. Place the springform cake tin onto the universal pan instead of onto the wire rack.



Hot water sponge cake















Hot water sponge cake on two levels: vertically stack springform cake tins in an offset manner on the wire racks.

Notes

- The setting values apply to dishes placed into a cold cooking compartment.
- Please note the information in the tables about preheating. The setting values are valid without rapid heating-up.
- For baking, use the lower of the indicated temperatures first.

Types of heating used:

-  CircoTherm hot air
-  Top/bottom heating
-  Pizza setting



| Dish | Accessory | Shelf position | Type of heating | Temperature in °C | Cooking time in mins. |
|---|--------------------------------------|----------------|---|-------------------|-----------------------|
| Baking | | | | | |
| Whirls*** | Baking tray | 3 |  | 140-150* | 25-40 |
| Whirls*** | Baking tray | 3 |  | 140-150* | 25-40 |
| Whirls, 2 levels*** | Universal pan + baking tray | 3+1 |  | 140-150* | 30-40 |
| Whirls, 3 levels*** | Baking trays + universal pan | 4+3+1 |  | 130-140* | 35-55 |
| Small cakes*** | Baking tray | 3 |  | 160* | 20-30 |
| Small cakes*** | Baking tray | 3 |  | 150* | 25-35 |
| Small cakes, 2 levels*** | Universal pan + baking tray | 3+1 |  | 150* | 25-35 |
| Small cakes, 3 levels*** | Baking trays + universal pan | 4+3+1 |  | 140* | 35-45 |
| Hot water sponge cake** | Springform cake tin, diameter 26 cm | 2 |  | 160-170* | 25-35 |
| Hot water sponge cake** | Springform cake tin, diameter 26 cm | 2 |  | 160-170* | 30-40 |
| Hot water sponge cake, 2 levels** | Springform cake tin, diameter 26 cm | 3+1 |  | 150-170* | 30-50 |
| Double-crust apple pie | 2 x black plate tins, diameter 20 cm | 2 |  | 170-180 | 60-80 |
| Double-crust apple pie | 2 x black plate tins, diameter 20 cm | 2 |  | 180-200 | 60-80 |
| Double-crust apple pie, 2 levels | 2 x black plate tins, diameter 20 cm | 3+1 |  | 170-190 | 70-90 |
| * Preheat | | | | | |
| ** Preheat, do not use quick heat function | | | | | |
| *** Preheat for 5 mins., do not use quick heat function | | | | | |

Grilling

Also slide in the universal pan. The liquid will be caught and the cooking compartment stays cleaner.

Type of heating used:

-  Grill, large area

| Dish | Accessories | Shelf position | Type of heating | Temperature in °C | Cooking time in mins. |
|-------------------------------------|-------------|----------------|---|-------------------|-----------------------|
| Grilling | | | | | |
| Toasting bread* | Wire rack | 4 |  | 290 | 4-6 |
| Beefburgers, x 12** | Wire rack | 4 |  | 290 | 25-30 |
| * Do not preheat | | | | | |
| ** Turn after 2/3 of the total time | | | | | |



A series of 22 horizontal lines spaced evenly down the page, serving as a writing template.



Constructa Neff
Vertriebs-GmbH
Carl-Wery-Straße 34
D-81739 München

Register your product online

www.neff-international.com



9001082122

950622