



Built-in oven

[en] Instruction manual

U15E52.5AU





# en Table of contents

<b>Important safety information</b> .....	<b>4</b>	<b>Defrost</b> .....	<b>24</b>
Causes of damage .....	5	Defrosting with CircoTherm®.....	24
<b>Energy and environment tips</b> .....	<b>5</b>	Defrost.....	24
Saving energy.....	5	<b>Yoghurt</b> .....	<b>24</b>
Environmentally-friendly disposal.....	5	<b>Cleaning and care</b> .....	<b>24</b>
<b>Your new appliance</b> .....	<b>6</b>	Cleaning the appliance exterior .....	25
Control panel .....	6	Cleaning the cooking compartment.....	25
Operating modes.....	7	Self-cleaning surfaces.....	26
<b>Your accessories</b> .....	<b>8</b>	Oven cleaning.....	26
Accessories .....	8	Removing and fitting the appliance door.....	26
Inserting accessories .....	8	Cleaning the door panels.....	27
Shelf positions .....	8	Cleaning the hook-in racks .....	27
Optional accessories .....	9	<b>Faults and repairs</b> .....	<b>28</b>
<b>Before using the appliance for the first time</b> .....	<b>9</b>	Replacing the oven light bulb.....	29
Setting the clock .....	9	Changing the door seal.....	29
Cleaning the appliance.....	9	<b>After-sales service</b> .....	<b>29</b>
<b>Operating the appliance</b> .....	<b>9</b>	E number and FD number .....	29
Switching on the appliance.....	9	<b>Test dishes</b> .....	<b>30</b>
Switching off the appliance.....	10		
Changing the basic settings.....	10		
Automatic safety cut-out.....	10		
<b>Electronic clock</b> .....	<b>11</b>		
Clock display .....	11		
Timer .....	11		
Cooking time .....	11		
End of operation .....	12		
Preset operation.....	12		
Setting the clock .....	12		
Rapid heat up.....	12		
Checking, correcting or deleting settings .....	13		
<b>Childproof lock</b> .....	<b>13</b>		
Lock.....	13		
Permanent lock .....	13		
<b>Baking</b> .....	<b>14</b>		
Baking on one level.....	14		
Baking on two or more levels .....	14		
Baking table.....	14		
Baking table for ready-made products .....	16		
Tips and tricks.....	16		
<b>Roasting and braising</b> .....	<b>17</b>		
Roasting.....	17		
Braising.....	17		
Tables for roasting and braising .....	18		
Tips and tricks .....	19		
<b>Grilling</b> .....	<b>20</b>		
Circo-roasting .....	20		
Radiant grilling.....	20		
Grilling table.....	20		
<b>CircoTherm® eco</b> .....	<b>22</b>		
<b>Low-temperature cooking</b> .....	<b>23</b>		
Using Low-temperature cooking .....	23		
Table for Low-temperature cooking .....	23		
Tips and tricks .....	23		

---

Additional information on products, accessories, replacement parts and services can be found at [www.neff-international.com](http://www.neff-international.com) and in the online shop [www.neff-eshop.com](http://www.neff-eshop.com)

## Important safety information

Read these instructions carefully. Only then will you be able to operate your appliance safely and correctly. Retain the instruction manual and installation instructions for future use or for subsequent owners.

This appliance is only intended to be fully fitted in a kitchen. Observe the special installation instructions.

Check the appliance for damage after unpacking it. Do not connect the appliance if it has been damaged in transport.

Only a licensed professional may connect appliances without plugs. Damage caused by incorrect connection is not covered under warranty.

This appliance is intended for domestic use only. The appliance must only be used for the preparation of food and drink. The appliance must be supervised during operation. Only use this appliance indoors.

This appliance is intended for use up to a maximum height of 2000 metres above sea level.

This appliance may be used by children over the age of 8 years old and by persons with reduced physical, sensory or mental capabilities or by persons with a lack of experience or knowledge if they are supervised or are instructed by a person responsible for their safety how to use the appliance safely and have understood the associated hazards.

Children must not play with, on, or around the appliance. Children must not clean the appliance or carry out general maintenance unless they are at least 8 years old and are being supervised.

Keep children below the age of 8 years old at a safe distance from the appliance and power cable.

Always slide accessories into the cooking compartment correctly. See "*Description of accessories*" in the instruction manual.

### **Risk of fire!**

- Combustible items stored in the cooking compartment may catch fire. Never store combustible items in the cooking compartment. Never open the appliance door if there is smoke inside. Switch off the appliance and unplug it from the

mains or switch off the circuit breaker in the fuse box.

- A draught is created when the appliance door is opened. Greaseproof paper may come into contact with the heating element and catch fire. Do not place greaseproof paper loosely over accessories during preheating. Always weight down the greaseproof paper with a dish or a baking tin. Only cover the surface required with greaseproof paper. Greaseproof paper must not protrude over the accessories.

### **Risk of burns!**

- The appliance becomes very hot. Never touch the interior surfaces of the cooking compartment or the heating elements. Always allow the appliance to cool down. Keep children at a safe distance.
- Accessories and ovenware become very hot. Always use oven gloves to remove accessories or ovenware from the cooking compartment.
- Alcoholic vapours may catch fire in the hot cooking compartment. Never prepare food containing large quantities of drinks with a high alcohol content. Only use small quantities of drinks with a high alcohol content. Open the appliance door with care.

### **Risk of scalding!**

- The accessible parts become hot during operation. Never touch the hot parts. Keep children at a safe distance.
- When you open the appliance door, hot steam may escape. Open the appliance door with care. Keep children at a safe distance.
- Water in a hot cooking compartment may create hot steam. Never pour water into the hot cooking compartment.

### **Risk of injury!**

Scratched glass in the appliance door may develop into a crack. Do not use a glass scraper, sharp or abrasive cleaning aids or detergents.

## Risk of electric shock!

- Incorrect repairs are dangerous. Repairs may only be carried out by one of our trained after-sales engineers. If the appliance is faulty, unplug the mains plug or switch off the fuse in the fuse box. Contact the after-sales service.
- The cable insulation on electrical appliances may melt when touching hot parts of the appliance. Never bring electrical appliance cables into contact with hot parts of the appliance.
- Do not use any high-pressure cleaners or steam cleaners, which can result in an electric shock.
- When replacing the cooking compartment bulb, the bulb socket contacts are live. Before replacing the bulb, unplug the appliance from the mains or switch off the circuit breaker in the fuse box.
- A defective appliance may cause electric shock. Never switch on a defective appliance. Unplug the appliance from the mains or switch off the circuit breaker in the fuse box. Contact the after-sales service.

## Risk of burns!

The appliance will become very hot on the outside during the cleaning function. Never touch the appliance door. Allow the appliance to cool down. Keep children at a safe distance.

## Causes of damage

### Caution!

- Accessories, foil, greaseproof paper or ovenware on the cooking compartment floor: do not place accessories on the cooking compartment floor. Do not cover the cooking compartment floor with any sort of foil or greaseproof paper. Do not place ovenware on the cooking compartment floor if a temperature of over 50 °C has been set. This will cause heat to accumulate. The baking and roasting times will no longer be correct and the enamel will be damaged.
- Water in a hot cooking compartment: do not pour water into the cooking compartment when it is hot. This will cause steam. The temperature change can cause damage to the enamel.
- Moist food: do not store moist food in the cooking compartment when it is closed for prolonged periods This will damage the enamel.
- Fruit juice: when baking particularly juicy fruit pies, do not pack the baking tray too generously. Fruit juice dripping from the baking tray leaves stains that cannot be removed. If possible, use the deeper universal pan.
- Cooling with the appliance door open: only allow the cooking compartment to cool when it is closed. Even if the appliance door is only open a little, front panels of adjacent units could be damaged over time.
- Very dirty door seal: If the door seal is very dirty, the appliance door will no longer close properly when the appliance is in use. The fronts of adjacent units could be damaged. Always keep the door seal clean.
- Appliance door as a seat, shelf or worktop: Do not sit on the appliance door, or place or hang anything on it. Do not place any cookware or accessories on the appliance door.
- Inserting accessories: depending on the appliance model, accessories can scratch the door panel when closing the appliance door. Always insert the accessories into the cooking compartment as far as they will go.
- Carrying the appliance: do not carry or hold the appliance by the door handle. The door handle cannot support the weight of the appliance and could break.

---

## Energy and environment tips

Here you can find tips on how to save energy when baking and roasting and how to dispose of your appliance properly.

**Note:** For this appliance, an energy consumption value has been established that meets DIN EN 50304/DIN EN 60350. This energy consumption value is 30% below that for energy efficiency class A.

Depending on the appliance equipment, the additional NeffLight® lighting was switched off while measuring (see section: Switching off NeffLight®).

### Saving energy

Only preheat the oven if this is specified in the recipe or in the operating instruction tables.

Use dark, black lacquered or enamelled baking tins. They absorb the heat particularly well.

Open the appliance door as little as possible during cooking, baking or roasting.

It is best to bake several cakes one after the other. The cooking compartment is still warm. This may reduce the baking time for the second cake.

For longer cooking times, you can switch the oven off 10 minutes before the end of the cooking time and use the residual heat to finish cooking.

### Environmentally-friendly disposal

Dispose of packaging in an environmentally-friendly manner.



This appliance is labelled in accordance with European Directive 2012/19/EU concerning used electrical and electronic appliances (waste electrical and electronic equipment - WEEE). The guideline determines the framework for the return and recycling of used appliances as applicable throughout the EU.





# Your new appliance

In this section, you will find information on

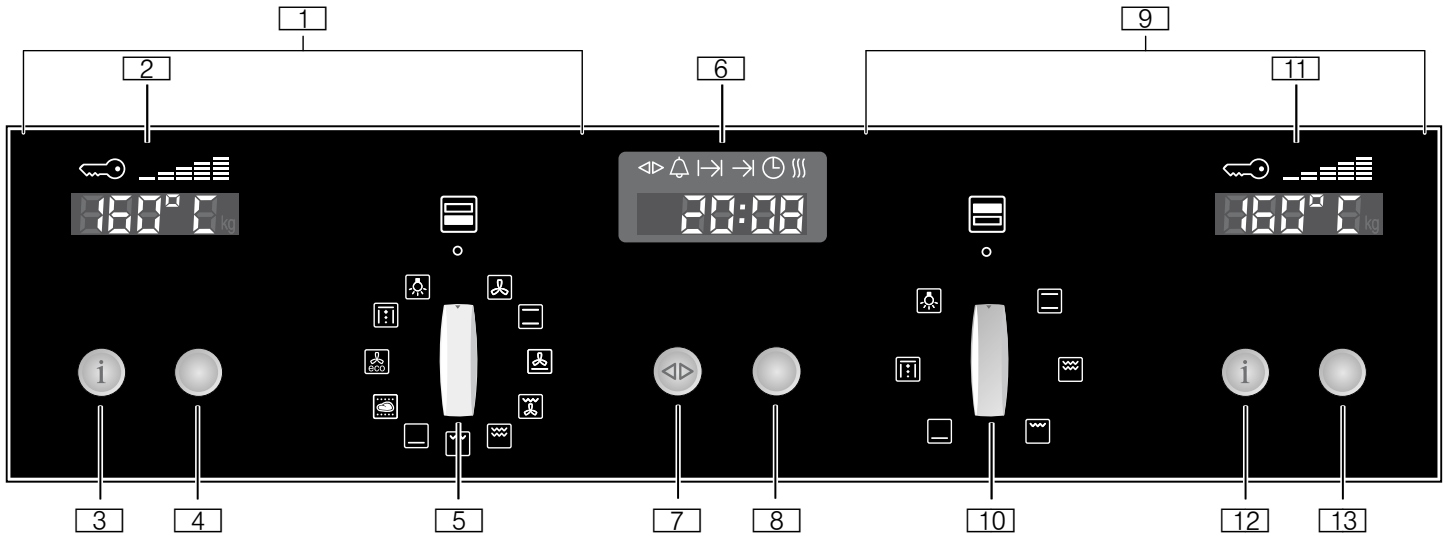
- the control panel
- the operating modes

## Control panel



Controls and indicators	Use/meaning
<b>Main oven</b> 	
<b>1</b> 	Main oven
<b>2</b>	Temperature display Cooking compartment temperature indicator and heating indicator
<b>3</b> <b>i</b>	Information button Displays the current temperature while the appliance is heating up (see section: Switching on the appliance) Calls up the Basic settings menu (see section: Changing the basic settings)
<b>4</b>	Temperature selector Sets the temperature (see section: Switching on the appliance) Changes the settings in the Basic settings menu (see section: Changing the basic settings)
<b>5</b>	Operating mode selector Selects the required operating mode (see section: Switching on the appliance)
<b>Electronic clock (Rapid heat up)</b>	
<b>6</b>	Electronic clock display Displays the time; also includes clock functions and Rapid heat up (see section: Electronic clock)
<b>7</b> 	Clock function button Selects the required clock function or Rapid heat up (see section: Electronic clock)
<b>8</b>	Rotary selector Selects the settings within each clock function or switches on Rapid heat up (see section: Electronic clock)
<b>Top oven</b> 	
<b>9</b> 	Top oven
<b>10</b>	Operating mode selector Selects the required operating mode (see section: Operating the appliance)
<b>11</b>	Temperature display Cooking compartment temperature indicator and heating indicator
<b>12</b> <b>i</b>	Information button Displays the current temperature while the appliance is heating up (see section: Switching on the appliance)
<b>13</b>	Temperature selector Sets the temperature (see section: Switching on the appliance)

### Pop-out operating knob











out.

The rotary, temperature and operating mode selectors can all be popped out. Push the required operating knob to pop it in or

## Operating modes







Here is an overview of the operating modes of your appliance.

### Main oven

Operating mode	Use
 CircoTherm®	For baking and roasting on one or more levels
 Top/bottom heating	For baking and roasting on one level. Ideal for cakes with moist toppings (e.g. cheesecake)
 Pizza setting	For frozen ready-made products and dishes which require a lot of heat from underneath. (see section: Baking)
 Circo-roasting	For poultry and larger pieces of meat
 Full-surface grill	For large amounts of flat, small items for grilling (e.g. steaks, sausages)
 Centre-area grill	For small amounts of flat, small items for grilling (e.g. steaks, bread)
 Bottom heating	For food and baked items on which you want a crust to form, or which need more browning on the underside. Switch on Bottom heating at the end of the baking time for a short time only.
 Slow cooking	For tender pieces of meat that are to be cooked medium/medium rare or à point
 CircoTherm® eco*	For energy-efficient baking and roasting on one level, without the need to preheat.
 Oven cleaning	For regeneration of the self-cleaning surfaces in the cooking compartment
 Interior lighting	Provides assistance when cleaning and caring for the cooking compartment

\* Type of heating used to determine the energy efficiency class in accordance with EN 50304

### Top oven

Operating mode	Use
 Top/bottom heating	Ideal for cakes with moist toppings (e.g. cheesecake)
 Full-surface grill	For large amounts of flat, small items for grilling (e.g. steaks, sausages)
 Centre-area grill	For small amounts of flat, small items for grilling (e.g. steaks, sausages)
 Bottom heating	For food and baked items on which you want a crust to form, or which need more browning on the underside
 Oven cleaning	For regeneration of the self-cleaning surfaces in the cooking compartment
 Interior lighting	Provides assistance when cleaning and caring for the cooking compartment

# Your accessories

In this section, you will find information on

- Your accessories
- the correct way to insert the accessories into the cooking compartment
- the shelf positions
- the optional accessories

## Accessories

The following accessories are included with your appliance:



### Wire rack

for baking in baking tins, roasting in roasting dishes and grilling



### Universal pan, enameled

for baking moist cakes, roasting, grilling and collecting drops of liquid during cooking

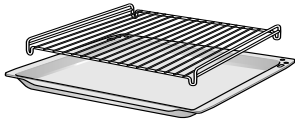

### Insert grid

for roasting and grilling

**Note:** The wire insert is always used together with the universal pan. In this combination, the wire insert is placed in the universal pan.

**Note:** The baking tray and universal pan may become distorted when the appliance is in operation. This is caused by the considerable temperature differences acting on the accessories. These differences may occur if only a part of the accessory is covered with food, or if frozen items such as pizza are placed on the accessory.

## Inserting accessories

The accessories are equipped with a locking function. The locking function prevents the accessories from tilting when they are pulled out. The accessories must be inserted into the cooking compartment correctly for the tilt protection to work properly.

When inserting the wire rack, check

- that the lug (a) is pointing downwards
- that the lug (a) is in the rear part of the wire rack

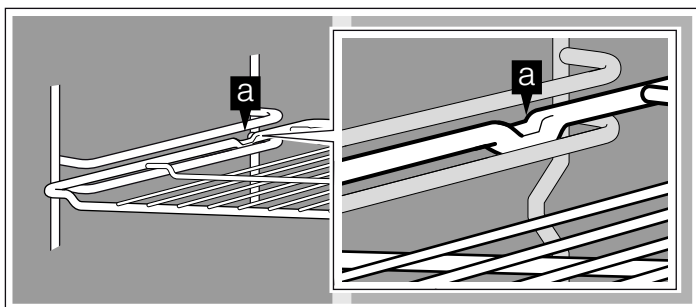

When inserting the baking tray or the universal pan, check

- that the lug (a) is in the rear part of the accessory
- that the sloping edge of the accessory faces towards the appliance door when it is inserted

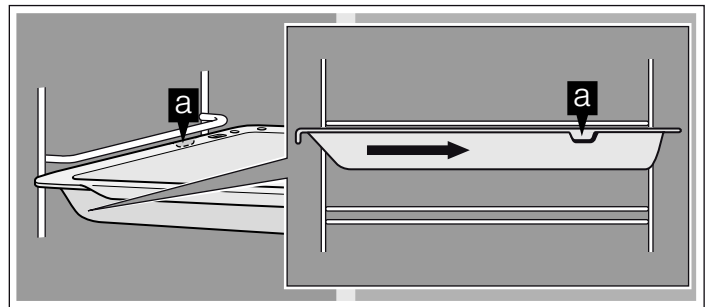

## Shelf positions

The shelf positions in the cooking compartment are counted from the bottom up.

**Note:** When baking and roasting with CircoTherm® (⊗), do not use shelf position 2. This will adversely affect air circulation and your baking and roasting results will not be as good.

### Bottom oven

The cooking compartment in the bottom oven has four shelf positions.

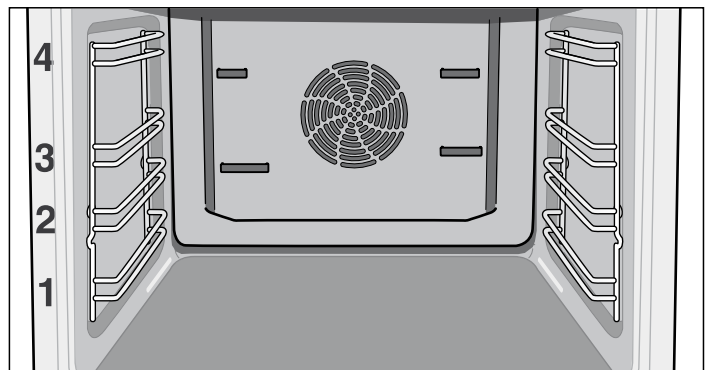

### Top oven

The cooking compartment of the top oven has two shelf positions.

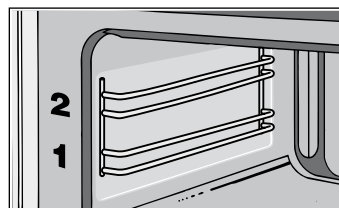



## Optional accessories

You can buy optional accessories from your after-sales service or from specialist retailers. A comprehensive range of products for your appliance can be found in our brochures or on our home page.

Optional accessories	Ordering no.
System steamer	N8642X3
Roasting pan, enamelled	Z1272X0
Glass pan	Z1262X0
CLOU® 4x telescopic shelf with full extension	Z1755X2
Bread-baking stone	Z1913X0

## Before using the appliance for the first time

In this section, you can read about

- How to set the clock after connecting up your appliance
- How to clean your appliance before using it for the first time

### Setting the clock

**Note:** When you press the <> clock function button, you have 3 seconds to set the clock using the rotary selector. Should this have been insufficient for you, you can amend the clock time later.

0:00 flashes in the clock display.

1. Briefly press the <> clock function button to go to the setting mode.  
The <> and ☑ symbols light up. 12:00 appears in the clock display.
2. Set the current time using the rotary selector.  
Your setting is accepted after 3 seconds.

### Changing the clock

To subsequently change the time, press the <> clock function button repeatedly until the <> and ☑ symbols light up again. Change the time with the rotary selector.



### Cleaning the appliance

Clean your appliance before using it for the first time.

1. Remove the accessories from the cooking compartment.
2. Completely remove any residual packaging (e.g. chips of polystyrene) from the cooking compartment.
3. Clean the accessories and cooking compartment with hot soapy water (see section: Cleaning and care).
4. Keep the kitchen ventilated while the appliance is heating up. Heat with Top/bottom heat ☐ at 240 °C for 60 minutes.
5. Afterwards, wipe the cooled cooking compartment with hot, soapy water.
6. Clean the outside of the appliance with a soft, damp cloth and soapy water.

## Operating the appliance

In this section, you can read about

- how to switch your appliance on and off
- how to select an operating mode and temperature
- how you can change the basic settings
- when your appliance switches off automatically

### Switching on the appliance

1. Turn the operating mode selector until the desired operating mode is selected.  
A default temperature appears on the temperature display.
2. Turn the temperature selector to change the default temperature.

#### Notes

- You can only start the operating mode ☐ Low-temperature cooking if neither *H* nor *h* are shown in the temperature display.
- If no default temperature is displayed, the temperature of your selected operating mode is a fixed setting. You cannot change this temperature.

Operating mode	Default temperature in °C	Temperature range in °C
☐ CircoTherm®	160	40 - 200

\* Turn the temperature selector beyond 275 °C. 175 appears in the temperature display

Operating mode	Default temperature in °C	Temperature range in °C
Top/bottom heat	170	50 - 275
CircoTherm intensive	220	50 - 275
Circo-roasting	170	50 - 250
Full-surface grill	220	50 - 275
Full-surface grill (intensive)**	Fixed setting	
Centre-area grill	180	50 - 275
Centre-area grill (intensive)**	Fixed setting	
Bottom heat	200	50 - 225
Low-temperature cooking	Fixed setting	
CircoTherm® Eco	160	40 - 200
Oven cleaning	Fixed setting	
Interior lighting	Fixed setting	

\* Turn the temperature selector beyond 275 °C. *int* appears in the temperature display

### Current temperature

Press the **i** info button. The current temperature appears for 3 seconds.

**Note:** The current temperature can only be displayed with operating modes with a default temperature.

### Heating indicator

The heating indicator displays the rising temperature in the cooking compartment.

- Temperature reached (figure A)
- Appliance reheating (figure B)

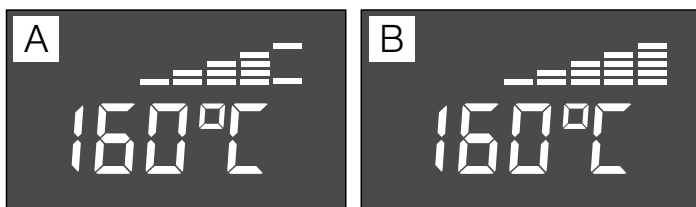

### Switching off the appliance

Turn the operating mode selector to the **O** position. The appliance is switched off.

The appliance has a cooling fan. After the appliance is switched off, the cooling fan may continue to run.

You can see in the temperature display whether there is high or low residual heat in the cooking compartment.

Temperature display	Meaning
<i>H</i>	Residual heat high (above 120 °C)
<i>h</i>	Residual heat low (between 60 °C and 120 °C)

## Changing the basic settings

Your appliance has various basic settings, which are preset at the factory. You can, however, change these basic settings as required.

The basic settings for both ovens can be activated using the operating controls on the bottom oven.

To change the basic settings,

- the appliance must be switched off.
- the childproof lock and timer function must be switched off

1. Press and hold the **i** info button for 3 seconds to go to the basic settings menu.

In the temperature display, *c 10* appears.

2. Press the **i** info button briefly and repeatedly until the setting symbol for the current basic setting of a submenu is displayed in the temperature display (e.g. *c 32*).

3. Using the temperature selector, set the required basic setting within a submenu (e.g. *c 33*).

4. Press and hold the **i** info button for 3 seconds. Your basic setting is saved.

You can change the following basic settings:

### Basic settings menu

Submenu	Basic setting	Setting symbol
Childproof lock	Appliance controls unlocked	<i>c 10</i>
	Appliance controls locked	<i>c 11</i>
	Appliance controls permanent lock	<i>c 21</i>
Audible signal	Audible signal off	<i>c 30</i>
	Audible signal 30 seconds	<i>c 31</i>
	Audible signal 2 minutes	<i>c 32</i>
	Audible signal 10 minutes	<i>c 33</i>

### Automatic safety cut-out

The automatic safety cut-out is activated if your appliance is switched on and you have not made any settings for a long time.

The length of time after which your appliance switches itself off depends on the settings that you make.

*000* flashes in the temperature display. Appliance operation is interrupted.

Turn the operating mode selector to the **O** position to deactivate it.

# Electronic clock

In this section, you can read about

- how to set the timer
- how to switch your appliance off automatically (cooking time and end of operation)
- how to switch your appliance on and off automatically (preset operation)
- how to set the time
- find out how to activate rapid heat up

## Clock display

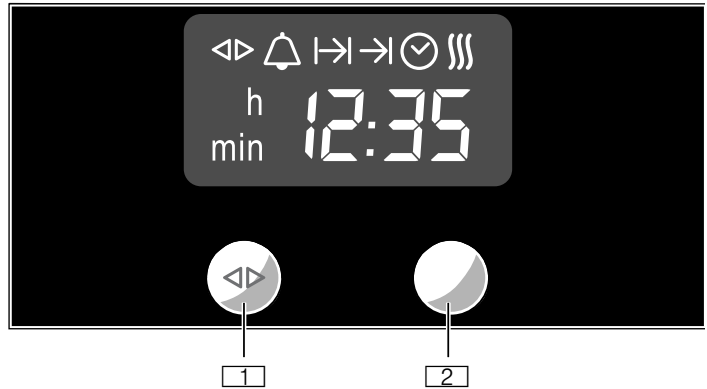

- 1 Clock function button
- 2 Rotary selector

Clock function	Use
Timer	You can use the minute minder as an egg timer or a kitchen timer. The appliance does not switch on or off automatically
Cooking time	Bottom oven : The oven switches off automatically after a set cooking time (e.g. <b>1:30</b> hours).
End of operation	Bottom oven : The oven switches off automatically at a set time (e.g.: <b>12:30</b> ).
Preset operation	Bottom oven : The oven switches on and off automatically. Cooking time and end of operation have been combined.
Clock	Sets the clock
Rapid heat up	Bottom oven : Decreases the preheat time

### Notes

- Between the times **22:00** and **5:59** the clock display is dimmed if you do not make any settings in that period or no clock function is activated.
- When you set a clock function, the time interval increases when you set higher values (e.g. cooking time up to **1:00h** to the minute, using **1:00h** to the nearest 5 minutes).
- For the minute minder, cooking time, end of operation and preselection mode clock functions, a signal sounds when the settings have elapsed and the or symbol flashes. To cancel the audible signal before it ends, press the clock function button.
- Briefly press the clock function button to select a clock function. You then have 3 seconds to set the selected clock function. After this time, the setting mode is exited automatically.

### Timer

1. Press the clock function button repeatedly until the and symbols light up.
2. Set the duration using the rotary selector (e.g. **5:00** minutes). The setting is applied automatically. Then the clock is displayed again and the minute minder starts counting down.

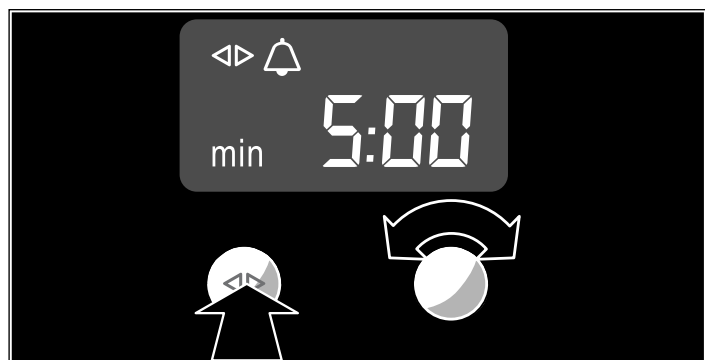

### Cooking time

Automatic switch-off after a cooking time setting has elapsed.

1. Set the operating mode and temperature for the bottom oven. The bottom oven starts heating.
2. Press the clock function button repeatedly until the and symbols light up.

- Set the cooking time with the rotary selector (e.g. **1:30** hours).  
The setting is applied automatically. The time is then displayed again and the set cooking time counts down.

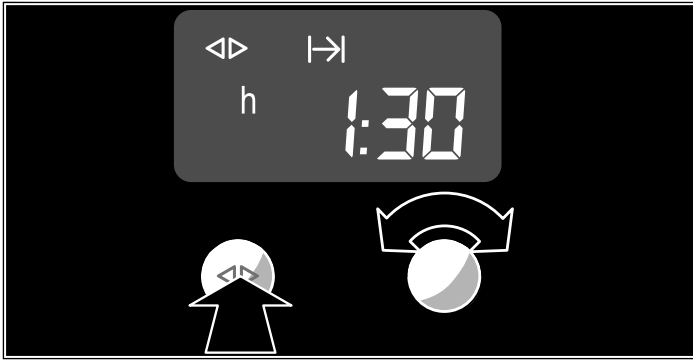

Once the cooking time has elapsed, the bottom oven switches off automatically.

- Turn the operating mode and temperature selector back to the 0 zero position.
- Press the clock function button to exit the clock function.

### End of operation

Automatic switch-off at a set time.

- Set the operating mode and temperature for the bottom oven.  
The bottom oven starts heating.
- Press the clock function button repeatedly until the and symbols light up.
- Set the end of operation using the rotary selector (e.g. **12:30** o'clock).  
The setting is applied automatically. The clock is then displayed again.



The bottom oven switches off automatically at the time set for the end of operation.

- Turn the operating mode and temperature selector back to the 0 zero position.
- Press the clock function button to exit the clock function.

### Preset operation

The bottom oven switches on automatically and switches off at the time preselected for the end of operation. To set this function, combine the cooking time and end of operation clock functions.

Bear in mind that food which spoils easily should not be left in the cooking compartment for too long.

- Set the operating mode and temperature for the bottom oven.  
The bottom oven starts heating.
- Press the clock function button repeatedly until the and symbols light up.
- Set the cooking time with the rotary selector (e.g. **1:30** hours).  
The setting is applied automatically.

- Press the clock function button repeatedly until the and symbols light up.
- Set the end of operation using the rotary selector (e.g. **12:30** o'clock).  
The bottom oven switches off and waits until the correct time to switch on (in the example at **11:00**). The bottom oven switches off automatically at the time set for the end of operation **12:30**.
- Turn the operating mode and temperature selector back to the 0 position.
- Press the clock function button to exit the clock function.

### Setting the clock

You can only change the clock when no other clock function is active.

- Press the clock function button repeatedly until the and symbols light up.
- Set the clock using the rotary selector.  
The setting is applied automatically.



### Rapid heat up

With CircoTherm®, you can shorten the heat up time if your selected temperature setting is higher than 100 °C.

**Note:** During Rapid heat up, do not place any food in the cooking compartment for as long as the symbol is lit.

- Set the operating mode and temperature for the bottom oven.  
The bottom oven starts heating.
- Press the clock function button repeatedly until the and symbols light up and **OFF** is displayed in the clock display.
- Turn the rotary selector clockwise.  
In the clock display, **On** is displayed and the symbol lights up. Rapid heat up is activated for the bottom oven.

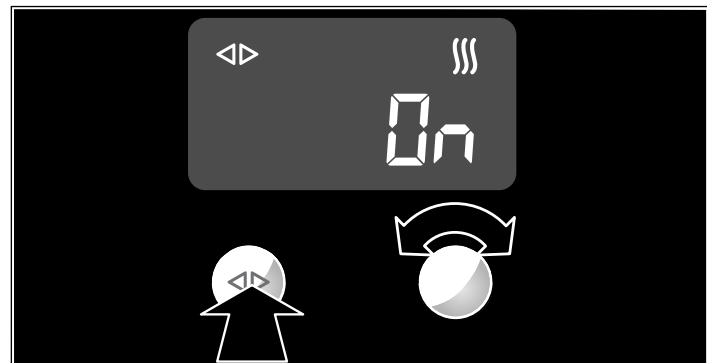

After reaching the set temperature, Rapid heat up switches off. The symbol goes out.

## Checking, correcting or deleting settings

1. To check your settings, press the  clock function button repeatedly until the corresponding symbol lights up.
2. If necessary, you can correct your setting using the rotary selector.
3. If you wish to cancel your setting, turn the rotary selector anti-clockwise to the original value.

## Childproof lock

In this section, you can read about

- how to lock your appliance
- how to lock your appliance permanently

The childproof locks for both ovens can be activated using the operating controls on the  bottom oven.

In order for you to be able to set the childproof lock,

- the appliance must be switched off.
- no clock function should be active

### Lock

Once it has been locked, the appliance cannot be switched on accidentally or by unauthorised users (e.g. by children playing).

To switch the appliance on again, you must unlock it. After appliance operation, the appliance is not automatically locked. Lock it again if necessary or activate the permanent lock.

#### Lock appliance

1. Switch off the appliance.
2. Press and hold the **i** info button until **c 10** appears in the temperature display.
3. Turn the temperature selector until **c 11** appears on the temperature display.
4. Press and hold the **i** info button until the  symbol appears in the temperature display.

**Note:** If you try to switch the appliance on when it is locked, **-5-** appears in the temperature display.

#### Unlocking the appliance

1. Press and hold the **i** info button until **c 11** appears in the temperature display.
2. Turn the temperature selector until **c 10** appears on the temperature display.
3. Press and hold the **i** info button until the  symbol goes out.

### Permanent lock

Once it has been permanently locked, the appliance cannot be switched on accidentally or by unauthorised users (e.g. by children playing).

To switch the appliance on, you must interrupt the permanent lock briefly. After you have switched your appliance off, it locks again automatically.

#### Locking the appliance permanently

1. Switch off the appliance.
2. Press and hold the **i** info button until **c 10** appears in the temperature display.
3. Turn the temperature selector until **c 21** appears on the temperature display.
4. Press and hold the **i** info button for 3 seconds.  
Your appliance will be locked after 30 seconds. The  symbol appears on the temperature display.

**Note:** If you try to switch the locked appliance on, **-5P** appears in the temperature display.

#### Interrupting permanent lock

1. Press and hold the **i** info button until **c 21** appears in the temperature display.
2. Turn the temperature selector until **c 20** appears on the temperature display.
3. Press and hold the **i** info button until the  symbol goes out.  
The permanent lock is interrupted.
4. Switch the appliance on within 30 seconds.  
After the permanent lock is switched off, it is reactivated after 30 seconds.

#### Unlocking the appliance permanently

1. Press and hold the **i** info button until **c 21** appears in the temperature display.
2. Turn the temperature selector until **c 20** appears on the temperature display.
3. Press and hold the **i** info button until the  symbol goes out.
4. Within 30 seconds, press and hold the info button again for 3 seconds.
5. Turn the temperature selector until **c 10** appears on the temperature display.
6. Press and hold the **i** info button for 3 seconds.  
The appliance is permanently unlocked.

# Baking

In this section, you will find information on

- Baking on one level
- Baking on two or more levels
- The baking table
- The baking table for ready-made products
- Tips and tricks for baking

**Note:** Do not use shelf height 2 when baking with  CircoTherm®. The air circulation is impaired and this will have a negative effect on your baking.

We recommend that you use dark-coloured metal baking tins.

Tinplate and glass dishes increase the baking time required and the cake will not brown evenly.

If you wish to bake using tinplate tins and  Top/bottom heat, you should use shelf position 1.

Always slide the universal pan in carefully as far as it will go and make sure that the sloping edge is facing the appliance door.

## Baking on one level

If you are baking on one level with  CircoTherm®, always place a round tin in the centre of the wire rack (figure A) and always place a loaf tin diagonally (figure B).

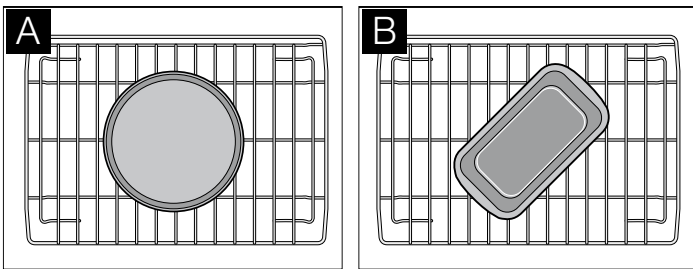

If you are baking on one level with  CircoTherm®, always place two round baking tins diagonally to each other on the wire rack (figure C).

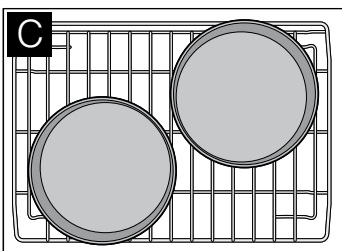

## Baking on two or more levels

If you are baking on more than one level, only use the  CircoTherm® operating mode.

Bear in mind that your items may brown at different rates on each level. The items on the top level will brown more quickly and can be taken out earlier.

### Two baking tins on two levels

When baking with two round baking tins or two baking trays, slide a wire rack in at shelf position 1 and a wire rack in at shelf position 3.

Place the lower baking tin to the left (figure A) and the upper baking tin to the right (figure B) on the wire rack.

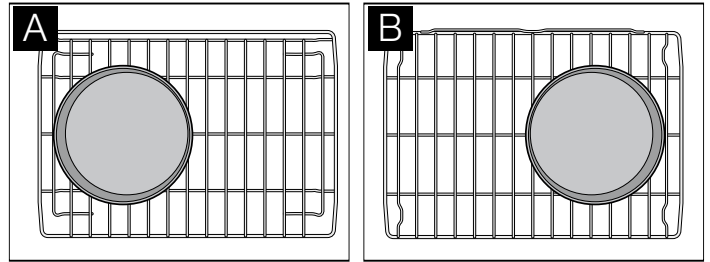

### Four baking tins on two levels

When baking with four round baking tins, slide a wire rack in at shelf position 1 and a wire rack in at shelf position 3.

Always place baking tins on the wire rack (figure C).

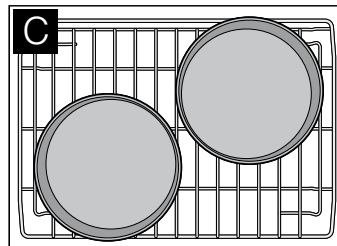

















## Baking table

The details given in the table are guidelines and apply to dark baking tins. The values may vary depending on the type and amount of the dough/mixture and on the baking tin.

We recommend that you set the lower of the specified temperatures the first time. Lower temperatures will generally allow more even browning.































































































If you are baking according to your own recipe, use similar recipes in the table as a guide.

Observe the notes in the table about preheating.

Meal	Oven	Setting	Level	Temperature	Time in minutes
Victoria sponge cake			1	160 - 170*	25 - 30
			2	160 - 170*	20 - 30
			1	160 - 170*	25 - 30
			1 + 3	150 - 160*	25 - 35
Scones			1	180 - 200*	10 - 15
			3	210 - 220*	8 - 10
			1	200 - 210*	10 - 12
			1 + 3	180 - 200*	10 - 15

\* Preheat oven

\*\* Preheat the oven to 130 °C

Meal	Oven	Setting	Level	Temperature	Time in minutes
Small cakes			1	160 - 170*	20 - 30
			3	150 - 160*	25 - 35
			1	160 - 170*	25 - 30
			1 + 3	150 - 160*	25 - 35
Light fruit cake			1	140 - 150*	80 - 100
			2	160 - 170*	70 - 90
Rich fruit cake			1	140 - 150*	210 - 240
			2	140 - 150*	210 - 240
Jam tarts			1	190 - 200*	15 - 20
			3	200 - 210*	15 - 20
			1	190 - 210*	15 - 25
			1 + 3	190 - 200*	20 - 25
Swiss roll			1	180 - 190*	10 - 15
			2	190 - 200*	10 - 15
			1	180 - 190*	10 - 15
Tart			1	160 - 170*	50 - 60
			1	180 - 190*	45 - 55
			1 + 3	160 - 170*	50 - 60
Pies			1	170 - 180*	65 - 75
			1	170 - 180*	65 - 75
			1 + 3	170 - 180*	65 - 75
Biscuits			1	160 - 170*	15 - 20
			2	170 - 180*	15 - 20
			1	170 - 180*	10 - 15
			1 + 3	160 - 170*	20 - 25
			1 + 3 + 4	160 - 170*	20 - 25
Meringue			1	80*	100 - 130
			3	80*	100 - 130
			1	80*	110 - 140
Pavlova			1	90 - 100**	90 - 120
			3	80 - 90**	90 - 120
Fruit crumble			1	170 - 180*	45 - 55
			2	190 - 200*	45 - 55
Yorkshire pudding			2	200 - 230*	15 - 20
			1	210 - 220*	10 - 15
Vol au vents			1	190 - 200*	20 - 30
			1	180 - 190*	20 - 25
Quiche			1	180 - 200*	45 - 55
			1	180 - 190*	30 - 40
(White) bread			1	220 - 230*	20 - 25
			1	200 - 220*	20 - 25
Homemade pizza			1	190 - 200*	20 - 30
			1	180 - 190*	15 - 20
			1 + 3	180 - 190*	35 - 45
Jacket potatoes			1	160 - 170	60 - 70
			1	160 - 170	50 - 55
			1 + 3	160 - 170	65 - 75

\* Preheat oven

\*\* Preheat the oven to 130 °C

## Baking table for ready-made products

### Notes

- Use the universal pan
- Only use greaseproof paper that is suitable for the selected temperature
- Spread chips out in a single layer
- Turn frozen potato products half way through the baking time
- Only season frozen potato products after they have finished baking
- Leave a little space between the dough when baking bread rolls. Do not place too many in the universal pan
- Cover the lasagne with plenty of cheese so that the top browns evenly





























































- Do not use frozen products with freezer burn
- Do not use frozen products that are heavily frosted
- Follow the manufacturer's instructions.

The details given in the table are guidelines and apply to the universal pan.

We recommend that you set the lower of the specified temperatures the first time. Lower temperatures will generally allow more even browning.

If you are baking on more than one level, only use the  CircoTherm® operating mode.

Observe the notes in the table about preheating.

Meal	Oven	Setting	Level	Temperature in °C	Time in minutes
Frozen pizza			1	180 - 200*	15 - 25
			1	180 - 200*	10 - 20
			1	180 - 200*	10 - 20
			1 + 3	170 - 190*	20 - 30
Chilled pizza			2	190 - 210*	10 - 15
			1	190 - 200	10 - 15
Part-baked white bread			1	180 - 190*	10 - 20
			1	180 - 190*	5 - 15
			1	190 - 200*	5 - 15
			1 + 3	170 - 180*	15 - 20
Oven chips			1	180 - 200*	25 - 30
			1	180 - 190*	20 - 25
			1	190 - 200*	25 - 30
Potato wedges			1	180 - 190*	20 - 25
			1	180 - 190*	15 - 20
			1	190 - 200*	15 - 20
Croquettes			1	180 - 190*	25 - 30
			1	180 - 190*	20 - 25
			1	190 - 200*	20 - 25
Fish fingers			1	180 - 200*	15 - 20
			1	180 - 200*	10 - 15
			1	190 - 200*	10 - 15
Lasagne, frozen (400 g)			1	180 - 190*	40 - 45
			1	180 - 190*	35 - 40
Lasagne, frozen (1200 g)			1	180 - 190*	45 - 50
			1	180 - 190*	40 - 45
Lasagne, chilled (400 g)			1	170 - 180*	35 - 40
			2	190 - 200*	35 - 40
Lasagne, chilled (1200 g)			1	170 - 180*	40 - 45
			2	190 - 200*	40 - 45

\* Preheat oven

## Tips and tricks

The cake is too light in colour

Check the shelf height.

Check whether you have used the bakeware that we have recommended.

Place your tin on the wire rack and not on the baking tray.

If the shelf height and the bakeware are correct, then you should either extend the baking time or increase the temperature.



The cake is too dark	Check the shelf height. If the shelf height is correct, you should either shorten the baking time or reduce the temperature.
The cake is unevenly browned in the baking tin	Check the shelf height. Check the temperature. Make sure that your baking tin is not placed directly in front of the air outlets in the rear panel of the cooking compartment. Check that the baking tin is in the correct position on the wire rack.
The cake is too dry	Set a slightly higher temperature and a slightly shorter baking time.
The cake is too moist in the centre	Set a slightly lower temperature. Note: Higher temperatures may not mean shorter baking times (cooked on the outside, but not on the inside). Select a longer baking time and allow the cake mixture to prove for longer. Add less liquid to the mixture.
The cake collapses when you take it out of the oven	Use less liquid for the mixture. Set a longer baking time or a slightly lower temperature.
The specified baking time is not correct	For small items, check the quantity on the baking tray. Small items must not be touching each other.
Frozen products are not browned evenly after baking	Check whether the frozen product is unevenly pre-browned before baking. This uneven browning will remain after the baking time.
Several cakes on one level are unevenly browned	Check the position of the baking tins on the wire rack.
Frozen products are not browned, not crispy or the specified times are not correct	Remove ice from frozen products before baking. Do not use frozen products that are heavily frosted
Saving energy	Only preheat the appliance when it is specified in the baking table that you should do so. Use dark baking tins as these absorb the heat better. Make use of the residual heat with longer baking times and switch the oven off 5 - 10 minutes before the end of the baking time.

## Roasting and braising

In this section, you will find information on

- Roasting
- Braising
- Tables for roasting and braising
- Tips and tricks

**⚠ There is a risk of injury if you use roasting dishes that are not heat-resistant!**

Only use roasting dishes that are marked as being suitable for use in the oven.

Do not use shelf height 2 when roasting with  CircoTherm®. The air circulation would be impaired and this will have a negative effect on your roast.

### Roasting

Roasting dish without a lid is used for roasting.

While the meat is roasting, the liquid in the roasting dish will evaporate. If necessary, carefully add more hot liquid.

When you are roasting using  Top/bottom heat, turn the roast approximately half to two thirds of the way through the roasting time.

### Roasting in the universal pan

Juices escape from the roasting meat and are collected in the universal pan. You can use these juices as the basis for a tasty gravy.

Deglaze the pan of the juices with hot water, stock, wine or similar. Bring to the boil, thicken with cornflour, season and pass through a sieve if necessary.

You can also cook side dishes (e.g. vegetables) at the same time as roasting meat in the universal pan.

For smaller joints, you can use a smaller roasting dish instead of the universal pan. Place this directly on the wire rack.

### Roasting in the universal pan with insert grid

Place the wire insert in the universal pan with the lower area facing downwards and slide them in together at the same shelf position.

For fatty meat and poultry, add 1/8 to 1/4 litre water to the universal pan, depending on the size and type of the joint.

### Braising

For braising, a roasting dish with a lid is used. Ensure that the roasting dish and lid fit together well and close properly.

First, sear the meat if required.

Add the meat, vegetables and liquid to the roasting dish in equal proportions and place the dish with the lid closed on the wire rack at shelf position 1.

While the meat is braising, the liquid in the roasting dish will evaporate. Pour in more liquid if required.

## Tables for roasting and braising

The details given in the table are guidelines and apply to food placed in a cold oven and for meat taken directly from the refrigerator.

### Poultry

The information in the tables applies to unstuffed poultry. Turn the poultry after half of the cooking time.

### Lean meat

Coat lean meat with fat or oil as required and cover it with strips of bacon.

### Cooking time and temperature

The cooking time and temperature depend on the size, height, type and quality of the food and the roasting dish.

























































As a general rule: the larger the item, the lower the temperature and the longer the roasting time.

You should set the lower of the specified temperatures the first time. Lower temperatures will generally allow more even browning.















The values for cooking time apply to 0.5 - 2 kg of food. For greater weights, reduce the temperature and increase the cooking time. For multiple pieces, apply the cooking time for the weight of the heaviest piece.

### Standing time













At the end of the cooking time, switch the oven off and leave the roast to stand for approximately 10 minutes in the cooking compartment with the door closed. The recommended standing time is not included in the cooking times specified.

Meal	Oven	Setting	Level	Temperature in °C	Time, min. per 500 g + add. time
<b>Beef</b>					
Slow roast joint			1	140	40 + 40
			2	150	40 + 40
Top side / top rump			1	160	30 + 25
			2	190	30 + 25
<b>Lamb</b>					
Leg			1	170	30 + 25
			2	200	30 + 25
Shoulder (bone-in)			1	170	25 + 20
			2	200	25 + 20
Shoulder (boned and rolled)			1	170	30 + 25
			2	200	30 + 25
Rack of lamb			1	180	25 + 25
			2	200	25 + 25
<b>Pork</b>					
Roast joint			1	180	35 + 35
			2	180	35 + 35
Loin joint			1	180	30 + 30
			2	180	30 + 30
Belly			1	160	30 + 25
			2	190	30 + 25
<b>Gammon</b>					
Joint			1	160	30 + 30
			2	190	30 + 30
<b>Chicken</b>					
Whole chicken			1	170 - 180	20 + 25
			2	190 - 200	20 + 25
Portion (boned)			1	190	20 + 25
			2	200 - 210	20 + 25
Quarter			1	190	20 + 25
			2	200 - 210	20 + 25
Duck			1	180	20 + 20
			2	190 - 200	20 + 20

\* + time for Yorkshire pudding

Meal	Oven	Setting	Level	Temperature in °C	Time, min. per 500 g + add. time
<b>Turkey</b>					
Drumstick			1	180	20 + 20
Crown			1	160	25 + 20
Whole, 3 - 4 kg			1	160 - 170	15 + 10
Whole, 4.5 - 8 kg			1	150 - 160	13 + 10
Whole, 8.5 - 12 kg			1	140 - 150	12 + 10
<b>Complete Meal</b>					
with beef			1 + 3	160	30 + 25*
with chicken			1 + 3	180	20 + 25

\* + time for Yorkshire pudding

Casseroles	Oven	Setting	Level	Temperature in °C	Time, min. per 500 g + add. time
Diced meat (beef, pork, lamb, chicken)			1	140	40 + 80
			1	140*	40 + 80
Braising steak			1	140	45 + 80
			1	140*	45 + 80
Chicken pieces (boned)			1	140	50 + 70
			2	140*	50 + 70



\* Preheat oven

## Tips and tricks

Crust too thick and/or roast too dry	Reduce the temperature or shorten the roasting time. Check the shelf height.
Crust too thin	Increase the temperature or switch on the grill briefly at the end of the roasting time.
The meat is not cooked right through	Remove any accessories that are not required from the cooking compartment. Increase the roasting time. Check the core temperature of the joint using a meat thermometer.
Steam in the cooking compartment is condensing on the appliance door	The steam dries during the course of the cooking. If there is an excessive volume of steam, you can carefully open the door briefly to dissipate the steam more quickly.
The meat is burned slightly during braising	Add the meat, vegetables and liquid to the roasting dish in equal proportions. The roasting dish and lid must fit together well and close properly. Reduce the temperature.

# Grilling

In this section, you will find information on

- Grilling in general
- Circo-roasting 
- Radiant grilling (Full-surface  and Centre-area grill )
- The grilling table

## Caution!

Material damage due to effect of heat: The temperature generated in the cooking compartment is very high. Keep the appliance door closed when using the grill. Never grill with the appliance door open.

## Notes

- It is preferable to use the universal pan with wire insert for grilling
- Place the insert grid into the universal pan and slide the two in together at the shelf position specified in the grilling table
- Always place the food to be grilled in the centre of the wire rack
- If you are grilling more than one piece of meat, make sure that they are the same sort of meat and that they are of similar thickness and weight.
- Use the wire rack for particularly large quantities. Insert the wire rack at the shelf position indicated in the grilling table. To prevent the oven from becoming dirty, insert the universal pan one level lower.

## Circo-roasting

The  Circo-roasting operating mode is particularly suitable for poultry or meat (e.g. roast pork with crackling) that is to be crispy.

Turn large items of food after approximately half to two-thirds of the grilling time. For items of food with rind, place them on the wire rack rind-side down for the first half of the grilling time.

Pierce duck and goose skin under the wings and legs to allow the fat to escape.

Depending on the type of food you are cooking, the cooking compartment may become very dirty when you cook food using Circo-roasting. You should therefore clean the cooking compartment after every use so that the dirt does not become burnt on.

At the end of the cooking time, switch the grill off and leave the food to stand for approximately 10 minutes in the cooking compartment with the door closed. The recommended standing time is not included in the grilling times specified.

## Radiant grilling

For grilling large quantities of flat items, use the Full-surface  grill.

For grilling small quantities of flat items, use the  Centre-area grill. Place the food to be grilled in the centre of the wire rack. Using the Centre-area grill operating mode will save energy.

Brush the items to be grilled with a little oil according to taste.

Turn the grilling items half to two-thirds of the way through the grilling time.

You can influence the grilling result by changing the position of the wire rack.

### Wire rack position Application



Place the wire insert in the universal pan with the lower area facing downwards: Suitable for grill items that should be predominantly well-done



Place the wire insert in the universal pan with the lower area facing upwards: Suitable for grill items that should be cooked predominantly rare to medium-rare

**Note:** Always use the universal pan in the standard position (not the other way up).

















## Grilling table

The details given in the table are guidelines and apply to the enamelled universal pan with wire insert. The values may vary depending on the type and amount of items to be grilled.

You should set the lower of the specified temperatures the first time. A lower temperature will generally provide more even browning.



















































The values refer to food placed in the oven when it is cold and for meat taken directly from the refrigerator.

Meal	Oven	Setting	Level	Temperature in °C	Time in minutes
<b>Beef</b>					
Steaks, 2 - 3 cm thick			4	<i>int</i> *	1 <sup>st</sup> side: 9 - 12 2 <sup>nd</sup> side: 5 - 7
			2	<i>int</i> *	1 <sup>st</sup> side: 10 - 13 2 <sup>nd</sup> side: 6 - 8
Burgers, 1 - 2 cm thick			4	<i>int</i>	1 <sup>st</sup> side: 8 - 10 2 <sup>nd</sup> side: 6 - 8
			2	<i>int</i>	1 <sup>st</sup> side: 10 - 12 2 <sup>nd</sup> side: 6 - 8
<b>Lamb</b>					
Leg			2	170 - 190	120 - 150***
Shoulder (on the bone)			2	170 - 190	100 - 130***
Shoulder (boned and rolled)			2	170 - 190	120 - 150***

\* Preheat for 3 minutes

\*\* Turn frequently

\*\*\* Turn after half of the time

Meal	Oven	Setting	Level	Temperature in °C	Time in minutes
Steaks, 2 - 3 cm thick			4	<i>int</i>	1 <sup>st</sup> side: 5 - 7 2 <sup>nd</sup> side: 3 - 5
			2	<i>int</i>	1 <sup>st</sup> side: 6 - 8 2 <sup>nd</sup> side: 4 - 6
Chops, 2 - 3 cm thick			4	<i>int</i>	1 <sup>st</sup> side: 6 - 8 2 <sup>nd</sup> side: 4 - 7
			2	<i>int</i>	1 <sup>st</sup> side: 7 - 9 2 <sup>nd</sup> side: 5 - 8
<b>Pork</b>					
Roast joint			2	180 - 200	120 - 150***
Steaks, 1 - 2 cm thick			4	<i>int</i> *	1 <sup>st</sup> side: 8 - 10 2 <sup>nd</sup> side: 5 - 8
			2	<i>int</i> *	1 <sup>st</sup> side: 9 - 12 2 <sup>nd</sup> side: 6 - 8
Chops, 2 - 3 cm thick			4	<i>int</i>	1 <sup>st</sup> side: 10 - 12 2 <sup>nd</sup> side: 8 - 10
			2	<i>int</i>	1 <sup>st</sup> side: 10 - 13 2 <sup>nd</sup> side: 8 - 12
Burgers, 1 - 2 cm thick			4	<i>int</i>	1 <sup>st</sup> side: 8 - 10 2 <sup>nd</sup> side: 6 - 8
			2	<i>int</i>	1 <sup>st</sup> side: 10 - 12 2 <sup>nd</sup> side: 6 - 8
Sausages, 2 - 4 cm thick			4	<i>int</i>	12 - 16**
			2	<i>int</i>	14 - 18**
<b>Gammon</b>					
Steaks, 1 - 2 cm thick			4	<i>int</i>	1 <sup>st</sup> side: 9 - 12 2 <sup>nd</sup> side: 5 - 7
			2	<i>int</i>	1 <sup>st</sup> side: 10 - 12 2 <sup>nd</sup> side: 5 - 7
<b>Chicken</b>					
Drumsticks			3	250	1 <sup>st</sup> side: 15 - 17 2 <sup>nd</sup> side: 10 - 13
			2	250	1 <sup>st</sup> side: 16 - 20 2 <sup>nd</sup> side: 12 - 15
Breast (boneless)			4	250	1 <sup>st</sup> side: 12 - 15 2 <sup>nd</sup> side: 7 - 10
			2	250	1 <sup>st</sup> side: 13 - 15 2 <sup>nd</sup> side: 8 - 10
Whole chicken			2	200 - 230	70 - 90***
Quarter			2	210 - 230	40 - 50***
<b>Fish</b>					
Whole fish, e.g. trout			3	220	1 <sup>st</sup> side: 10 - 15 2 <sup>nd</sup> side: 10 - 15
			2	220	15 - 25
Fillets			4	220	1 <sup>st</sup> side: 8 - 12 2 <sup>nd</sup> side: 7 - 10
			1	220	1 <sup>st</sup> side: 9 - 13 2 <sup>nd</sup> side: 8 - 12

\* Preheat for 3 minutes

\*\* Turn frequently

\*\*\* Turn after half of the time

# CircoTherm® eco

With the  "CircoTherm® eco" heating type, you can prepare many dishes on one level and save energy.

## Notes

- Place your dishes in the empty cooking compartment before it has heated up.
- Only open the appliance door during cooking if it is absolutely necessary.

The table contains a selection of dishes best suited to  CircoTherm® eco.

The details given in the table are guidelines and apply to the use of enamelled baking trays and universal pans as well as dark-coloured baking tins. The values may vary depending on the type and amount of dishes and on the baking tin used.

We recommend that you set the lower of the specified temperatures the first time. Lower temperatures will generally allow more even browning.

Dishes using CircoTherm® eco 	Accessories	Level	Temperature in °C	Cooking time in minutes	
<b>Cakes and pastries</b>					
Victoria sandwich	Wire rack + 2 tins ø 20 cm	1	170 - 180	25 - 35	
Light fruit cake	Wire rack + high round tin ø 20 cm	1	160 - 170	85 - 95	
Rich fruit cake	Wire rack + high round ø 23 cm or square tin 20 cm	1	130 - 140	180 - 190	
Fruit crumble	Wire rack + flat glass dish	1	170 - 190	45 - 50	
Swiss roll	Wire rack + swiss roll tin	1	180 - 190	10 - 20	
Apple tart	Wire rack + plate ø 20 cm or pie tin	1	190 - 200	65 - 75	
Scones	Baking tray	1	180 - 190	20 - 25	
Biscuits	Baking tray	1	170 - 190	15 - 25	
Jam tarts	Wire rack + 12-cup tin	1	190 - 200	20 - 25	
Soufflé	Wire rack + 1,2 l soufflé dish	1	180 - 190	40 - 50	
Pie	Wire rack + pie dish	1	190 - 200	50 - 60	
Jacket potatoes	Universal pan	1	160 - 170	70 - 80	
<b>Frozen convenience products</b>					
Pizza, frozen	With thin base	Universal pan	1	180 - 200	15 - 25
	With thick base	Universal pan	1	180 - 200	20 - 30
Chips	Universal pan	1	190 - 200	20 - 30	
Bread rolls/baguette	Prebaked	Universal pan	1	180 - 200	10 - 20
<b>Fish</b>					
Trout	2 pieces, approx. 500 g each	Universal pan	1	180 - 200	40 - 50
Fish filets	Approx. 100 g each	Wire rack + glass roasting dish with lid	1	180 - 190	30 - 40
<b>Casserole</b>					
Diced meat (beef, pork or lamb)	Wire rack + glass roasting dish with lid	1	160 - 170	120 - 150	
Braising steaks	Wire rack + glass roasting dish with lid	1	140 - 150	120 - 150	
<b>Meat</b>					
Beef	Slow roast joint, approx. 1 kg	Universal pan + insert grid	1	140 - 150	55 + 40
	Roast joint	Universal pan + insert grid	1	180 - 190	40 + 40
Lamb	Leg	Universal pan + insert grid	1	170 - 180	35 + 25
Pork	Roast joint	Universal pan + insert grid	1	180 - 190	40 + 35

# Low-temperature cooking

In this section, you will find information on

- Low-temperature cooking 
- Tips and tricks

Low-temperature cooking is a method of cooking slowly at low temperatures, and is also known as slow cooking.

Low-temperature cooking is ideal for all prime cuts of meat (e.g. tender portions of beef, veal, pork, lamb and poultry) that are to be cooked medium/medium rare or "à point". The meat will remain succulent and tender.

## Using Low-temperature cooking



### Notes

- Only use fresh, clean meat
- The meat will always look pink on the inside after Low-temperature cooking. This does not mean that the cooking time was too short
- Only use boned meat
- Do not use defrosted meat
- You can also use seasoned or marinated meat
- Always use shelf height 1 for Low-temperature cooking
- Do not cover the meat while it is cooking in the cooking compartment
- Do not turn pieces of meat during the low-temperature cooking process
- The size, thickness and type of meat will have a significant influence on the searing and low-temperature cooking times
- The properties of the pan and the heat output of the hotplate can influence the searing time
- Do not use the Low-temperature cooking mode together with the Preselection mode clock function

Only switch the Low-temperature cooking mode on when the cooking compartment has completely cooled down (room temperature).

If **H** or **h** and **III** appear alternately in the temperature display when the Low-temperature cooking mode is switched on, the cooking compartment has not cooled down completely.

Wait until the cooking compartment has cooled down and switch Low-temperature cooking on again.

1. Place a glass or porcelain plate on a wire rack and insert at shelf height 1 to warm the plate.
2. Switch on  Low-temperature cooking.  
During the heating up phase (15 - 20 minutes), **III** appears in the temperature display.
3. Remove fat and sinews from the meat.
4. Sear the meat on all sides to seal the meat and to create a roasted flavour.
5. When a signal sounds and  appears in the text display, place the meat on the glass or porcelain plate in the cooking compartment.
6. Take out the meat at the end of the cooking time and switch off the appliance.

**Note:** Meat cooked at a low temperature does not need to rest, and can easily be kept warm at a low temperature.

## Table for Low-temperature cooking

The information in the table contains only guide values. The searing time is for searing in a hot pan with fat.

Place the duck breast in a cold pan and fry the skin side first. Following Low-temperature cooking, insert at shelf height 3 and grill at 250 °C for 3 - 5 minutes until crispy.

You can find information on how to proceed, further instructions and recipes in the accompanying cookbook.

	Searing in minutes	Low-temperature cooking in minutes
<b>Pork</b>		
Fillet, whole (approx. 500 g)	5 - 6	100 - 120
Loin (approx. 1 kg, 4 - 5 cm thick)	5 - 6	120 - 150
Medallions (5 cm thick)	3 - 4	45 - 60
Loin steaks (2 - 3 cm thick)	2 - 3	30 - 45
<b>Beef</b>		
Fillet, whole (1.5 kg)	6 - 7	160 - 200
Sirloin (approx. 1.5 kg, 5 - 6 cm thick)	6 - 7	180 - 210
Centre-cut rump (6 - 7 cm thick)	6 - 7	240 - 300
Medallions (5 cm thick)	3 - 4	60 - 80
Rump steak (3 cm thick)	3 - 4	50 - 70
Steak-cut rump (3 cm thick)	3 - 4	50 - 70
<b>Veal</b>		
Fillet, whole (approx. 800 g)	4 - 5	150 - 180
Flank (approx. 2 kg, 8 - 9 cm thick)	6 - 7	360 - 420
Centre-cut rump (approx. 1.5 kg, 4 - 5 cm thick)	6 - 7	240 - 300
Medallions (4 cm thick)	3 - 4	70 - 90
<b>Lamb</b>		
Loin, boned (approx. 200 g)	2 - 3	30 - 40
Leg, boned, tied (approx. 1 kg)	6 - 7	240 - 300
<b>Poultry</b>		
Chicken breast (150 - 200 g)*	4 - 5	90 - 120
Duck breast (300 - 400 g)**	10 - 12**	70 - 90**
Turkey breast (1 kg)*	4 - 5	150 - 180
Turkey steaks (2 - 3 cm)*	3 - 4	40 - 60

\* well-done

\*\* see the note below

## Tips and tricks

Meat cooked at a low temperature cools down too quickly	Serve on warmed plates with a very hot sauce
Keeping meat cooked at a low temperature warm	Switch on  Top/bottom heat and set the temperature to 60 °C. Small pieces of meat can be kept warm for up to 45 minutes and large pieces for up to 2 hours

# Defrost

In this section, you can read about

- how to defrost using  CircoTherm®
- how to use Defrost

## Defrosting with CircoTherm®

Use  CircoTherm® to defrost and cook frozen products.

### Notes

- Frozen products that have been defrosted (meat in particular) require shorter cooking times than fresh products
- The cooking time for frozen meat increases by the defrosting time
- Always defrost frozen poultry before cooking so that you can remove the giblets
- Cook frozen fish at the same temperatures as fresh fish
- You can place large quantities of ready made frozen vegetables in aluminium dishes in the cooking compartment at the same time
- Use shelf height 1 when defrosting on one level, and shelf heights 1 + 3 when using two levels
- Observe the instructions on the packaging when using frozen foods.

Frozen meals	Temperature in °C	Defrosting time in minutes
Raw frozen products/ foods	50	30 - 90
Bread/Bread rolls (750 - 1,500 g)	50	30 - 60
Dry, frozen tray bakes	60	45 - 60
Moist, frozen tray bakes	50	50 - 70

## Defrost

You can Defrost to defrost delicate pastries particularly well (e.g. cream cakes).

1. Switch on  CircoTherm® operating mode.
2. Using the temperature selector, turn the default temperature down to 40 °C. Then turn the temperature selector one notch further anti-clockwise.  
Defrost is now set. — — — appears in the temperature display.
3. Defrost frozen food for 25 - 45 minutes, depending on type and size.
4. Remove the frozen food from the cooking compartment and let it thaw for 30 - 45 minutes.



With small quantities (pieces), the defrosting time is shortened to 15 - 20 minutes and the extended defrosting time is shortened to 10 - 15 minutes.

**Note:** To return to the  CircoTherm® operating mode, turn the temperature selector clockwise. The temperature set for CircoTherm® appears again in the temperature display.

# Yoghurt

You can also use the appliance to make home-made yoghurt: The heat of the  cooking compartment light is used for this.

1. Remove accessories and hook-in racks, telescopic shelves or separate fitting systems.
2. Heat 1 litre of long-life milk (3.5 % fat) or fresh pasteurised milk to 40 °C  
or  
Bring 1 litre of fresh milk to the boil once and allow to cool down to 40 °C.
3. Add 150 g of set yoghurt to the warm milk, stir in and fill the jars or bowls evenly. Do not pour more than 200 ml into any single container.

4. Cover the filled containers with a suitable lid or cling film.
5. Preheat the oven at 100 °C for 15 minutes using the full-surface grill.
6. Then set the operating mode selector to the  cooking compartment light.
7. Evenly space the containers over the cooking compartment floor, then close the appliance door.
8. After 8 hours, switch off the  cooking compartment light and place the containers in the refrigerator for at least 12 hours.

# Cleaning and care

In this section, you will find information on

- Cleaning and care of your appliance
- Cleaning agents and aids
- Self-cleaning surfaces in the cooking compartment
- Oven cleaning 

### Risk of short circuit!

Do not use high-pressure cleaners or steam jet cleaners to clean your appliance.

### Caution!

Surface damage due to incorrect cleaning: Do not use any

- harsh or abrasive cleaning agents
- cleaning agents that contain alcohol
- abrasive cleaning aids such as steel wool or scourers.

Observe the specifications in the tables.

**Note:** Highly recommended cleaning and care products can be purchased through our after-sales service. Observe the manufacturer's instructions.



## Cleaning the appliance exterior

Appliance part/surface	Cleaning agent/aid
Stainless steel surfaces	Apply commercially available washing-up liquid with a soft, damp cloth or chamois; dry with a soft cloth. Use cleaners for matted stainless steel if very dirty.
Painted surfaces	Apply commercially available washing-up liquid with a soft, damp cloth or chamois; dry with a soft cloth.
Control panel	Apply commercially available washing-up liquid with a soft, damp cloth or chamois; dry with a soft cloth. Do not use glass cleaners or glass scrapers.
Door panels	Use a commercially available glass cleaner or washing-up liquid with a soft, damp cloth or chamois; dry with a soft cloth. The inner door panel on the appliance door has a coating which reduces the temperature and reflects the heat. The view through the appliance door is not impaired by this. When the appliance door is open, this coating can have the effect of a light-coloured film. This is part of the design and is not due to any quality defect.

## Cleaning the cooking compartment

### Caution!

Risk of damaging the surface. Do not clean the appliance while still warm, even if using oven cleaners specially intended for this purpose.

### Notes

- Enamel is baked on at very high temperatures during manufacture. This can cause some slight colour variation. This is normal and does not affect its function.
- The edges of thin trays cannot be completely enamelled. As a result, these edges may be rough. Anti-corrosion protection is still guaranteed, however.

Appliance part	Cleaning agent/aid
Enamel surfaces (smooth surface)	To facilitate cleaning, you can switch on the interior lighting and detach the appliance door if necessary. Apply commercially available washing-up liquid or a vinegar solution with a soft, damp cloth or chamois; dry with a soft cloth. Soften baked-on food residues with a damp cloth and detergent. We recommend using oven cleaner if the oven is very dirty. Observe the manufacturer's instructions when cleaning with an oven cleaner. Leave the cooking compartment open to dry after cleaning.
Self-cleaning surfaces (rough surface)	Please see the notes in section: Self-cleaning surfaces
Door seal	Hot soapy water
Hook-in racks	Hot soapy water: Soak and clean with a dish cloth or brush.
Telescopic shelves	Hot soapy water: Clean with a dish cloth or a brush. Do not remove the lubricant while the pull-out rails are pulled out – it is best to clean them when they are pushed in. Do not soak or clean in the dishwasher.
Accessories	Soak in hot soapy water, clean with a brush and sponge or wash in the dishwasher.

## Keeping the appliance clean

To avoid getting the cooking compartment dirty,

- clean the cooking compartment after each use, as dirt will bake on the next time it is heated up, and this can only be removed with difficulty
- always remove flecks of limescale, grease, starch and albumin (e.g. egg white) immediately
- use  CircoTherm® whenever possible. This operating mode creates less dirt
- Use the universal pan to bake very moist cakes
- use suitable ovenware when roasting (e.g. roasting dish) or a roasting sheet (see section: Accessories)

## Self-cleaning surfaces

The back wall, side walls and ceiling of the cooking compartment are coated with a highly porous ceramic layer. This coating absorbs and disintegrates splashes from baking and roasting while the oven is in operation.

The higher the set temperature and the longer the oven is in operation, the better the cleaning result. Large splashes only disappear after the oven has been used several times. Residues can be removed with water and a soft sponge.

Colour variations on the self-cleaning surfaces have no effect on the self-cleaning function.

### Caution!

- Damage to surfaces on self-cleaning areas due to applying oven cleaner. Never clean the self-cleaning surfaces with oven cleaner.

If oven cleaner accidentally gets onto self-cleaning surfaces, remove it immediately with a sponge and plenty of water.

- Damage to surfaces on self-cleaning areas due to the use of abrasive and acidic cleaning agents and aids.

Do not use cleaning agents containing abrasive substances or acids.

Do not use abrasive cleaning aids such as steel wool or scourers.

## Oven cleaning

The back wall, ceiling and side walls of the cooking compartment are coated with a highly porous ceramic layer. This coating absorbs and disintegrates splashes from baking and roasting while the oven is in operation.

If these self-cleaning surfaces (rough surfaces) in the oven no longer clean themselves adequately, they can be regenerated using the  Oven cleaning operating mode.

### Risk of burns!

The appliance becomes very hot during Oven cleaning. Keep children away from the appliance.

### Preparing for oven cleaning

1. Remove accessories and hook-in racks, telescopic shelves or separate fitting systems from the cooking compartment.
2. Clean the enamel surfaces (smooth surfaces) to avoid any lasting stains (see section: Cleaning and care).

### Starting oven cleaning

1. Set the operating mode selector to  Oven cleaning.
2. Turn the temperature selector to set the desired cleaning setting.

### Main oven

Cleaning setting	Temperature display	Clock display (cooking time in hours)
low	1	0:45
medium	2	1:00
intensive	3	1:15

Your setting is automatically accepted after 10 seconds and Oven cleaning starts.  and the selected operating time setting light up on the clock display. The operating time cannot be changed.

You can activate the preselection mode in the 10 seconds before Oven cleaning starts.

When the Oven cleaning has finished, a signal sounds, **0:00** appears on the clock display and the  symbol flashes.

### Top oven



Cleaning setting	Temperature display	Oven cleaning time
low	1	45 minutes
medium	2	60 minutes
intensive	3	75 minutes

Your setting is automatically accepted after 10 seconds and Oven cleaning starts.

Once Oven cleaning is complete, a signal will sound and the cleaning setting goes out on the temperature display.

### Ending/cancelling oven cleaning

#### Main oven

1. Turn the operating mode selector back to the  position.
2. Press the  clock function button.

The appliance is switched off.

#### Top oven

Turn the operating mode selector back to the  position.

The appliance is switched off.

## Removing and fitting the appliance door

You can remove the appliance door to clean it more thoroughly.

### Risk of injury!

The hinges of the appliance door may snap shut with great force. Always open the hinge locking lever fully when removing the appliance door and close it fully after refitting. Do not reach into the hinge.

### Risk of injury!

If the appliance door has only been unhinged on one side, do not reach into the hinge. The hinge can snap back with great force. Call the after-sales service.

### Removing the appliance door

1. Open the appliance door fully.
2. Open the locking levers on the left and right-hand side fully.

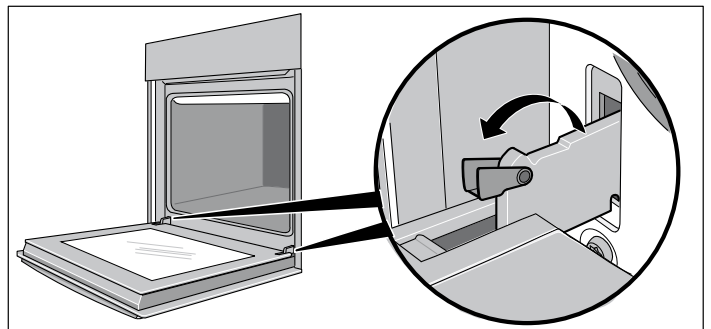

The hinges are secured and cannot snap closed.

3. Close the appliance door until resistance becomes noticeable (figure A)
4. With both hands, grip the door on the left and right-hand side, close the door a little more and pull it out (figure B).

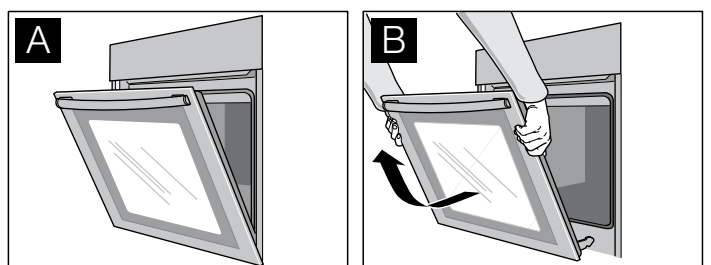

### Fitting the appliance door

1. Insert the hinges in the left and right-hand holders (figure C). The notch on both hinges must engage.
2. Open the appliance door fully.
3. Close the locking levers on the left and right-hand side fully (figure D).

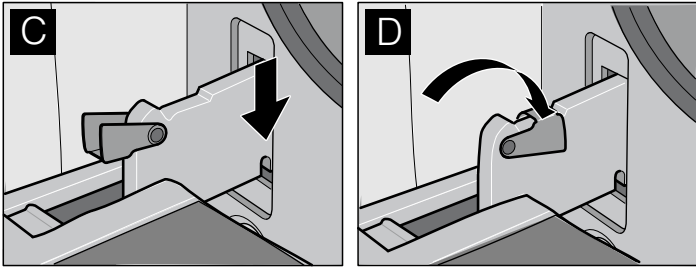

The appliance door is secured and can no longer be removed.

4. Close the appliance door.

### Cleaning the door panels

To facilitate cleaning, you can remove the inner door panels from the appliance door.

#### ⚠ Risk of injury!

The components inside the appliance door may have sharp edges. Take care not to cut yourself. Wear protective gloves.

#### ⚠ Risk of injury!

The appliance must not be used again until the door panels and appliance door have been correctly fitted.

### Removing the door panel

**Note:** Before removing, make a note of which way round the door panel is fitted, so that it is not refitted the wrong way round.

1. Unhook the appliance door and lay it on a soft, clean surface with the front side facing downwards (see section: Removing and installing the appliance door).
2. Pull off the cover at the top of the appliance door. Press in the tabs on the left and right using your fingers (fig.A).
3. Lift the door panel slightly and pull it out (Fig. B).

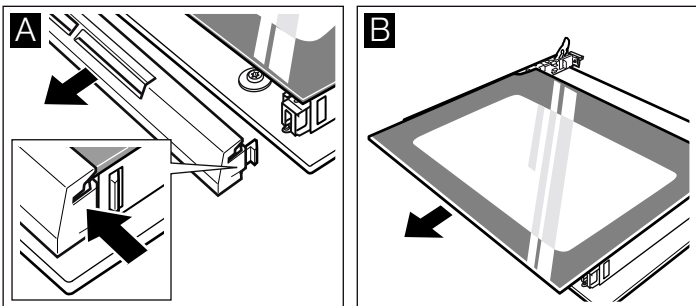

### Removing the intermediate panel

Lift the intermediate panel slightly and pull it out towards you.

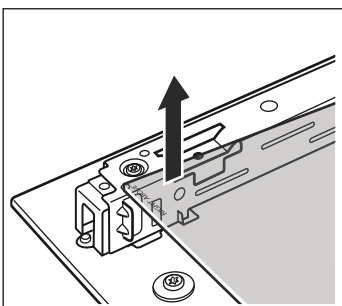

### Cleaning

Clean the door panel with glass cleaner and a soft cloth.

#### ⚠ Risk of injury!

Scratched glass in the appliance door may develop into a crack. Do not use a glass scraper, sharp or abrasive cleaning aids or detergents.

### Fitting the intermediate panel

**Note:** During installation, make sure that the lettering "top right" is upside down at the bottom left.

Insert the intermediate panel towards the back as far as it will go.

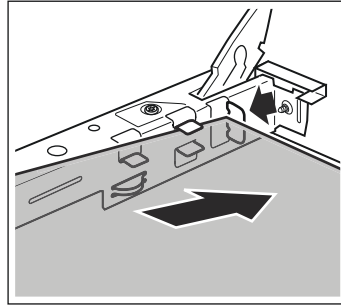

### Fitting the door panel

1. Insert the door panel at an angle towards the back into both brackets as far as it will go. The smooth surface must face outwards.

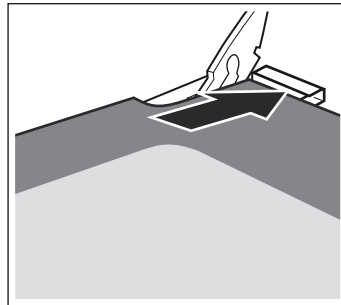

2. Put the cover back in place and press on it until it clicks in place.
3. Refit the appliance door.

### Cleaning the hook-in racks

You can remove the hook-in racks for easier cleaning.

#### ⚠ Risk of burning due to hot components in the cooking compartment!

Wait until the cooking compartment has cooled down.

1. Push the hook-in rack upwards at the front and unhook to the side (figure A).
2. Pull the hook-in rack forwards at the rear and unhook to the side (figure B).

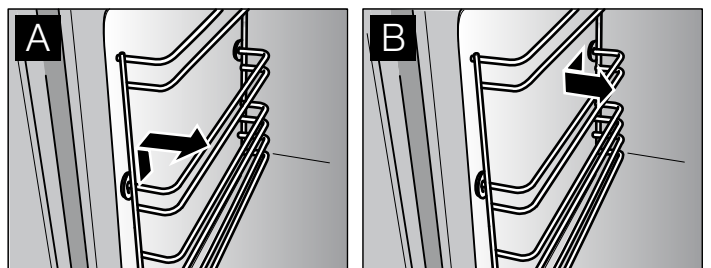

3. Clean the hook-in rack with washing-up liquid and a sponge or brush.
4. Align the hook-in rack with the indentation (a) facing downwards, so that the shelf heights match.
5. Insert the hook-in rack at the rear as far as it will go and push to the rear (figure C).
6. Insert the hook-in rack at the front as far as it will go and push downwards (figure D).

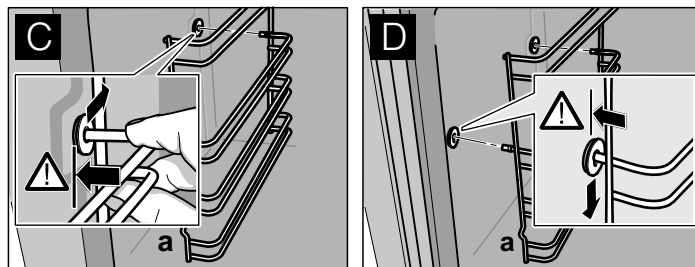

## Faults and repairs

It is not always necessary to call the after-sales service. Sometimes, you can find a remedy yourself. You will find some tips for troubleshooting in the following table.

### Risk of electric shock!

- Work on the appliance electronics may only be performed by a specialist.
- Always disconnect the appliance from the power supply when work is carried out on the electronics. Switch off the circuit breaker or remove the fuse from your household fuse box.

Problem	Possible cause	Remedial action
Electrical function is faulty (e.g. indicator lamps do not light up)	Fuse defective	Check fuses in the fuse box and replace if necessary
Liquid or runny dough runs to one side	Appliance not installed level	Check the appliance installation (see the Installation instructions)
Appliance no longer works, 0:00 flashes in the clock display	There was a power cut	Reset the time of day (see section: Electronic clock)
0:00 flashes in the clock display, "rrr" appears in the temperature display	The power supply was interrupted while the appliance was in operation	Press the ◀▶ clock function button. Reset the time of day (see section: Electronic clock)
"E011" appears in the temperature display	Permanent assignment of a button	Cancel the permanent assignment of the button and press the ◀▶ clock function button
The temperature display shows, "EXXX", e.g. E300	Internal fault in the appliance electronics	Press the ◀▶ clock function button. If the message does not go out, pull out the mains plug and plug it back in again after approx. 10 seconds
Appliance operation is not possible, ☞ and -S- appear in the temperature display	The appliance has been locked	Deactivate the lock (see section: Childproof lock)
Appliance operation is not possible, ☞ and -SP appear in the temperature display	The appliance controls were automatically blocked	Deactivate the permanent lock (see section: Childproof lock)
The appliance does not heat up, the two dots flash in the clock display, and 150o appears in the temperature display, for example	A button combination was actuated	Switch off the appliance, press and hold the i info button for 3 seconds, then press and hold the ◀▶ clock function button for 4 seconds, then press and hold the i info button again for 3 seconds
Electronically controlled functions are malfunctioning	Energy surges (e.g. lightning strike)	Reset the function concerned
When an operating mode is switched on, H or h appears in the temperature display	The appliance has not cooled down fully	Wait until the appliance has cooled down, then switch on the operating mode again
The appliance has switched off automatically, 000 flashes in the temperature display	The appliance has switched off to protect itself from overheating	Turn the operating mode selector back to the 0 position
Smoke is generated during roasting or grilling	Fat is burning on the grill element	Continue grilling or roasting until the fat on the grill element is burnt away
	Wire rack or universal pan inserted incorrectly	Check the shelf levels (see section: Roasting or grilling)
Higher levels of condensation are generated in the cooking compartment	Normal occurrence (e.g. when baking cakes with very moist toppings or roasting a large joint)	Open the appliance door briefly from time to time during operation

Problem	Possible cause	Remedial action
Enamelled accessories have matt, light-coloured marks	Normal occurrence caused by dripping meat or fruit juices	Not possible
Door panels are misted up	Normal occurrence caused by temperature differences	Heat the appliance up to 100 °C and then switch off again after 5 minutes

## Replacing the oven light bulb

Replace faulty oven light bulbs.

Spare bulbs can be obtained from the after-sales service or specialist retailers. Only use these oven light bulbs.

- For the main oven: E14, 220 - 240 V, 40 W, heat-resistant to 300 °C.
- For the top oven: E14, 220 - 240 V, 25 W, heat-resistant to 300 °C.

### Risk of electric shock !

Disconnect the appliance from the power supply. Switch off the circuit breaker or remove the fuse from the household fuse box.

1. Place a tea towel in the cold cooking compartment to prevent damage.
2. Turn the glass cover anticlockwise and remove it.

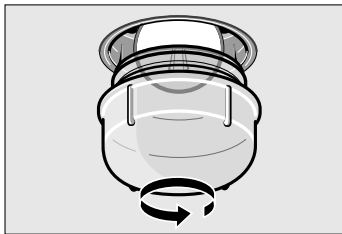

3. Replace the oven light bulb with a bulb of the same type.
4. Screw on the glass cover again.
5. Remove the tea towel and switch on the circuit breaker.

**Note:** Use rubber gloves if the glass cover cannot be unscrewed: Or order a special removal tool from the after-sales service:

- For the main oven: Order no. 613634
- For the top oven: Order no. 621743

## Changing the door seal

If the door seal is defective, it must be replaced. Replacement seals for your appliance can be obtained from the after-sales service.

The door seal is attached in four places (figure A). When replacing it, disconnect and attach the hooks at all four points (figure B).

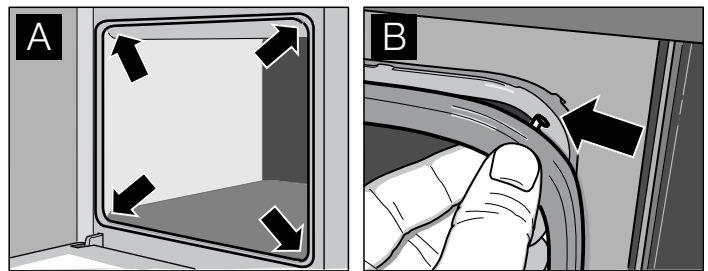

Check again to ensure that the seal is seated correctly in the corners in particular.

## After-sales service

Our after-sales service is there for you if your appliance needs to be repaired. We will always find the right solution in order to avoid unnecessary visits from a service technician.

### E number and FD number

When calling us, please give the product number (E no.) and the production number (FD no.) so that we can provide you with the correct advice. The rating plate containing these numbers can be found on the right-hand side of the oven door. You can make a note of the numbers of your appliance and the telephone number of the after-sales service in the space below to save time should it be required.

**E no.** \_\_\_\_\_ **FD no.** \_\_\_\_\_

**After-sales service** 

Please find the contact data of all countries in the enclosed customer service list.

### To book an engineer visit and product advice

**GB** 0344 892 8989

Calls charged at local or mobile rate.

**IE** 01450 2655

0.03 € per minute at peak. Off peak 0.0088 € per minute.

Rely on the professionalism of the manufacturer. You can therefore be sure that the repair is carried out by trained service technicians who carry original spare parts for your appliances.

Please note that there will be a fee for a visit by a service technician in the event of a malfunction, even during the warranty period.

# Test dishes

These tables have been produced for test institutes to facilitate the inspection and testing of the various appliances.

Test dishes tested to standard EN 50304/EN 60350 (2009) and IEC 60350.

Please note the information in the tables about preheating. The table values do not include Rapid heat up.

**Note:** For baking, use the lower of the temperatures indicated first.

Baking	Cookware	Oven	Setting	Level	Temperature	Time in minutes
Shortbread	Baking tray***			3	140 - 150**	25 - 35
	Baking tray***			1	140 - 150**	25 - 35
	Baking tray***			1	160 - 170	20 - 35
	2 baking trays***			1 + 3	140 - 150**	30 - 40
	3 baking trays***			1 + 3 + 4	130 - 140**	40 - 50
Small cakes (x 20)	Baking tray***			3	160 - 170*	25 - 30
	Baking tray***			1	150 - 160*	25 - 35
	Baking tray***			1	170 - 180	25 - 40
	2 baking trays***			1 + 3	140 - 150*	30 - 40
	3 baking trays***			1 + 3 + 4	140 - 150*	35 - 50
Fat-free sponge cake	Springform cake tin**** dia. 26 cm			2	160 - 170**	25 - 35
	Springform cake tin**** dia. 26 cm			1	160 - 170**	25 - 35
Apple pie	2 x Springform cake tin**** dia. 20 cm (see figure A)			1	170 - 180**	70 - 80
	2 x Springform cake tin**** dia. 20 cm (see figure A)			1	190 - 200	80 - 90
	2 x Springform cake tin**** dia. 20 cm			1	170 - 180**	60 - 70
	2 x Springform cake tin**** dia. 20 cm (see figure B)			1 + 3	170 - 180**	65 - 75

\* Preheat for 10 minutes

\*\* Preheat oven

\*\*\* Only use original baking trays, order no. Z1342X0

\*\*\*\* Use a black Springform cake tin

When baking apple pie using CircoTherm®, place both springform cake tins next to each other on the wire rack (figure A).

If you are baking German apple pie on two levels, place the lower baking tin to the left on the wire rack and the upper baking tin to the right on the wire rack (figure B),

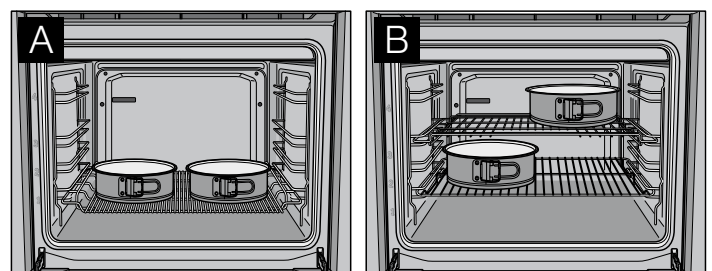

Grilling	Cookware	Oven	Setting	Level	Temperature	Time in minutes
White bread	Universal pan + wire rack			3 + 4	int*	0.5 - 2
	Universal pan + wire rack			1 + 2	int*	0.5 - 2
Beef steaks	Universal pan + wire rack			3 + 4	250	20 - 25**
	Universal pan + wire rack			1 + 2	250	25 - 30**

\* Preheat for 10 minutes

\*\* Turn after 2/3 of the time



Constructa-Neff  
Vertriebs-GmbH  
Carl-Wery-Straße 34  
D-81739 München  
GERMANY

Register your product online

[www.neff-international.com](http://www.neff-international.com)



9001135398

950723