



Built-in oven

[en] Instruction manual

B14P42.5GB



en Table of contents

Important safety information	3	Baking table for ready-made products.....	15
Causes of damage.....	5	Tips and tricks.....	16
Energy and environment tips	5	Roasting and braising	16
Saving energy.....	5	Roasting.....	16
Environmentally-friendly disposal.....	5	Braising.....	17
Your new oven	6	Tables for roasting and braising.....	17
Control panel.....	6	Tips and tricks.....	18
Operating modes.....	6	Grilling	18
Cooking compartment.....	7	Circo-roasting.....	19
Your accessories	7	Radiant grilling.....	19
Accessories.....	7	Defrosting	20
Inserting accessories.....	7	Defrosting with CircoTherm®.....	20
Shelf positions.....	7	Defrost.....	20
Optional accessories.....	7	Preserve	21
Before using the appliance for the first time	8	Pyrolytic cleaning	22
Setting the clock.....	8	Important notes.....	22
Cleaning the appliance.....	8	Before cleaning.....	22
Operating the appliance	8	Setting the cleaning level.....	22
Switching on the appliance.....	8	After cleaning.....	23
Switching off the appliance.....	9	Care and cleaning	23
Changing the basic settings.....	9	Cleaning agents.....	23
Automatic safety cut-out.....	9	Cleaning the hook-in racks.....	23
Electronic clock	10	Detaching and attaching the oven door.....	24
Clock display.....	10	Removing the door cover.....	24
Timer.....	10	Removing and installing the door panels.....	24
Cooking time.....	11	Faults and repairs	26
End of operation.....	11	Malfunction table.....	26
Preset operation.....	11	Replacing the bulb in the oven ceiling light.....	27
Setting the clock.....	11	Glass cover.....	27
Rapid heat up.....	12	After-sales service	27
Checking, correcting or deleting settings.....	12	E number and FD number.....	27
Childproof lock	12	Test dishes	28
Lock.....	12		
Permanent lock.....	12		
Baking	13		
Baking on one level.....	13		
Baking on two or more levels.....	13		
Baking table.....	14		

Additional information on products, accessories, replacement parts and services can be found at www.neff-international.com and in the online shop www.neff-eshop.com

Important safety information

Read these instructions carefully. Only then will you be able to operate your appliance safely and correctly. Retain the instruction manual and installation instructions for future use or for subsequent owners.

This appliance is only intended to be fully fitted in a kitchen. Observe the special installation instructions.

Check the appliance for damage after unpacking it. Do not connect the appliance if it has been damaged in transport.

Only a licensed professional may connect appliances without plugs. Damage caused by incorrect connection is not covered under warranty.

This appliance is intended for domestic use only. The appliance must only be used for the preparation of food and drink. The appliance must be supervised during operation. Only use this appliance indoors.

This appliance is intended for use up to a maximum height of 2000 metres above sea level.

This appliance may be used by children over the age of 8 years old and by persons with reduced physical, sensory or mental capabilities or by persons with a lack of experience or knowledge if they are supervised or are instructed by a person responsible for their safety how to use the appliance safely and have understood the associated hazards.

Children must not play with, on, or around the appliance. Children must not clean the appliance or carry out general maintenance unless they are at least 8 years old and are being supervised.

Keep children below the age of 8 years old at a safe distance from the appliance and power cable.

Always slide accessories into the cooking compartment correctly. See "*Description of accessories*" in the instruction manual.

Risk of fire!

- Combustible items stored in the cooking compartment may catch fire. Never store combustible items in the cooking compartment. Never open the appliance door if there is smoke inside. Switch off the appliance and unplug it from the mains or switch off the circuit breaker in the fuse box.
- A draught is created when the appliance door is opened. Greaseproof paper may come into contact with the heating element and catch fire. Do not place greaseproof paper loosely over accessories during preheating. Always weight down the greaseproof paper with a dish or a baking tin. Only cover the surface required with greaseproof paper. Greaseproof paper must not protrude over the accessories.

Risk of burns!

- The appliance becomes very hot. Never touch the interior surfaces of the cooking compartment or the heating elements. Always allow the appliance to cool down. Keep children at a safe distance.
- Accessories and ovenware become very hot. Always use oven gloves to remove accessories or ovenware from the cooking compartment.
- Alcoholic vapours may catch fire in the hot cooking compartment. Never prepare food containing large quantities of drinks with a high alcohol content. Only use small quantities of drinks with a high alcohol

content. Open the appliance door with care.

Risk of scalding!

- The accessible parts become hot during operation. Never touch the hot parts. Keep children at a safe distance.
- When you open the appliance door, hot steam may escape. Open the appliance door with care. Keep children at a safe distance.
- Water in a hot cooking compartment may create hot steam. Never pour water into the hot cooking compartment.

Risk of injury!

Scratched glass in the appliance door may develop into a crack. Do not use a glass scraper, sharp or abrasive cleaning aids or detergents.

Risk of electric shock!

- Incorrect repairs are dangerous. Repairs may only be carried out by one of our trained after-sales engineers. If the appliance is faulty, unplug the mains plug or switch off the fuse in the fuse box. Contact the after-sales service.
- The cable insulation on electrical appliances may melt when touching hot parts of the appliance. Never bring electrical appliance cables into contact with hot parts of the appliance.
- Do not use any high-pressure cleaners or steam cleaners, which can result in an electric shock.
- When replacing the cooking compartment bulb, the bulb socket contacts are live. Before replacing the bulb, unplug the appliance from the mains or switch off the circuit breaker in the fuse box.
- A defective appliance may cause electric shock. Never switch on a defective appliance. Unplug the appliance from the mains or switch off the circuit breaker in the fuse box. Contact the after-sales service.

Risk of fire!

- Loose food residues, grease and meat juices may catch fire during the Self-cleaning cycle. Remove coarse dirt from the cooking compartment and from the accessories before every Self-cleaning cycle.

- The appliance will become very hot on the outside during the Self-cleaning cycle. Never hang combustible objects, e.g. tea towels, on the door handle. Do not place anything against the front of the oven. Keep children at a safe distance.

Risk of burns!

- The cooking compartment will become very hot during the Self-cleaning cycle. Never open the appliance door or move the locking latch by hand. Allow the appliance to cool down. Keep children at a safe distance.
-  The appliance will become very hot on the outside during the Self-cleaning cycle. Never touch the appliance door. Allow the appliance to cool down. Keep children at a safe distance.

Risk of serious damage to health!

The appliance will become very hot during the Self-cleaning cycle. The non-stick coating on baking trays and tins is destroyed and noxious gases are released. Never let non-stick baking trays and tins go through the Self-cleaning cycle. Only enamelled accessories may be cleaned at the same time.

Causes of damage

Caution!

- Accessories, foil, greaseproof paper or ovenware on the cooking compartment floor: do not place accessories on the cooking compartment floor. Do not cover the cooking compartment floor with any sort of foil or greaseproof paper. Do not place ovenware on the cooking compartment floor if a temperature of over 50 °C has been set. This will cause heat to accumulate. The baking and roasting times will no longer be correct and the enamel will be damaged.
- Water in a hot cooking compartment: do not pour water into the cooking compartment when it is hot. This will cause steam. The temperature change can cause damage to the enamel.
- Moist food: do not store moist food in the cooking compartment when it is closed for prolonged periods This will damage the enamel.
- Fruit juice: when baking particularly juicy fruit pies, do not pack the baking tray too generously. Fruit juice dripping from the baking tray leaves stains that cannot be removed. If possible, use the deeper universal pan.
- Cooling with the appliance door open: only allow the cooking compartment to cool when it is closed. Even if the appliance door is only open a little, front panels of adjacent units could be damaged over time.
- Very dirty door seal: If the door seal is very dirty, the appliance door will no longer close properly when the appliance is in use. The fronts of adjacent units could be damaged. Always keep the door seal clean.
- Appliance door as a seat, shelf or worktop: Do not sit on the appliance door, or place or hang anything on it. Do not place any cookware or accessories on the appliance door.
- Inserting accessories: depending on the appliance model, accessories can scratch the door panel when closing the appliance door. Always insert the accessories into the cooking compartment as far as they will go.
- Carrying the appliance: do not carry or hold the appliance by the door handle. The door handle cannot support the weight of the appliance and could break.

Energy and environment tips

Here you can find tips on how to save energy when baking and roasting and how to dispose of your appliance properly.

Saving energy

- Only preheat the oven if this is specified in the recipe or in the operating instruction tables.
- Use dark, black lacquered or enamelled baking tins. They absorb the heat particularly well.
- Open the oven door as infrequently as possible while you are cooking, baking or roasting.
- It is best to bake several cakes one after the other. The oven is still warm. This reduces the baking time for the second cake. You can also place two loaf tins next to each other.
- For longer cooking times, you can switch the oven off 10 minutes before the end of the cooking time and use the residual heat to finish cooking.

Environmentally-friendly disposal

Dispose of packaging in an environmentally-friendly manner.



This appliance is labelled in accordance with European Directive 2012/19/EU concerning used electrical and electronic appliances (waste electrical and electronic equipment - WEEE). The guideline determines the framework for the return and recycling of used appliances as applicable throughout the EU.

Your new oven

In this section, you will find information on

- the control panel

- the operating modes
- the cooking compartment

Control panel

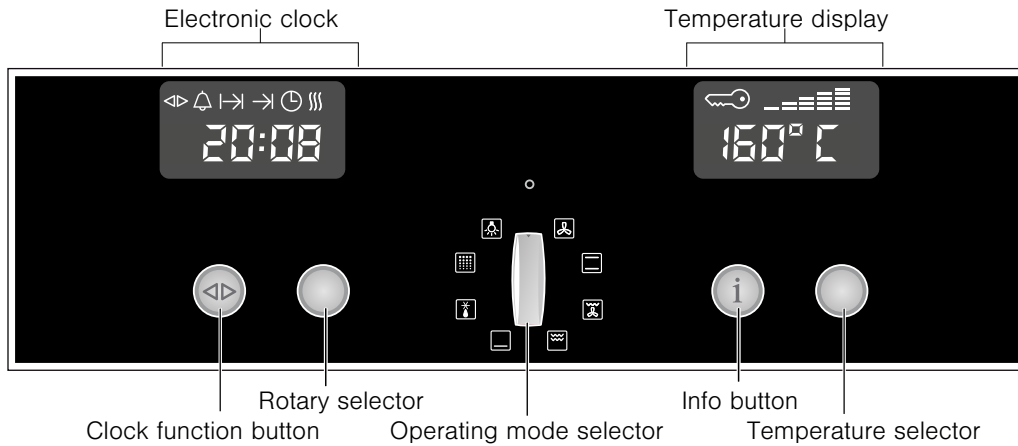

Control element	Use
◀▶	Clock function button Selects the required clock function or Rapid heat up (see section: Electronic clock)
	Rotary selector Makes settings within a clock function or activates Rapid heat up (see section: Electronic clock)
	Operating mode selector Selects the desired operating mode (see section: Switching on the appliance)
i	Info button When the appliance is switched on: displays the current oven temperature during the heating up phase (see section: Switching on the appliance) When the appliance is switched off: calls up the basic settings menu (see section: Changing the basic settings)
	Temperature selector When the appliance is switched on: sets the temperature (see section: Switching on the appliance) When the appliance is switched off: changes the settings in the basic settings menu (see section: Changing the basic settings)

Pop-out operating knob

The rotary, temperature and operating mode selectors can all be popped out. Push the required operating knob to pop it in or out.

Operating modes

Here you can obtain an overview of your appliance's operating modes.

Operating mode	Application
🔥 CircoTherm®*	For baking and roasting on one or more levels
☐ Top/bottom heat	For baking and roasting on one level. Ideal for cakes with moist toppings (e.g. cheese-cake)
🔥🔥 Circo-roasting	For poultry and larger pieces of meat
☐ Radiant grilling	For a large number of flat, small items for grilling (e.g. steaks, bread)
☐ Bottom heat	For food and baked items on which you want a crust to form, or which need more browning on the underside. Only activate Bottom heat for a short while at the end of the baking time.
🔥 Defrost	For gently defrosting pieces of meat, bread and delicate pastries (e.g. cream gateau)
☐ Pyrolytic cleaning	For automatic cleaning of the cooking compartment. The oven heats up until the dirt disintegrates.
☐ Interior lighting	Helps with the care and cleaning of the cooking compartment

* Operating mode used to determine the energy efficiency class in accordance with EN50304.

Cooking compartment

The oven light is located in the cooking compartment. A cooling fan protects the oven from overheating.

Oven light

During operation, the oven light in the cooking compartment is on. The  setting on the function selector can be used to switch on the light without heating the oven.

Cooling fan

The cooling fan switches on and off as required. The hot air escapes above the door. Caution: do not cover the ventilation slots. Otherwise the oven will overheat.

So that the cooking compartment cools down more quickly after operation, the cooling fan continues to run for a certain period afterwards.

Your accessories

In this section, you will find information on

- Your accessories
- the correct way to insert the accessories into the cooking compartment
- the shelf positions
- the optional accessories

Accessories

The following accessories are included with your appliance:



Wire rack
for baking in baking tins, roasting in roasting dishes and grilling

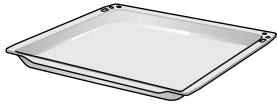

Universal pan, enamelled
for baking moist cakes, roasting, grilling and collecting drops of liquid during cooking

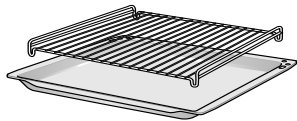

Insert grid
for roasting and grilling

Note: The wire insert is always used together with the universal pan. In this combination, the wire insert is placed in the universal pan.

Note: The baking tray and universal pan may become distorted when the appliance is in operation. This is caused by the considerable temperature differences acting on the accessories. These differences may occur if only a part of the accessory is covered with food, or if frozen items such as pizza are placed on the accessory.

Inserting accessories

The accessories are equipped with a locking function. The locking function prevents the accessories from tilting when they are pulled out. The accessories must be inserted into the cooking compartment correctly for the tilt protection to work properly.

When inserting the wire rack, check

- that the lug (a) is pointing downwards
- that the lug (a) is in the rear part of the wire rack

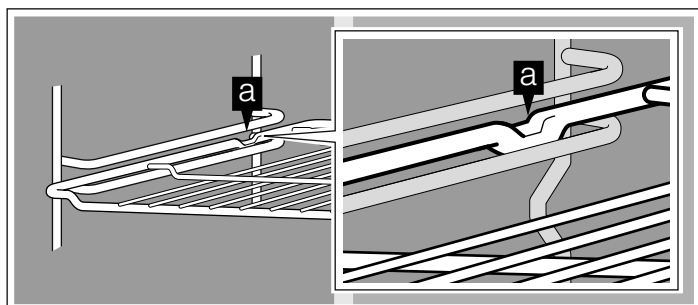

When inserting the baking tray or the universal pan, check

- that the lug (a) is in the rear part of the of the accessory
- that the sloping edge of the accessory faces towards the appliance door when it is inserted

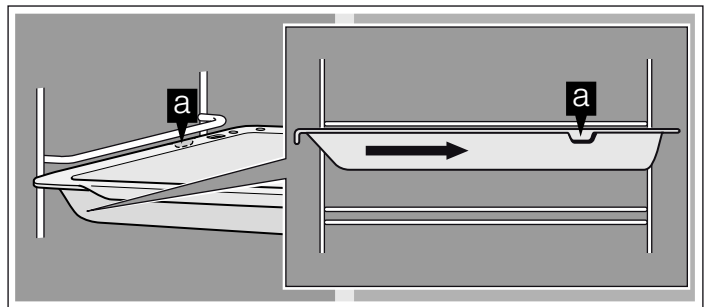

Shelf positions

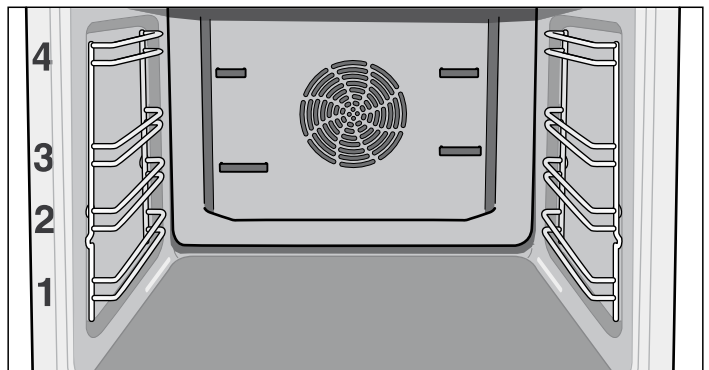

The cooking compartment has four shelf heights. The shelf heights are counted from the bottom up.

Note: Do not use shelf height 2 when baking and roasting with  CircoTherm®. This will adversely affect air circulation and your baking and roasting results will not be as good.

Optional accessories

You can purchase optional accessories from the after-sales service or specialist retailers. You will find a comprehensive range of products for your appliance in our brochures and on our website.

The availability of special accessories and whether it is possible to order them online may vary depending on your country. Please see the sales brochures for more details.

Not all optional accessories are suitable for every appliance. When purchasing, please always quote the exact designation (E-no.) of your appliance.

Optional accessories	Order no.
Mega system steamer	N8642X3
Universal pan, enamelled	Z1232X3
Universal pan, non-stick	Z1233X3
Universal pan with wire insert	Z1242X3

Optional accessories	Order no.
Extra-deep pan, enamelled	Z1272X0
Baking tray, aluminium	Z1332X0
Baking tray, enamelled	Z1342X0
Baking tray, non-stick	Z1343X0
Pizza tray	Z1352X0
Baking and roasting shelf	Z1432X3
Roasting tray, enamelled, two-piece	Z1512X0
CLOU® 1x telescopic shelf	Z1701X2
CLOU® 2x telescopic shelf	Z1765X2
CLOU® 3x telescopic shelf	Z1742X2
CLOU® 3x telescopic shelf with full extension	Z1745X2
CLOU® 4x telescopic shelf with full extension	Z1755X2
VarioCLOU® telescopic shelf with full extension	Z1785X3
Bread-baking stone	Z1913X0

Before using the appliance for the first time



In this section, you can read about

- How to set the clock after connecting up your appliance
- How to clean your appliance before using it for the first time



Setting the clock

Note: When you press the  clock function button, you have 3 seconds to set the clock using the rotary selector. Should this have been insufficient for you, you can amend the clock time later.

0:00 flashes in the clock display.

1. Briefly press the  clock function button to go to the setting mode.
The  and  symbols light up. **12:00** appears in the clock display.
2. Set the current time using the rotary selector.
Your setting is accepted after 3 seconds.

Changing the clock

To subsequently change the time, press the  clock function button repeatedly until the  and  symbols light up again. Change the time with the rotary selector.



Cleaning the appliance

Clean your appliance before using it for the first time.

1. Remove accessories and any remaining packaging from the cooking compartment.
2. Clean the accessories and cooking compartment with hot soapy water (see section: Cleaning and care).
3. Heat with  Top/bottom heat at 240°C for 60 minutes.
4. Afterwards, wipe the cooled cooking compartment with hot, soapy water.
5. Clean the outside of the appliance with a soft, damp cloth and soapy water.

Operating the appliance

In this section, you can read about

- how to switch your appliance on and off
- how to select an operating mode and temperature

Switching on the appliance

1. Turn the operating mode selector until the desired operating mode is selected.
A default temperature appears in the temperature display.
2. Turn the temperature selector to change the default temperature.

Note: If no default temperature is displayed, the temperature for your selected operating mode is a fixed setting. You cannot change this temperature.

Operating mode	Default temperature in °C	Temperature range in °C
CircoTherm®	160	40 - 200
Top/bottom heat	170	50 - 275
Circo-roasting	170	50 - 250
Radiant grilling*	220	50 - 275
Bottom heat	200	50 - 225
Defrost	Fixed setting	
Pyrolytic cleaning	0	1, 2 and 3
Interior lighting	Fixed setting	

* Turn the temperature selector beyond 275 °C. *in* appears in the temperature display

Current temperature

Press the **i** info button. The current temperature appears for 3 seconds.

Note: The current temperature can only be displayed with operating modes with a default temperature.

Heating indicator

The heating indicator displays the rising temperature in the cooking compartment.

- Temperature reached (figure A)
- Appliance reheating (figure B)

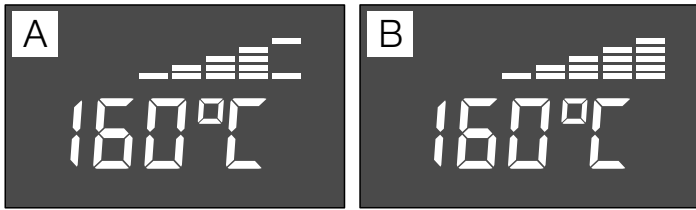

Switching off the appliance

Turn the operating mode selector to the **O** position. The appliance is switched off.

The appliance has a cooling fan. After the appliance is switched off, the cooling fan may continue to run.

You can see in the temperature display whether there is high or low residual heat in the cooking compartment.

Temperature display	Meaning
<i>H</i>	Residual heat high (above 120 °C)
<i>h</i>	Residual heat low (between 60 °C and 120 °C)

Changing the basic settings

Your appliance has various basic settings, which are preset at the factory. You can, however, change these basic settings as required.

The appliance must be switched off and controls must not be locked.

1. Press and hold the **i** info button for 3 seconds to go to the basic settings menu.
In the temperature display, *c 10* appears.
2. Press the **i** info button briefly and repeatedly until the setting symbol for the current basic setting of a submenu is displayed in the temperature display (e.g. *c 32*).
3. Using the temperature selector, set the required basic setting within a submenu (e.g. *c 33*).
4. Press and hold the **i** info button for 3 seconds.
Your basic setting is saved.

You can change the following basic settings:

Basic settings menu

Submenu	Basic setting	Setting symbol
Childproof lock	Appliance controls unlocked	<i>c 10</i>
	Appliance controls locked	<i>c 11</i>
	Appliance controls permanent lock	<i>c 21</i>
Audible signal	Audible signal off	<i>c 30</i>
	Audible signal 30 seconds	<i>c 31</i>
	Audible signal 2 minutes	<i>c 32</i>
	Audible signal 10 minutes	<i>c 33</i>

Automatic safety cut-out

The automatic safety cut-out is activated if your appliance is switched on and you have not made any settings for a long time.

The length of time after which your appliance switches itself off depends on the settings that you make.

000 flashes in the temperature display. Appliance operation is interrupted.

Turn the operating mode selector to the **O** position to deactivate it.

Electronic clock

In this section, you can read about

- how to set the timer
- how to switch your appliance off automatically (cooking time and end of operation)
- how to switch your appliance on and off automatically (preset operation)
- how to set the time
- find out how to activate rapid heat up

Clock display

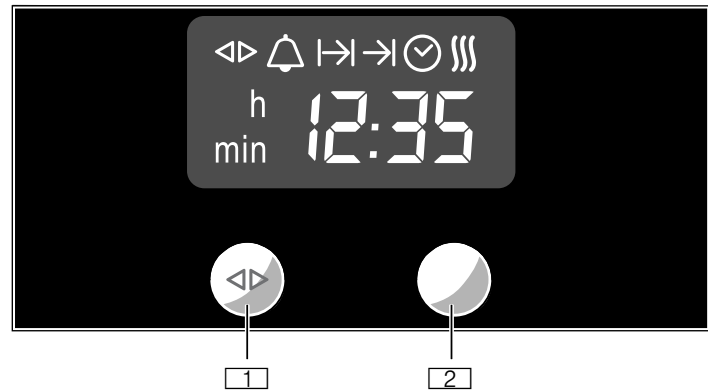

- 1 Clock function button
- 2 Rotary selector

Clock function	Use
Timer	You can use the minute minder as an egg timer or a kitchen timer. The appliance does not switch on or off automatically
Cooking time	The appliances switches off automatically after a cooking time setting has elapsed (e.g. 1:30 hours)
End of operation	The appliance switches off automatically at a set time (e.g. 12:30)
Preset operation	The appliance switches on and off automatically. Cooking time and end of operation have been combined.
Clock	Setting the clock
Rapid heat up	Shortens the heat up time

Notes

- Between the times **22:00** and **5:59** the clock display is dimmed if you do not make any settings in that period or no clock function is activated.
- When you set a clock function, the time interval increases when you set higher values (e.g. cooking time up to **1:00h** to the minute, using **1:00h** to the nearest 5 minutes).
- For the minute minder, cooking time, end of operation and preselection mode clock functions, a signal sounds when the settings have elapsed and the or symbol flashes. To cancel the audible signal before it ends, press the clock function button.
- Briefly press the clock function button to select a clock function. You then have 3 seconds to set the selected clock function. After this time, the setting mode is exited automatically.

Switching the clock display on and off

1. Press and hold the clock function button for 6 seconds.
The clock display switches off. If a clock function is active, the associated symbol remains lit.
2. Press the clock function button briefly.
The clock display switches on.

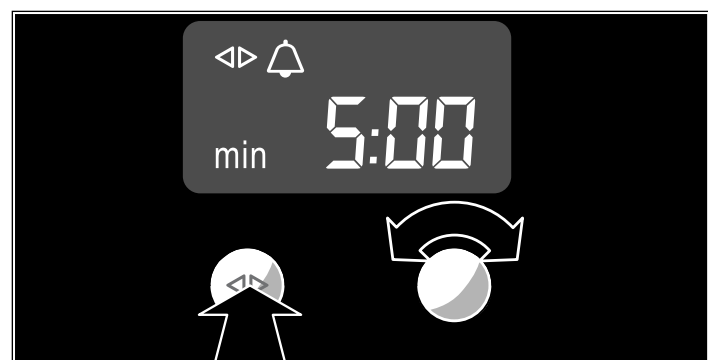

Timer

1. Press the clock function button repeatedly until the and symbols light up.
2. Set the duration using the rotary selector (e.g. **5:00** minutes).
The setting is applied automatically. Then the clock is displayed again and the minute minder starts counting down.



Cooking time

Automatic switch-off after a cooking time setting has elapsed.

1. Set the operating mode and temperature.
The appliance heats up.
2. Press the  repeatedly until the  and  symbols light up.
3. Set the cooking time with the rotary selector (e.g. **1:30** hours).
The setting is applied automatically. The time is then displayed again and the set cooking time counts down.

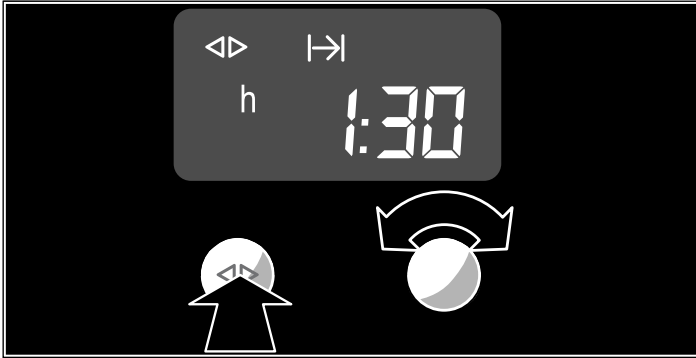



Once the cooking time has elapsed, the appliance switches off automatically.

1. Turn the operating mode and temperature selector back to the **O** position.
2. Press the  clock function button to exit the clock function.

End of operation

Automatic switch-off at a set time.

1. Set the operating mode and temperature.
The appliance heats up.
2. Press the  repeatedly until the  and  symbols light up.
3. Set the end of operation using the rotary selector (e.g. **12:30** o'clock).
The setting is applied automatically. The clock is then displayed again.









The appliance switches off automatically at the time set for the end of operation.

1. Turn the operating mode and temperature selector back to the **O** position.
2. Press the  clock function button to exit the clock function.

Preset operation



The appliance switches on automatically, then switches off automatically at the time preselected for the end of operation. To set this function, combine the cooking time and end of operation clock functions.

Bear in mind that food which spoils easily should not be left in the cooking compartment for too long.

1. Set the operating mode and temperature.
The appliance heats up.
2. Press the  repeatedly until the  and  symbols light up.
3. Set the cooking time with the rotary selector (e.g. **1:30** hours).
The setting is applied automatically.
4. Press the  repeatedly until the  and  symbols light up.
5. Set the end of operation using the rotary selector (e.g. **12:30** o'clock).
The appliance switches off and waits until the appropriate time to switch on (**11:00** in the example). The appliance switches off automatically at the time set for the end of operation (**12:30**).
6. Turn the operating mode and temperature selector back to the **O** position.
7. Press the  clock function button to exit the clock function.

Setting the clock

You can only change the clock when no other clock function is active.







1. Press the  clock function button repeatedly until the  and  symbols light up.
2. Set the clock using the rotary selector.
The setting is applied automatically.





Rapid heat up

With  CircoTherm®, you can shorten the heat up time if your selected temperature setting is higher than 100 °C.

Note: During Rapid heat up, do not place any food in the cooking compartment for as long as the  symbol is lit.

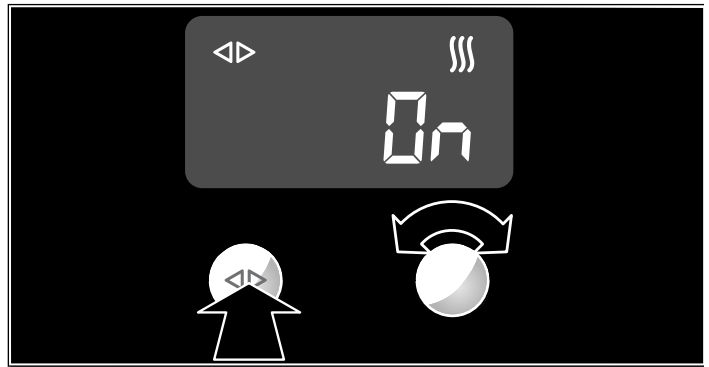
1. Set the operating mode and temperature.
The appliance heats up.
2. Press the  clock function button repeatedly until the  and  symbols light up and  appears in the clock display.
3. Turn the rotary selector clockwise.
In the clock display,  is displayed and the  symbol lights up. Rapid heat up is activated.



After reaching the set temperature, Rapid heat up switches off. The  symbol goes out.

Checking, correcting or deleting settings

1. To check your settings, press the  clock function button repeatedly until the corresponding symbol lights up.
2. If necessary, you can correct your setting using the rotary selector.
3. If you wish to cancel your setting, turn the rotary selector anti-clockwise to the original value.

Childproof lock

In this section, you will read about

- how to lock your appliance
- how to lock your appliance permanently





Note: If a hob is connected, it will not be affected by the childproof lock on the oven.

Lock

Once it has been locked, the appliance cannot be switched on accidentally or by unauthorised users (e.g. by children playing).





To switch the appliance on again, you must unlock it. After appliance operation, the appliance is not automatically locked. Lock it again if necessary or activate the permanent lock.

Lock appliance

1. Switch off the appliance.
2. Press and hold the  info button until  appears in the temperature display.
3. Turn the temperature selector until  appears on the temperature display.
4. Press and hold the  info button until the  symbol appears in the temperature display.

Note: If you try to switch the appliance on when it is locked,  appears in the temperature display.

Unlocking the appliance





1. Press and hold the  info button until  appears in the temperature display.
2. Turn the temperature selector until  appears on the temperature display.
3. Press and hold the  info button until the  symbol goes out.

Permanent lock

Once it has been permanently locked, the appliance cannot be switched on accidentally or by unauthorised users (e.g. by children playing).





To switch the appliance on, you must interrupt the permanent lock briefly. After you have switched your appliance off, it locks again automatically.

Locking the appliance permanently

1. Switch off the appliance.
2. Press and hold the  info button until  appears in the temperature display.
3. Turn the temperature selector until  appears on the temperature display.
4. Press and hold the  info button for 3 seconds.
Your appliance will be locked after 30 seconds. The  symbol appears on the temperature display.

Note: If you try to switch the locked appliance on,  appears in the temperature display.

Interrupting permanent lock

1. Press and hold the  info button until  appears in the temperature display.
2. Turn the temperature selector until  appears on the temperature display.
3. Press and hold the  info button until the  symbol goes out.
The permanent lock is interrupted.
4. Switch the appliance on within 30 seconds.
After the permanent lock is switched off, it is reactivated after 30 seconds.

Unlocking the appliance permanently

1. Press and hold the **i** info button until **c 2 i** appears in the temperature display.
2. Turn the temperature selector until **c 20** appears on the temperature display.
3. Press and hold the **i** info button until the **↔** symbol goes out.

4. Within 30 seconds, press and hold the info button again for 3 seconds.
5. Turn the temperature selector until **c 10** appears on the temperature display.
6. Press and hold the **i** info button for 3 seconds.
The appliance is permanently unlocked.

Baking

In this section, you will find information on

- Baking on one level
- Baking on two or more levels
- The baking table
- The baking table for ready-made products
- Tips and tricks for baking

Note: Do not use shelf height 2 when baking with  CircoTherm®. The air circulation is impaired and this will have a negative effect on your baking.

We recommend that you use dark-coloured metal baking tins.

Tinplate and glass dishes increase the baking time required and the cake will not brown evenly.

If you wish to bake using tinplate tins and  Top/bottom heat, you should use shelf position 1.

Always slide the universal pan in carefully as far as it will go and make sure that the sloping edge is facing the appliance door.

Baking on one level

If you are baking on one level with  CircoTherm®, always place a round tin in the centre of the wire rack (figure A) and always place a loaf tin diagonally (figure B).

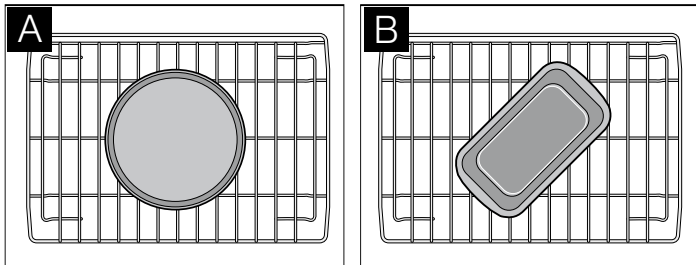

If you are baking on one level with  CircoTherm®, always place two round baking tins diagonally to each other on the wire rack (figure C).

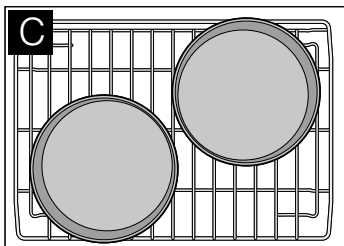

Baking on two or more levels

If you are baking on more than one level, only use the  CircoTherm® operating mode.

Bear in mind that your items may brown at different rates on each level. The items on the top level will brown more quickly and can be taken out earlier.

Two baking tins on two levels

When baking with two round baking tins or two baking trays, slide a wire rack in at shelf position 1 and a wire rack in at shelf position 3.

Place the lower baking tin to the left (figure A) and the upper baking tin to the right (figure B) on the wire rack.

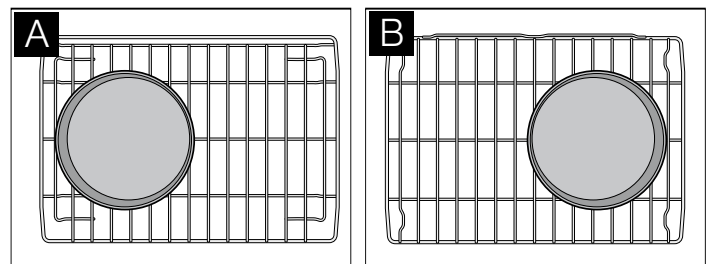

Four baking tins on two levels

When baking with four round baking tins, slide a wire rack in at shelf position 1 and a wire rack in at shelf position 3.

Always place baking tins on the wire rack (figure C).

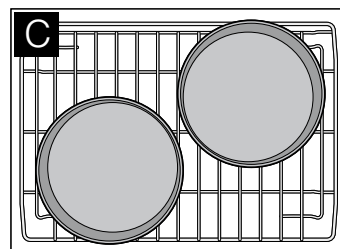





Baking table

The details given in the table are guidelines and apply to dark baking tins. The values may vary depending on the type and amount of the dough/mixture and on the baking tin.

We recommend that you set the lower of the specified temperatures the first time. Lower temperatures will generally allow more even browning.



If you are baking according to your own recipe, use similar recipes in the table as a guide.

Observe the notes in the table about preheating.

Meal	Setting	Level	Temperature in °C	Time in minutes
Victoria sponge cake		1	160-170*	25-30
		2	160-170*	20-30
		1+3	150-160*	25-35
Scones		1	180-200*	15-20
		3	210-220*	10-15
		1+3	180-200*	15-25
Small cakes		1	160-170*	20-30
		3	150-160*	25-35
		1+3	150-160*	25-35
Light fruit cake		1	140-150*	80-100
Rich fruit cake		1	140-150*	150-200
Jamtartes		1	190-200*	15-20
		3	200-210*	15-20
		1+3	190-200*	20-25
Swiss roll		1	180-190*	10-15
		2	190-200*	10-15
Tart		1	160-170*	55-65
		1	180-190*	50-60
		1+3	160-170*	50-60
Pies		1	170-180*	60-70
		1+3	170-180*	65-75
Biscuits		1	160-170*	15-20
		3	170-180*	15-20
		1+3	160-170*	15-20
		1+3+4	160-170*	15-25
Baiser		1	80*	100-130
		3	80*	100-130
Pavlova		1	90-100**	90-120
		3	80-90**	90-120
Fruit crumble		1	170-180*	45-55
		2	190-200*	45-50
Yorkshire pudding		1	190-200*	15-20
		2	200-230*	15-20
		1+3	190-200*	20-25
Vol au vents		1	190-200*	20-25
Quiche		1	180-200*	45-55
		1	190-210*	45-55
(White) bread		1	190-200*	25-35
		1+3	190-200*	25-40
Homemade pizza		1	190-200*	20-30
		2	210-220*	20-30
		1+3	190-200*	40-50

* Preheat oven

** Preheat the oven to 130 °C

Meal	Setting	Level	Temperature in °C	Time in minutes
Jacket potatoes		1	160-170	60-70
		2	170-180	60-70
		1+3	160-170	60-70

* Preheat oven

** Preheat the oven to 130 °C

Baking table for ready-made products

Notes

- Use the universal pan
- Only use greaseproof paper that is suitable for the selected temperature
- Spread chips out in a single layer
- Turn frozen potato products half way through the baking time
- Only season frozen potato products after they have finished baking
- Leave a little space between the dough when baking bread rolls. Do not place too many in the universal pan























- Cover the lasagne with plenty of cheese so that the top browns evenly
- Do not use frozen products with freezer burn
- Do not use frozen products that are heavily frosted
- Follow the manufacturer's instructions.

The details given in the table are guidelines and apply to the universal pan.

We recommend that you set the lower of the specified temperatures the first time. Lower temperatures will generally allow more even browning.

If you are baking on more than one level, only use the  CircoTherm® operating mode.

Observe the notes in the table about preheating.

Meal	Setting	Level	Temperature in °C	Time in minutes
Frozen pizza		1	180-200*	15-25
		2	190-210*	15-25
		1+3	170-190*	20-30
Chilled pizza		1	190-200*	10-20
		2	190-210*	10-15
		1+3	180-190*	20-25
Part-baked white bread		1	180-190*	10-15
		2	190-200*	10-20
		1+3	170-180*	10-15
Oven Chips		1	190-200*	20-25
		2	190-210*	25-30
Potato wedges		1	180-190*	20-25
		2	190-200*	20-25
Croquettes		1	180-190*	25-30
		2	190-200*	25-30
Fish fingers		1	180-200*	15-25
		2	190-210*	15-20
Lasagne, frozen (400 g)		1	180-190*	40-45
Lasagne, frozen (1200 g)		1	180-190*	45-50
Lasagne, chilled (400 g)		1	170-180*	25-30
		2	180-190*	25-35
Lasagne, chilled (1200 g)		1	170-180*	40-45
		2	190-200*	40-45

* Preheat oven

Tips and tricks

The cake is too light in colour	Check the shelf height. Check whether you have used the bakeware that we have recommended. Place your tin on the wire rack and not on the baking tray. If the shelf height and the bakeware are correct, then you should either extend the baking time or increase the temperature.
The cake is too dark	Check the shelf height. If the shelf height is correct, you should either shorten the baking time or reduce the temperature.
The cake is unevenly browned in the baking tin	Check the shelf height. Check the temperature. Make sure that your baking tin is not placed directly in front of the air outlets in the rear panel of the cooking compartment. Check that the baking tin is in the correct position on the wire rack.
The cake is too dry	Set a slightly higher temperature and a slightly shorter baking time.
The cake is too moist in the centre	Set a slightly lower temperature. Note: Higher temperatures may not mean shorter baking times (cooked on the outside, but not on the inside). Select a longer baking time and allow the cake mixture to prove for longer. Add less liquid to the mixture.
The cake collapses when you take it out of the oven	Use less liquid for the mixture. Set a longer baking time or a slightly lower temperature.
The specified baking time is not correct	For small items, check the quantity on the baking tray. Small items must not be touching each other.
Frozen products are not browned evenly after baking	Check whether the frozen product is unevenly pre-browned before baking. This uneven browning will remain after the baking time.
Several cakes on one level are unevenly browned	Check the position of the baking tins on the wire rack.
Frozen products are not browned, not crispy or the specified times are not correct	Remove ice from frozen products before baking. Do not use frozen products that are heavily frosted
Saving energy	Only preheat the appliance when it is specified in the baking table that you should do so. Use dark baking tins as these absorb the heat better. Make use of the residual heat with longer baking times and switch the oven off 5 - 10 minutes before the end of the baking time.

Roasting and braising

In this section, you will find information on

- Roasting
- Braising
- Tables for roasting and braising
- Tips and tricks

There is a risk of injury if you use roasting dishes that are not heat-resistant!

Only use roasting dishes that are marked as being suitable for use in the oven.

Do not use shelf height 2 when roasting with  CircoTherm®. The air circulation would be impaired and this will have a negative effect on your roast.

Roasting

Roasting dish without a lid is used for roasting.

When you are roasting with  Top/bottom heat, turn the roast approximately half to two thirds of the way through the roasting time.

Roasting in the universal pan

Juices escape from the roasting meat and are collected in the universal pan. You can use these juices as the basis for a tasty gravy.

Deglaze the pan of the juices with hot water, stock, wine or similar. Bring to the boil, thicken with cornflour, season and pass through a sieve if necessary.

You can also cook side dishes (e.g. vegetables) at the same time as roasting meat in the universal pan.

For smaller joints, you can use a smaller roasting dish instead of the universal pan. Place this directly on the wire rack.

Roasting in the universal pan with stepped wire rack

Place the stepped wire rack on the universal pan and slide them in together at the same shelf position.

For fatty meat and poultry, add 1/8 to 1/4 litre water to the universal pan, depending on the size and type of the joint.

While the meat is roasting, the liquid in the roasting dish will evaporate. Pour in more hot water if required.

Roasting in the universal pan with roasting sheet

The roasting sheet reduces dirt in the cooking compartment. Place the roasting sheet in the universal pan and slide them in together at the same shelf position.

Dripping fat and meat juices are caught in the universal pan.

Braising

For braising, a roasting dish with a lid is used. Ensure that the roasting dish and lid fit together well and close properly.

First, sear the meat if required.

Add the meat, vegetables and liquid to the roasting dish in equal proportions and place the dish with the lid closed on the wire rack at shelf position 1.

While the meat is braising, the liquid in the roasting dish will evaporate. Pour in more liquid if required.

Tables for roasting and braising

The details given in the table are guidelines and apply to food placed in a cold oven and for meat taken directly from the refrigerator.

Poultry

The information in the tables applies to unstuffed poultry. Turn the poultry after half of the cooking time.

Lean meat

Coat lean meat with fat or oil as required and cover it with strips of bacon.

Cooking time and temperature

The cooking time and temperature depend on the size, height, type and quality of the food and the roasting dish.

























As a general rule: the larger the item, the lower the temperature and the longer the roasting time.

You should set the lower of the specified temperatures the first time. Lower temperatures will generally allow more even browning.











The values for cooking time apply to 0.5 - 2 kg of food. For greater weights, reduce the temperature and increase the cooking time. For multiple pieces, apply the cooking time for the weight of the heaviest piece.

Standing time







At the end of the cooking time, switch the oven off and leave the roast to stand for approximately 10 minutes in the cooking compartment with the door closed. The recommended standing time is not included in the cooking times specified.

Meal	Type of heating	Level	Temperature in °C	Time in minutes (per 500 g)
Beef				
Slow roast joint		1	140	40+40
		2	150	40+40
Top side / top rump		1	160	30+25
		2	160	30+25
Lamb				
Leg		1	170	30+25
		2	200	30+25
Shoulder (bone-in)		1	170	25+20
		2	200	25+20
Shoulder (boned and rolled)		1	170	30+25
		2	200	30+25
Rack of lamb		1	180	25+25
		2	200	25+25
Pork				
Roast joint		1	180	35+35
		2	180	35+35
Loin joint		1	180	30+30
		2	180	30+30
Belly		1	160	30+25
		2	190	30+25
Gammon				
Joint		1	160	30+30
		2	190	30+30
Chicken				
Whole chicken		1	180-190	20+25
		2	190-200	20+25
Portion (boneless)		1	190	20+25
		2	200-210	20+25

* + time for yorkshire pudding

Meal	Type of heating	Level	Temperature in °C	Time in minutes (per 500 g)
Quarter		1	190	20+25
		2	200-210	20+25
Duck				
Duck		1	180	20+20
Duck		2	190-200	20+20
Turkey				
Drumstick		1	180	20+20
Crown		1	160	25+20
Whole (3-4 kg)		1	160-170	15+10
Whole (4,5-8 kg)		1	150-160	13+10
Whole (8,5-12 kg)		1	140-150	12+10
Complete Meal				
With beef		1+3	160	30+25*

* + time for yorkshire pudding

Casseroles	Type of heating	Level	Temperature in °C	Time in minutes (per 500 g) + additional time
Diced meat (beef, pork, lamb, chicken)		1	140	40+80
		1	140*	40+80
Braising steak		1	140	45+80
		1	140*	45+80
Chicken pieces (boned)		1	140	50+70
		2	140	50+70



* Preheat oven

Tips and tricks

Crust too thick and/or roast too dry	Reduce the temperature or shorten the roasting time. Check the shelf height.
Crust too thin	Increase the temperature or switch on the grill briefly at the end of the roasting time.
The meat is not cooked right through	Remove any accessories that are not required from the cooking compartment. Increase the roasting time. Check the core temperature of the joint using a meat thermometer.
Steam in the cooking compartment is condensing on the appliance door	The steam dries during the course of the cooking. If there is an excessive volume of steam, you can carefully open the door briefly to dissipate the steam more quickly.
The meat is burned slightly during braising	Add the meat, vegetables and liquid to the roasting dish in equal proportions. The roasting dish and lid must fit together well and close properly. Reduce the temperature.

Grilling

In this section, you will find information on

- grilling in general
- Circo-roasting 
- radiant grilling 

⚠ There is a risk of injury if you use roasting dishes that are not heat-resistant!

Only use roasting dishes that are marked as being suitable for use in the oven.

Caution!

Material damage due to effect of heat: The temperature generated in the cooking compartment is very high. Keep the appliance door closed when using the grill. Never grill with the appliance door open.

Notes

- Always use the stepped wire rack and the universal pan when grilling.
- Place the insert grid into the universal pan and slide the two in together at the shelf position specified in the grilling table
- Always place the food to be grilled in the centre of the stepped wire rack
- If you are grilling more than one piece of meat, make sure that they are the same sort of meat and that they are of similar thickness and weight.

Circo-roasting

The  Circo-roasting operating mode is particularly suitable for poultry or meat (e.g. roast pork with crackling) that is to be crispy.

Turn large items of food after approximately half to two-thirds of the grilling time. For items of food with rind, place them on the wire rack rind-side down for the first half of the grilling time.

Pierce duck and goose skin under the wings and legs to allow the fat to escape.

Depending on the type of food you are cooking, the cooking compartment may become very dirty when you cook food on the wire rack using Circo-roasting. You should therefore clean the cooking compartment after every use so that the dirt does not become burnt on.

At the end of the cooking time, switch the grill off and leave the food to stand for approximately 10 minutes in the cooking compartment with the door closed. The recommended standing time is not included in the grilling times specified.

Radiant grilling

Brush the items to be grilled with a little oil to taste.

Turn the items after half to two-thirds of the grilling time.

The details in the table are only guide values. The values may vary depending on the type and amount of food to be grilled. They are for food placed in a cold oven and for meat taken directly from the refrigerator.

You can influence the grilling result by changing the type or position of the wire rack.

Wire rack position Use



Place the stepped wire rack in the universal pan with the step pointing downwards: suitable for items that should be well-done



Place the stepped wire rack in the universal pan with the step pointing upwards: suitable for items that should be rare to medium

Note: Always use the universal pan in the standard position (not the other way up).



Grilling table

The details given in the table are guidelines and apply to the enamelled universal pan with stepped wire rack. The values may vary depending on the type and amount of items to be grilled.

You should set the lower of the specified temperatures the first time. Lower temperatures will generally allow more even browning.

The values refer to food placed in the oven when it is cold and for meat taken directly from the refrigerator.

Food	Type of heating	Level	Temperature in °C and <i>int</i>	Time in minutes
Beef				
Steaks, height 2-3 cm		4	<i>int</i> *	1 st side: 9-12 2 nd side: 5-7
Burgers, height 1-2 cm		4	<i>int</i> *	1 st side: 8-10 2 nd side: 6-8
Lamb				
Leg		2	170-190	120-150***
Shoulder (bone-in)		2	170-190	100-130***
Shoulder (boned and rolled)		1	170-190	120-150***
Steaks, height 2-3 cm		4	<i>int</i> *	1 st side: 5-7 2 nd side: 3-5
Chops, height 2-3 cm		3	<i>int</i> *	1 st side: 9-12 2 nd side: 6-8
Pork				
Roast joint		2	180-200	120-150***
Steaks, height 1-2 cm		4	<i>int</i> *	1 st side: 8-10 2 nd side: 6-8
Chops, height 2-3 cm		4	<i>int</i> *	1 st side: 10-12 2 nd side: 8-10
Burgers, height 1-2 cm		4	<i>int</i> *	1 st side: 8-10 2 nd side: 6-8
Sausages, Ø 2-4 cm		4	<i>int</i> *	10-15**

* Preheat for 3 minutes

** Turn frequently

***Turn after half of the time

Food	Type of heating	Level	Temperature in °C and <i>int</i>	Time in minutes
Gammon				
Steaks, height 1-2 cm		4	<i>int</i> *	1 st side: 8-12 2 nd side: 4-6
Chicken				
Drumsticks (each 150-200g)		3	250*	1 st side: 17-20 2 nd side: 10-12
Breast (boneless)		4	250*	1 st side: 10-15 2 nd side: 7-10
Whole		2	200-220	70-90***
Quarter		2	210-230	40-50***
Fish				
Whole fish, e.g. trout		3	220*	1 st side: 10-15 2 nd side: 10-15
Whole fish, e.g. trout		2	220	15-25
Filets		4	220*	1 st side: 8-12 2 nd side: 6-10

* Preheat for 3 minutes

** Turn frequently

***Turn after half of the time

Defrosting

In this section, you can read about

- how to defrost using CircoTherm®
- how to use the Defrost operating mode

Defrosting with CircoTherm®

Use CircoTherm® to defrost and cook frozen products.

Notes

- Frozen products that have been defrosted (meat in particular) require shorter cooking times than fresh products
- The cooking time for frozen meat increases by the defrosting time
- Always defrost frozen poultry before cooking so that you can remove the giblets
- Cook frozen fish at the same temperatures as fresh fish
- You can place large quantities of ready made frozen vegetables in aluminium dishes in the cooking compartment at the same time
- Use shelf height 1 when defrosting on one level, and shelf heights 1 + 3 when using two levels
- Observe the instructions on the packaging when using frozen foods.

Defrost

Using defrost setting you can defrost delicate pastries particularly well (e.g. cream cakes).

1. Switch on the Defrost operating mode.
2. Defrost the frozen food for 25-45 minutes, depending on type and size.
3. Remove the frozen food from the cooking compartment and let it thaw for 30 - 45 minutes.

With small quantities (pieces), the defrosting time is shortened to 15-20 minutes and the extended defrosting time is shortened to 10-15 minutes.

Frozen meals	Temperature in °C	Defrosting time in minutes
Raw frozen products/ foods	50	30 - 90
Bread/Bread rolls (750 - 1,500 g)	50	30 - 60
Dry, frozen tray bakes	60	45 - 60
Moist, frozen tray bakes	50	50 - 70

Preserve

Risk of injury!

Preserving jars containing incorrectly preserved food can burst. Please observe the following instructions:

- Fruit and vegetables must be fresh and in good condition
- Only use clean and undamaged preserving jars
- The preserving jars must not touch each other in the cooking compartment during preserving

With  CircoTherm®, the cooking compartment can be used to preserve the contents of up to six ½, 1 or 1½ litre preserving jars at the same time.

Notes

- For each preserving process, only use preserving jars that are the same size and contain the same food.
- Pay attention to cleanliness when preparing and closing the preserving jars.
- Only use heat resistant rubber rings.
- You cannot preserve the following food in your appliance: the contents of tin cans, meat, fish or pie filling.

Preparing fruit

1. Wash fruit and, depending on the type, peel, remove the seeds and finely chop.
2. Fill the preserving jars with fruit up to approx. 2 cm below the rim.
3. Fill the preserving jars with hot, skimmed sugar solution (approx. ⅓ l for a one litre jar).

To one litre water:

- approx. 250 g sugar for sweet fruit
- approx. 500 g sugar for sour fruit

Preparing vegetables

1. Wash vegetables and depending on the type, clean and finely chop.
2. Fill the preserving jars with vegetables up to approx. 2 cm below the rim.
3. Fill the preserving jars immediately with hot, boiled water.

Closing the preserving jars

1. Wipe the rims of the preserving jars with a clean, damp cloth.
2. Put a wet rubber ring and lid in place and close the jars with the clips.

Starting the preserving process

1. Insert the universal pan at shelf height 1.
2. Position the preserving jars in a triangle without them touching each other.



3. Pour ½ litre of hot water (approx. 80 °C) into the universal pan.
4. Set  CircoTherm® at 160 °C.

- Preserving jars containing ½ or 1 litre will start to bubble after approx. 50 minutes
- Preserving jars containing 1½ litres will start to bubble after approx. 60 minutes

Ending the preserving process

For fruit, gherkins and tomato purée:

1. Turn off the appliance, once all preserving jars are bubbling.
2. Allow the preserving jars to stand in the closed cooking compartment for several minutes longer.
 - Raspberries, strawberries, cherries or gherkins: approx. 5 - 10 minutes
 - Other fruit: approx. 10 - 15 minutes
 - Tomato or apple purée: approx. 15 - 20 minutes

For vegetables:

1. Reduce the temperature to 100 °C once all the preserving jars are bubbling. Allow the preserving jars to continue bubbling for approx. 60 minutes in the closed cooking compartment.
2. Switch off the appliance.
3. Allow the preserving jars to stand in the closed cooking compartment for approx. 15 - 30 minutes longer.

Removing the preserving jars

1. Place the preserving jars on a clean cloth, cover and protect from draughts.
2. Remove clips only when the jars are cold.

Pyrolytic cleaning

With Pyrolytic cleaning, the oven heats up to approximately 500 °C. This burns off residues from roasting, grilling or baking and you only need to wipe the ashes from the cooking compartment.

You can choose from three cleaning levels.

Level	Degree of cleaning	Cooking time
1	gentle	approx. 1 hour, 15 minutes
2	medium	approx. 1 hour, 30 minutes
3	intensive	approx. 2 hours

The heavier and older the dirt, the higher the cleaning level should be. We recommend cleaning the cooking compartment at least once very one to two months. Depending on usage and what has been cooked more frequent cleaning may be necessary. A cleaning cycle only requires approx. 2.5 - 4.7 kilowatt hours.

Important notes

For safety reasons, the oven door locks automatically. You can only open the oven door again once the cooking compartment has cooled down slightly. Do not attempt to push in the latch by hand.

Do not attempt to open the oven door while the cleaning programme is in operation. The cleaning process may be cancelled.

The lamp is not lit in the cooking compartment during cleaning.

Risk of fire!

The outside of the oven becomes very hot. Make sure that nothing is placed against the front of the oven. Never hang flammable objects, e.g. tea towels, on the door handle. Keep children at a safe distance.

Before cleaning

The oven must be empty. Take any accessories, ovenware and shelves out of the oven. Please see the *Care and cleaning* section for how to unhook the rails.

Clean the oven door and the along the edges of the cooking compartment in the area around the seal. Do not scrub the seal.

Make sure that the oven door is closed before you start cleaning.

Risk of fire!

Loose food residues, grease and meat juices may catch fire. Wipe out the cooking compartment with a damp cloth.

Cleaning accessories at the same time

The shelves are not suitable for the self-cleaning programme. Take them out of the cooking compartment. If you wish to clean accessories at the same time, you can buy accessory holders.

You can obtain the accessory holders from the after-sales service or on the internet using the material number 466546.

The accessory holders are inserted on the left- and right-hand sides.

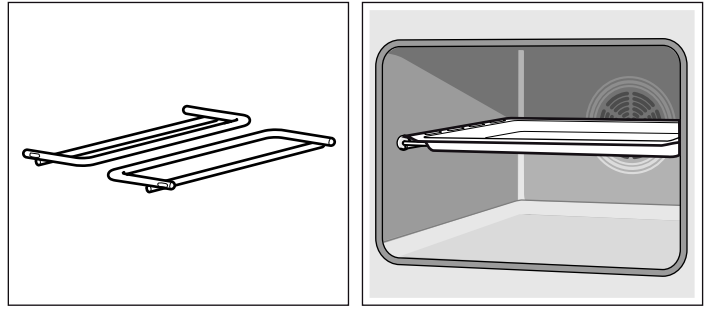

You can use the holder to clean enamelled accessories without a non-stick coating at the same time, e.g. the universal pan. Always only clean one accessory at a time.

Non-enamelled accessories, e.g. the wire rack, are not suitable for the self-cleaning programme. Remove them from the cooking compartment.

Risk of serious damage to health.!

Never clean non-stick baking trays and baking tins at the same time using the self-cleaning programme. High temperatures damage the non-stick coating and poisonous gases are released.

Note: For details on which accessories are suitable for the self-cleaning programme, please see the optional accessory table at the start of these instructions.



Setting the cleaning level

1. Set the operating mode selector to . 0 appears in the temperature display.
2. Use the temperature selector to set the cleaning level. Pyrolytic cleaning starts after a few seconds.

The clock display shows the cleaning duration. The oven will start up after a few seconds. The time starts counting down.

After the programme starts, the oven door locks.

Once cleaning has finished

0:00 appears in the clock display and  flashes. Set the operating mode selector to 0 and press the  button once. You can only open the oven door once the oven has cooled down.

Cancelling cleaning



Turn the operating mode selector back to 0. You can only open the oven door once the oven has cooled down.

Changing the cleaning level

Once the programme has started, you can no longer change the cleaning level.

Setting cleaning to run overnight

So that you can use your oven throughout the day, delay the end of the cleaning process to during the night. Make settings as described in steps 1 and 2.

1. Press the  clock function button until the  symbol appears.
2. Set the End of operation to a later end time using the rotary selector.
The oven switches to standby. The display shows the time of day. When the oven starts, you can see the time counting down.

After cleaning

Once the cooking compartment has cooled down, wipe out the ash that has been left behind in the cooking compartment with a damp cloth.

Care and cleaning

With good care and cleaning, your oven will remain clean and fully-functioning for a long time to come. Here we will explain how to maintain and clean your oven correctly.

Notes

- Slight differences in the colours on the front of the oven are caused by the use of different materials, such as glass, plastic and metal.
- Shadows on the door panel which look like streaks, are caused by reflections made by the oven light.
- Enamel is baked on at very high temperatures. This can cause some slight colour variations. This is normal and does not affect their function. The edges of thin trays cannot be completely enamelled. As a result, these edges can be rough. This will not impair the anti-corrosion protection.

Cleaning agents

To ensure that the different surfaces are not damaged by using the wrong cleaning agent, observe the information in the table. Do not use

- aggressive or abrasive cleaning agents,
- cleaning agents with a high concentration of alcohol,
- hard scouring pads or sponges,
- high-pressure cleaners or steam cleaners.

Wash new sponge cloths thoroughly before use.

Area	Cleaning agents
Oven front	Hot soapy water: Clean with a dish cloth and dry with a soft cloth. Do not use glass cleaners or glass scrapers.
Stainless steel	Hot soapy water: Clean with a dish cloth and dry with a soft cloth. Remove flecks of limescale, grease, starch and albumin (e.g. egg white) immediately. Corrosion can form under such residues. Special stainless steel cleaning products suitable for hot surfaces are available from our after-sales service or from specialist retailers. Apply a very thin layer of the cleaning product with a soft cloth.
Door panels	Glass cleaner: Clean with a soft cloth. Do not use a glass scraper.
Door cover	Stainless steel cleaning agents (available from our after-sales service or from specialist retailers): Please observe the manufacturer's instructions.

Area	Cleaning agents
Cooking compartment	Hot soapy water or a vinegar solution: Clean with a dish cloth. If there are heavy deposits of dirt, use a stainless steel scouring pad or oven cleaner. Only use when the cooking compartment is cold. It is best to use the self-cleaning function. Observe the instructions in the <i>Pyrolytic cleaning</i> section.
Glass cover for the oven light	Hot soapy water: Clean with a dish cloth.
Shelves	Hot soapy water: Soak and clean with a dish cloth or brush.
Telescopic shelves	Hot soapy water: Clean with a dish cloth or a brush. Do not soak. Clean in the dishwasher, or in the oven as part of the self-cleaning programme. The rails may be damaged causing them to jam.
Accessories	Hot soapy water: Soak and clean with a dish cloth or brush.

Cleaning the hook-in racks

You can remove the hook-in racks for easier cleaning.

⚠ Risk of burning due to hot components in the cooking compartment!

Wait until the cooking compartment has cooled down.

1. Push the hook-in rack upwards at the front and unhook to the side (figure A).
2. Pull the hook-in rack forwards at the rear and unhook to the side (figure B).

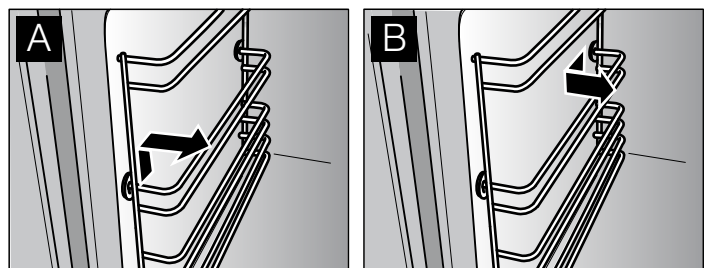

3. Clean the hook-in rack with washing-up liquid and a sponge or brush.
4. Align the hook-in rack with the indentation (a) facing downwards, so that the shelf heights match.
5. Insert the hook-in rack at the rear as far as it will go and push to the rear (figure C).

6. Insert the hook-in rack at the front as far as it will go and push downwards (figure D).

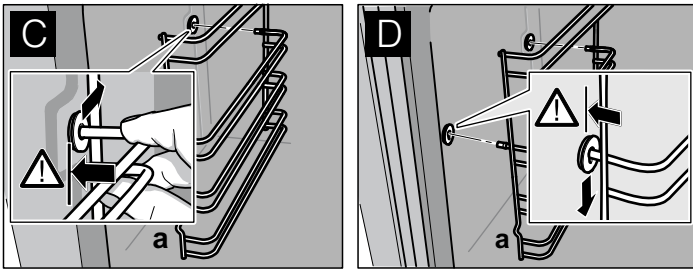

Detaching and attaching the oven door

For cleaning purposes and to remove the door panels, you can detach the oven door.

The oven door hinges each have a locking lever. When the locking levers are closed (figure A), the oven door is secured in place. It cannot be detached. When the locking levers are open in order to detach the oven door (Fig. B), the hinges are locked. They cannot snap shut.

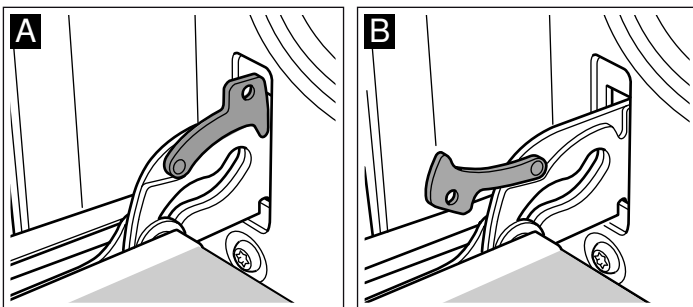

⚠ Risk of injury!

Whenever the hinges are not locked, they snap shut with great force. Ensure that the locking levers are always fully closed or, when detaching the oven door, fully open.

Detaching the door

1. Open the oven door fully.
2. Fold up the two locking levers on the left and right (figure A).
3. Close the oven door as far as the limit stop. With both hands, grip the door on the left and right-hand sides. Close the door a little further and pull it out (figure B).

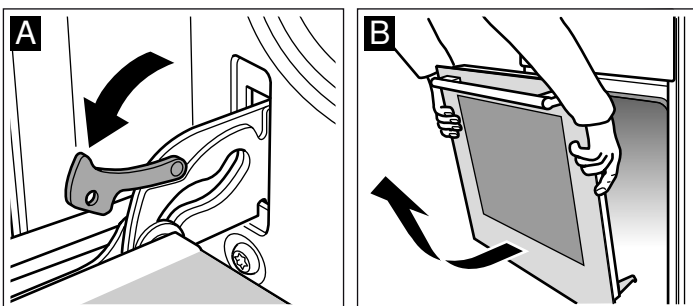

Attaching the door

Reattach the oven door in the reverse sequence to removal.

1. When attaching the oven door, ensure that both hinges are inserted straight into the opening (figure A).
2. The notch on the hinge must engage on both sides (figure B).

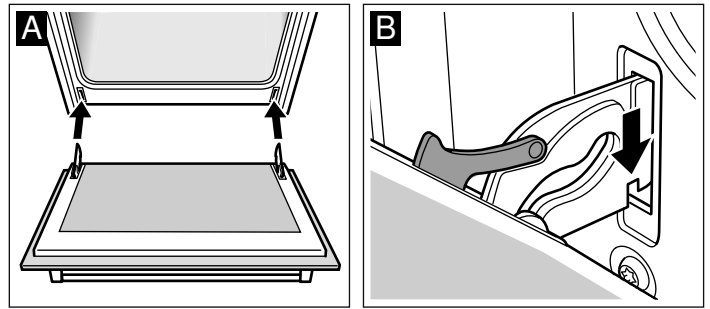

3. Fold back both locking levers (figure C). Close the oven door.

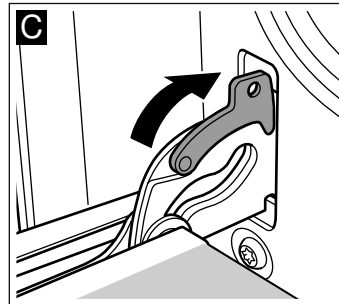

⚠ Risk of injury!

If the oven door falls out accidentally or a hinge snaps shut, do not reach into the hinge. Call the after-sales service.

Removing the door cover

The oven door cover can become discoloured. To carry out thorough cleaning, you can remove the cover.

1. Open the oven door fully.
2. Unscrew the oven door cover. To do this, undo the left and right screws (figure A).
3. Remove the cover (figure B).

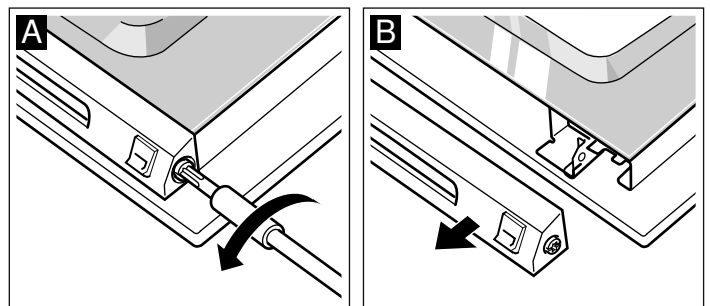

Make sure that the oven door is not closed while the cover is removed. The inner panel may be damaged.

Clean the cover with a stainless-steel cleaning agent.

4. Replace the cover and secure it in position.
5. Close the oven door.

Removing and installing the door panels

To facilitate cleaning, you can remove the glass panels from the oven door.

When removing the inner panels, pay attention to the sequence in which the panels are removed. In order to reassemble the panels in the correct sequence, use the numbers that appear on each panel.

Removal

1. Detach the oven door and lay it on a cloth with the handle facing down.
2. Unscrew the cover at the top of the oven door. To do this, unscrew the left and right screws (fig. A).
3. Lift the top panel up and pull it out and remove the two small seals (fig. B).

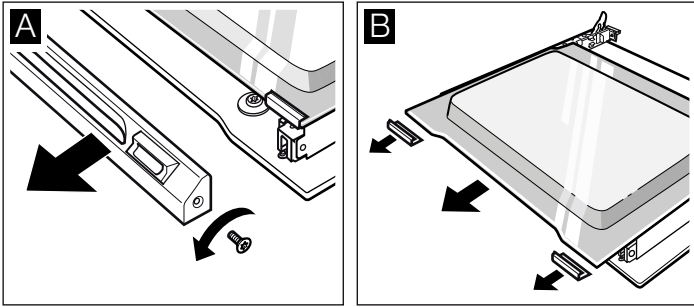

4. Unscrew the retaining clips on the right and left. Lift the panel and remove the clips from the panel (fig. C).
5. Remove the seal from the bottom of the panel (fig. D). Pull the seal and remove it up and out. Pull out the panel.

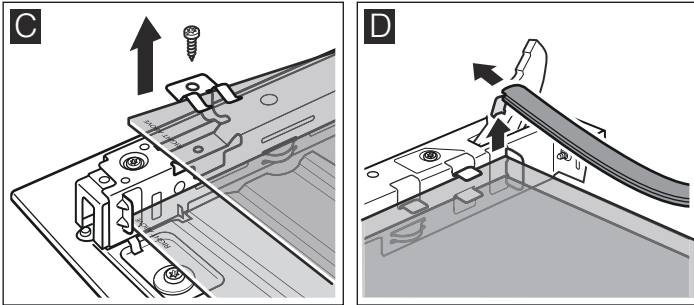

6. Pull the lower panel at an angle, upwards and out.
7. Do NOT unscrew the left and right-hand screws from the sheet metal part (fig. E).

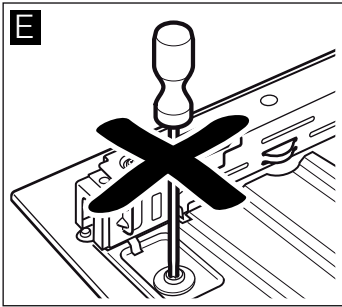

Clean the panels with glass cleaner and a soft cloth.

⚠ Risk of injury!

Scratched glass in the appliance door may develop into a crack. Do not use a glass scraper, sharp or abrasive cleaning aids or detergents.

Installation

During installation, make sure that the lettering "top right" is upside down at the bottom left of both panels.

1. Insert the lower panel at an angle towards the back (fig. A).
2. Slide in the middle panel (fig. B).

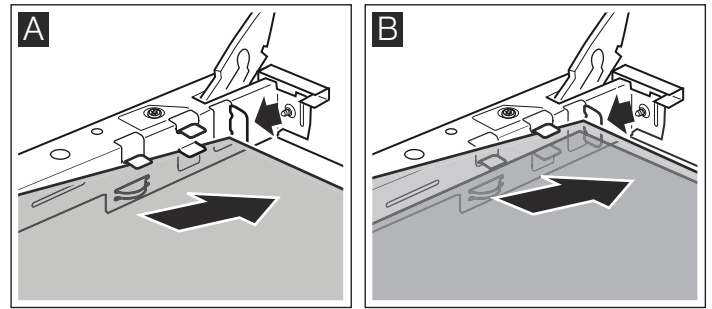

3. Stick the retaining clips onto the right and left-hand side of the panel, aligning them so that the retaining carriers are over the screw holes, and then screw into place (fig. C).
4. Hook the seal in to the bottom of the panel again (fig. D).

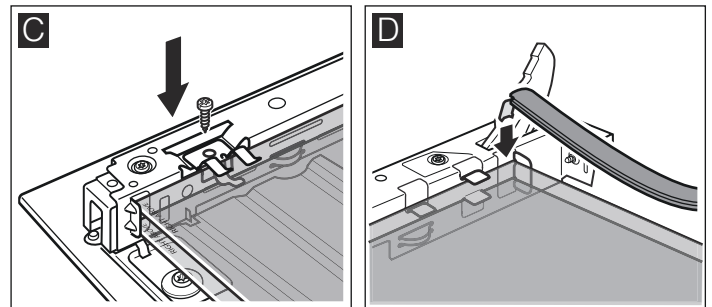

5. Insert the uppermost panel at an angle to the back into the brackets. Take care not to push the seal to the back (fig. E).
6. Insert the two small seals on the left and right of the panel again (fig. F).

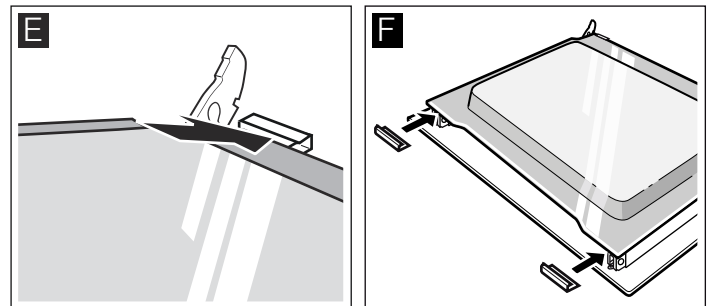

7. Put the cover back in place and screw it on.
8. Attach the oven door.

Do not use the oven again until the panels have been correctly installed.



Faults and repairs

It is not always necessary to call the after-sales service. Sometimes, you can find a remedy yourself. You will find some tips for troubleshooting in the following table.

Risk of electric shock!

- Work on the appliance electronics may only be performed by a specialist.
- Always disconnect the appliance from the power supply when work is carried out on the electronics. Switch off the circuit breaker or remove the fuse from your household fuse box.

Malfunction table

Problem	Possible cause	Note/remedy
Electrical operation is faulty (e.g. indicator lamps no longer light up).	Circuit breaker faulty.	Check fuses in the fuse box and replace if necessary.
Liquid or thin batter runs to one side.	Appliance not installed level.	Check appliance installation (see the Installation instructions).
Appliance no longer works, 0:00 flashes in the clock display.	There was a power cut.	Reset the time of day (see section: Electronic clock).
0:00 flashes on the clock display, "rrr" appears on the temperature display.	The power supply was interrupted while the appliance was in operation.	Press the clock function button, reset the time of day (see section: Electronic clock).
The temperature display shows, EXXX, e.g. E300 .	Internal fault in the appliance electronics.	Press the clock function button. If the message does not go out, pull out the mains plug and plug it back in again after approx. 10 seconds.
Appliance operation is not possible,  and -5 appear in the temperature display.	The appliance controls have been locked.	Deactivate lock (see section: Childproof lock).
Appliance operation is not possible,  and -5P appear in the temperature display.	The appliance controls were locked permanently.	Deactivate permanent lock (see section: Childproof lock).
The appliance does not heat up, the colon flashes on the clock display, 150o appears in the temperature display, for example.	A button combination was actuated.	Switch off the appliance, press and hold the info button for 3 seconds, then press and hold the clock function button for 4 seconds before pressing and holding the info button again for a further 3 seconds.
Electronically-controlled functions are faulty.	Energy surges (e.g. lightning strike).	Reset the function concerned.
When an operating mode is switched on, H or h appears in the temperature display.	The appliance has not cooled down fully.	Wait until the appliance has cooled down, then switch on the operating mode again.
The appliance has switched off automatically, 000 flashes in the temperature display.	The appliance has switched off to protect itself from overheating.	Turn the operating mode selector back to the 0 position.
Smoke is generated during roasting or grilling.	Fat is burning on the grill element.	Continue grilling or roasting until the fat on the grill element is burnt away.
	Wire rack or universal pan inserted incorrectly.	Place the wire rack in the universal pan and insert them together at a lower shelf height.
High levels of condensation are generated in the cooking compartment.	Normal occurrence (e.g. when baking cakes with very moist topping or cooking a large roast).	Open the appliance door briefly from time to time during operation.
Enamelled accessories have light, matt marks.	Normal occurrence caused by dripping meat or fruit juices.	Not possible
Door panels are steamed up.	Normal occurrence caused by temperature differences.	Heat the appliance up to 100 °C and then switch off again after 5 minutes.

Error messages with E

If an error message with E is shown in the display, press the  button. This cancels the error message. You may then have

to reset the time of day. If the error is shown again, call the after-sales service.

You can take remedial action yourself if the following error messages are displayed.

Error message	Possible cause	Note/remedy
E011	A button was pressed for too long or has jammed.	Press all buttons individually. Check that the buttons are clean. If the error message remains, please contact the after-sales service.
E115	The temperature in the cooking compartment is too high.	The oven door locks. Wait until the cooking compartment has cooled down. Clear the error message with the  button.

Replacing the bulb in the oven ceiling light

If the bulb in the oven light fails, it must be replaced. Heat-resistant, 40 watt spare bulbs can be obtained from our after-sales service or a specialist retailer. Only use these bulbs.

Risk of electric shock!

Switch off the circuit breaker in the fuse box.

1. Place a tea towel in the oven when it is cold to prevent damage.
2. Remove the glass cover. To do this, press back the metal tabs with your thumb (Fig. A).
3. Unscrew the bulb and replace it with one of the same type (Fig. B).

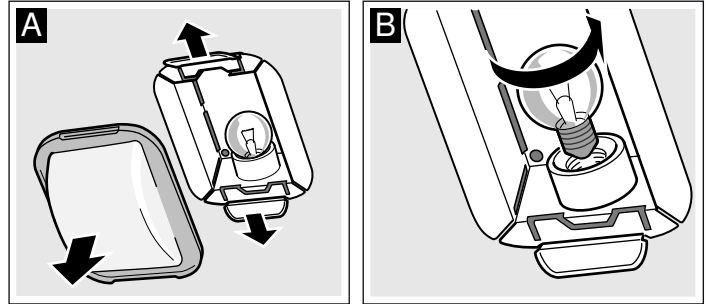

4. Refit the glass cover. When doing this, insert it on one side and press firmly on the other side. The glass cover will click into place.
5. Remove the tea towel and switch on the circuit breaker.

Glass cover

You must replace a damaged glass cover. Suitable glass covers may be obtained from the after-sales service. Please specify the E number and FD number of your appliance.

After-sales service

Our after-sales service is there for you if your appliance needs to be repaired. We will always find the right solution in order to avoid unnecessary visits from a service technician.

E number and FD number

When calling us, please give the product number (E no.) and the production number (FD no.) so that we can provide you with the correct advice. The rating plate containing these numbers can be found on the right-hand side of the oven door. You can make a note of the numbers of your appliance and the telephone number of the after-sales service in the space below to save time should it be required.

E no. _____ FD no. _____

After-sales service

Please note that there will be a fee for a visit by a service technician in the event of a malfunction, even during the warranty period.

Please find the contact data of all countries in the enclosed customer service list.

To book an engineer visit and product advice

GB 0344 892 8989

Calls charged at local or mobile rate.

IE 01450 2655

0.03 € per minute at peak. Off peak 0.0088 € per minute.

Rely on the professionalism of the manufacturer. You can therefore be sure that the repair is carried out by trained service technicians who carry original spare parts for your appliances.

Test dishes

These tables have been produced for test institutes to facilitate the inspection and testing of the various appliances.

Test dishes tested to standard EN 50304/EN 60350 (2009) and IEC 60350.

Please note the information in the tables about preheating. The table values do not include Rapid heat up.

Note: For baking, use the lower of the temperatures indicated first.

Baking	Cookware	Setting	Level	Temperature in °C	Time in minutes
Shortbread	Baking tray***	☐	3	140-150*	25-35
	Baking tray***	☒	1	140-150*	25-35
	2 baking trays***	☒	1+3	140-150*	30-40
	3 baking trays***	☒	1+3+4	130-140*	40-50
Small cakes (x 20)	Baking tray***	☐	3	160-170**	20-30
	Baking tray***	☒	1	150-160**	25-30
	2 baking trays***	☒	1+3	140-150**	30-40
	3 baking trays***	☒	1+3+4	140-150**	35-50
Fat-free sponge cake	Springform cake tin, dia. 26 cm	☐	2	160-170*	25-35
	Springform cake tin, dia. 26 cm	☒	1	160-170*	30-40
Apple pie, 1 level	2 x Springform cake tin, dia. 20 cm (see fig. A)	☐	2	180-190	70-90
	2 x Springform cake tin, dia. 20 cm (see fig. A)	☒	1	170-180*	65-75
Apple pie, 2 levels	2 x Springform cake tin, dia. 20 cm (see fig. B and C)	☒	1+3	170-180	65-75

* Preheat for 10 minutes

** Preheat oven

*** Only use original baking trays, order no. Z1342X0

When baking apple pie using CircoTherm® ☒, always place both springform cake tins diagonally on the stepped wire rack (fig. A).

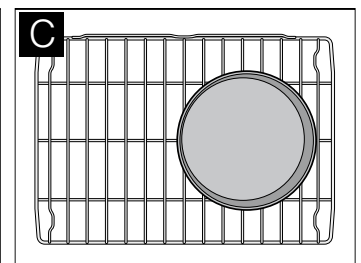
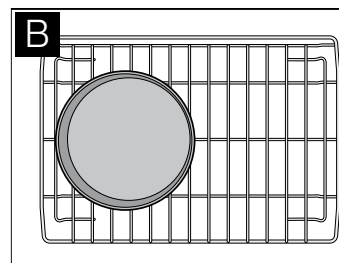
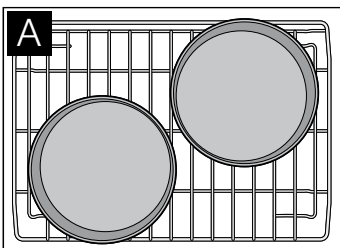

When baking apple pie on two levels, place the lower baking tin to the left on the stepped wire rack (fig. B) and the upper baking tin to the right on the straight wire rack (fig. C).

Grilling	Cookware	Wire rack position	Setting	Level	Temperature in °C and <i>in t</i>	Time in minutes
White bread	universal pan + wire rack	☐	☒	4	275*	1-3
Beefburger**	universal pan + wire rack	☐	☒	4	<i>in t</i>	20-25

* Preheat for 10 minutes

** Turn after 2/3 of the time



Constructa-Neff
Vertriebs-GmbH
Carl-Wery-Straße 34
D-81739 München
GERMANY

Register your product online

www.neff-international.com



9001135889

45

960211