



Extractor hood

[en] Instruction manual

I90CL46N0



Important safety information.....3
Environmental protection4
 Saving energy.....4
 Environmentally-friendly disposal.....4
Operating mode.....4
 Circulating-air mode4
Operating the appliance5
 Controls5
 Switching the appliance on and off.....5
 Intensive setting5
 Intermittent mode6
 Run-on function6
 Lighting6
Cleaning and maintenance.....6

Saturation display7
 Removing and installing the filter7
Trouble shooting8
 LED lights8
 Malfunction table.....8
After-sales service9
Special accessories9

Additional information on products, accessories, replacement parts and services can be found at www.neff-international.com and in the online shop www.neff-eshop.com

Important safety information

Read these instructions carefully. Only then will you be able to operate your appliance safely and correctly. Retain the instruction manual and installation instructions for future use or for subsequent owners.

The appliance can only be used safely if it is correctly installed according to the safety instructions. The installer is responsible for ensuring that the appliance works perfectly at its installation location.

This appliance is intended for domestic use and the household environment only. The appliance is not intended for use outside. Do not leave the appliance unattended during operation. The manufacturer is not liable for damage which is caused by improper use or incorrect operation.

This appliance is intended for use up to a maximum height of 2000 metres above sea level.

This appliance may be used by children over the age of 8 years old and by persons with reduced physical, sensory or mental capabilities or by persons with a lack of experience or knowledge if they are supervised or are instructed by a person responsible for their safety how to use the appliance safely and have understood the associated hazards.

Children must not play with, on, or around the appliance. Children must not clean the appliance or carry out general maintenance unless they are at least 8 years old and are being supervised.

Keep children below the age of 8 years old at a safe distance from the appliance and power cable.

Check the appliance for damage after unpacking it. Do not connect the appliance if it has been damaged in transport.

Only a licensed professional may connect appliances without plugs. Damage caused by incorrect connection is not covered under warranty.

This appliance is not intended for operation with an external clock timer or a remote control.

Danger of suffocation!

Packaging material is dangerous to children. Never allow children to play with packaging material.

Risk of fire!

- Grease deposits in the grease filter may catch fire. **Replace the grease filter at least every two months.** Never operate the appliance without the grease filter.
- Grease deposits in the grease filter may catch fire. Never work with naked flames close to the appliance (e.g. flambéing). Do not install the appliance near a heat-producing appliance for solid fuel (e.g. wood or coal) unless a closed, non-removable cover is available. There must be no flying sparks.
- Hot oil and fat can ignite very quickly. Never leave hot fat or oil unattended. Never use water to put out burning oil or fat. Switch off the hotplate. Extinguish flames carefully using a lid, fire blanket or something similar.
- When gas burners are in operation without any cookware placed on them, they can build up a lot of heat. A ventilation appliance installed above the cooker may become damaged or catch fire. Only operate the gas burners with cookware on them.
- Operating several gas burners at the same time gives rise to a great deal of heat. A ventilation appliance installed above the cooker may become damaged or catch fire. Never operate two gas burners simultaneously on the highest flame for longer than 15 minutes. One large burner of more than 5 kW (wok) is equivalent to the power of two gas burners.

Risk of burns!

The accessible parts become very hot when in operation. Never touch hot parts. Keep children at a safe distance.

Risk of injury!

- Components inside the appliance may have sharp edges. Wear protective gloves.
- Items placed on the appliance may fall down. Do not place any objects on the appliance.
- The light emitted by LED lights is very dazzling, and can damage the eyes (risk group 1). Do not look directly into the switched on LED lights for longer than 100 seconds.

Risk of electric shock!

- A defective appliance may cause electric shock. Never switch on a defective appliance. Unplug the appliance from the mains or switch off the circuit breaker in the fuse box. Contact the after-sales service.
- Incorrect repairs are dangerous. Repairs may only be carried out and damaged power cables replaced by one of our trained after-sales technicians. If the appliance is defective, unplug the appliance from the mains or switch off the circuit breaker in the fuse box. Contact the after-sales service.
- Do not use any high-pressure cleaners or steam cleaners, which can result in an electric shock.

Causes of damage

Caution!

Risk of damage due to corrosion. Always switch on the appliance while cooking to avoid condensation. Condensate can produce corrosion damage.

Risk of damage due to ingress of humidity into the electronic circuitry. Never clean operator controls with a wet cloth.

Surface damage due to incorrect cleaning. Clean stainless steel surfaces in the direction of the grain only. Do not use any stainless steel cleaners for operator controls.

Surface damage due to strong or abrasive cleaning agents. Never use strong and abrasive cleaning agents.

Risk of damage from returning condensate. Install the exhaust duct in such a way that it falls away from the appliance slightly (1° slope).

Environmental protection

Your new appliance is particularly energy-efficient. Here you can find tips on how to save even more energy when using the appliance, and how to dispose of your appliance properly.

Saving energy

- During cooking, ensure that there is a sufficient supply of air so that the extractor hood can work efficiently and with a low level of operating noise.
- Adjust the fan speed to the intensity of the cooking fumes. Only use intensive mode where this is required. A lower fan speed means that less energy is consumed.
- If there are intensive cooking fumes, select a higher fan speed in good time. If cooking fumes have already spread in the kitchen, the extractor hood must be operated for longer.
- Switch off the extractor hood if you no longer require it.

- Switch off the lighting if you no longer require it.
- Clean and, if required, replace the filter at regular intervals in order to increase the effectiveness of the ventilation system and to prevent the risk of fire.

Environmentally-friendly disposal

Dispose of packaging in an environmentally-friendly manner.



This appliance is labelled in accordance with European Directive 2012/19/EU concerning used electrical and electronic appliances (waste electrical and electronic equipment - WEEE). The guideline determines the framework for the return and recycling of used appliances as applicable throughout the EU.

Operating mode

You can use this appliance in circulating-air mode.

Circulating-air mode



The air which is drawn in is cleaned by the grease filters and an activated carbon filter and conveyed back into the kitchen.

Note: To bind odours in circulating-air mode, you must install an activated carbon filter. The different options for operating the appliance in circulating-air mode can be found in the brochure. Alternatively, ask your dealer. The required accessories are available from specialist outlets, from customer service or from the Online Shop. The accessory numbers can be found at the end of the instructions for use.

Operating the appliance

Note: Switch on the extractor hood when you start cooking and switch it off again several minutes after you have finished cooking. This is the most effective way of removing the kitchen fumes.

Controls

Use the remote control to set and adjust the various different functions of your appliance.

Note: The remote control requires AAA/LR03/1.5 V batteries. Refer to the *Changing the batteries in the remote control* section for instructions on how to insert the batteries.

Note: Point as accurately as you can with the remote control to the infrared receiver on the extractor hood's control panel.

Note: Heat and penetrating moisture may damage the remote control. Never expose the remote control to intense heat or moisture.

Remote control

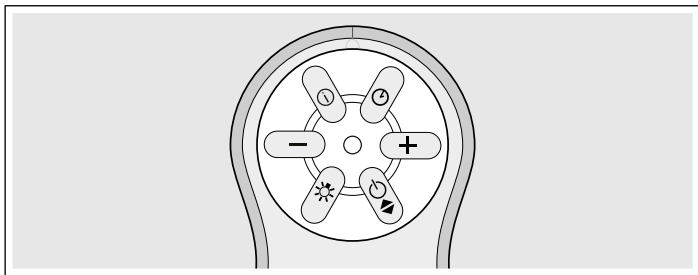

Operating buttons

Button	Explanation
⏻	Switches on the run-on function/intermittent function
+	Increases the power setting
⏻	Switches the extractor hood on and off
💡	Switches the lighting on and off
-	Reduces the power setting
ⓘ	Switches on intensive mode

Extractor hood's control panel

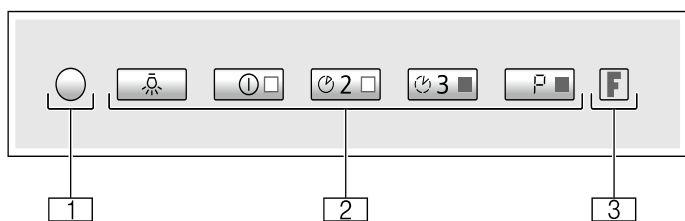

1	Infrared receiver
2	Operating buttons
3	Saturation indicator

Operating buttons

Button	Explanation
💡	Switches the lighting on and off
ⓘ	Switches off the extractor hood/switches on fan setting 1
⌚ 2	Switches on fan setting 2
⌚ 3	Switches on fan setting 3
P	Switches on intensive mode

Switching the appliance on and off

Note: Always adjust the setting according to the current conditions. To eliminate strong cooking smells, select a high fan setting.

Switching on the appliance

Press the ⏻ button on the remote control or the ⓘ button on the extractor hood's control panel.

The extractor hood starts at power setting 1.

The ⓘ button lights up.

Selecting the fan setting

Press the + or - button on the remote control or the ⓘ, ⌚ 2 or ⌚ 3 button on the extractor hood's control panel for the fan setting you require.

The ⓘ button will light up when power setting 1 has been selected.

The ⓘ and ⌚ 2 buttons will light up when power setting 2 has been selected.

The ⓘ, ⌚ 2 and ⌚ 3 buttons will light up when power setting 3 has been selected.

Switching off the appliance

Press the ⏻ button on the remote control or the ⓘ button on the extractor hood's control panel.

Intensive setting

Activate intensive mode to eliminate strong smells and odours. In this mode, the extractor hood operates at its maximum fan setting for a short time. After a short time, it automatically switches back to a low setting.

Switching on

Press the ⓘ button on the remote control or the P button on the extractor hood's control panel.

The ⓘ, ⌚ 2 and ⌚ 3 buttons will light up and the P button will flash. Intensive mode is activated.

Note: After 6 minutes, the extractor hood automatically switches back to the fan setting that was set beforehand.

Switching off



Press the ⓘ button on the remote control or the ⓘ button on the extractor hood's control panel.

Intermittent mode

The intermittent function automatically switches on the extractor hood for 10 minutes every hour. After 24 hours, this function switches itself off again.



Note: If intensive mode or the run-on function has been activated, the intermittent function will not be available.

Switching on

Press and hold the  button on the remote control or the  3 button on the extractor hood's control panel.

The  button on the extractor hood's control panel flashes. The intermittent function is now on. The extractor hood starts at power setting 1.

Switching off

Press the  button on the remote control or the  button on the extractor hood's control panel.

This switches off the intermittent function.



Run-on function

The run-on function allows the extractor hood to continue running for a few minutes after it has been switched off. This eliminates any remaining cooking smells. The extractor hood will then switch itself off automatically.

Switching on



Note: If intensive mode or intermittent operation has been activated, the run-on function will not be available.

1. Select the power setting.

2. Press the  button on the remote control or press and hold the  2 button on the extractor hood's control panel.

The button for the selected power setting will flash on the extractor hood's control panel. The fan will continue to run at this setting for 30 minutes and then switch off automatically once this time has elapsed. If the lighting has been switched on, this will also be switched off once the run-on time has elapsed.

Switching off



Press the  or  button on the remote control or the  button on the extractor hood's control panel.

This will deactivate the run-on function immediately.

Lighting



The lighting will work even if the extractor hood is switched off.

Switching on



Press the  button on the remote control or the  button on the extractor hood's control panel.

The  button on the extractor hood's control panel will light up.

Reducing the brightness

Press and hold the  button on the remote control or the  button on the extractor hood's control panel until the brightness has been reduced to the required level.

Switching off

Press the  button on the remote control or the  button on the extractor hood's control panel.

Cleaning and maintenance

Risk of burns!

The appliance becomes hot during operation. Allow the appliance to cool down before cleaning.

Risk of electric shock!

Penetrating moisture may result in an electric shock. Clean the appliance using a damp cloth only. Before cleaning, pull out the mains plug or switch off the circuit breaker in the fuse box.

Risk of electric shock!

Do not use any high-pressure cleaners or steam cleaners, which can result in an electric shock.

Cleaning agents

To ensure that the different surfaces are not damaged by using the wrong cleaning agent, observe the information in the table. Do not use any of the following:

- Harsh or abrasive cleaning agents,
- Cleaning agents with a high alcohol content,
- Hard scouring pads or cleaning sponges,
- High-pressure cleaners or steam cleaners.

Wash new sponge cloths thoroughly before use.

Follow all instructions and warnings included with the cleaning agents.

Area	Cleaning agent
Stainless steel	Hot soapy water: Clean with a dish cloth and then dry with a soft cloth. Clean stainless steel surfaces in the grind direction only. Special stainless steel cleaning products are available from our after-sales service or from specialist retailers. Apply a very thin layer of the cleaning product with a soft cloth.
Painted surfaces	Hot soapy water: Clean using a damp dish cloth and dry with a soft cloth/towel. Do not use any stainless steel cleaners.
Aluminium and plastic	Glass cleaner: Clean with a soft cloth.
Glass	Glass cleaner: Clean with a soft cloth. Do not use a glass scraper.
Controls	Hot soapy water: Clean using a damp dish cloth and dry with a soft cloth/towel. Risk of electric shock caused by penetrating moisture. Risk of damage to the electronics from penetrating moisture. Never clean operating controls with a wet cloth. Do not use any stainless steel cleaners.

Saturation display

When the metal grease filters or activated charcoal filters are saturated, the corresponding symbol will flash:

- **Metal grease filter:** The F indicator and the Ⓛ button light up
- **Activated charcoal filter:** The F indicator and the Ⓜ 3 button light up
- **Metal grease filter and activated charcoal filter:** The F indicator and the Ⓛ and Ⓜ 3 buttons light up

Do not wait any longer to clean the metal grease filters or replace or regenerate the activated charcoal filters.

Removing and installing the filter

The filter must be serviced regularly in order to guarantee efficient filtration of odours and grease.

Metal grease filter

The metal grease filters must be cleaned every 100 operating hours or at least every two months.

⚠ Risk of fire!

Grease deposits in the grease filter may catch fire.

Clean the grease filter at least every 2 months.

Never operate the appliance without the grease filter.

Activated charcoal filters

The activated charcoal filters must be replaced or regenerated regularly. The saturation indicator on your appliance will tell you how frequently this needs to be done.

Removing metal grease filter

The metal grease filters filter the grease out of kitchen steam. To keep them in good working order, the filters should be cleaned at least every two months.

1. Pull the filter cover downwards.

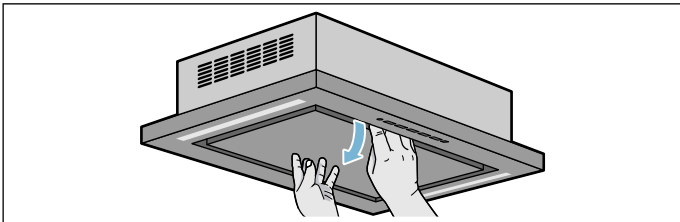

Note: Make sure that the filter cover does not swing down suddenly.

2. Open the locking mechanism on the metal grease filter and remove the filter from the holder.

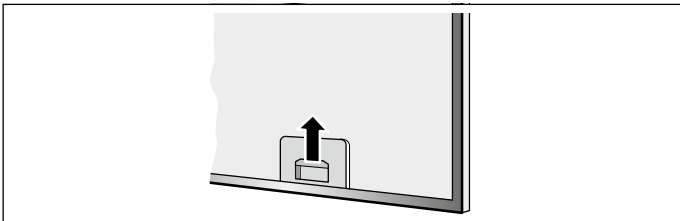

Notes

- When you do this, take hold of the metal grease filter from underneath with your other hand. Make sure that the metal grease filter does not fall and damage the hob.
- Fat may collect in the bottom of the filter holder. Hold the filter holder at an angle to prevent fat from dripping out.
- Do not remove the cover plate from the inside of the appliance.

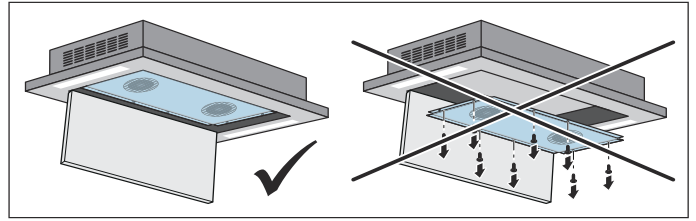

3. Remove the activated charcoal filter from the metal grease filter.
4. Clean the metal grease filter and the filter cover.
5. After removing the filters, clean the inside of the appliance.

Replacing or regenerating the activated charcoal filters

Activated charcoal filters trap the odour-causing compounds in cooking smells. They are only used for circulating-air mode.

Notes

- The activated charcoal filters are included with the appliance. When the activated charcoal filters need to be replaced, they can be obtained from specialist retailers, from our after-sales service or from our online shop.
- Only use genuine replacement filters. This will ensure that the appliance performs optimally.

1. Remove the holder on the rear of the metal grease filter and take out the activated charcoal filter.

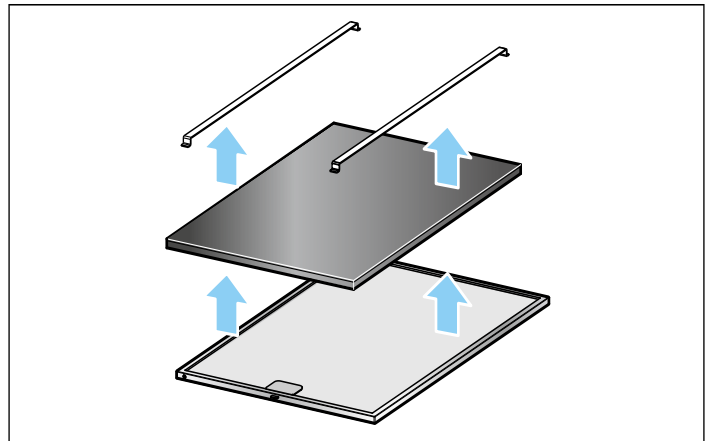

2. Clean the appliance.
3. Clean the metal grease filters.
4. Secure the new activated charcoal filter using the holder on the rear of the metal grease filter.

Regenerating the activated charcoal filter

Note: The activated charcoal filter can be regenerated up to four times.

1. Remove the activated charcoal filter.
2. Heat the activated charcoal filter in an oven heated to 100 °C for 60 minutes.
3. Leave the activated charcoal filter to cool down.
4. Fit the activated charcoal filter.

Cleaning the metal mesh grease filters

Notes

- Do not use any aggressive, acidic or alkaline cleaning agents.
- When cleaning the metal mesh grease filters, also clean the holder for the metal mesh grease filters in the appliance using a damp cloth.
- The metal mesh grease filters can be cleaned in the dishwasher or by hand.

By hand:

Note: You can use a special grease solvent for stubborn dirt. It can be ordered via the Online Shop.

- Soak the metal mesh grease filters in a hot soapy solution.
- Clean the filters with a brush and then rinse them thoroughly.
- Leave the metal mesh grease filters to drain.

In the dishwasher:

Note: If the metal mesh grease filters are cleaned in the dishwasher, slight discolouration may occur. This has no effect on the function of the metal mesh grease filters.

- Do not clean heavily soiled metal mesh grease filters together with utensils.
- Place the metal mesh grease filters loosely in the dishwasher. The metal mesh grease filters must not be wedged in.

Installing the metal mesh grease filter

1. Insert metal grease filter.
2. Fold the metal grease filter up and click it into place.
3. Fold the filter cover upwards.

Note: Make sure that the filter cover closes properly.

Resetting the saturation displays

Once you have cleaned or replaced the relevant filters, reset the saturation indicator to stop the symbols from flashing.

Make sure that the extractor hood and the lighting have been switched off.

Press and hold the  button until indicator F flashes three times.

This resets the saturation indicators.

Trouble shooting

Malfunctions often have simple explanations. Please read the following notes before calling the after-sales service.



Risk of electric shock!

Incorrect repairs are dangerous. Repairs may only be carried out and damaged power cables replaced by one of our trained after-sales technicians. If the appliance is defective, unplug the appliance from the mains or switch off the circuit breaker in the fuse box. Contact the after-sales service.

LED lights

Defective LED lights may be replaced by the manufacturer, their after-sales service or a qualified technician (electrician) only.

Malfunction table

Problem	Possible cause	Solution
The appliance does not work	The plug is not plugged into the mains	Connect the appliance to the power supply
	Power cut	Check whether other kitchen appliances are working
	The fuse is faulty	Check in the fuse box to make sure that the fuse for the appliance is in working order
The lighting does not work.	The LED lights are defective.	Call the after-sales service.
The button illumination does not work.	The control unit is faulty.	Call the after-sales service.
The F indicator and the  button light up or the F indicator and the  3 button light up.	The grease filter or the activated charcoal filter is saturated.	Clean the filter or regenerate or replace the activated charcoal filter; see the <i>Cleaning and maintenance</i> section.

Replacing the batteries in the remote control

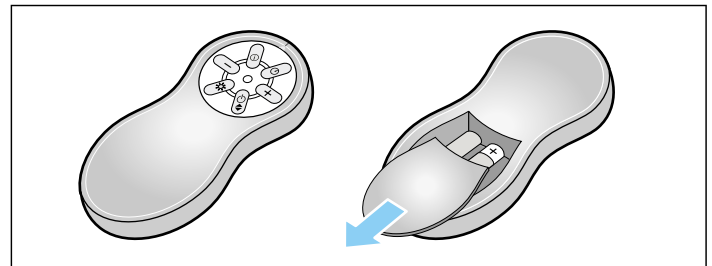

1. Push in the lug.
2. Remove the cover.
3. Remove the batteries.
4. Correctly insert the new batteries (AAA/LR03/1.5 V).

Note: Dispose of flat or faulty batteries in accordance with local regulations.

Note: Do not dispose of batteries along with general household waste.

After-sales service

Our after-sales service is there for you if your appliance needs to be repaired. We will always find the right solution in order to avoid unnecessary visits from a service technician.

When calling us, please give the product number (E no.) and the production number (FD no.) so that we can provide you with the correct advice. The rating plate with these numbers can be found inside the appliance (remove the metal mesh grease filter to gain access).

You can make a note of the numbers of your appliance and the telephone number of the after-sales service in the space below to save time should it be required.

E no.	FD no.
-------	--------

After-sales service 

Please be aware that a visit by an after-sales engineer will be charged if a problem turns out to be the result of operator error, even during the warranty period.

Please find the contact data of all countries in the enclosed customer service list.

To book an engineer visit and product advice

GB 0344 892 8989

Calls charged at local or mobile rate.

IE 01450 2655

0.03 € per minute at peak. Off peak 0.0088 € per minute.

Rely on the professionalism of the manufacturer. You can therefore be sure that the repair is carried out by trained service technicians who carry original spare parts for your appliances.

Special accessories

Accessories	Order number
Activated charcoal filter	Z54CP00X0



Constructa-Neff
Vertriebs-GmbH
Carl-Wery-Straße 34
D-81739 München
GERMANY

Register your product online

www.neff-international.com



9001158502

960307