

T58..6BN0, T58P.6BX0

**Flex induction cooktop with  
integrated ventilation system**

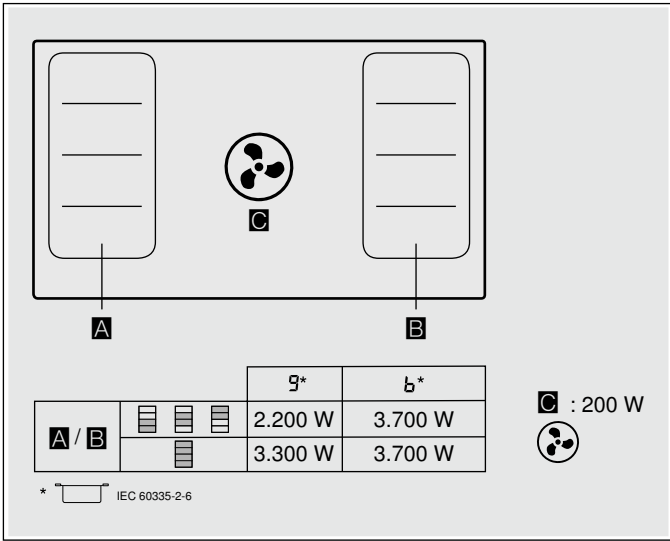

en Instruction manual





# Table of contents

	<b>Intended use</b> . . . . .	<b>4</b>		<b>PowerBoost function</b> . . . . .	<b>24</b>
	<b>Important safety information</b> . . . . .	<b>5</b>	Activating . . . . .	24	
	<b>Causes of damage</b> . . . . .	<b>8</b>	Deactivating . . . . .	24	
Overview . . . . .	8			<b>ShortBoost function</b> . . . . .	<b>25</b>
	<b>Environmental protection</b> . . . . .	<b>9</b>	Recommendations for use . . . . .	25	
Saving energy . . . . .	9		Activating . . . . .	25	
Environmentally-friendly disposal . . . . .	9		Deactivating . . . . .	25	
	<b>Induction cooking</b> . . . . .	<b>9</b>		<b>Keep warm function</b> . . . . .	<b>26</b>
Advantages of induction cooking . . . . .	9		Activation . . . . .	26	
Cookware . . . . .	9		Deactivation . . . . .	26	
	<b>Getting to know your appliance</b> . . . . .	<b>11</b>		<b>Frying Sensor</b> . . . . .	<b>26</b>
Your new appliance . . . . .	11		Advantages when frying . . . . .	26	
Special accessories . . . . .	11		For frying with the frying sensor . . . . .	26	
The control panel . . . . .	12		Temperature settings . . . . .	27	
The hotplates . . . . .	12		Table . . . . .	27	
Residual heat indicator . . . . .	12		Setting procedure . . . . .	29	
Operating modes . . . . .	13			<b>Childproof lock</b> . . . . .	<b>29</b>
	<b>Before using for the first time</b> . . . . .	<b>13</b>	Activating and deactivating the childproof lock . . . . .	29	
Initial use . . . . .	13		Childproof lock . . . . .	29	
	<b>Twist-Pad with Twist knob</b> . . . . .	<b>15</b>		<b>Wipe protection</b> . . . . .	<b>30</b>
Remove the twist knob . . . . .	15			<b>Automatic safety cut-out</b> . . . . .	<b>30</b>
Storing the twist knob . . . . .	15			<b>Basic settings</b> . . . . .	<b>31</b>
Operating the hob without the twist knob . . . . .	15		To access the basic settings: . . . . .	32	
	<b>Operating the appliance</b> . . . . .	<b>16</b>		<b>Energy consumption indicator</b> . . . . .	<b>33</b>
Switching the hob on and off . . . . .	16			<b>Cookware check</b> . . . . .	<b>33</b>
Setting a hotplate . . . . .	16			<b>Cleaning</b> . . . . .	<b>34</b>
Switching the ventilation system on and off . . . . .	16		Cleaning agents . . . . .	34	
Intensive setting . . . . .	17		Components to clean . . . . .	35	
Automatic start . . . . .	17		Hob surround (only on appliances with hob surrounds) . . . . .	35	
Automatic mode with sensor control . . . . .	18		Hob . . . . .	35	
Run-on function . . . . .	18		Ventilation system . . . . .	35	
Chef's recommendations . . . . .	18		Cleaning the overflow container . . . . .	38	
	<b>Flex Zone</b> . . . . .	<b>21</b>	Twist knob . . . . .	38	
Advice on using cookware . . . . .	21			<b>Frequently Asked Questions (FAQ)</b> . . . . .	<b>39</b>
As two independent hotplates . . . . .	21			<b>Trouble shooting</b> . . . . .	<b>41</b>
As a single hotplate . . . . .	21				
	<b>Move function</b> . . . . .	<b>22</b>			
Activation . . . . .	22				
Deactivating . . . . .	22				
	<b>Time-setting options</b> . . . . .	<b>23</b>			
Programming the cooking time . . . . .	23				
The kitchen timer . . . . .	23				
Stopwatch function . . . . .	24				

 <b>Customer service</b> .....	<b>42</b>
E number and FD number .....	42
 <b>Test dishes</b> .....	<b>43</b>

---

Additional information on products, accessories, replacement parts and services can be found at [www.neff-international.com](http://www.neff-international.com) and in the online shop [www.neff-eshop.com](http://www.neff-eshop.com)

---

## Intended use

Read these instructions carefully. Please keep the instruction and installation manual, as well as the appliance certificate, in a safe place for later use or for subsequent owners.

Check the appliance after removing it from the packaging. If it has suffered any damage in transport, do not connect the appliance, contact the Technical Assistance Service and provide written notification of the damage caused, otherwise you will lose your right to any type of compensation.

This appliance must be installed according to the installation instructions included.

This appliance is intended for private domestic use and the household environment only. The appliance must only be used for the preparation of food and beverages. The cooking process must be supervised. A short cooking process must be supervised without interruption. Only use the appliance in enclosed spaces.

This appliance is intended for use up to a maximum height of 2000 metres above sea level.

Do not use covers. These can cause accidents, due to overheating, catching fire or materials shattering, for example.

Do not use inappropriate child safety shields or hob guards. These can cause accidents.

This appliance is not intended for operation with an external clock timer or a remote control.

This appliance may be used by children over the age of 8 years old and by persons with reduced physical, sensory or mental capabilities or by persons with a lack of experience or knowledge if they are supervised or are instructed by a person responsible for their safety how to use the appliance safely and have understood the associated hazards.

Children must not play with, on, or around the appliance. Children must not clean the appliance or carry out general maintenance unless they are at least 8 years old and are being supervised.

Keep children below the age of 8 years old at a safe distance from the appliance and power cable.

When using the cooking functions, set the hotplate on which you have placed the saucepan with the temperature sensor.

We advise that you exercise caution using or standing near an induction hob while it is in operation, if you wear a pacemaker or a similar medical device. Consult your doctor or the device manufacturer concerning its conformity or any possible incompatibilities,

## Important safety information

The appliance can only be used safely if it is correctly installed according to the safety instructions. The installer is responsible for ensuring that the appliance works perfectly at its installation location.

Only a licensed professional may connect appliances without plugs. Damage caused by incorrect connection is not covered under warranty.

Dangerous or explosive materials and vapours must not be extracted.

Ensure that no small parts or liquids get into the appliance.

Check the appliance for damage after unpacking it. Do not connect the appliance if it has been damaged in transport.

This appliance is not intended for operation with an external clock timer or a remote control.

### **Warning – Danger of suffocation!**

Packaging material is dangerous to children. Never allow children to play with packaging material.

### **Warning – Danger of death!**

Risk of poisoning from flue gases that are drawn back in.

Always ensure adequate fresh air in the room if the appliance is being operated in exhaust air mode at the same time as room air-dependent heat-producing appliance is being operated.

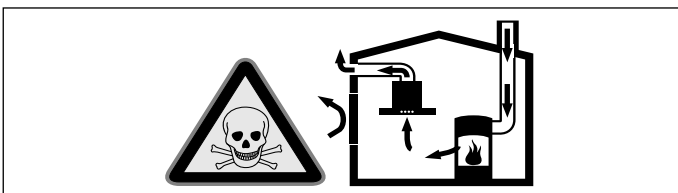

Room air-dependent heat-producing appliances (e.g. gas, oil, wood or coal-operated heaters, continuous flow heaters or water heaters) obtain combustion air from the room in which they are installed and discharge the exhaust gases into the open air through an exhaust gas system (e.g. a chimney).

In combination with an activated vapour extractor hood, room air is extracted from the kitchen and neighbouring rooms - a partial vacuum is produced if not enough fresh air is supplied. Toxic gases from the chimney or the extraction shaft are sucked back into the living space.

- Adequate incoming air must therefore always be ensured.
- An incoming/exhaust air wall box alone will not ensure compliance with the limit.

Safe operation is possible only when the partial vacuum in the place where the heat-producing appliance is installed does not exceed 4 Pa (0.04 mbar). This can be achieved when the air needed for combustion is able to enter through openings that cannot be sealed, for example in doors, windows, incoming/exhaust air wall boxes or by other technical means.

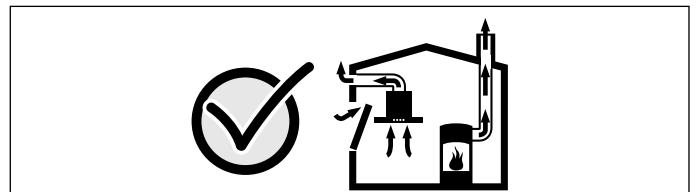

In any case, consult your responsible Master Chimney Sweep. He is able to assess the house's entire ventilation setup and will suggest the suitable ventilation measures to you.

Unrestricted operation is possible if the vapour extractor hood is operated exclusively in the circulating-air mode.

**⚠ Warning – Risk of fire!**

- Hot oil and fat can ignite very quickly. Never leave hot fat or oil unattended. Never use water to put out burning oil or fat. Switch off the hotplate. Extinguish flames carefully using a lid, fire blanket or something similar.
- The hotplates become very hot. Never place combustible items on the hob. Never place objects on the hob.
- The appliance gets hot. Do not keep combustible objects or aerosol cans in drawers directly underneath the hob.
- The hob switches off automatically and can no longer be operated. It may switch on unintentionally at a later point. Switch off the circuit breaker in the fuse box. Contact the after-sales service.
- Grease deposits in the grease filter may catch fire.

**Clean the grease filter at least once a month.**

Never operate the appliance without the grease filter.

- Fatty deposits in the filters may catch fire. Clean the appliance as described. Comply with the cleaning intervals. Never operate the appliance without the grease filter.
- Grease deposits in the grease filter may catch fire. Never work with naked flames close to the appliance (e.g. flambéing). Do not install the appliance near a heat-producing appliance for solid fuel (e.g. wood or coal) unless a closed, non-removable cover is available. There must be no flying sparks.

**⚠ Warning – Risk of burns!**

- The hotplates and surrounding area (particularly the hob surround, if fitted) become very hot. Never touch the hot surfaces. Keep children at a safe distance.
- The hotplate heats up but the display does not work. Switch off the circuit breaker in the fuse box. Contact the after-sales service.
- Metal objects on the hob quickly become very hot. Never place metal objects (such as knives, forks, spoons and lids) on the hob.
- The metal filter cover will get very hot very quickly if left on the hob. Never set the filter cover down on the hob. Do not place pots, pans or other hot objects on the filter cover.
- After each use, always turn off the hob at the main switch. Do not wait until the hob turns off automatically after the pan is removed.
- The accessible parts become very hot when in operation. Never touch hot parts. Keep children at a safe distance.

**⚠ Warning – Risk of electric shock!**

- Incorrect repairs are dangerous. Repairs may only be carried out and damaged power cables replaced by one of our trained after-sales technicians. If the appliance is defective, unplug the appliance from the mains or switch off the circuit breaker in the fuse box. Contact the after-sales service.
- Do not use any high-pressure cleaners or steam cleaners, which can result in an electric shock.
- A defective appliance may cause electric shock. Never switch on a defective appliance. Unplug the appliance from the mains or switch off the circuit breaker in the fuse box. Contact the after-sales service.
- Cracks or fractures in the glass ceramic may cause electric shocks. Switch off the circuit breaker in the fuse box. Contact the after-sales service.

**⚠ Warning – Electromagnetic hazards!**

- This appliance complies with safety and electromagnetic compatibility standards. However, people with pacemakers or insulin pumps must refrain from using this appliance. It is impossible to ensure that all of these devices available on the market comply with current electromagnetic compatibility standards, and that interference which may prevent the device from working correctly will not occur. It is also possible that people with other types of devices, such as a hearing aids, could experience some discomfort.
- The wireless temperature sensor is magnetic. The magnetic elements in it may damage electronic implants, e.g. pacemakers or insulin pumps. People fitted with electronic implants should therefore not carry the temperature sensor in their pockets and always keep it at least 10 cm away from their pacemaker or similar medical device.

**⚠ Warning – Risk of injury!**

- When cooking in a bain marie, the hob and cooking container could shatter due to overheating. The cooking container in the bain marie must not directly touch the bottom of the water-filled pot. Only use heat-resistant cookware.
- Saucepans may suddenly jump due to liquid between the pan base and the hotplate. Always keep the hotplate and saucepan bases dry.
- Components inside the appliance may have sharp edges. Wear protective gloves.
- Cookware and cooktops become very hot. Never reach across the hot cooktop or take hold of hot cookware.
- The battery in the wireless temperature sensor may become damaged or explode if it gets too hot. Remove the sensor from the hob after cooking and do not store it near sources of heat.
- The temperature sensor may be very hot when removing it from the saucepan. Wear oven gloves or use a tea towel to remove it.
- Unsuitable woks may cause accidents. Only use woks supplied by the manufacturer (available as optional accessories).

**⚠ Warning – Malfunction risk!**

The hob is equipped with a fan in the lower section. If there is a drawer under the hob it should not be used to store small objects or paper, since they could damage the fan or interfere with the cooling if they are sucked into it.

There should be a minimum of 2 cm between the contents of the drawer and fan intake.

## Causes of damage

### Caution!

- Rough pan bases may scratch the hob.
- Avoid leaving empty pots and pans on the hotplate. Doing so may cause damage.
- Do not place hot pans on the control panel, the indicator area, or the hob frame. Doing so may cause damage.
- Hard or pointed objects dropped on the hob may damage it.
- Aluminium foil and plastic containers will melt if placed on the hotplate while it is hot. The use of laminated sheeting is not recommended on the hob.
- Risk of damage due to corrosion. Always switch on the appliance while cooking to avoid condensation. Condensate can produce corrosion damage.
- Risk of damage due to ingress of moisture into the electronic circuitry. Never clean controls with a wet cloth.
- Surface damage due to incorrect cleaning. Clean stainless steel surfaces in the direction of the grain only. Do not use stainless-steel cleaning agents on the controls.
- Surface damage due to strong or abrasive cleaning agents. Never use strong and abrasive cleaning agents.

### Overview

You will find the most frequently caused damage in the following table:

Damage	Cause	Measure
Stains	Boiled over food.	Remove boiled over food immediately with a glass scraper.
	Unsuitable cleaning agent.	Only use cleaning agents that are suitable for this type of hob.
Scratches	Salt, sugar and sand.	Do not use the hob as a work surface or storage space.
	Cookware with rough bases scratch the hob.	Check the cookware.
Discolouration	Unsuitable cleaning agent.	Only use cleaning agents that are suitable for this type of hob.
	Pan abrasion.	Lift pots and pans when moving them.
Chips	Sugar, food with a high sugar content.	Remove boiled over food immediately with a glass scraper.



## Environmental protection

In this section, you can find information about saving energy and disposing of the appliance.

### Saving energy

- Always place suitable lids on saucepans. Cooking without a lid consumes significantly more energy. Use a glass lid so that you can see into the pan without having to lift the lid.
- Use pots and pans with flat bases. Uneven bases increase the energy consumption.
- The base diameter of pots and pans should be the same size as the hotplate. Please note: Cookware manufacturers often specify the diameter of the top of the saucepan, which is usually larger than the diameter of the base of the saucepan.
- Use small saucepans for small quantities. Using a large saucepan with little in it consumes a lot of energy.
- Cook with only a little water. This will save energy and preserve the vitamins and minerals in vegetables.
- Switch to a lower heat setting in good time. This will save energy.
- During cooking, ensure that there is a sufficient supply of air to enable the extractor hood to work efficiently and with a low level of operating noise.
- Adjust the fan speed to the amount of steam produced during cooking. Only use intensive mode when required. The lower the fan speed, the less energy is consumed.
- If cooking produces large amounts of steam, select a higher fan speed in good time. If the cooking steam has already spread around the kitchen, the extractor hood will need to be operated for longer.
- Switch the appliance off when you are not using it.
- Clean and (if required) replace the filter at regular intervals in order to increase the effectiveness of the ventilation system and to prevent the risk of fire.

### Environmentally-friendly disposal

Dispose of packaging in an environmentally-friendly manner.



This appliance is labelled in accordance with European Directive 2012/19/EU concerning used electrical and electronic appliances (waste electrical and electronic equipment - WEEE). The guideline determines the framework for the return and recycling of used appliances as applicable throughout the EU.

## Induction cooking

### Advantages of induction cooking

Induction cooking is very different from traditional cooking methods, as heat builds up directly in the item of cookware. This offers numerous advantages:

- Saves time when boiling and frying.
- Saves energy.
- Easier to care for and clean. Spilled food does not burn on as quickly.
- Heat control and safety – the hob increases or decreases the heat supply as soon as the user changes the setting. The induction hotplate stops the heat supply as soon as the cookware is removed from the hotplate, without having to switch it off first.

### Cookware

Only use ferromagnetic cookware for induction cooking, such as:

- Cookware made from enamelled steel
- Cookware made from cast iron
- Special induction-compatible cookware made from stainless steel.

You can check whether the cookware is suitable for induction cooking.

To achieve a good cooking result, the ferromagnetic area on the base of the pan should match the size of the hotplate. If a hotplate does not detect an item of cookware, try placing it on another hotplate with a smaller diameter.

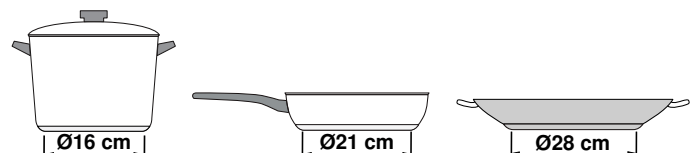

If the only hotplate being used is the flexible cooking zone, larger cookware that is particularly suited to this zone can be used. You can find information on positioning cookware in the section on .



Some induction cookware does not have a fully ferromagnetic base:

- If the base of the cookware is only partially ferromagnetic, only the area that is ferromagnetic will heat up. This may mean that heat will not be distributed evenly. The non-ferromagnetic area may not heat up to a sufficient temperature for cooking.

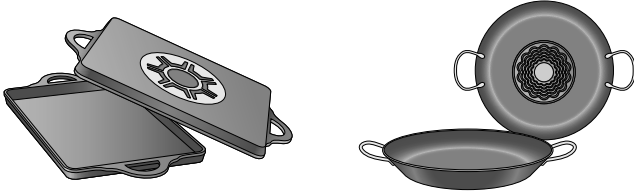

- The ferromagnetic area will also be reduced if the material from which the base of the cookware is made contains aluminium, for example. This may mean that the cookware will not become sufficiently hot or even that it will not be detected.

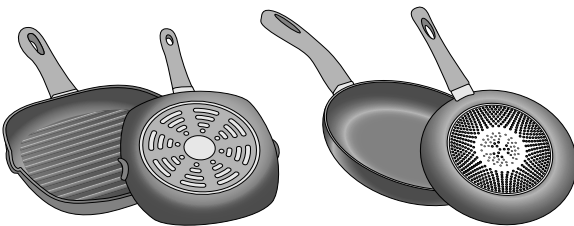

### Unsuitable pans

Never use diffuser hobs or pans made from:

- common thin steel
- glass
- earthenware
- copper
- aluminium

### Properties of the base of the cookware

The material(s) from which the base of the cookware is made can affect the cooking result. Using pots and pans made from materials that distribute heat evenly through them, such as stainless-steel pans with a three-layer base, saves time and energy.

Use cookware with a flat base; if the base of the cookware is uneven, this may impair the heat supply.

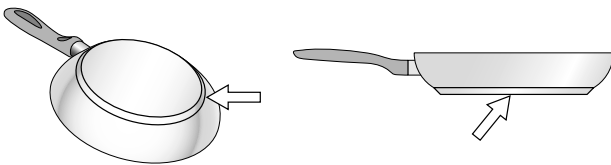

### Absence of pan or unsuitable size

If no pan is placed on the selected hotplate, or if it is made of unsuitable material or is not the correct size, the power level displayed on the hotplate indicator will flash. Place a suitable pan on the hotplate to stop the flashing. If this takes more than 90 seconds, the hotplate will switch off automatically.

### Empty pans or those with a thin base

Do not heat empty pans, nor use pans with a thin base. The hob is equipped with an internal safety system. However, an empty pan may heat up so quickly that the "automatic switch off" function may not have time to react and the pan may reach very high temperatures. The base of the pan could melt and damage the glass on the hob. In this case, do not touch the pan and switch the hotplate off. If it fails to work after it has cooled down, please contact the Technical Assistance Service.

### Pan detection

Each hotplate has a lower limit for pan detection. This depends on the diameter of the ferromagnetic area of the cookware and the material from which its base is made. For this reason, you should always use the hotplate that best matches the diameter of the base of the pan.

## Getting to know your appliance

You can find information on the dimensions and power of the hotplates in → *Page 2*

In this section, we will explain the indicators and controls. You will also find out about the various functions of your appliance.

### Your new appliance

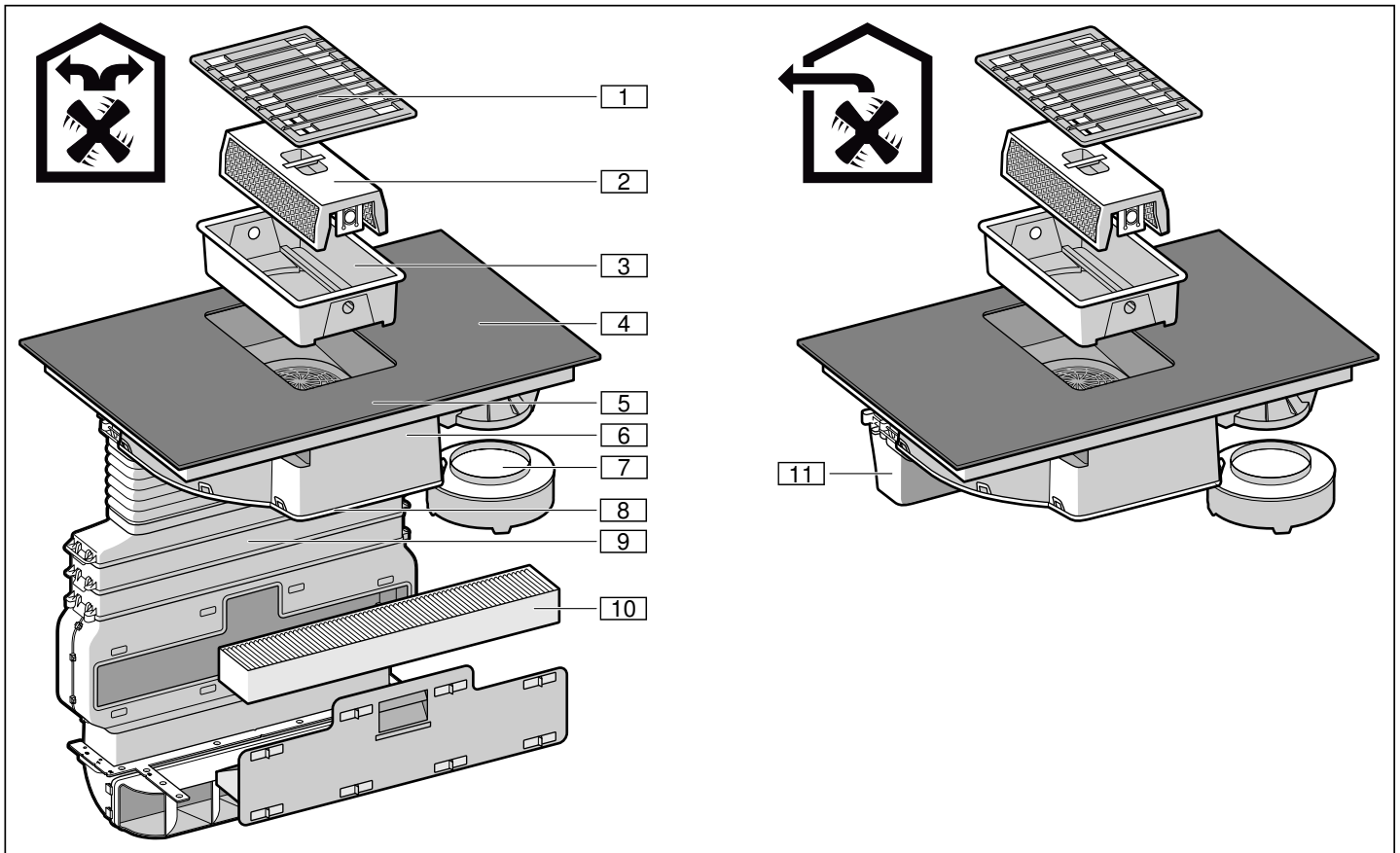

No.	Name
1	Filter cover
2	Metal grease filter
3	Container
4	Hob
5	Control panel
6	Fan housing
7	Overflow container
8	Housing cover
9	Piping*
10	Activated charcoal filter*
11	Exhaust pipe**
* in air recirculation mode only	
** in air extraction mode only	

### Special accessories

Extraction air set	Z8100X0
Air recirculation set	Z8200X0
Activated charcoal filter	Z8500X0

### Suitable cookware

There are pans that are optimally suited for the frying sensor function. They can be purchased from specialist retailers or through our technical after-sales service. Always quote the relevant reference number.

15 cm frying pan	Z9451X0
19 cm frying pan	Z9452X0
21 cm frying pan	Z9453X0

## The control panel

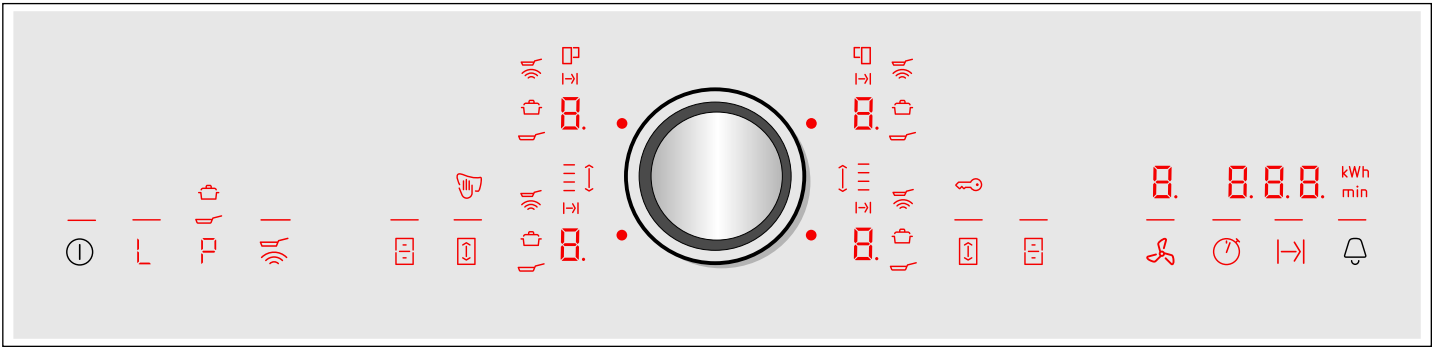

Controls	
	Switch the appliance on and off
	Switch on the keep-warm function
	Switch on the PowerBoost and ShortBoost functions
	Switch on the frying sensor
	Switch on the flexible cooking zone
	Activate the Move function
	Switch between the settings area on the hob and the ventilation system/set the ventilation system/switch on intensive mode and automatic start for the ventilation system
	Switch on the stopwatch function
	Programme the cooking time
	Programme the kitchen timer/switch on the childproof lock

Displays	
	Operating status
	Heat settings/fan speeds
	Residual heat
	Timer function

Displays	
	The control panel is locked for cleaning purposes
	PowerBoost and ShortBoost function/ intensive mode for ventilation
	Automatic mode with sensor control for ventilation/ automatic function with sensor-controlled run-on
	PowerBoost function
	ShortBoost function
	Keep-warm function
	Childproof lock
	Frying sensor
	Set the cooking time
	Flexible cooking zone
	Move function
<b>min</b>	Time display
<b>kWh</b>	Energy consumption

### Controls

Touching a symbol activates the respective function.

**Note:** Always keep the control panel clean and dry. Moisture can prevent it from working properly.

## The hotplates

Hotplate		
	Simple hotplate	Use cookware that is a suitable size
	Flexible cooking zone	See section → "Flex Zone"
Only use cookware that is suitable for induction cooking; see section → "Induction cooking"		

### Residual heat indicator

The hob has a residual heat indicator for each hotplate. This indicates that a hotplate is still hot. Do not touch a hotplate while the residual heat indicator is lit up.

The following are shown depending on the amount of residual heat:

- Display **H**: High temperature
- Display **h**: Low temperature

If you remove the cookware from the hotplate during cooking, the residual heat indicator and the selected heat setting will flash alternately.

When the hotplate is switched off, the residual heat indicator will light up. Even after the hob has been switched off, the residual heat indicator will stay lit for as long as the hotplate is still warm.

## Operating modes

This appliance can be used in exhaust-air mode or circulating-air mode.

### Exhaust air mode



The air which is drawn in is cleaned by the grease filters and conveyed to the exterior by a pipe system.

**Note:** The exhaust air must not be conveyed into a functioning smoke or exhaust gas flue or into a shaft which is used to ventilate installation rooms which contain heat-producing appliances.

- Before conveying the exhaust air into a non-functioning smoke or exhaust gas flue, obtain the consent of the heating engineer responsible.
- If the exhaust air is conveyed through the outer wall, a telescopic wall box should be used.

### Circulating-air mode



The air which is drawn in is cleaned by the grease filters and an activated carbon filter and conveyed back into the kitchen.

**Note:** To bind odours in circulating-air mode, you must install an activated carbon filter. The different options for operating the appliance in circulating-air mode can be found in the brochure. Alternatively, ask your dealer. The required accessories are available from specialist outlets, from customer service or from the Online Shop.

## Before using for the first time

Please read the following information before using the appliance for the first time:

Clean the appliance and all accessory parts thoroughly.

Before you can use your new appliance, you must apply certain settings.

### Initial use

**Note:** When it is delivered, the appliance is preset to air recirculation mode.

Possible settings:

- In air recirculation mode, if  $\llcorner 17$  is displayed, the value  $0$  (factory setting) is set.
- In air extraction mode, if  $\llcorner 17$  is displayed, the value  $1$  is set.

### Switching over the display for exhaust air mode

For air extraction mode, the electronic controller's display must be switched accordingly to the basic settings.

1. Check whether the appliance is connected and switched off.
2. Switch on the appliance.
3. Within the next 10 seconds, press and hold the  symbol for approximately four seconds. The first four displays provide product information. Turn the twist knob to view the individual displays.

Product information	Display screen
After-sales service index (ASSI)	01
Production number	Fd
Production number 1	95.
Production number 2	05

4. Touch the  symbol again to access the basic settings.  $\llcorner 1$  and  $0$  light up as a presetting in the displays.



5. Touch the  symbol repeatedly until  $\llcorner 17$  is displayed.

en Before using for the first time

6. Use the twist knob to select the **i** setting.



7. Touch the  symbol for at least four seconds. This saves the settings.
8. Use the main switch in order to exit the basic settings.

The display of the electronic controller is switched to air extraction mode.



### Switching over the display for circulating-air mode

When it is delivered, the appliance is set to air recirculation mode.

If the settings have been changed, proceed as follows to set the display for the electronic controller in the basic settings for air recirculation mode.

1. Check whether the appliance is connected and switched off.
2. Switch on the appliance.
3. Within the next 10 seconds, press and hold the  symbol for approximately 4 seconds. The first four displays provide product information. Turn the twist knob to view the individual displays.

Product information	Display screen
After-sales service index (ASSI)	01
Production number	Fd
Production number 1	95.
Production number 2	05

4. Touch the  symbol again to access the basic settings. **c i** and  light up as a presetting in the displays.



5. Touch the  symbol repeatedly until **c i7** is displayed.

6. Use the twist knob to select the  setting.



7. Touch the  symbol for at least four seconds. This saves the settings.
8. Use the main switch in order to exit the basic settings.

The display of the electronic controller is switched to air recirculation mode.

## Twist-Pad with Twist knob

The twistpad is the area in which you can use the twist knob to select the hotplates and heat settings. The twist knob automatically centres itself in the twistpad area.

The twist knob is magnetic and is placed on top of the twistpad. To activate a hotplate, touch the twist knob at the level for the required hotplate. Turning the twist knob selects the heat setting.

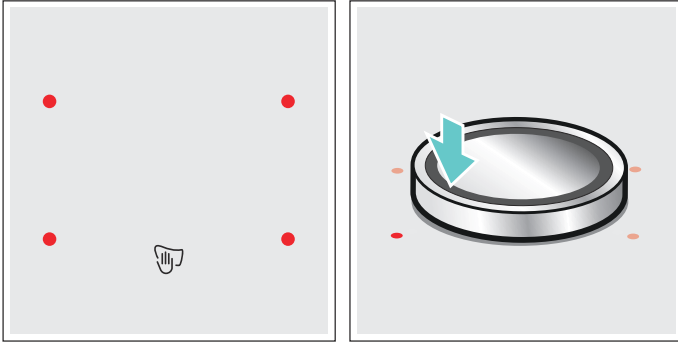

Position the twist knob on the twist pad so that it is in the centre of the indicators which delimit the twist pad area.

**Note:** Even if the twist knob is not entirely central, this will not under any circumstances affect how the twist knob works.

### Remove the twist knob.

If the twist knob is removed, the "Lock control panel for cleaning" function is activated.

The twist knob can be removed during cooking. The "Lock control panel for cleaning" function is activated for 35 seconds. If the twist knob is not placed back in position before this time elapses, the hob switches off.

### Warning – Risk of fire!

If during this 35 seconds a metallic object is placed in the twistpad area, the hob may continue to heat up. Therefore, always switch off the hob using the main switch.

### Storing the twist knob





A strong magnet is located inside of the twist knob. Keep the twist knob away from magnetic data carriers such as credit cards and cards with magnetic strips. Otherwise, these data carriers may be damaged beyond repair.

The magnet could also cause faults on televisions and screens.

**Note:** The twist knob is magnetic. Metal particles stuck to the bottom could scratch the surface of the hob. Always clean the twist knob thoroughly.

## Operating the hob without the twist knob

The hob can also be operated without the twist knob:

1. Switch on the hob using the main switch.
2. Within the next 5 seconds, simultaneously touch and hold the  and  symbols for 4 seconds. An audible signal will sound.
3. Touch the  symbol repeatedly until the indicator for the required hotplate lights up.
4. Then set the required heat setting using the  or  symbol.

The hotplate has now been activated.

### Notes

- The timer function cannot be activated without the twist knob.
- The twist knob can be placed back on the twistpad at any time.

## Operating the appliance

This chapter explains how to set a hotplate. The table shows heat settings and cooking times for various meals.

### Warning – Risk of burns!

The metal filter cover will get very hot very quickly if left on the hob. Never set the filter cover down on the hob. Do not place pots, pans or other hot objects on the filter cover.

**Note:** Switch on the extractor hood when you start cooking and switch it off again several minutes after you have finished cooking. This is the most effective way of removing the kitchen fumes.

### Switching the hob on and off

The main switch is used to switch the hob on and off.

To switch on: Touch the  symbol. The display above the main switch lights up. The hob is ready to use.

To switch off: Touch the  symbol until the display above the main switch goes out. All hotplates are switched off. The residual heat indicator remains lit until the hotplates have cooled down sufficiently.

#### Notes

- The hob will automatically switch itself off if all hotplates have been switched off for more than 30 seconds and the ventilation system is off.
- The selected settings are stored for 4 seconds after the hob has been switched off. If you switch it back on during this time, the hob will operate using the stored settings.

### Setting a hotplate

Set the required heat setting using the twist knob.

Heat setting 1 = lowest setting.

Heat setting 9 = highest setting.

Every heat setting has an intermediate setting. This is marked with a dot.

### Selecting a hotplate and heat setting

The hob must be switched on.

1. Select the hotplate. To do this, touch the twist knob in the appropriate area for the required hotplate.
2. Within the next 10 seconds, turn the twist knob until the required heat setting appears in the heat setting display.

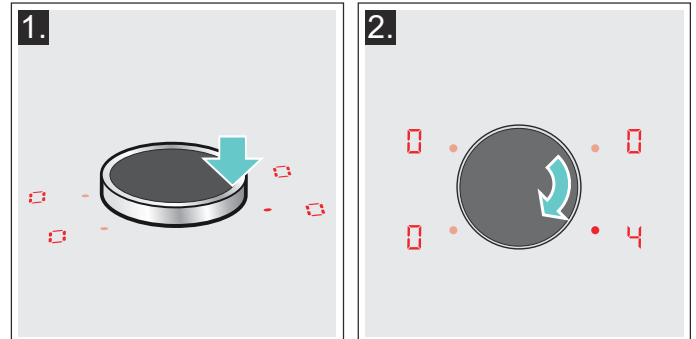

The heat setting is set.

### Changing the heat setting

Select the hotplate and change the heat setting using the twist knob.

### Switching off the hotplate

Select the hotplate and turn the twist knob until  appears. The hotplate switches itself off and the residual heat indicator lights up.

#### Notes

- If no pan has been placed on the hotplate, the selected power level flashes. After a certain time has elapsed, the hotplate switches off.
- If a pan has been placed on the hotplate before switching on the hob, it will be detected within 20 seconds of pressing the main switch and the hotplate will be selected automatically. Once detected, select the power level within the next 20 seconds or the hotplate will switch off. If more than one pan is placed on the hob, only one will be detected when switching it on.

### Switching the ventilation system on and off



**Note:** Always adjust the setting according to the current conditions. To eliminate strong cooking smells, select a high fan setting.

**Note:** If no metal grease filter is available, the ventilation system cannot be switched on. Insert the metal grease filter. The hob functions are also available if there is no metal grease filter. → "Cleaning" on page 34

**Note:** Do not obstruct the ventilation openings. Do not place objects on the filter cover, as this will reduce the power of the ventilation system.



## Switching on the ventilation system

**Note:** If the  symbol is not available, insert the metal grease filter correctly. → "Cleaning" on page 34  
The  symbol is available. The ventilation system can be switched on.

1. Touch the  symbol.  
The ventilation system will start at fan setting **2**. The fan setting that is selected will be shown on the display panel.

### Notes

- Heat settings cannot be changed while the ventilation system fan settings are being configured.
  - During a period of a few seconds, a fan setting for the ventilation system can be selected. The rotary knob can then be used to set the heat settings again.
2. Use the rotary knob to select the required setting.  
The fan setting that is selected will be shown on the display panel.

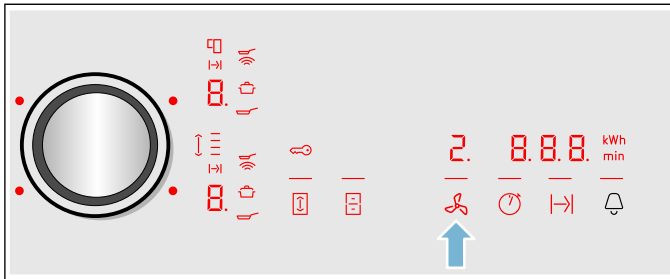

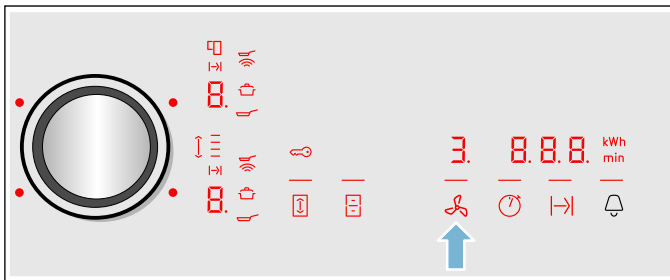

## Selecting the fan setting

1. Touch the  symbol.  
The ventilation system starts at fan setting **2**. The fan setting that is selected is shown on the display panel.
2. Use the rotary knob to select the required fan setting.  
The fan setting that is selected is shown on the display panel.



## Switching off the ventilation system

If you want to switch off the appliance, touch the  symbol. If you only want to switch off the ventilation system, proceed as follows:

1. Touch the  symbol.
2. Use the rotary knob to select the required fan setting **0**.
3. Touch the  symbol to switch to the setting area for the hob.

**Note:** The run-on will start once the appliance has been switched off (depending on the basic settings selected).

## Intensive setting

Activate intensive mode to eliminate strong smells and odours. In this mode, the extractor hood operates at its maximum fan setting for a short time. After a short time, it automatically switches back to a low setting.

### Switching on

1. Touch the  symbol.
2. Turn the rotary knob until **P** appears.

**P** will be shown on the display panel. The line below the **P** symbol will flash. Intensive mode is now activated.

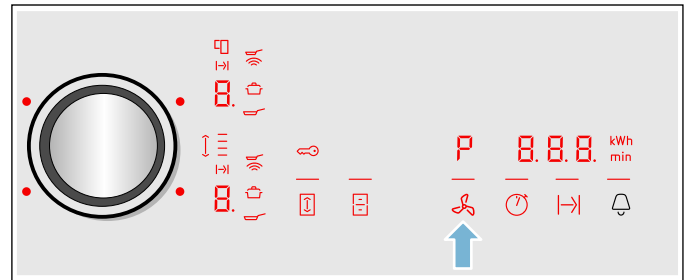

**Note:** After eight minutes, the appliance automatically switches back to fan setting **9**.

### Switching off

1. Touch the  symbol.
2. Use the rotary knob to select the required fan setting **0**.  
This sets the fan setting for the extractor hood to **0**.

## Automatic start





Depending on the basic settings selected, the following options will be available once you have selected the fan setting for a cooking zone:

- The ventilation system will not start.
- The ventilation system will start at the fan setting selected by the sensor.
- The ventilation will start at a specified fan setting.

Select the option you want to use in the basic settings. The basic settings also offer the option to adjust the sensitivity of the sensor.



## Automatic mode with sensor control

### Switching on

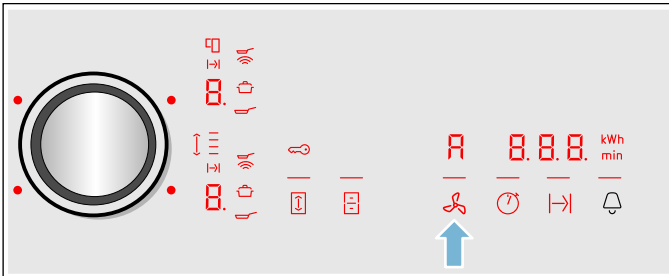
1. Touch the  symbol.  
The ventilation system starts at fan setting 2.
2. Turn the rotary knob until  appears.
3. Touch the  symbol.  
The line below the  symbol flashes. The optimum fan setting is set automatically using a sensor.



### Switching off

1. Touch the  symbol.
2. Use the rotary knob to select another fan setting, or turn it until  appears.  
The fan setting that is selected is shown on the display panel. Automatic mode with sensor control is switched off.

## Run-on function

The run-on function leaves the ventilation system running for a few minutes after it has been switched off. This eliminates any remaining cooking smells. The ventilation system will switch off automatically afterwards.

In the basic settings, you can select the following options for the run-on:



- Deactivate the run-on
- Activate the automatic function with sensor-controlled run-on
- Activate the run-on for a fixed period at a fixed fan setting

## Cooking table

The table shows which heat setting is suitable for each type of food. The cooking time may vary depending on the type, weight, thickness and quality of the food.

	Heat setting	Cooking time (mins)
<b>Melting</b>		
Chocolate coating	1 - 1.	-
Butter, honey, gelatine	1 - 2	-
* Without lid		
** Turn several times		
*** Preheat to heat setting 8 - 8.		

**Note:** If at least one cooking zone has been switched on for at least one minute, the run-on is automatically switched on.

If the automatic function with sensor-controlled run-on is activated, the , the line above the  symbol and the  symbol light up during the run-on.

### Switching off

Touch the  symbol.

This will deactivate the run-on function immediately.

If one of the following conditions is present, the run-on function is switched off:

- The run-on time has expired.
- The appliance is switched on again.
- When the automatic function is activated with a sensor-controlled run-on, the sensor determines a corresponding room-air quality level.

## Chef's recommendations

### Recommendations

- When heating up puree, cream soups and thick sauces, stir occasionally.
- Set heat setting 8 to 9 for preheating.
- When cooking with the lid on, turn the heat setting down as soon as steam escapes between the lid and the cookware. Steam does not need to escape for a good cooking result.
- After cooking, keep the lid on the cookware until you serve the food.
- To cook with the pressure cooker, observe the manufacturer's instructions.
- Do not cook food for too long, otherwise the nutrients will be lost. The kitchen clock can be used to set the optimum cooking time.
- For a more healthy cooking result, smoking oil should be avoided.
- To brown food, fry small portions in succession.
- Cookware may reach high temperatures while the food is cooking. We recommend that you use oven gloves.
- You can find recommendations for energy-efficient cooking in section → "Environmental protection"

	Heat setting	Cooking time (mins)
<b>Heating and keeping warm</b>		
Stew, e.g. lentil stew	1 - 2	-
Milk*	1 - 2.	-
Heating sausages in water*	3 - 4	-
<b>Defrosting and heating</b>		
Spinach, frozen	3 - 4	15 - 25
Goulash, frozen	3 - 4	35 - 55
<b>Poaching, simmering</b>		
Potato dumplings*	4 - 5.	20 - 30
Fish*	4 - 5	10 - 15
White sauces, e.g. Béchamel sauce	1 - 2	3 - 6
Whisked sauces, e.g. sauce béarnaise, hollandaise	3 - 4	8 - 12
<b>Boiling, steaming, braising</b>		
Rice (with double the volume of water)	2 - 3.	15 - 30
Rice pudding***	2 - 3	30 - 40
Unpeeled boiled potatoes	4 - 5.	25 - 35
Boiled potatoes	4 - 5.	15 - 30
Pasta, noodles*	6 - 7	6 - 10
Stew	3 - 4.	120 - 180
Soups	3 - 4.	15 - 60
Vegetables	2 - 3.	10 - 20
Vegetables, frozen	3 - 4.	7 - 20
Cooking in a pressure cooker	4 - 5.	-
<b>Braising</b>		
Roulades	4 - 5	50 - 65
Pot roast	4 - 5	60 - 100
Goulash***	3 - 4	50 - 60
* Without lid		
** Turn several times		
*** Preheat to heat setting 8 - 8.		

	Heat setting	Cooking time (mins)
<b>Roasting/frying with little oil*</b>		
Escalope, plain or breaded	6-7	6-10
Escalope, frozen	6-7	8-12
Chop, plain or breaded**	6-7	8-12
Steak (3 cm thick)	7-8	8-12
Poultry breast (2 cm thick)**	5-6	10-20
Poultry breast, frozen**	5-6	10-30
Rissoles (3 cm thick)**	4.-5.	20-30
Hamburgers (2 cm thick)**	6-7	10-20
Fish and fish fillet, plain	5-6	8-20
Fish and fish fillet, breaded	6-7	8-20
Fish, breaded and frozen, e.g. fish fingers	6-7	8-15
Scampi, prawns	7-8	4-10
Sautéing fresh vegetables and mushrooms	7-8	10-20
Stir-fry, vegetables, meat cut in Asian-style strips	7-8	15-20
Frozen dishes, e.g. roasted dishes	6-7	6-10
Pancakes (baked in succession)	6.-7.	-
Omelette (cooked in succession)	3.-4.	3-6
Fried eggs	5-6	3-6
<b>Deep-fat frying* (150-200 g per portion in 1-2 l oil, deep-fat fried in portions)</b>		
Frozen products, e.g. chips, chicken nuggets	8-9	-
Croquettes, frozen	7-8	-
Meat, e.g. chicken portions	6-7	-
Fish, breaded or in beer batter	6-7	-
Vegetables, mushrooms, breaded or battered, tempura	6-7	-
Small baked items, e.g. doughnuts, fruit in batter	4-5	-
* Without lid		
** Turn several times		
*** Preheat to heat setting 8 - 8.		

## Flex Zone

You can use each flex zone as a single hotplate or as two independent hotplates, as required.

It consists of four inductors that work independently of each other. If using the flexible cooking zone, only the area that is covered by cookware is activated.

### Advice on using cookware

To ensure that the cookware is detected and heat is distributed evenly, correctly centre the cookware:

**As a single hotplate**

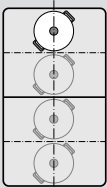

Diameter smaller than or equal to 13 cm  
Place the cookware on one of the four positions that can be seen in the illustration.

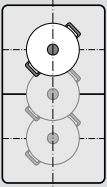

Diameter greater than 13 cm  
Place the cookware on one of the three positions that can be seen in the illustration.

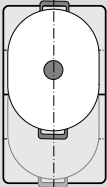

If the cookware takes up more than one hotplate, place it starting on the upper or lower edge of the flexible cooking zone.

**As two independent hotplates**

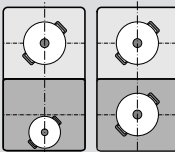

The front and rear hotplates each have two inductors and can be used independently of each other. Select the required heat setting for each of the hotplates. Use only one item of cookware on each hotplate.

### As two independent hotplates

The flexible cooking zone is used like two independent hotplates.



#### Activating

See section → "Operating the appliance"

### As a single hotplate

Using the entire cooking zone by connecting both hotplates.

#### Linking the two hotplates

1. Set down the cookware. Select one of the two hotplates in the flexible cooking zone and set the heat setting.
2. Touch the  symbol. The  indicator lights up. The flexible cooking zone is activated.

**Note:** The heat setting appears in the two displays for the flexible cooking zone.

#### Changing the heat setting

Select one of the two hotplates assigned to the flexible cooking zone and set the heat setting using the twist knob.

#### Adding new cookware

Set the new item of cookware down, select one of the two hotplates in the flexible cooking zone and then touch the  symbol twice. The new cookware is detected and the previously selected heat setting remains the same.

**Note:** If the cookware is moved to the hotplate being used or lifted up, the hotplate begins an automatic search and the heat setting selected previously is retained.

#### Disconnecting the two hotplates

Select one of the two hotplates assigned to the flexible cooking zone and touch the  symbol.

This deactivates the flexible cooking zone. The two hotplates will now function independently.

**Note:** If the hob is switched off, and then switched back on again later, the flexible cooking zone is reset to function as two independent hotplates.



## Move function

This function activates the entire flexible cooking zone, which is divided into three cooking areas and which has preset heat settings.

Only use one item of cookware. The size of the cooking area depends on the cookware used and whether it is positioned correctly.

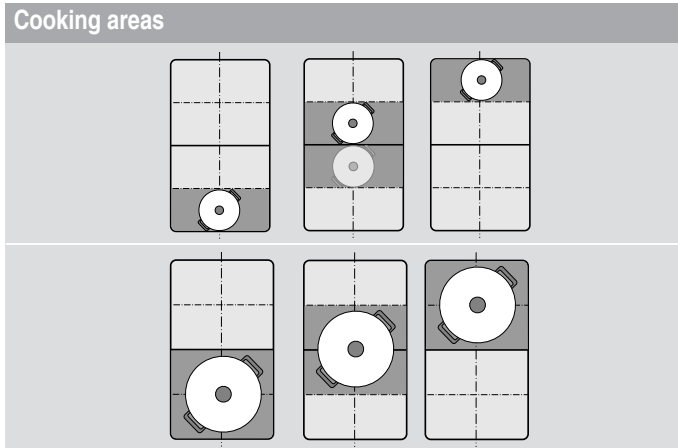

This means that an item of cookware can be moved during the cooking process to another cooking area with another heat setting:

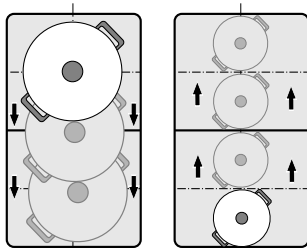

Preset heat settings:

Front area = heat setting 9

Middle area = heat setting 5



Rear area = heat setting 1.

The preset heat settings can be changed independently of one another. You can find out how to change these in the section on → "Basic settings"

### Notes

- If more than one item of cookware is detected on the flexible cooking zone, the function is deactivated.
- If the cookware is moved within the flexible cooking zone or lifted up, the hob automatically starts searching and the heat setting of the area in which the vessel was detected is set.
- You can find information on the size and positioning of the cookware in the section on → "Flex Zone"

### Activation

1. Select one of the two hotplates in the flexible cooking zone.
2. Touch the  symbol. The indicator beside the  symbol lights up. The flexible cooking zone is activated as a single hotplate. The heat setting in the area in which the cookware is located lights up in the display for the front hotplate. The function has now been activated.



### Changing the heat setting

The heat settings for the individual cooking areas can be changed during the cooking process. Set the cookware down on the cooking area and change the heat setting using the twist knob.

### Notes

- Only the heat setting in the area in which the cookware is located is changed.
- If the function is deactivated, the heat settings for the three cooking areas are reset to the preset values.

### Deactivating

Touch the  symbol. The indicator beside the  symbol goes out.

The function was deactivated.

**Note:** If one of the cooking areas is set to , the function deactivates after a few seconds.

## Time-setting options

Your hob has three timer functions:

- Programming the cooking time
- Kitchen timer
- Stopwatch function

### Programming the cooking time

The hotplate automatically switches off after the time that is set has elapsed.

#### Setting procedure:

1. Select the hotplate and the required heat setting.
2. Touch the I→I symbol. The I→I display for the hotplate lights up. 00 lights up on the timer display.



3. Use the twist knob to select the required cooking time.

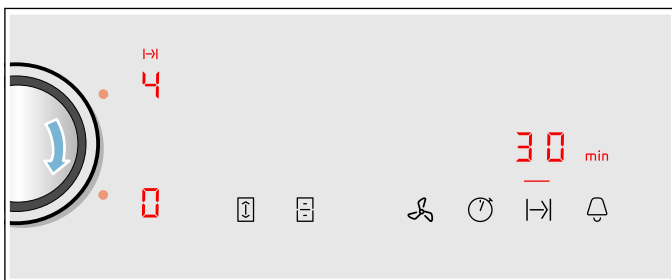

The cooking time begins to elapse.

#### Notes

- The same cooking time can be set automatically for all hotplates. The set time for each of the hotplates counts down independently. You can find information on automatically programming the cooking time in section → "Basic settings"
- If the flexible cooking zone is selected as the only hotplate, the set time for the entire cooking zone is the same.
- If the Move function is selected for the combined hotplate, the set time for the three hotplates is the same.

### Frying sensor

If a cooking time has been programmed for a hotplate and the frying sensor has been activated, the cooking time will not begin to count down until the selected temperature setting has been reached.

### Changing or deleting the time

Select the hotplate and then touch the I→I symbol.

Change the cooking time using the twist knob or on the control panel or set 00 to delete the programmed cooking time.

### When the time has elapsed

The hotplate switches off. An audible signal sounds, 00 appears in the hotplate display and 00 appears in the timer display for one minute. The hotplate indicator I→I flashes. Touch any symbol; the indicators go out and the audible signal ceases.

#### Notes



- If a cooking time was programmed for several hotplates, the cooking time which ends first appears in the timer display. The I→I display for the hotplate lights up.
- Select the relevant hotplate to call up the remaining cooking time for a hotplate. The cooking time is displayed for 10 seconds.
- You can set a cooking time of up to 99 minutes.

### The kitchen timer

You can use the kitchen timer to set a time of up to 99 minutes.

This functions independently from the hotplates and from other settings. This function does not automatically switch off a hotplate.

#### How to activate the function

1. Touch the  symbol: 00 and the — indicator appear in the timer display.
2. Use the twist knob to select the required time.
3. Touch the  symbol again to confirm the selected time.

The time begins to elapse.

### Changing or deleting the time

Touch the  symbol and use the twist knob to change the time or set it to 00.

### When the time has elapsed



An audible signal sounds for one minute and the 00 symbol flashes in the timer display. Touch the  symbol again: The displays go out and the audible signal ceases.

## Stopwatch function

The stopwatch function displays the time that has elapsed since activation.

This functions independently from the hotplates and from other settings. This function does not automatically switch off a hotplate.

### Activating

Touch the  symbol. The  symbol and the  indicator light up in the timer display.

The time begins to elapse.

### Deactivating



Touch the  symbol.  appear in the timer display and then go out.

The function is deactivated.

**Note:** This function must be selected in order to deactivate the stopwatch.

## PowerBoost function

The PowerBoost function enables you to heat up large quantities of water faster than when using heat setting .

This function can always be activated for a hotplate, provided the other hotplate in the same group is not in use (see illustration). Otherwise,  and  will flash in the display for the selected hotplate; the  heat setting will then be set automatically without activating the function.

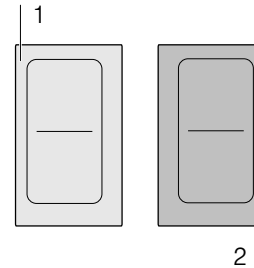





**Note:** The PowerBoost function can also be activated in the flexible area if the cooking zone is being used as a single hotplate.

### Activating

1. Select a hotplate.
2. Touch the  symbol. The  and  indicators light up.

The function is activated.

### Deactivating

1. Select a hotplate.
2. Touch the  symbol. The  and  indicators go out. The heat setting  lights up in the hotplate's display.

The function is deactivated.

**Note:** In certain circumstances, the PowerBoost function can switch itself off automatically in order to protect the electronic elements inside the hob.



## ShortBoost function

The ShortBoost function enables you to heat cookware faster than when using heat setting 9.

After deactivating the function, select the appropriate heat setting for your food.

This function can always be activated for a hotplate, provided the other hotplate in the same group is not in use (see illustration). Otherwise, P and 9 will flash in the display for the selected hotplate; the 9 heat setting will then be set automatically without activating the function.

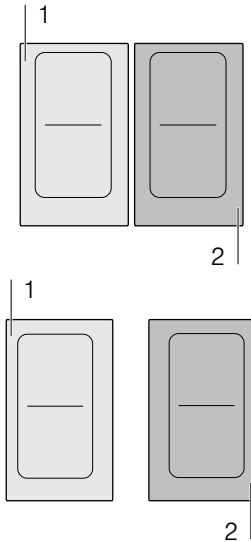

**Note:** With the flexible cooking zone, the ShortBoost function can be activated even if it is used as the only cooking zone.

### Recommendations for use

- Always use cookware that has not been pre-heated.
- Use pots and pans with a flat base. Do not use cookware with a thin base.
- Never leave empty cookware, oil, butter or lard to heat up unattended.
- Do not place a lid on the cookware.
- Place the cookware on the centre of the hotplate. Ensure that the diameter of the base of the cookware corresponds to the size of the hotplate.
- You can find information on the type, size and positioning of the cookware in section → "Induction cooking"

### Activating

1. Select a hotplate.
2. Touch the P symbol twice. The P and  indicators light up.

The function is activated.

### Deactivating

1. Select a hotplate.
2. Touch the P symbol. The P and  displays go out. The heat setting 9 lights up in the display for the hotplate.

The function is deactivated.



**Note:** In certain circumstances, the ShortBoost function can switch itself off automatically in order to protect the electronic elements inside the hob.





## Keep warm function

This function is suitable for melting chocolate or butter and for keeping food warm.

### Activation

1. Select the required hotplate.
2. Touch the  within the next 10 seconds.  
 lights up on the display.  
The function is activated.

### Deactivation

1. Select the hotplate.
2. Touch the  symbol.  
The  indicator goes out. The hotplate switches itself off and the residual heat indicator lights up.  
The function is deactivated.



## Frying Sensor

This function can be used to fry food while maintaining the suitable frying pan temperature.

The cooking zones that have this function are identified by the roasting function symbol.

### Advantages when frying

- The hotplate only heats up if this is required to maintain the temperature. This saves energy and prevents the oil or fat from overheating.
- The roasting function reports when the empty frying pan has reached the optimum temperature for adding oil and then for adding the food.

### Notes

- Do not place a lid on the pan. Otherwise, the function does not activate correctly. You can use a splash guard to prevent splashes of grease.
- Use suitable oil or fat for frying. If butter, margarine, extra virgin olive oil or lard is used, set heat setting 1 or 2.
- Never leave a frying pan, with or without food, unattended when it is being heated.
- If the hotplate is a higher temperature than the cookware or vice versa, the frying sensor will not be activated correctly.

### For frying with the frying sensor

Frying pans that are perfect for using with the frying sensor can be purchased from specialist retailers or through our technical after-sales service. Quote the relevant reference number.

- Z9451X0 15 cm frying pan.
- Z9452X0 19 cm frying pan.
- Z9453X0 21 cm frying pan.

These frying pans have a non-stick coating so that you require only a small amount of oil to fry food.

### Notes

- The frying sensor has been configured specifically for this type of frying pan.
- Ensure that the diameter of the base of the frying pan corresponds to the size of the hotplate. Put the frying pan in the centre of the hotplate.
- Using a frying pan of a different size or one that is poorly positioned on the flexible cooking zones may result in the frying sensor not being activated. See the section on → "Flex Zone".
- Other frying pans may overheat. They may reach a temperature above or below the selected temperature setting. Try the lowest temperature setting to begin with and change it if necessary.

## Temperature settings

Temperature setting	Suitable for
1	Very low
2	Low
3	Medium - low
4	Medium - high
5	High

### Table

The table shows which heat setting is suitable for each type of food. The roasting time may vary depending on the type, weight, size and quality of the food.

The set heat setting varies depending on the frying pan that is used.



Preheat the empty pan; add oil and food after the acoustic signal has sounded.

	Temperature setting	Total frying time after the signal sounds (mins.)
<b>Meat</b>		
Escalope, plain or breaded	4	6 - 10
Fillet	4	6 - 10
Chops*	3	10 - 15
Cordon bleu, Wiener Schnitzel*	4	10 - 15
Steak, rare (3 cm thick)	5	6 - 8
Steak, medium or well-done (3 cm thick)	4	8 - 12
Poultry breast (2 cm thick)*	3	10 - 20
Sausages, pre-boiled or raw*	3	8 - 20
Hamburger, meatballs, rissoles*	3	6 - 30
Meat loaf	2	6 - 9
Ragout, gyros	4	7 - 12
Ground meat	4	6 - 10
Bacon	2	5 - 8
<b>Fish</b>		
Fish, fried, whole, e.g. trout	3	10 - 20
Fish fillet, plain or breaded	3 - 4	10 - 20
Prawns, scampi	4	4 - 8
<b>Egg dishes</b>		
Pancakes**	5	-
Omelette**	2	3 - 6
Fried eggs	2 - 4	2 - 6
Scrambled eggs	2	4 - 9
Raisin pancake	3	10 - 15
French toast**	3	4 - 8
* Turn several times.		
** Total cooking time per portion. Fry in succession.		

	Temperature setting	Total frying time after the signal sounds (mins.)
<b>Potatoes</b>		
Fried potatoes (boiled in their skin)	5	6 - 12
French fries (made from raw potatoes)	4	15 - 25
Potato fritter**	5	2,5 - 3,5
Swiss rösti	1	50 - 55
Glazed potatoes	3	15 - 20
<b>Vegetables</b>		
Garlic, onions	1 - 2	2 - 10
Courgettes, aubergines	3	4 - 12
Peppers, green asparagus	3	4 - 15
Vegetables sautéed in oil, e.g. courgettes, green peppers	1	10 - 20
Mushrooms	4	10 - 15
Glazed vegetables	3	6 - 10
<b>Frozen products</b>		
Escalope	4	15 - 20
Cordon bleu*	4	10 - 30
Poultry breast*	4	10 - 30
Chicken nuggets	4	10 - 15
Gyros, kebab	3	5 - 10
Fish fillet, plain or breaded	3	10 - 20
Fish fingers	4	8 - 12
French fries	5	4 - 6
Stir-fries meals, e.g. fried vegetables with chicken	3	6 - 10
Spring rolls	4	10 - 30
Camembert/cheese	3	10 - 15
<b>Sauces</b>		
Tomato sauce with vegetables	1	25 - 35
Béchamel sauce	1	10 - 20
Cheese sauce, e.g. Gorgonzola sauce	1	10 - 20
Reducing sauces, e.g. tomato sauce, Bolognese sauce	1	25 - 35
Sweet sauces, e.g. orange sauce	1	15 - 25
<b>Miscellaneous</b>		
Camembert/cheese	3	7 - 10
Dry ready meals that require water to be added, e.g. pasta	1	5 - 10
Croutons	3	6 - 10
Almonds/walnuts/pine nuts	4	3 - 15
* Turn several times.		
** Total cooking time per portion. Fry in succession.		

## Setting procedure

Select the appropriate temperature setting from the table. Place the empty frying pan on the hotplate.

1. Select the hotplate and touch the  symbol.  lights up in the hotplate display.

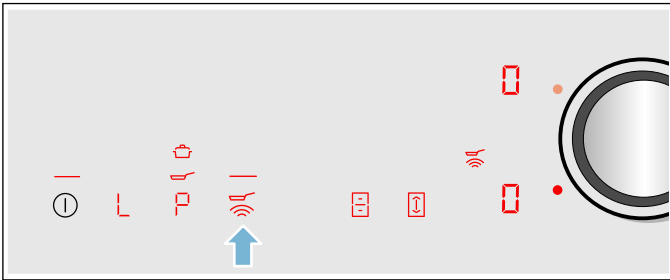

2. Within the next 5 seconds, select the required temperature setting using the twist knob.

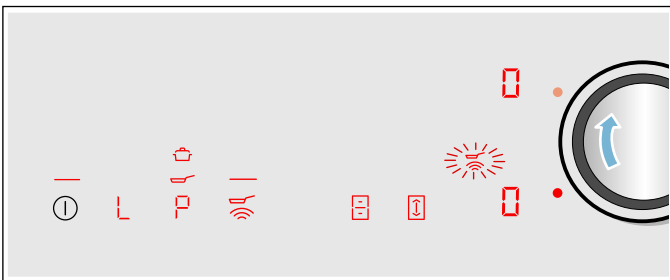

The function has now been activated.

The  temperature symbol flashes until the frying temperature is reached. A signal sounds and the temperature symbol lights up.

3. Once the frying temperature has been reached, add the fat and then the food to the pan.

**Note:** Turn the food so that it does not burn.

### Switching off the frying sensor



Select the hotplate and touch the  symbol. The function is deactivated.

## Childproof lock

You can use the childproof lock to prevent children from switching on the hob.

### Activating and deactivating the childproof lock

The hob must be switched off.

To activate: Touch the  symbol for approx. 4 seconds. The  indicator lights up for 10 seconds. The hob is locked.

To deactivate: Touch the  symbol for approx. 4 seconds. The lock is released.

### Childproof lock

With this function, the childproof lock automatically activates when a hob is switched off.

### Switching on and off

You can find out how to switch the automatic childproof lock on in the → *"Basic settings"* section



## Wipe protection

Wiping over the control panel while the hob is switched on may alter the settings. To avoid doing this, you can use the hob's "Lock control panel for cleaning" function.

To activate this function: Remove the twist knob. The  indicator will be lit. The control panel will remain locked for 35 seconds. You will now be able to clean the surface of the control panel without altering the settings.

To deactivate this function: The control panel will be unlocked once 35 seconds have elapsed. To end the function early, fit the twist knob back on and turn it until the  indicator goes out.

### Notes

- The timer displays the time that has elapsed since the lock was activated. An audible signal sounds 30 seconds after activation. This indicates that the function is about to finish.
- The cleaning lock does not lock the main switch. The hob can be switched off at any time.



## Automatic safety cut-out

If a hotplate operates for an extended period and no settings are changed, the automatic safety shut-off is activated.

The hotplate stops heating. **F**, **B** and the residual heat indicator **h** or **H** flash alternately in the hotplate display.

When you touch any symbol, the display switches off. The hotplate can now be set again.

The point at which the safety shut-off becomes active depends on which heat setting has been set (after 1 to 10 hours).

## Basic settings

The appliance has various basic settings. You can adapt these to suit your cooking habits.

Display	Function
<b>c 1</b>	<b>Automatic childproof lock</b> <b>0</b> Manual*. <b>1</b> Automatic. <b>2</b> Function deactivated.
<b>c 2</b>	<b>Audible signals</b> <b>0</b> Confirmation and fault signals are switched off. <b>1</b> Only the fault signal is switched on. <b>2</b> Only the confirmation signal is switched on. <b>3</b> All audible signals are switched on.*
<b>c 3</b>	<b>Display energy consumption</b> <b>0</b> Switched off.* <b>1</b> Switched on.
<b>c 5</b>	<b>Automatically programme the cooking time</b> <b>00</b> Switched off.* <b>0 1-99</b> Time until automatic switch-off.
<b>c 6</b>	<b>Duration of the timer end signal</b> <b>1</b> 10 seconds. <b>2</b> 30 seconds. <b>3</b> 1 minute.*
<b>c 7</b>	<b>Power management function. Limit the total power of the hob</b> <b>0</b> Switched off.* <b>1</b> 1000 W minimum power. <b>1.</b> 1500 W. <b>2</b> 2000 W. <b>...</b> <b>9 or 9.</b> Maximum power of the hob.
<b>c 9</b>	<b>Time for selecting the hotplate</b> <b>0</b> Unlimited: The hotplate that was set last remains selected. <b>1</b> Limited: The hotplate only remains selected for a few seconds.*
<b>c 11</b>	<b>Change the preset heat settings for the Move function</b> <b>_9</b> Preset heat setting for the front cooking zone. <b>-5</b> Preset heat setting for the central cooking zone. <b>7L</b> Preset heat setting for the rear cooking zone.
<b>c 12</b>	<b>Check cookware, result of the cooking process</b> <b>0</b> Not suitable <b>1</b> Not perfect <b>2</b> Suitable



\* Factory settings

Display	Function
<b>c 17</b>	<b>Set air recirculation mode or air extraction mode</b> 0 Air recirculation mode has been set.* 1 Air extraction mode has been set.
<b>c 18</b>	<b>Set automatic start</b> 0 Switched off. 1 Switched on: Automatic mode with sensor control* 2 Switched on: The ventilation starts at a fixed fan setting.
<b>c 19</b>	<b>Set the sensor sensitivity for the ventilation system</b> 1 Lowest sensor sensitivity setting. 2 Medium sensor sensitivity setting.* 3 Highest sensor sensitivity setting.
<b>c 20</b>	<b>Set the run-on</b> 0 Switched off. 1 Switched on: Automatic function with sensor-controlled run-on.* 2 Switched on: The ventilation system runs in air extraction mode for approx. six minutes and in circulating air mode for approx. 30 minutes at fan setting 1 and automatically switches off once this time has elapsed.
<b>c 0</b>	<b>Restore the factory settings</b> 0 Individual settings.* 1 Restore to factory settings.

\* Factory settings

### To access the basic settings:

The hob must be off.

1. Switch on the hob.
2. Within ten seconds, touch and hold the  symbol for approximately three seconds. The first four displays provide product information. Turn the twist knob to view the individual displays.
3. Within ten seconds, touch and hold the  symbol for approximately four seconds. The first four displays provide product information. Turn the twist knob to view the individual displays.

Product information	Display screen
After-sales service index (ASSI)	01
Production number	Fd
Production number 1	95.
Production number 2	05

4. Touch the  symbol again to access the basic settings. **c 1** and **0** light up as a presetting in the displays.

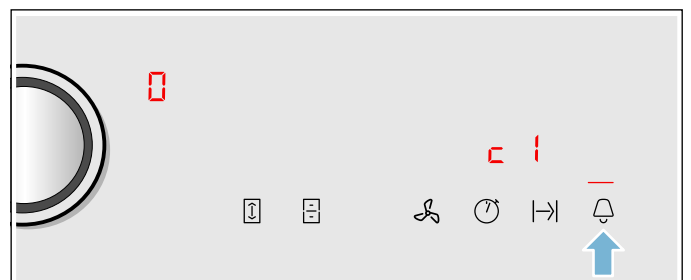

5. Touch the  symbol repeatedly until the required function is displayed.
6. Then use the twist knob to select the required setting.

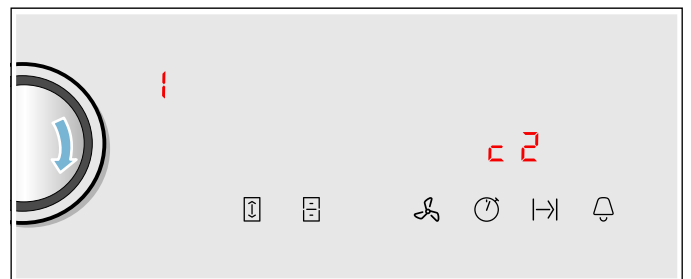

7. Touch the  symbol for at least four seconds.

The settings have been saved.

### Leaving the basic settings

Turn off the hob with the main switch.



## Energy consumption indicator

This function indicates the total amount of energy consumed by this hob the last time it was used for cooking.

Once switched off, the energy consumption in kWh is displayed for 10 seconds.

The picture shows an example with an energy consumption of **1.08 kWh**.



You can find out how to switch this function on in the section on → "Basic settings"

## Cookware check

This function can be used to check the speed and quality of the cooking process depending on the cookware.



The result is a reference value and depends on the properties of the cookware and the hotplate being used.

1. With the cookware still cold, fill it with approx. 200 ml of water and place it on the centre of the hotplate with the diameter that most closely matches that of the base of the cookware.
2. Go to the basic settings and select the **c 12** setting.
3. Turn the twist knob. **—** flashes on the hotplate displays.  
The function is activated.

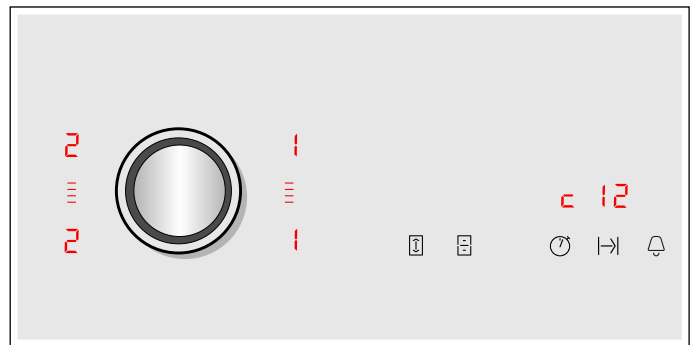
After 10 seconds, information on the quality and speed of the cooking process appears in the hotplate displays.



Check the result using the following table:

Result	
	The cookware is not suitable for the hotplate and will therefore not heat up.*
	The cookware is taking longer to heat up than expected and the cooking process is not going as well as it should.*
	The cookware is heating up correctly and the cooking process is going well.
* If there is a smaller hotplate available, test the cookware again on the smaller hotplate.	

To reactivate the function, turn the twist knob.

### Notes

- The flexible cooking zone only counts as a single hotplate; place no more than one item of cookware on it.
- If the diameter of the hotplate used is much smaller than the diameter of the cookware, only the middle of the cookware can be expected to heat up. This may result in the cooking results not being as good as expected or being less than satisfactory.
- You can find information on this function in the section on → "Basic settings".
- You can find information on the type, size and positioning of the cookware in the sections on → "Induction cooking" and → "Flex Zone".

# Cleaning

## Warning – Risk of burns!

The appliance becomes hot during operation. Allow the appliance to cool down before cleaning.

## Warning – Risk of electric shock!

Do not use any high-pressure cleaners or steam cleaners, which can result in an electric shock.

## Warning – Risk of electric shock!

Penetrating moisture may result in an electric shock. Clean the appliance using a damp cloth only. Before cleaning, pull out the mains plug or switch off the circuit breaker in the fuse box.

## Warning – Risk of injury!

Components inside the appliance may have sharp edges. Wear protective gloves.

**Note:** Only use a minimal amount of water when cleaning so that no water enters the appliance.

### Notes

- Before cleaning the appliance, remove any jewellery you are wearing on your arms and hands.
- Do not use any cleaning agents while the hob is still hot. This may mark the surface. Ensure that any residue left by cleaning agents is removed.

## Cleaning agents

Only use cleaning products that are suitable for this type of hob. Follow the manufacturer's instructions on the product packaging.

Follow all instructions and warnings included with the cleaning products.

Suitable maintenance and cleaning products can be purchased from the after-sales service or in our e-Shop.

### Caution!

#### Beware of causing surface damage

Do not use:

- Undiluted washing-up liquid
- Cleaning products designed for dishwashers
- Abrasive cleaning products
- Pressure washers or steam jet cleaners
- Oven cleaners
- Corrosive or aggressive cleaners, or those containing chlorine
- Cleaners containing a large percentage of alcohol
- Hard, scratchy sponges, brushes or scouring pads

### Caution!

#### Beware of causing surface damage

Always wash new sponge cloths thoroughly before use.

To ensure that the different surfaces are not damaged by using the wrong cleaning product, follow the instructions in the table.

Area	Cleaning products
Glass ceramic	<p>Glass cleaner for stains caused by limescale and residual water: Clean the hob as soon as it has cooled down. You can use a cleaning product that is suitable for glass-ceramic hobs or glass cleaner (article no. 00311499).</p> <p>Glass scraper (article no. 00087670) for stains caused by sugar, rice starch or plastic: Clean immediately. Caution: Risk of burns. Then clean with a damp dish cloth and dry with a cloth or towel.</p> <p><b>Note:</b> Do not use cleaning products designed for dishwashers.</p>
Stainless steel	<p>Hot soapy water: Clean with a dish cloth and then dry with a soft cloth.</p> <p>Only use a minimal amount of water when cleaning so that no water enters the appliance.</p> <p>Leave dried-on remains to soak in a small amount of soapy water; do not scour.</p> <p>Clean stainless steel surfaces in the direction of the grain only.</p> <p>Special stainless steel cleaning products (article no. 00311499) are available from our after-sales service, through our online shop or from specialist retailers. Apply a very thin layer of the cleaning product with a soft cloth.</p> <p><b>Note:</b> Do not use a glass scraper to clean the hob surround.</p>
Plastic	<p>Hot soapy water: Clean with a soft cloth or in the dishwasher.</p>
Controls	<p>Hot soapy water or an appropriate glass cleaner (article no. 00311499): Clean using a damp dish cloth and then dry with a soft cloth.</p>
Cast iron (filter cover)	<p>Hot soapy water or an appropriate glass cleaner (article no. 00311499): Clean using a damp dish cloth and then dry with a soft cloth.</p> <p><b>Note:</b> Do not clean in the dishwasher.</p>

## Components to clean

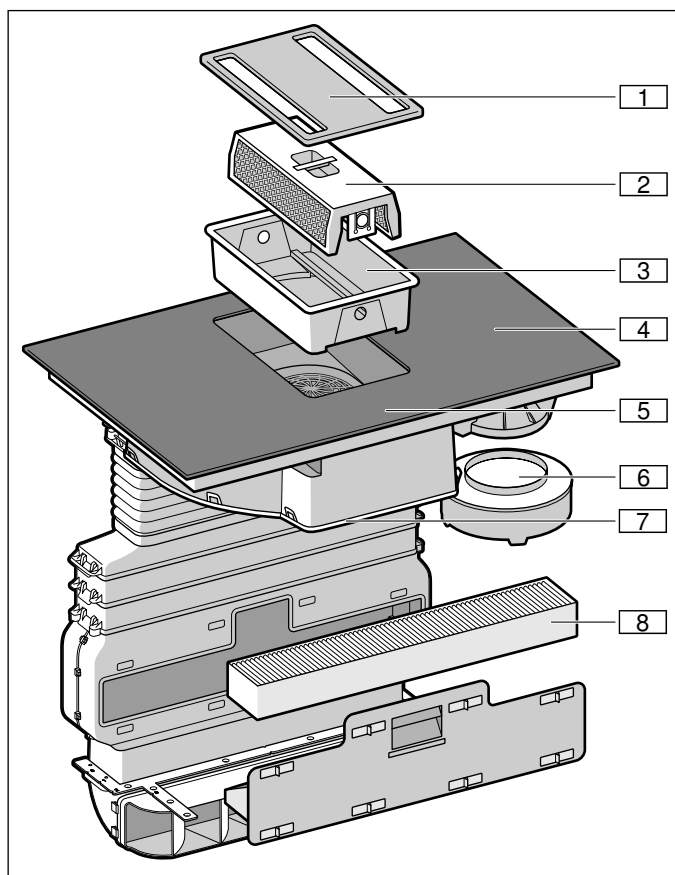

No.	Name
1	Filter cover
2	Metal grease filter
3	Container
4	Hob
5	Control panel
6	Overflow container
7	Housing cover
8	Activated charcoal filter (only in air recirculation mode)

## Hob surround (only on appliances with hob surrounds)

To prevent damage to the hob surround, observe the following instructions:

- Only use warm soapy water
- Wash new dish cloths thoroughly before use.
- Do not use harsh or abrasive cleaning agents.
- Do not use a glass scraper or sharp objects.

## Hob

Clean the hob each time you use it. This will prevent food remnants from becoming burned on. Do not clean the hob until the residual heat indicator has gone out. Remove boiled-over liquids immediately and do not allow any food remains to dry on.

Clean the hob with a damp dish cloth and dry it with a cloth or towel to prevent limescale build-up.

Stubborn dirt is best removed with a glass scraper or glass ceramic cleaner (available from retailers). Follow the manufacturer's instructions.

You can obtain a suitable glass scraper (article no. 00087670) from our after-sales service or through our online shop.

Using a special sponge for cleaning glass-ceramic hobs achieves great cleaning results.

## Ventilation system

The filter must be regularly cleaned or replaced in order to guarantee efficient filtration of odours and grease.

### Metal grease filter

The metal grease filters should be cleaned every 30 operating hours or at least once a month.

### **⚠ Warning – Risk of fire!**

Grease deposits in the grease filter may catch fire.

**Clean the grease filter at least once a month.**

Never operate the appliance without the grease filter.

### Activated charcoal filters

The activated charcoal filter should be replaced regularly. The saturation indicator on your appliance will tell you how frequently this needs to be done.

### Saturation display

If the metal grease filter or activated charcoal filter becomes saturated, a signal will sound once the appliance has been switched off.

The following symbols will light up in the display panel:

- **Metal grease filter:** *F 10* lights up
- **Activated charcoal filter:** *F 11* lights up
- **Metal grease filter and activated charcoal filter:** *F 10* and *F 11* light up alternately

Do not wait any longer to clean the metal grease filter or replace the activated charcoal filter.

### Changing the activated charcoal filter (only in circulating-air mode)

Activated charcoal filters trap the odour-causing compounds in cooking smells. They are only used for circulating-air mode.

#### Notes

- The activated charcoal filter is not included with the appliance. The activated charcoal filter (article number Z8500X0) is available from specialist retailers, from our after-sales service or from our online shop.
- The activated charcoal filter cannot be cleaned or reactivated.
- Only use genuine replacement filters. This ensures that the appliance performs optimally.

1. Unlock all of the closing elements on the drawer in the flat duct of the fitted unit.

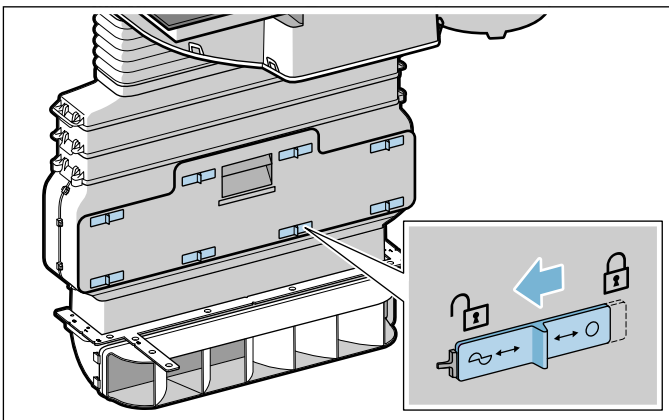

2. Open the drawer in the flat duct and remove the activated charcoal filter.

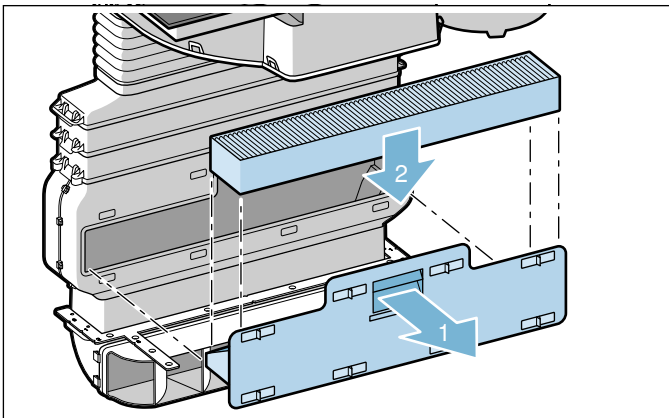

3. Insert the new activated charcoal filter.
4. Close the drawer in the flat duct and lock all of the closing elements.

**Note:** Make sure that all of the closing elements have been locked correctly. Otherwise noises may be generated and the power of the ventilation system may be reduced.

### Removing metal grease filter

The metal grease filters filter the grease out of kitchen steam. To keep them in good working order, the filters should be cleaned at least once a month.

1. Take the filter cover off.

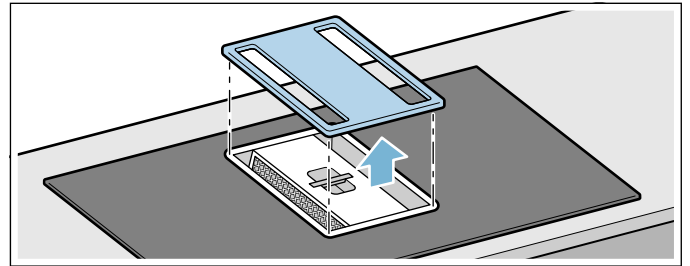

**Note:** Make sure that the filter cover does not fall and damage the hob.

2. Take the metal grease filter and the container out.

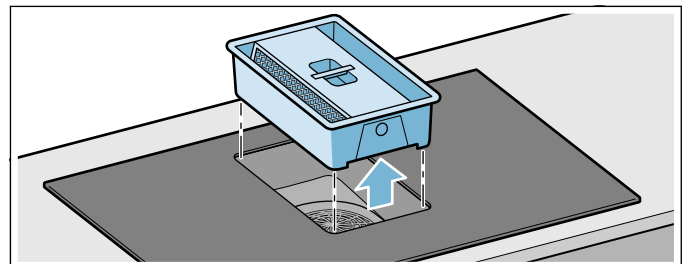

**Note:** Fat may accumulate in the bottom of the container. Hold the metal grease filter level to prevent grease from dripping out.

3. Press down on the catches on either side of the container to separate the metal grease filter from the container.

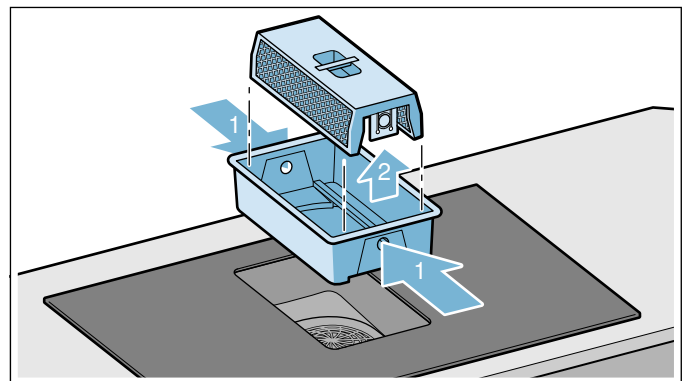

4. Empty the container if necessary.
5. Clean the metal grease filter and filter cover.
6. After removing the metal grease filter, clean the inside of the appliance.

## Cleaning the metal mesh grease filters

### Notes

- Do not use aggressive, acidic or alkaline cleaning products.
- The metal grease filter can be cleaned in the dishwasher or by hand.

### By hand:

**Note:** You can use a special degreaser to remove stubborn dirt (article no. 00311297). This can be ordered through our online shop.

- Soak the metal grease filter in hot soapy water.
- Clean the metal grease filter with a brush and then rinse it thoroughly.
- Leave the metal grease filter to drain.

### In the dishwasher:

- Do not clean the metal grease filter together with tableware if heavily soiled.
- Place the metal grease filter in the dishwasher, leaving plenty of space around it. Do not trap the metal grease filter.

## Fitting and cleaning other appliance components

Also clean the inside of the hob extractor system regularly. You can use a special degreaser to remove stubborn dirt (article no. 00311297).

1. Take the filter cover off and clean it with a damp cloth or in the dishwasher.

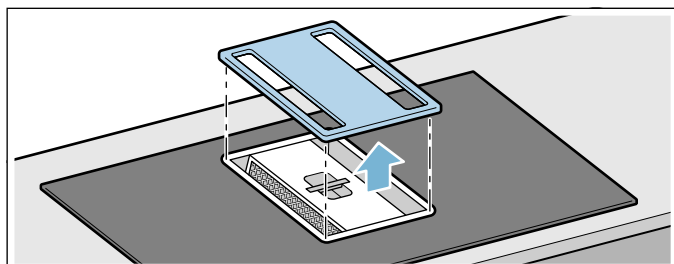

2. Take the metal grease filter and the container out.

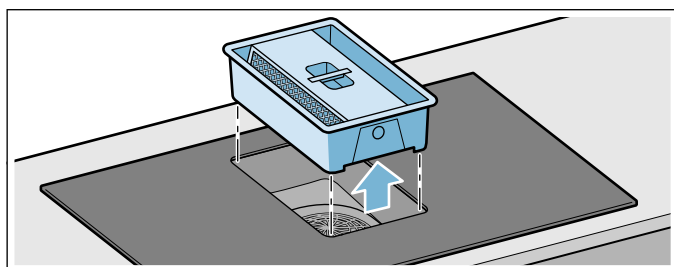

3. Press down on the catches on either side of the container to separate the metal grease filter from the container.

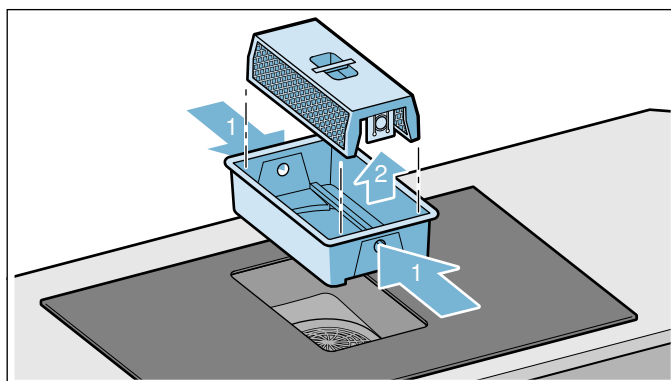

4. Empty the container if necessary.
5. Clean the metal grease filter and the container in the dishwasher.
6. If necessary, take off the housing cover underneath the appliance and clean it.

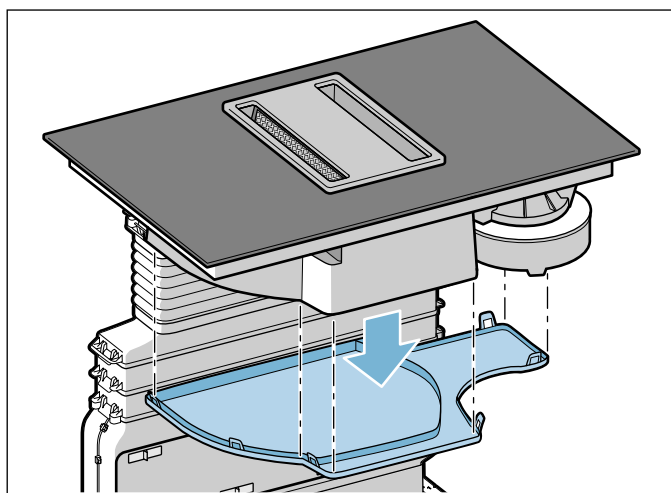

7. Clean the parts and dry them before putting them back together.

## Inserting the metal grease filters



1. Insert the container.
2. Insert the metal grease filter.
 

**Note:** Ensure that the metal grease filter has been inserted correctly. Otherwise, the ventilation system does not work.
3. Put the filter cover on.

## Resetting the saturation displays

Once you have cleaned or replaced the relevant filters, reset the saturation indicator so that the **F 10** and **F 11** indicators go out.

After switching off the appliance, **F 10** or **F 11** lights up.

1. Touch the  symbol.  
An audible signal sounds. The metal grease filter saturation indicator has now been reset.
2. If **F 11** lights up, touch the  symbol again.  
An audible signal sounds. The saturation indicator for the activated charcoal filter is reset.

## Cleaning the overflow container

### Notes

- Make sure that the supply to the overflow container is not blocked. Remove any objects that have entered the appliance once it has cooled down. To do this, take the filter cover off and take the metal grease filter and the container out.
- Any liquid entering the appliance from above will be collected in the overflow container. Unscrew the overflow container and empty it. Take the housing cover off if necessary.

1. Unscrew the overflow container with both hands.

### Notes

- Hold the overflow container level to prevent liquid from leaking out.
- Take the housing cover off if necessary.

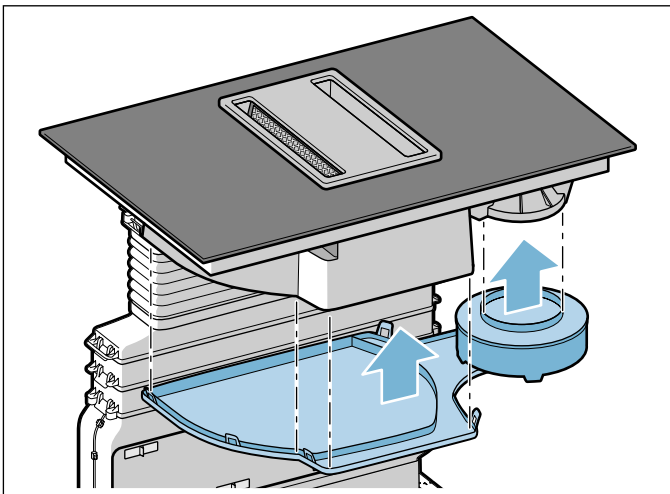

2. Empty the overflow container and rinse it out.
3. Clean the overflow container before screwing it back into place.
4. Refit the housing cover.

## Twist knob

The twist knob is best cleaned using lukewarm soapy water. Do not use harsh or abrasive cleaning agents. Do not clean the twist knob in the dishwasher or using rinsing water. This may damage it.

## Frequently Asked Questions (FAQ)

### Using the appliance

#### Why can't I switch on the hob and why is the childproof lock symbol lit?

The childproof lock is activated.  
You can find information on this function in the section on → "*Childproof lock*"

#### Why are the displays flashing and why can I hear an audible signal?

Remove any liquid or food remains from the control panel. Remove any objects from the control panel.  
You can find instructions on how to deactivate the audible signal in the section on → "*Basic settings*"

### Noises

#### Why I can hear noises while I'm cooking?

Noises may be generated while using the hob depending on the base material of the cookware. These noises are a normal part of induction technology. They do not indicate a defect.

#### Possible noises:

##### **A low humming noise like the one a transformer makes:**

Occurs when cooking at a high heat setting. The noise disappears or becomes quieter when the heat setting is reduced.

##### **Low whistling noise:**

Occurs when the cookware is empty. This noise disappears when water or food is added to the cookware.

##### **Crackling:**

Occurs when using cookware made from different layers of material or when using cookware of different sizes and different materials at the same time. The loudness of the noise can vary depending on the quantity of food being cooked or the cooking method.

##### **High-pitched whistling noises:**

Can occur when two hotplates are used at the highest heat setting at the same time. The whistling noises disappear or become quieter when the heat setting is reduced.

##### **Fan noise:**

The hob is equipped with a fan that switches on automatically at high temperatures. The fan may continue to run even after you have switched off the hob if the temperature detected is still too high.

### Cookware

#### Which types of cookware can be used with an induction hob?

You can find information on which types of cookware can be used with an induction hob in the section on → "*Induction cooking*".

#### Why is the hotplate not heating up and why is the heat setting flashing?

The hotplate on which the cookware is standing is not switched on.  
Check that you have switched on the correct hotplate.

The cookware is too small for the hotplate that is switched on or it is not suitable for induction cooking.

Check that the cookware is suitable for induction cooking and that it is placed on the hotplate that best corresponds to its size. You can find information on the type, size and positioning of cookware in the sections on → "*Induction cooking*", → "*Flex Zone*" and → "*Move function*".

#### Why is it taking so long for the cookware to heat up or why is it not heating up sufficiently despite being on a high heat setting?

The cookware is too small for the hotplate that is switched on or it is not suitable for induction cooking.

Check that the cookware is suitable for induction cooking and that it is placed on the hotplate that best corresponds to its size. You can find information on the type, size and positioning of cookware in the sections on → "*Induction cooking*", → "*Flex Zone*" and → "*Move function*".

## Cleaning

### How do I clean the hob?

Using a special glass-ceramic cleaning agent produces the best results. We advise against using harsh or abrasive cleaning agents, dish-water detergent (concentrated) or scouring pads.

You can find more information on cleaning and caring for your hob in the section on → "*Cleaning*"



## Trouble shooting

Usually, faults are small matters that are easy to eliminate. Please read the information in the table before calling the after-sales service.

Display	Possible cause	Troubleshooting
None	The power supply has been disconnected.  The appliance has not been connected as shown in the circuit diagram.  Electronics fault.	Use other electrical appliances to check whether a short circuit has occurred in the power supply.  Ensure that the appliance has been connected in accordance with the circuit diagram.  If the fault cannot be rectified, inform the technical after-sales service.
The symbol lighting does not work.	The control unit is faulty	Call the after-sales service.
The indicators are flashing	The control panel is wet or an object is covering it.	Dry the control panel or remove the object.
The <b>—</b> indicator is flashing in the hotplate displays	A fault has occurred in the electronics.	To acknowledge the fault, briefly cover the control panel with your hand.
The ventilation system does not work.	The metal grease filter has not been inserted correctly.  The sensor for the filter detection does not work.	Correctly insert the metal grease filter.  Call the after-sales service.
<b>F2</b>	The electronics have overheated and switched off the affected hotplate.	Wait until the electronics have cooled down sufficiently. Then touch any symbol on the hob.
<b>F4</b>	The electronics have overheated and all the hotplates have been switched off.	
<b>F5</b> + heat setting and signal tone	There is a hot pan near the control panel. There is a risk that the electronics will overheat.	Remove the pan. The fault indicator goes out shortly afterwards. You can resume cooking.
<b>F5</b> and signal tone	There is a hot pan near the control panel. To protect the electronics, the hotplate has been switched off.	Remove the pan. Wait a few seconds. Touch any control. When the fault code in the display goes out, you can resume cooking.
<b>F 1/F6</b>	The hotplate has overheated and has been switched off to protect your work surface.	Wait until the electronics have cooled down sufficiently and switch the hotplate on again.
<b>F8</b>	The hotplate has been operating continuously for an extended period.	The automatic safety switch-off function has been activated.
<b>F 10</b>	The metal grease filter is saturated.	Clean the metal grease filter.
<b>F 11</b>	The activated charcoal filter is saturated.	Replace the activated charcoal filter.
<b>E9000</b> <b>E90 10</b>	The operating voltage is incorrect/outside of the normal operating range.	Contact your electricity provider.
<b>U400</b>	The hob is not connected correctly	Disconnect the hob from the power supply. Ensure that it has been connected in accordance with the circuit diagram.
<b>dE</b>	Demo mode is activated	Disconnect the hob from the power supply. Wait 30 seconds and reconnect it. Touch any touch control in the next three minutes. Demo mode is deactivated.

Do not place hot pans on the control panel.

### Notes

- If **E** appears in the display, the sensor for the relevant hotplate must be pressed and held in order to read the fault code.
- If the fault code is not listed in the table, disconnect the hob from the power supply, wait 30 seconds and connect it again. If the display appears again, contact technical after-sales and tell them the precise fault code.

## Customer service

Our after-sales service is there for you if your appliance needs to be repaired. We will always find an appropriate solution, also in order to avoid after-sales personnel having to make unnecessary visits.

### E number and FD number

Please quote the E-number (product number) and the FD number (production number) of your appliance when contacting the after-sales service.

The rating plate bearing these numbers can be found:

- On the appliance certificate.
- On the underside of the hob.

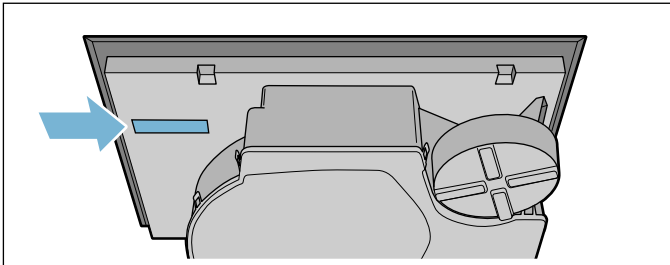
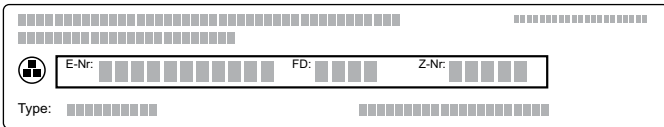

The E number can also be found on the hob's glass ceramic surface. You can check the after-sales service index (KI) and FD number by going to the basic settings. Refer to the section entitled → "Basic settings" to find out how to do this.

Please note that a visit from an after-sales service engineer is not free of charge in the event of misuse of the appliance, even during the warranty period.

Please find the contact data of all countries in the enclosed customer service list.

### To book an engineer visit and product advice

**GB** 0344 892 8989

Calls charged at local or mobile rate.

**IE** 01450 2655

0.03 € per minute at peak. Off peak 0.0088 € per minute.

Rely on the professionalism of the manufacturer. You can therefore be sure that the repair is carried out by trained service technicians who carry original spare parts for your appliances.

## Test dishes

This table has been produced for test institutes to facilitate the testing of our appliances.

The data in the table refer to our Schulte-Ufer cookware accessories (4-piece cooking set for induction hob Z9442X0) with the following dimensions:

- Saucepan: 16 cm Ø, 1.2 l for 14.5 cm Ø hotplates
- Pot: 16 cm Ø, 1.7 l for 14.5 cm Ø hotplates
- Pot: 22 cm Ø, 4.2 l, for 18 cm Ø hotplates
- Pan: 24 cm Ø, for 18 cm Ø hotplates

Test dishes	Cookware	Heat setting	Preheating		Cooking	
			Cooking time (min:sec)	Lid	Heat setting	Lid
<b>Melting chocolate</b>						
Chocolate coating (e.g. Dr. Oetker brand, dark chocolate 55% cocoa, 150 g)	Saucepan, 16 cm diameter	-	-	-	1.	No
<b>Heating and keeping lentil stew warm</b>						
Lentil stew*						
Initial temperature 20 °C						
Amount: 450 g	Cooking pot, 16 cm diameter	9	1:30 (without stirring)	Yes	1.	Yes
Amount: 800 g	Saucepan, 22 cm diameter	9	2:30 (without stirring)	Yes	1.	Yes
Lentil stew from a tin						
E.g lentils with Erasco sausages.						
Initial temperature 20 °C						
Amount: 500 g	Cooking pot, 16 cm diameter	9	Approx. 1:30 (stir after approx. 1 minute)	Yes	1.	Yes
Amount: 1 kg	Saucepan, 22 cm diameter	9	Approx. 2:30 (stir after approx. 1 minute)	Yes	1.	Yes
<b>Preparing Béchamel sauce</b>						
Temperature of the milk: 7 °C						
Ingredients: 40 g butter, 40 g flour, 0.5 l milk (3.5% fat content) and a pinch of salt						
1. Melt the butter, stir in the flour and salt, and heat up the mixture.	Saucepan, 16 cm diameter	2	Approx. 6:00	No	-	-
2 Add the milk to the roux and bring to the boil, stirring continuously.		7	Approx. 6:30	No	-	-
3. Once the Béchamel sauce comes to the boil, leave it on the hotplate for a further two minutes, stirring continuously.		-	-	-	2	No
*Recipe in accordance with DIN 44550						
**Recipe in accordance with DIN EN 60350-2						

Test dishes	Cookware	Heat setting	Preheating		Cooking	
			Cooking time (min:sec)	Lid	Heat setting	Lid
<b>Cooking rice pudding</b>						
Rice pudding, cooked with the lid on Temperature of the milk: 7 °C Heat the milk until it starts to rise up. Set the recommended heat setting and add rice, sugar and salt to the milk. The cooking time, including preheating, is approx. 45 minutes.						
Ingredients: 190 g short-grain rice, 90 g sugar, 750 ml milk (3.5% fat content) and 1 g salt	Cooking pot, 16 cm diameter	8.	Approx. 5:30	No	3 (stir after 10 minutes)	Yes
Ingredients: 250 g short-grain rice, 120 g sugar, 1 l milk (3.5% fat content) and 1.5 g salt	Saucepan, 22 cm diameter	8.	Approx. 5:30	No	3 (stir after 10 minutes)	Yes
Rice pudding, cooked without lid Temperature of the milk: 7 °C Add the ingredients to the milk and heat the mixture up while stirring continuously. Once the milk has reached approx. 90 °C, select the recommended heat setting and leave it to simmer on a low heat for approx. 50 minutes.						
Ingredients: 190 g short-grain rice, 90 g sugar, 750 ml milk (3.5% fat content) and 1 g salt	Cooking pot, 16 cm diameter	8.	Approx. 5:30	No	3	No
Ingredients: 250 g short-grain rice, 120 g sugar, 1 l milk (3.5% fat content) and 1.5 g salt	Saucepan, 22 cm diameter	8.	Approx. 5:30	No	2.	No
<b>Cooking rice*</b>						
Water temperature: 20 °C						
Ingredients: 125 g long grain rice, 300 g water and a pinch of salt	Cooking pot, 16 cm diameter	9	Approx. 2:30	Yes	2	Yes
Ingredients: 250 g long grain rice, 600 g water and a pinch of salt	Saucepan, 22 cm diameter	9	Approx. 2:30	Yes	2.	Yes
<b>Roasting a pork loin</b>						
Initial temperature of the loin: 7 °C						
Amount: 3 pork loins (total weight approx. 300 g, 1 cm thick) and 15 ml sunflower oil	Frying pan, 24 cm diameter	9	Approx. 1:30	No	7	No
<b>Preparing pancakes**</b>						
Amount: 55 ml batter for each pancake	Frying pan, 24 cm diameter	9	Approx. 1:30	No	7	No
<b>Deep-fat frying chips</b>						
Amount: 1.8 l sunflower oil, per portion: 200 g frozen chips (e.g. McCain 123 Original fries)	Saucepan, 22 cm diameter	9	Until the oil temperature reaches 180 °C	No	9	No
*Recipe in accordance with DIN 44550						
**Recipe in accordance with DIN EN 60350-2						









Constructa Neff  
Vertriebs-GmbH  
Carl-Wery-Straße 34  
D-81739 München

Register your product online

[www.neff-international.com](http://www.neff-international.com)



9001240858  
961020  
en