

The background of the page is a photograph of a dining room. A long, rustic wooden table is set for a meal with plates, glasses, and lit candles. The room has large windows and modern black pendant lights. A white box with text is overlaid on the bottom right of the image.

Induction hob

A white line drawing of a cooking pot is overlaid on the bottom left of the page. The pot has a lid with a handle and a side handle. The lid features a detailed illustration of a plant with large, serrated leaves and small flowers, possibly a herb like basil or dill.

[en] User manual

2

T6..S6...

Further information and explanations are available online:



Table of contents

| | | |
|----|--|----|
| 1 | Safety | 2 |
| 2 | Avoiding material damage..... | 4 |
| 3 | Environmental protection and saving energy | 5 |
| 4 | Suitable cookware..... | 5 |
| 5 | Familiarising yourself with your appliance | 7 |
| 6 | TwistPad® | 8 |
| 7 | Basic operation | 8 |
| 8 | FlexZone | 10 |
| 9 | Extended FlexZone | 11 |
| 10 | PowerMove | 11 |
| 11 | Time-setting options..... | 12 |
| 12 | PowerBoost | 13 |
| 13 | PanBoost | 13 |
| 14 | Keep-warm function..... | 13 |
| 15 | PowerTransfer | 14 |
| 16 | Frying Sensor..... | 14 |
| 17 | Childproof lock..... | 16 |
| 18 | Wipe protection..... | 16 |
| 19 | Individual safety switch-off | 16 |
| 20 | Basic settings..... | 16 |
| 21 | Cookware test | 18 |
| 22 | Cleaning and servicing..... | 18 |
| 23 | Troubleshooting..... | 19 |
| 24 | Disposal..... | 20 |
| 25 | Customer Service..... | 20 |
| 26 | Test dishes | 20 |

1 Safety

Observe the following safety instructions.

1.1 General information

- Read this instruction manual carefully.

- Keep the instructions, the appliance pass and the product information safe for future reference or for the next owner.
- Do not connect the appliance if it has been damaged in transit.

1.2 Intended use

Only a licensed professional may connect appliances without plugs. Damage caused by incorrect connection is not covered under the warranty.

The appliance can only be used safely if it is correctly installed according to the safety instructions. The installer is responsible for ensuring that the appliance works perfectly at its installation location.

Only use this appliance:

- To prepare meals and drinks.
- Under supervision. Never leave the appliance unattended when cooking for short periods.
- In private households and in enclosed spaces in a domestic environment.
- Up to an altitude of max. 4000 m above sea level.

Do not use the appliance:

- With an external timer or a separate remote control. This does not apply if operation with appliances included in EN 50615 is switched off.

If you wear an active implantable medical device (e.g. a pacemaker or defibrillator), check with your doctor that it complies with Council Directive 90/385/EEC of 20th June 1990, EN 45502-2-1 and EN 45502-2-2, and that it has been chosen, implanted and programmed in accordance with VDE-AR-E 2750-10. If these conditions are satisfied, and if, in addition, non-metal cooking utensils and cookware with non-metal handles are used, it is safe to use this induction hob as intended. If these conditions are satisfied, and if, in addition, non-metal cooking utensils and cookware with non-metal handles are used, it is safe to use this induction hob as intended.

1.3 Restriction on user group

This appliance may be used by children aged 8 or over and by people who have reduced physical, sensory or mental abilities or inadequate experience and/or knowledge, provided that they are supervised or have been instructed on how to use the appliance safely and have understood the resulting dangers.

Do not let children play with the appliance. Children must not perform cleaning or user maintenance unless they are at least 15 years old and are being supervised.

Keep children under the age of 8 years away from the appliance and power cable.

1.4 Safe use

⚠ WARNING – Risk of fire!

Leaving fat or oil cooking on an unattended hob can be dangerous and may lead to fires.

- ▶ Never leave hot oil or fat unattended.
- ▶ Never attempt to extinguish a fire using water; instead, switch off the appliance and then cover with a lid or a fire blanket.

The cooking surface becomes very hot.

- ▶ Never place flammable objects on the cooking surface or in its immediate vicinity.
- ▶ Never place objects on the cooking surface.

The appliance will become hot.

- ▶ Do not keep combustible objects or aerosol cans in drawers directly underneath the hob.

Hob covers can cause accidents, for example due to overheating, catching fire or materials shattering.

- ▶ Do not use hob covers.

After every use, switch off the hob using the main switch.

- ▶ Do not wait until the hob turns off automatically as there are no longer any pots and pans on it.

Food may catch fire.

- ▶ The cooking process must be monitored. A short process must be monitored continuously.

⚠ WARNING – Risk of burns!

The appliance and its parts that can be touched become hot during use, particularly the hob surround, if fitted.

- ▶ Caution should be exercised here in order to avoid touching heating elements.
- ▶ Young children under 8 years of age must be kept away from the appliance.

Hob protective grilles may cause accidents.

- ▶ Never use hob protective grilles.

The appliance becomes hot during operation.

- ▶ Allow the appliance to cool down before cleaning.

Metal objects on the hob quickly become very hot.

- ▶ Never place metal objects (such as knives, forks, spoons and lids) on the hob.

⚠ WARNING – Risk of electric shock!

Incorrect repairs are dangerous.

- ▶ Repairs to the appliance should only be carried out by trained specialist staff.
- ▶ Only use genuine spare parts when repairing the appliance.
- ▶ If the power cord of this appliance is damaged, it must be replaced with a special connection cable, which is available from the manufacturer or his Customer Service.

If the appliance or the power cord is damaged, this is dangerous.

- ▶ Never operate a damaged appliance.
- ▶ If the surface is cracked, you must switch off the appliance in order to prevent a possible electrical shock. To do this, switch off the appliance via the fuse in the fuse box rather than at the main switch.
- ▶ Never pull on the power cord to unplug the appliance. Always unplug the appliance at the mains.
- ▶ If the appliance or the power cable is damaged, immediately switch off the fuse in the fuse box.

- ▶ Call customer services. → *Page 20*

An ingress of moisture can cause an electric shock.

- ▶ Do not use steam- or high-pressure cleaners to clean the appliance.

The insulation on cables of electrical appliances may melt if it touches hot parts of the appliance.

- ▶ Never bring electrical appliance cables into contact with hot parts of the appliance.

If metallic objects come into contact with the fan that is located on the underside of the hob, this may cause an electric shock.

- ▶ Do not store long, pointed metallic objects in the drawers below the hob.

⚠ WARNING – Risk of injury!

Saucepans may suddenly jump due to liquid between the saucepan base and the hotplate.

- ▶ Always keep hotplates and saucepan bases dry.
- ▶ Never use icy-cold cookware that has been in the freezer.

When cooking in a bain marie, the hob and cooking container could shatter due to over-heating.

- ▶ The cooking container in the bain marie must not directly touch the bottom of the water-filled pot.
- ▶ Only use heat-resistant cookware.

An appliance with a cracked or broken surface can cause cuts.

- ▶ Do not use the appliance if it has a cracked or broken surface.

⚠ WARNING – Danger: Magnetism!

The removable control element is magnetic and may affect electronic implants, e.g. heart pacemakers or insulin pumps.

- ▶ Persons with electronic implants must stand at least 10 cm away from the magnetic control element. Never put the control element in your pockets.

⚠ WARNING – Risk of suffocation!

Children may put packaging material over their heads or wrap themselves up in it and suffocate.

- ▶ Keep packaging material away from children.
- ▶ Do not let children play with packaging material.

Children may breathe in or swallow small parts, causing them to suffocate.

- ▶ Keep small parts away from children.
- ▶ Do not let children play with small parts.

2 Avoiding material damage

This is where you can find the most common causes of damage and tips on how to avoid them.

| Damage | Cause | Measure |
|--|--|---|
| Stains | Unsupervised cooking process. | Monitor the cooking process. |
| Stains, blisters | Spilled food, especially food with a high sugar content. | Remove immediately with a glass scraper. |
| Stains, blisters or fractures in the glass | Defective cookware, cookware with melted enamel or cookware with copper or aluminium base. | Use suitable cookware that is in a good condition. |
| Stains, discolouration | Unsuitable cleaning methods. | Only use cleaning agents that are suitable for glass ceramic, and only clean the hob when it is cold. |
| Blisters or fractures in the glass | Knocks or falling cookware, cooking accessories or other hard or pointed objects. | When cooking, do not hit the glass or let objects fall onto the hob. |
| Scratches, discolouration | Rough cookware bases or moving the cookware on the hob. | Check the cookware. Lift the cookware when moving it. |
| Scratches | Salt, sugar or sand. | Do not use the hob as a work surface or storage space. |
| Damage to the appliance | Cooking with frozen cookware. | Never use frozen cookware. |
| Damage to the cookware or the appliance | Cooking without contents. | Never place or heat empty cookware on a hot cooking zone. |
| Glass damage | Melted material on the hot cooking zone or hot pot lid on the glass. | Do not place greaseproof paper or aluminium foil nor plastic containers or pot lids on the hob. |

| Damage | Cause | Measure |
|-------------|---|--|
| Overheating | Hot cookware on the control panel or on the frame. | Never place hot cookware on these areas. |
| Scratches | Material residue between the hob and the rotary knob TwistPad®. | Keep the rotary knob TwistPad® contact area clean. |

ATTENTION!

A fan is located on the underside of this hob.

- ▶ If a drawer is located on the underside of the hob, do not store any small or pointed objects, paper or tea towels in it. These objects may be sucked in and damage the fan or impair the cooling.
- ▶ There must be a clearance of at least 2 cm between the contents of the drawer and the fan entry point.

3 Environmental protection and saving energy

3.1 Disposing of packaging

The packaging materials are environmentally compatible and can be recycled.

- ▶ Sort the individual components by type and dispose of them separately.

3.2 Saving energy

If you follow these instructions, your appliance will use less energy.

Select the cooking zone to match the size of your pan. Centre the cookware on the hob.

Use cookware whose base diameter is the same diameter as the hotplate.

Tip: Cookware manufacturers often give the upper diameter of the saucepan. It is often larger than the base diameter.

- Unsuitable cookware or incompletely covered cooking zones consume a lot of energy.

Cover saucepans with suitable lids.

- Cooking without a lid consumes considerably more energy.

Lift lids as infrequently as possible.

- When you lift the lid, a lot of energy escapes.

Use a glass lid.

- You can see into the pan through a glass lid without having to lift it.

Use pots and pans with flat bases.

- Uneven bases increase energy consumption.

Use cookware that is suitable for the quantity of food.

- Large items of cookware containing little food need more energy to heat up.

Cook with only a little water.

- The more water that is contained in the cookware, the more energy is required to heat it up.

Turn down to a lower power level early on.

- If you use an ongoing power level that is too high, you will waste energy.

Product Information according (EU) 66/2014 can be found on the attached appliance pass and online on the product page for your appliance.

4 Suitable cookware

Cookware that is suitable for induction cooking must have a ferromagnetic base, i.e. it must be attracted by a magnet. The base must also match the size of the

cooking zone. If cookware is not detected on a cooking zone, place this on the cooking zone with the next smallest diameter.

4.1 Size and characteristics of the cookware

To correctly detect the cookware, take the size and the material of the cookware into consideration. All cookware bases must be perfectly flat and smooth.

You can use Cookware test to check whether your cookware is suitable. You can find more information about this under

→ "Cookware test", Page 18.

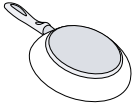
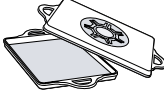
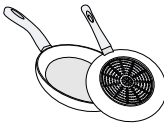
| Cookware | Materials | Properties |
|--|--|--|
| Recommended cookware | Stainless steel cookware in a sandwich design that distributes the heat well. | This cookware distributes the heat evenly, heats up quickly, and ensures that it can be detected easily. |
|  | Ferromagnetic cookware made of enamelled steel, cast iron or special induction cookware made of stainless steel. | This cookware heats up quickly and ensures that it can be detected easily. |
| Suitable | The base is not fully ferromagnetic. | If the ferromagnetic area is smaller than the base of the cookware, only the area that is ferromagnetic heats up. As a result, the heat is not distributed evenly. |
|  | Cookware bases with aluminium content. | These reduce the ferromagnetic area, which means that less power is emitted to the cookware. This cookware may not be sufficiently detected or may not be detected at all, and therefore does not heat sufficiently. |
|  | Cookware made from normal thin steel, glass, clay, copper or aluminium. | |
| Not suitable | | |

Notes

- Do not use adapter plates between the hob and the cookware.
- Do not heat up empty cookware and do not use cookware with a thin base, as this may become very hot.

5 Familiarising yourself with your appliance

5.1 Cooking with induction

In comparison to conventional hobs, induction technology brings with it a series of changes and has a number of benefits such as time savings when cooking and

frying, energy savings as well as greater ease of cleaning and care. It also offers improved heat control as the heat is generated directly in the cookware.

5.2 Control panel

Individual details, such as colour and shape, may differ from the figure.

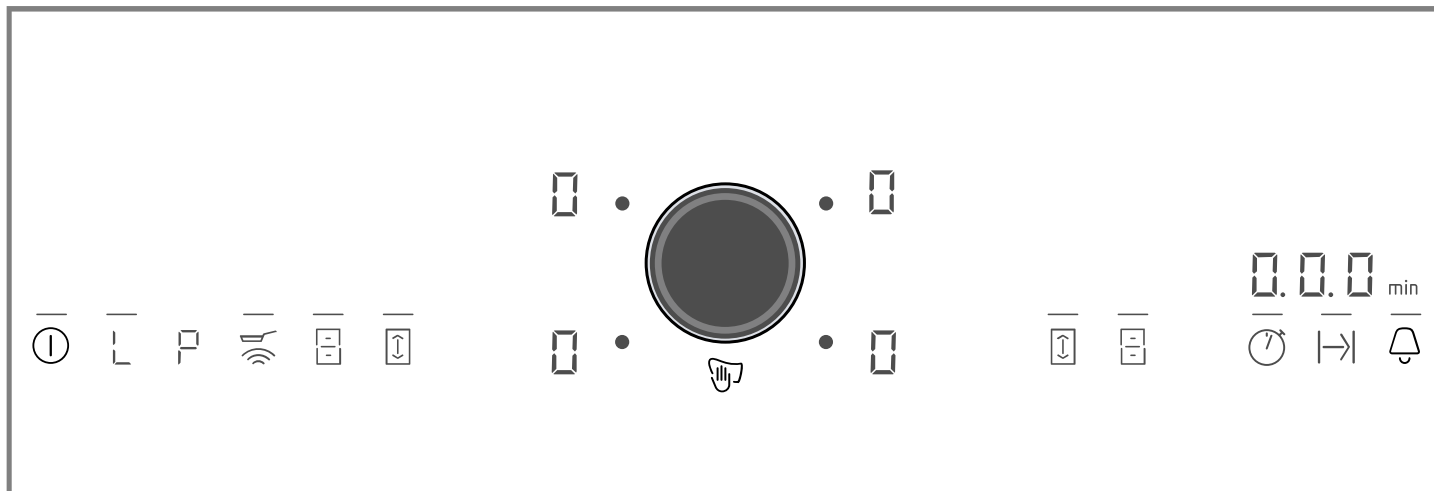

Tips

- Always keep the control panel clean and dry.
- Do not place any cookware near the displays or sensors. The electronics may overheat.

Selection sensors

When you switch on the hob, the controls that are available at this time light up.

| Sensor | Function |
|--------|-------------------------|
| ⓘ | Main switch |
| L | Keep-warm function |
| P | PowerBoost / PanBoost |
| 🔥 | Frying Sensor |
| ⏸ | FlexZone |
| ↔ | PowerMove |
| ⌚ | Runtime |
| ⏸ | Switch-off timer |
| 🔔 | Timer / Childproof lock |

Depending on the status of the hob, the displays for the cooking zones and the various activated and available functions also light up.

5.3 Distribution of the cooking zones

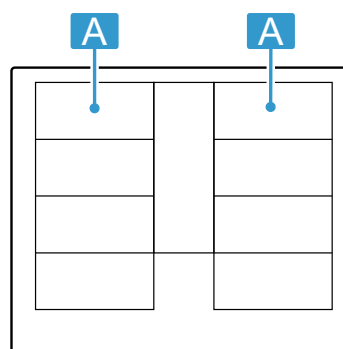

The specified power has been measured with the standard pots, which are described in IEC/EN 60335-2-6. The power may vary depending on the size of the cookware or cookware material.



| Area | Highest power level | |
|----------|---------------------|--------|
| A [Icon] | Power level 9 | 2200 W |
| | PowerBoost | 3700 W |
| A [Icon] | Power level 9 | 3300 W |
| | PowerBoost | 3700 W |
| A [Icon] | Power level 9 | 2600 W |
| | PowerBoost | 3700 W |
| A [Icon] | Power level 9 | 3300 W |
| | PowerBoost | 3700 W |



5.4 Cooking zone

Before you start cooking, check whether the size of the cookware fits the cooking zone that you want to use for cooking:

| Area | Cooking zone type |
|--|---|
|  | Single-circuit cooking zone |
|  | Flex Zone → "FlexZone", Page 10 |
|  | Extended FlexZone → "Extended FlexZone", Page 11 |

5.5 Residual heat indicator

The hob has a residual heat indicator for each cooking zone. Do not touch the cooking zone if the residual heat indicator is lit.

| Display | Meaning |
|---|---------------------------|
|  | The cooking zone is hot. |
|  | The cooking zone is warm. |

6 TwistPad®

The TwistPad® control is a pull-out rotary knob which can be used to select the cooking zones and power levels. As it is magnetic, it automatically centres itself in its special programming zone.

6.1 Positioning and operating the TwistPad®

Position the rotary knob so that it is centred on the programming zone in relation to the displays that limit this zone.

To switch on a cooking zone, touch TwistPad® at the level of the required cooking zone. Turn the rotary knob to select the power level.

Note: The rotary knob still functions correctly even if the knob is not precisely centred.

Always keep the rotary knob clean. Soiling may impair its function.

6.2 Instructions for use

- A strong magnet is located inside the rotary knob. Keep the rotary knob away from magnetic data carriers such as credit cards and cards with magnetic strips. It may damage them. The magnet may also cause faults on televisions and screens.
- The rotary knob is magnetic. Metal particles stuck to the bottom may scratch the surface of the hob. Always clean the twist knob thoroughly.

6.3 Removing TwistPad®

You can remove the rotary knob from the cooking zone during the cooking process.

If you remove the controller, Wipe protection is switched on for 35 seconds. If the rotary knob is not returned to its position before this time elapses, the hob switches off.





WARNING – Risk of fire!

The hob may continue to heat up. If, during this 35 seconds, a metallic object is placed in the area of the TwistPad, the hob may continue to heat up.

- ▶ Always switch off the hob at the main switch.

6.4 Operation without rotary knob TwistPad®

You can also operate the hob without TwistPad®:



1. Switch on the hob using the main switch.
 2. Within the next 5 seconds, simultaneously press and hold  and  for 4 seconds. An audible signal sounds.
 3. Press  repeatedly until the display for the required hob lights up.
 4. Then set the required power level using  or .
- ✓ The cooking zone is switched on.

Notes

- You cannot switch on the timer without the rotary knob.
- You can always position the rotary knob in the programming zone again.

7 Basic operation

7.1 Switching on the hob

- ▶ Touch . The symbols for the cooking zones and the currently available functions light up.  light up next to the cooking zones. Set the rotary knob TwistPad® to the setting range.
- ✓ The hob is ready for use.

ReStart

- ▶ If you switch the appliance on within four seconds of switching it off, the hob operates with the settings that were previously set.

7.2 Switching the hob off

- ▶ Touch  until the displays go out.
- ✓ All cooking zones are switched off.

Note: If all of the cooking zones are switched off for longer than 15 seconds, the hob is automatically switched off.

7.3 Setting the power level in the cooking zones

The cooking zone has 17 power levels, which are displayed from 1 to 9 with intermediate values. Select the best power level for the food and the planned cooking process.

1. Select the cooking zone. To do this, touch TwistPad® at the level for the required hob.
 - ✓  lights up brighter.
2. Turn the TwistPad® until the required power level lights up in the display.
 - ✓ The power level has been set.

Note: If no cookware is placed on the cooking zone or the pot is not suitable, the selected power level flashes. After a certain period of time, the cooking zone switches itself off.

7.4 Cooking tips

- When heating up puree, cream soups or thick sauces, stir occasionally.
- To preheat, set the power level 8-9.
- When cooking with the lid on, reduce the power level as soon as you see steam escaping. The cooking result is not affected by the steam escaping.
- After cooking, place a lid on the cookware until you serve the dish.
- To cook with the pressure cooker, observe the manufacturer's instructions.
- Do not cook food for too long, otherwise nutrients will be lost. The kitchen timer enables you to set the optimal cooking time.
- Ensure that the oil does not smoke.
- To brown the food, fry it in small portions, one after the other.
- Some items of cookware may reach high temperatures while the food is cooking. You should therefore use oven gloves.
- You can find recommendations for energy-efficient cooking under → "Saving energy", Page 5

Cooking recommendations

The table shows which power level () is suitable for which food. The cooking time (⌚ min) may vary depending on the type, weight, thickness and quality of the food.

| |  | ⌚ min |
|---------------------------------|---|---------|
| Melting | | |
| Chocolate coating | 1 - 1. | - |
| Butter, honey, gelatine | 1 - 2 | - |
| Heating and keeping warm | | |
| Stew, e.g. lentil stew | 1. - 2 | - |
| Milk ¹ | 1. - 2. | - |
| Boiled sausages ¹ | 3 - 4 | - |
| Defrosting and heating | | |
| Spinach, frozen | 3 - 4 | 15 - 25 |

¹ Without lid

² Preheat to power level 8 - 8.

QuickStart

- ▶ If you place cookware on the hob before you switch it on, the cookware is detected when you switch on and the corresponding cooking zone is selected automatically. Select the power level in the next 20 seconds, or the hob switches itself off.

Changing the power level and switching off the cooking zone

1. Select the cooking zone.
2. Select the required power level or use the  to set it to TwistPad®.
 - ✓ The cooking zone's power level changes or the cooking zone switches itself off and the residual heat indicator appears.

| |  | ⌚ min |
|--|---|-----------|
| Goulash, frozen | 3 - 4 | 35 - 55 |
| Poaching, simmering | | |
| Potato dumplings ¹ | 4. - 5. | 20 - 30 |
| Fish ¹ | 4 - 5 | 10 - 15 |
| White sauces, e.g. Béchamel sauce | 1 - 2 | 3 - 6 |
| Whisked sauces, e.g. Béarnaise sauce, Hollandaise sauce | 3 - 4 | 8 - 12 |
| Boiling, steaming, braising | | |
| Rice, with double the volume of water | 2. - 3. | 15 - 30 |
| Rice pudding ² | 2 - 3 | 30 - 40 |
| Unpeeledboiled pots | 4. - 5. | 25 - 35 |
| Boiled potatoes | 4. - 5. | 15 - 30 |
| Pasta ¹ | 6 - 7 | 6 - 10 |
| Stew | 3. - 4. | 120 - 180 |
| Soups | 3. - 4. | 15 - 60 |
| Vegetables | 2. - 3. | 10 - 20 |
| Vegetables, frozen | 3. - 4. | 7 - 20 |
| Stew in a pressure cooker | 4. - 5. | - |
| Stewing | | |
| Rolled roasting joint | 4 - 5 | 50 - 65 |
| Pot roast | 4 - 5 | 60 - 100 |
| Goulash ² | 3 - 4 | 50 - 60 |
| Braising/frying with a small amount of fat ¹ | | |
| Escalope, plain or breaded | 6 - 7 | 6 - 10 |
| Escalope, frozen | 6 - 7 | 6 - 12 |
| Chops, plain or breaded | 6 - 7 | 8 - 12 |
| Steak (3 cm thick) | 7 - 8 | 8 - 12 |
| Poultry breast (2 cm thick) | 5 - 6 | 10 - 20 |

¹ Without lid

² Preheat to power level 8 - 8.

| | | ⌚ min |
|--|---------|---------|
| Poultry breast, frozen | 5 - 6 | 10 - 30 |
| Rissoles (3 cm thick) | 4. - 5. | 20 - 30 |
| Hamburgers (2 cm thick) | 6 - 7 | 10 - 20 |
| Fish and fish fillet, plain | 5 - 6 | 8 - 20 |
| Fish and fish fillet, breaded | 6 - 7 | 8 - 20 |
| Fish, breaded and frozen, e.g. fish fingers | 6 - 7 | 8 - 15 |
| Prawns and scampi | 7 - 8 | 4 - 10 |
| Sautéing fresh vegetables and mushrooms | 7 - 8 | 10 - 20 |
| Stir-fry, vegetables, meat cut in strips Asian-style | 7 - 8 | 15 - 20 |
| Frozen dishes, e.g. stir-fries | 6 - 7 | 6 - 10 |
| Pancakes, cooked one after the other | 6. - 7. | - |

¹ Without lid
² Preheat to power level 8 - 8.

| | | ⌚ min |
|--|---------|--------|
| Omelette (cooked one after the other) | 3. - 4. | 3 - 10 |
| Fried eggs | 5 - 6 | 3 - 6 |
| Deep-frying, 150–200 g per portion in 1–2 l oil, deep-fat fried in portions¹ | | |
| Frozen products, e.g. chips, chicken nuggets | 8 - 9 | - |
| Croquettes, frozen | 7 - 8 | - |
| Meat, e.g. chicken portions | 6 - 7 | - |
| Fish, breaded or battered | 6 - 7 | - |
| Vegetables, mushrooms, breaded, beer-battered or tempura | 6 - 7 | - |
| Small baked items, e.g. doughnuts, battered fruit | 4 - 5 | - |

¹ Without lid
² Preheat to power level 8 - 8.

8 FlexZone

The flexible cooking zone allows you to position cookware of any shape or size any way you like. It consists of four inductors that work independently of each other. When the flexible cooking zone is in use, only the area that is covered by cookware is activated.

8.1 Positioning the cookware

The flexible cooking zone can be configured in two ways, depending on which cookware is used. In order to guarantee good thermal detection and heat distribution, we recommend positioning the cookware in the centre, as shown in the figures.

As a connected cooking zone

Recommended for cooking with just one item of cookware.

- Position the cookware depending on the size:

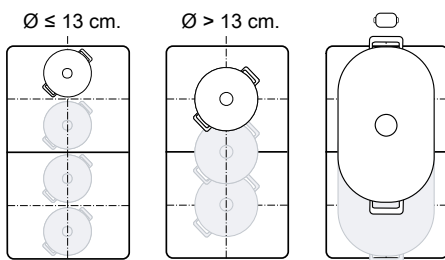

- Recommended oblong cookware



As two separate cooking zones

Recommended for cooking with two items of cookware.

You can use the front and rear zone independently of one another, and set a separate power level for each zone.

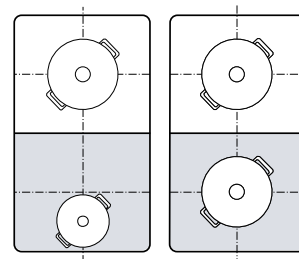

Caution

Do not place cookware in the middle between the right and left zones. The cooking zones are not activated correctly and you do not achieve a good cooking result.

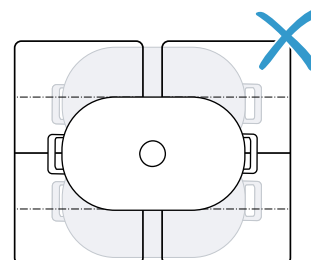

8.2 FlexZone connect

By default, the flexible zone is configured as two separate cooking zones. Switch on the following function to connect the cooking zones:

- Select one of the two cooking zones.

2. Press .

✓  lights up. The FlexZone is connected.

Note: If you move or lift the cookware from an active connected cooking zone, an automatic search starts. Each item of cookware that is found within the cooking zone during this search is heated at the previously selected power level.

9 Extended FlexZone

With the extended cooking zone, you can cook with larger cookware or position long cookware sideways on. The extension always switches on in conjunction with one of the two flexible cooking zones. You cannot switch the extension on separately.

9.1 Position the cookware according to weight and size

Position the cookware in the middle over the rear part of the flexible cooking zone and its extension. Depending on the size of the cookware and the covered cooking surface, you can switch on the flexible cooking zone as two separate cooking zones or as one connected cooking zone:

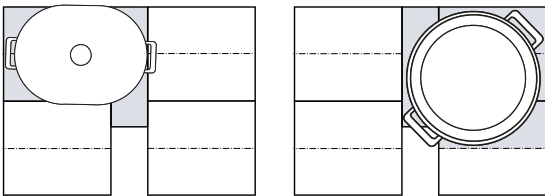

8.3 FlexZone disconnecting

- ▶ Touch .
- ✓ The cooking zones are separated and work independently of each other.

9.2 Activating Extended FlexZone

1. Place the cookware on the flexible cooking zone so that it covers the extension.
 2. Select the cooking zone and the power level. The displays for the cooking zone and  for the extended zone light up.
- ✓ The zone is activated.

Note: If the display does not light up, lift the cookware and place it back on the cooking zone.

9.3 Deactivating Extended FlexZone

- ▶ Select the cooking zone, use the button to select the cooking zone and set it to  using the Twist-Pad®.
- ✓ The function has been deactivated.



10 PowerMove

You can use this function to change the power level of an item of cookware by simply sliding it forwards or backwards in the flexible cooking zone. The zone is divided into three areas with different power levels.

10.1 Positioning and moving the cookware

Only use one item of cookware. The cooking area depends on the cookware used, as well as its size and positioning.

Each cooking area has a preset power level:

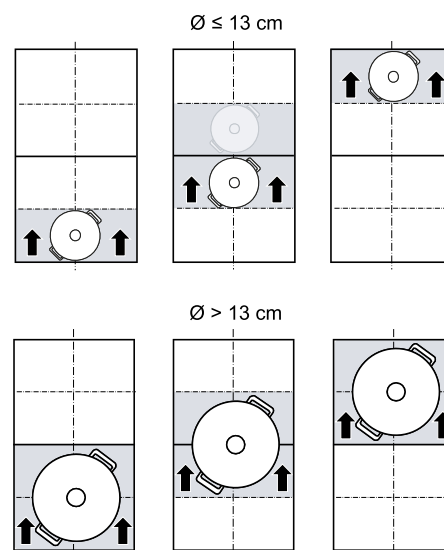

- Front area = power level 
- Middle area = power level 
- Rear area = power level 

You can change the standard setting of the preset power levels. You can find out how to do this in the "Basic settings" section → Page 16.



10.2 Activating PowerMove



Requirement: Only place one item of cookware on a flexible zone.

1. Select one of the two cooking zones in the flexible zone.
 2. Press .
- ✓  and the power level for the area in which the container is located light up.

- ✓ The function is switched on.

Note: You can change the power levels during cooking.

10.3 Deactivating PowerMove

- ▶ Touching .
- ✓  goes out.
- ✓ The function has been deactivated.

11 Time-setting options



Your hob has various functions for setting the cooking time:

- Switch-off timer
- Timer
- Runtime

11.1 Switch-off timer



Allows you to program a cooking time for one or more cooking zones. Once the time has elapsed, the cooking zone is automatically switched off.

Switching on Switch-off timer

1. Select the cooking zone and the power level.
 2. Press .
- ✓ The  indicator for the hotplate will light up.
3. Use TwistPad® to select the cooking time.
- ✓ The cooking time begins to count down.
- ✓ Once the cooking time has elapsed, the cooking zone switches itself off and an audible signal sounds.

Note: When you set a cooking time for a cooking zone in which the Frying Sensor is activated, the cooking time will not start counting down until the selected temperature level has been reached.



Changing or switching off Switch-off timer

1. Select the cooking zone and touch .
2. Use TwistPad® to change the cooking time or set to  to delete the cooking time.



11.2 Timer

Enables the activation of a timer of 0–99 minutes. This function can be used independently of the cooking zones and other settings. It does not automatically switch off the cooking zones.

Switching on Timer

1. Touch .
 2. Use TwistPad® to select the required time.
 3. Press  to confirm.
- ✓ The time begins to count down.
- ✓ An audible signal sounds and the displays flash once the time has elapsed.



Changing or switching off the Timer

1. Touch .
2. Change the running time using TwistPad® or set to  to delete the running time.
3. Press  to confirm.

11.3 Runtime

The stopwatch function displays the time that has elapsed since activation.

Switching on Runtime

- ▶ Touch .
- ✓  light up.
- ✓ The time begins to count down.

Switching off Runtime

- ▶ Touch .
- ✓ The displays for the run time programming function go out.
- ✓ The function has been deactivated.

12 PowerBoost

You can use this function to heat up large volumes of water more quickly than with **9**.

This function is available for all cooking zones, provided the other cooking zone in the same group is not in use.

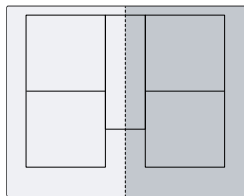

12.1 Switching on PowerBoost

1. Select the cooking zone.
2. Touch **P**. The **P** and **☑** displays light up.
 - ✓ The function is switched on.

Note: You can also switch on this function when cooking with a connected FlexZone.

12.2 Switching off PowerBoost

1. Select the cooking zone.
2. Touch **P**. The **P** and **☑** displays go out and the cooking zone switches back to power level **9**.
 - ✓ The function has been deactivated.

Note: In certain circumstances, this function may switch itself off automatically in order to protect the electronic elements inside the hob.

13 PanBoost

You can use this function to heat up pans more quickly than with **9**.

This function is available for all cooking zones, provided the other cooking zone in the same group is not in use.

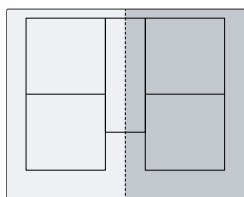

13.1 Recommended applications

- Do not place a lid on the pan.
- Never leave pans unattended when they are heating up.
- Only use cold pans.

- Use pans with a completely flat base. Do not use pans with a thin base.

13.2 Switching on PanBoost

1. Select the cooking zone.
2. Touch **P** twice. **P** and **☑** light up.
 - ✓ The function is switched on.

Note: You can also switch on this function when cooking with a connected FlexZone.

13.3 Switching off PanBoost

1. Select the cooking zone.
2. Touch **P**. **P** and **☑** go out and the cooking zone switches back to power level **9**.
 - ✓ The function has been deactivated.

Note: To avoid high temperatures, this function automatically switches itself off after 30 seconds.

14 Keep-warm function

You can use this function to melt chocolate or butter and to keep meals warm.

14.1 Switching on Keep-warm function

1. Select the required cooking zone.
2. Touch **L** within the next 10 seconds.
 - L** lights up.
 - ✓ The function is switched on.

14.2 Switching off Keep-warm function

1. Select the cooking zone.
2. Touch **L**.
 - L** goes out.
 - ✓ The function has been deactivated.

15 PowerTransfer

You can use this function to transfer the power level and the programmed cooking time from one cooking zone to another.

15.1 PowerTransfer

Requirement: Move the cookware to a cooking zone which is not switched on, which you have not yet pre-set and on which no other cookware has been placed.

1. Move the cookware.

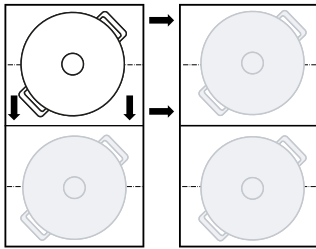

The cookware is detected and the previously selected power level and $\frac{1}{2}$ flash alternately on the display for the new cooking zone.

- Select the new cooking zone to implement the settings.
The appliance sets the power level for the original cooking zone to $\frac{1}{2}$.
✓ The settings are transferred to the new cooking zone.

Note: If you place a new item of cookware on a different cooking zone before you have confirmed the settings, you can use this function for both items of cookware.

16 Frying Sensor

Suitable for cooking or reducing sauces, pancakes or frying eggs with butter, for frying vegetables or steaks up to the required level of boiling, and for keeping the temperature under control.

Instead of frequently adjusting the power level during cooking, select the required target temperature once at the start. The sensors under the glass ceramic measure the temperature of the cookware and keep this constant throughout the entire cooking process. This function is available on all cooking zones marked with this symbol

16.1 Advantages

- The temperature is automatically kept constant without you having to change the power level.
- Oil does not overheat. This prevents the food from burning.
- The cooking zone only continues heating for as long as this is necessary to maintain the temperature. This saves energy.

16.2 Temperature levels

Temperature levels for preparing meals.

| Level | Temperature | Functions | Cookware |
|-------|-------------|---|----------|
| 1 | 120 °C | Boiling and reducing sauces, fry vegetables | |
| 2 | 140 °C | Searing in olive oil or butter | |
| 3 | 160 °C | Frying fish and coarse foods | |

| Level | Temperature | Functions | Cookware |
|-------|-------------|--|----------|
| 4 | 180 °C | Deep-fat frying breaded, frozen and grilled food | |
| 5 | 215 °C | High-temperature grill and griddle plate | |

16.3 Recommended cookware



Special cookware has been developed for this function, which delivers the best results.

| Cookware | Recommended cooking zone |
|----------------------------|--------------------------|
| Frying pan, 15 cm diameter | Single cooking zone |
| Frying pan, 19 cm diameter | Single cooking zone |
| Frying pan, 21 cm diameter | Single cooking zone |
| Frying pan, 28 cm diameter | Extended FlexZone |
| Teppanyaki | Flex Zone |
| Grill | Flex Zone |

The recommended cookware is available from customer service, specialist retailers or our online shop www.neff-international.com.

Note: You can also use other cookware. Depending on the composition of the cookware, the achieved temperature may differ from the selected temperature level.

16.4 Switching on the Frying Sensor



1. Place empty cookware on the cooking zone.
2. Select the cooking zone and touch .
3. Within the next 5 seconds, use the rotary knob TwistPad® to select the required temperature level.
 - ✓ The functions starts.  flashes until the set target temperature is reached.
 - ✓ Once the target temperature has been reached, a signal tone sounds and  stops flashing.
4. Add the frying fat and then the food to the frying pan.

Note: If you need to cook with more than 250 ml oil, add the oil and wait a few seconds before you add the food.

















































16.5 Switching off Frying Sensor



























































- ▶ Select the cooking zone and touch .
- ✓ The function has been deactivated.

16.6 Recommendations for cooking with the Frying Sensor

The following table shows the ideal temperature levels for a selection of dishes. The temperature  and the cooking time  min depend on the amount, condition and quality of the food.

-  Frying pan
-  Teppanyaki
-  Griddle plate

| | Cookware |  |  min |
|------------------------------------|---|---|---|
| Meat | | | |
| Escalope |    | 4 | 6-10 |
| Escalope, breaded |  | 4 | 6-10 |
| Fillet |    | 4 | 6-10 |
| Chops |    | 3 | 10-15 |
| Cordon bleu, Wiener Schnitzel |  | 4 | 10-15 |
| Steak, rare, 3 cm thick |    | 5 | 6-8 |
| Steak, medium, 3 cm thick |    | 5 | 8-12 |
| Steak, well-done, 3 cm thick |    | 4 | 8-12 |
| T-bone steak, rare, 4.5 cm thick |    | 5 | 10-15 |
| T-bone steak, medium, 4.5 cm thick |    | 5 | 20-30 |
| Poultry breast, 2 cm thick |    | 3 | 10-20 |
| Bacon |    | 2 | 5-8 |
| Minced meat |  | 4 | 6-10 |
| Hamburgers, 1.5 cm thick |    | 3 | 6-15 |
| Meatballs, 2 cm thick |  | 3 | 10-20 |
| Sausages |    | 3 | 8-20 |
| Chorizo, fresh sausages |    | 3 | 10-20 |
| Skewers, kebabs |    | 3 | 10-20 |
| Gyros |  | 4 | 7-12 |



| | Cookware |  |  min |
|--------------------------------------|---|---|---|
| Fish and seafood | | | |
| Fish fillet |    | 4 | 10-20 |
| Fish fillet, breaded |  | 4 | 10-20 |
| Fish, fried, whole |    | 3 | 10-20 |
| Sardines |    | 4 | 6-12 |
| Scampi, prawns |    | 4 | 4-8 |
| Squid, cuttlefish |    | 4 | 6-12 |
| Egg dishes | | | |
| Fried eggs in butter |  | 2 | 2-6 |
| Fried eggs |  | 4 | 2-6 |
| Scrambled eggs |  | 2 | 4-9 |
| Omelette |  | 2 | 3-6 |
| French toast |  | 3 | 4-8 |
| Crêpes, blinis, pancakes, tacos |  | 5 | 1-3 |
| Vegetables | | | |
| Roast potatoes |  | 5 | 6-12 |
| Chips |  | 4 | 15-25 |
| Potato pancakes |  | 5 | 2-4 |
| Onions, roasted garlic |  | 2 | 2-10 |
| Onion rings |  | 3 | 5-10 |
| Courgettes, aubergines, peppers |    | 2 | 4-12 |
| Green asparagus |    | 3 | 4-15 |
| Mushrooms |    | 4 | 10-15 |
| Vegetables, braised in oil |  | 1 | 10-20 |
| Vegetables in tempura batter |  | 4 | 5-10 |
| Frozen products | | | |
| Chicken nuggets |  | 4 | 10-15 |
| Fish fingers |  | 4 | 8-12 |
| Chips |  | 5 | 4-8 |
| Stir-fries |  | 3 | 6-10 |
| Spring rolls |  | 4 | 10-30 |
| Pastries, croquettes |  | 5 | 3-8 |
| Sauces | | | |
| Tomato sauce |  | 1 | 25-35 |
| Béchamel sauce |  | 1 | 10-20 |
| Cheese sauce |  | 1 | 10-20 |
| Sweet sauces |  | 1 | 15-25 |
| Sauces, reduced |  | 1 | 25-35 |
| Other | | | |
| Fried cheese |  | 3 | 7-10 |
| Croutons |  | 3 | 6-10 |
| Toasted bread |    | 4 | 4-8 |
| Dried ready meals |  | 1 | 5-10 |
| Almonds, walnuts, pine nuts, roasted |  | 4 | 3-15 |
| Popcorn |  | 5 | 3-4 |

17 Childproof lock

The hob is equipped with a childproof lock. This prevents children from switching on the hob.

17.1 Switching on Childproof lock

Requirement: The hob must be switched off.

- ▶ Touch and hold  for 4 seconds.
- ✓ The  display lights up for 10 seconds.
- ✓ The hob is locked.

17.2 Switching off Childproof lock

- ▶ Touch and hold  for 4 seconds.
- ✓ The lock is released.

17.3 Automatic childproof lock

You can also activate the childproof lock automatically every time the hob is switched off.

You can find out how to switch the function on and off in the "Basic settings" section → Page 16.

18 Wipe protection

Allows the control panel to be locked for cleaning so that the settings are not inadvertently adjusted. The lock has no effect on the main switch.

18.1 Switching on Wipe protection

- ▶ Remove the rotary knob TwistPad®.  lights up.
- ✓ The control panel remains locked for 35 seconds. A signal tone sounds 5 seconds before the appliance is switched off.

18.2 Switching off Wipe protection

To switch off the function early:

- ▶ Press TwistPad® and turn it until  goes out.
- ✓ The control panel is unlocked.

19 Individual safety switch-off

The safety function is activated if one cooking zone is in operation for an extended period and you do not change any settings. The cooking zone displays *FB* and switches itself off.



The time from 1 to 10 hours depends on the selected power level.

Press any button to switch on the cooking zone.

20 Basic settings

You can configure the basic settings for your appliance to meet your needs.

20.1 Overview of the basic settings

| Display | Setting | Value |
|--|--|--|
|  1 | Childproof lock | 0 - Manual. ¹ 1 - Automatic. 2 - Switched off. |
|  2 | Audible signals | 0 - Confirmation and fault signals are switched off. 1 - Only the fault signal is switched on. 2 - Only the confirmation signal is switched on. 3 - All signal tones are switched on ¹ . |
|  3 | Energy consumption display Shows the total energy consumption between switching the hob on and off in kWh. The accuracy of the display depends on various factors such as the voltage quality of the power supply. | 0 - Switched off. ¹ 1 - Switched on. |



¹ Factory setting

| Display | Setting | Value |
|---------|---|---|
| c 5 | Automatic switch-off of the cooking zones. | 0 0 – switched off. ¹ 0 1-9 9 - minutes until the appliance switches off automatically. |
| c 6 | Duration of the timer end signal tone | 1 – 10 seconds 2 – 30 seconds 3 – 1 minute ¹ . |
| c 7 | Power limitation Enables the total power of the hob to be limited, if necessary, based on the conditions of your electrical installation. The available settings depend on the maximum power of the hob. You can find precise information on the rating plate. If the function is active and the hob has reached the set power limit, _ is displayed and you cannot select a higher power level. | 0 - Switched off. Maximum power of the hob ¹ . 1 - 1000 W. Lowest power setting. 1. - 1500 W. ... 3 - 3000 W. Recommended for 13 A. 3. - 3500 W. Recommended for 16 A. 4 - 4000 W. 4. - 4500 W. Recommended for 20 A. ... 9 - Maximum power of the hob. |
| c 9 | Time for selecting the cooking zone | 0 - Unlimited: You can adjust the last selected cooking zone without having to select it again. ¹ 1 - Limited: You can adjust the last selected cooking zone within 10 seconds after selecting it. After this time, you must select the cooking zone again before adjusting it. |
| c 11 | PowerMove Allows you to change the preset power levels for the three cooking areas of the flexible cooking zone. Select one of the two cooking zones, set the required power level in the settings area and touch  to confirm the new power level and select the next cooking zone. | 9 - Preset power level for the front cooking zone. 5 - Preset power level for the middle cooking zone. L - Preset power level for the rear cooking zone. |
| c 12 | Cookware test You can use this function to test the quality of the cookware. | 0 - Not suitable. 1 - Not optimal. 2 - Suitable. |
| c 0 | Restoring factory settings | 0 - Individual settings ¹ . 1 - Factory settings. |

¹ Factory setting



20.2 To go to the basic settings

Requirement: The hob must be switched off.

1. To switch on the hob, touch .
2. Within the next 10 seconds, press and hold  for 4 seconds.

| Product information | Display |
|--|---------|
| Directory for the technical after-sales service (TK) | 0 1 |
| Production number | Fd |
| Production number 1 | 02. |
| Production number 2 | 0.5 |

- ✓ The first four displays provide the product information. To call up each display, turn the rotary knob TwistPad®.

3. Touch  to access the basic settings.
✓ c 1 and 0 light up as a presetting.
4. Touch  repeatedly until the desired setting appears.
5. Use TwistPad® to select the required setting.
6. Touch and hold  for 4 seconds.
✓ The settings are saved.

20.3 Discarding changes to the basic settings

- ▶ Touch .
- ✓ All changes are discarded and not saved.

21 Cookware test

The quality of the cookware has a major influence on the speed and the result of the cooking process. You can use this function to test the quality of the cookware.

Before the test, ensure that the size of the cookware base corresponds to the size of the cooking zone being used.

Access is via the basic settings. → Page 16

21.1 Carrying out Cookware test

As a single cooking zone, the flexible cooking zone is set in such a way that only the individual item of cookware is checked.

1. At room temperature, place the cookware with approx. 200 ml water in the centre of the cooking zone that best fits the base of the cookware in terms of size.
2. Call up the basic settings and select ϵ 12.

3. Turn TwistPad®. — flashes in the cooking zones.
 - ✓ The function is switched on.
 - ✓ After 10 seconds, the result appears in the cooking zone displays.

21.2 Checking the result

You can see what the result means for the quality and speed of the cooking process in the following table.

| Result |
|---|
|  The cookware is not suitable for the cooking zone and therefore does not heat up. |
|  The cookware is taking longer to heat up than expected and cooking is not progressing as well as it ought to. |
|  The cookware is heating up correctly and cooking is progressing well. |

To reactivate the function, turn TwistPad®.

22 Cleaning and servicing

To keep your appliance working efficiently for a long time, it is important to clean and maintain it carefully.

22.1 Cleaning products

You can obtain suitable cleaning products and glass scrapers from customer service, a retailer or the online shop www.neff-international.com.

ATTENTION!

Unsuitable cleaning products may damage the surfaces of the appliance.

- ▶ Never use unsuitable cleaning products.
- ▶ Do not use cleaning products while the hob is still hot. This may cause marks on the surface.

Unsuitable cleaning products

- Undiluted detergent
- Detergent intended for dishwashers
- Abrasive cleaning products
- Aggressive cleaning products such as oven spray or stain remover
- Abrasive sponges
- High-pressure or steam jet cleaners

22.2 Cleaning the hob

Clean the hob after every use to stop cooking residues from getting burnt on.

Requirement: The hob must be cold. Do not allow the hob to cool down if it has sugar stains, plastic or aluminium foil on it.

1. Remove heavy soiling using a glass scraper.
2. Clean the hob with a cleaning agent for glass ceramic.

Follow the cleaning instructions on the packaging of the cleaning agent.

Tip: You can achieve good cleaning results using a special sponge for glass ceramic.

22.3 Cleaning the hob surround

If the hob frame is dirty or stained after use, clean this.

Note: Do not use a glass scraper.

1. Clean the hob frame with hot soapy water and a soft cloth.
Wash new sponge cloths thoroughly before use.
2. Dry with a soft cloth.

22.4 Cleaning TwistPad®

To clean the twist knob, use lukewarm water with a little washing-up liquid.

Do not use abrasive or corrosive cleaning agents. Do not clean it in the dishwasher or immerse it in water, as this may damage it.

23 Troubleshooting

You can rectify minor faults on your appliance yourself. Read the troubleshooting information before contacting after-sales service. This will avoid unnecessary costs.

WARNING – Risk of injury!

Improper repairs are dangerous.

- ▶ Repairs to the appliance should only be carried out by trained specialist staff.
- ▶ If the appliance is defective, call Customer Service.

WARNING – Risk of electric shock!

Incorrect repairs are dangerous.

- ▶ Repairs to the appliance should only be carried out by trained specialist staff.
- ▶ Only use genuine spare parts when repairing the appliance.
- ▶ If the power cord of this appliance is damaged, it must be replaced with a special connection cable, which is available from the manufacturer or his Customer Service.

23.1 Warnings

Notes

- If \mathcal{E} appears in the display, press and hold the twist knob TwistPad® next to the mark for the relevant cooking zone in order to read the fault code.
- If the fault code is not listed in the table, disconnect the hob from the power supply and wait 30 seconds before reconnecting it. If this display appears again, contact the technical customer service and specify the exact fault code.
- If an error occurs, the appliance does not switch to standby mode.
- In order to protect the appliance's electronic parts from overheating or surge currents, the hob may temporarily reduce the power level.

23.2 Information on the display panel

| Fault | Cause and troubleshooting |
|--|--|
| No displays light up. | The power supply has been disconnected. <ul style="list-style-type: none"> ▶ Use other electrical appliances to check whether there has been a power failure. The appliance has not been connected as shown in the circuit diagram. <ul style="list-style-type: none"> ▶ Connect the appliance in accordance with the circuit diagram. Electronics fault <ul style="list-style-type: none"> ▶ If you are unable to rectify the fault, inform the technical after-sales service. |
| The displays flash. | The control panel is wet or an object is covering it. <ul style="list-style-type: none"> ▶ Dry the control panel or remove the object. |
| <i>F2, F4, E 7015, E 8207, E 8208</i> | The electronics have overheated and one or all of the cooking zones have been switched off. <ul style="list-style-type: none"> ▶ Wait until the electronics have cooled down sufficiently. Then touch any button on the control panel. |
| <i>FS</i> + power level and audible signal | There is hot cookware in the vicinity of the control panel. This may cause the electronics to overheat. <ul style="list-style-type: none"> ▶ Remove the cookware. The fault display goes out shortly afterwards. You can continue to cook. |
| <i>FS</i> and signal tone | There is hot cookware in the vicinity of the control panel. The cooking zone has been switched off to protect the electronics. <ul style="list-style-type: none"> ▶ Remove the cookware. Wait a few seconds. Touch any button. When the fault display goes out, you can continue cooking. |
| <i>F1/FE</i> | The cooking zone has overheated and has been switched off to protect the work surface. <ul style="list-style-type: none"> ▶ Wait until the electronics have cooled down sufficiently before switching the cooking zone back on. |
| <i>FQ</i> | PowerTransfer does not switch on. <ul style="list-style-type: none"> ▶ Touch any button to confirm the fault display. You can continue to cook as normal without using the PowerTransfer function. Contact customer service. |
| <i>F9</i> | Extended FlexZone does not switch on. <ul style="list-style-type: none"> ▶ Touch any sensor to confirm the fault display. You can use the remaining cooking zones to continue cooking. Contact the technical after-sales service. |
| <i>FB</i> | The cooking zone has been operating continuously for an extended period. <ul style="list-style-type: none"> ▶ Individual safety switch-off is switched on. Touch any button to switch off the display so that you can set the cooking zone again. |

| Fault | Cause and troubleshooting |
|---------------------|--|
| <i>E 9000/E9010</i> | The operating voltage is incorrect and outside of the normal operating range. ▶ Contact your energy supplier. |
| <i>U400</i> | The hob is not connected correctly. ▶ Disconnect the hob from the mains. Connect the hob in accordance with the circuit diagram. |
| <i>d E</i> | Demo mode is activated. ▶ Disconnect the hob from the mains. Wait for 30 seconds and connect the hob. Touch any sensor in the next three minutes. Demo mode is deactivated. |

23.3 Normal noises from your appliance

An induction hob may sometimes cause noises or vibrations, such as buzzing, crackling, hissing noises, fan noises or rhythmic noises.

24 Disposal

Find out here how to dispose of old appliances correctly.

24.1 Disposing of old appliance

Valuable raw materials can be reused by recycling.

1. Unplug the appliance from the mains.
2. Cut through the power cord.
3. Dispose of the appliance in an environmentally friendly manner.
Information about current disposal methods are available from your specialist dealer or local authority.



This appliance is labelled in accordance with European Directive 2012/19/EU concerning used electrical and electronic appliances (waste electrical and electronic equipment - WEEE). The guideline determines the framework for the return and recycling of used appliances as applicable throughout the EU.

25 Customer Service

If you have any queries on use, are unable to rectify faults on the appliance yourself or if your appliance needs to be repaired, contact Customer Service. Function-relevant genuine spare parts according to the corresponding Ecodesign Order can be obtained from Customer Service for a period of at least 10 years from the date on which your appliance was placed on the market within the European Economic Area.

Note: Under the terms of the manufacturer's warranty the use of Customer Service is free of charge.

Detailed information on the warranty period and terms of warranty in your country is available from our after-sales service, your retailer or on our website.

If you contact Customer Service, you will require the product number (E-Nr.) and the production number (FD) of your appliance.

The contact details for Customer Service can be found in the enclosed Customer Service directory or on our website.

25.1 Product number (E-Nr.) and production number (FD)

You can find the product number (E-Nr.) and the production number (FD) on the appliance's rating plate.

The rating plate can be found:

- on the appliance certificate.
- on the lower section of the hob.

The product number (E no.) can also be found on the glass ceramic. You can also display the customer service index (KI) and the production number (FD) in the basic settings. → *Page 16*

Make a note of your appliance's details and the Customer Service telephone number to find them again quickly.

26 Test dishes

These recommended settings are intended for test institutes to facilitate the testing of our appliances. The tests were carried out using our cookware sets for in-

duction hobs. If required, these accessory sets can be purchased at a later point from specialist retailers, or through our technical after-sales service or our online shop.

26.1 Melting the chocolate coating

Ingredients: 150 g dark chocolate (55% cocoa).

- 16 cm saucepan without lid
 - Boiling: Power level 1.

26.2 Heating and keeping lentil stew warm

Recipe in accordance with DIN 44550

Initial temperature 20 °C

Heating up without stirring

- 16 cm saucepan with lid, amount: 450 g
 - Heating up: Duration 1 min. 30 sec., power level 9
 - Simmering: Power level 1.
- 20 cm saucepan with lid, amount: 800 g
 - Heating up: Duration 2 min. 30 sec., power level 9
 - Simmering: Power level 1.

26.3 Heating and keeping lentil stew warm

E.g.: Lentil diameter 5–7 mm. Initial temperature 20 °C

Stir after heating for 1 minute

- 16 cm saucepan with lid, amount: 500 g
 - Heating up: Duration approx. 1 min. 30 sec., power level 9
 - Simmering: Power level 1.
- 20 cm saucepan with lid, amount: 1 kg
 - Heating up: Duration approx. 2 min. 30 sec., power level 9
 - Simmering: Power level 1.

26.4 Béchamel sauce

Milk temperature: 7 °C

- 16 cm saucepan without lid, ingredients: 40 g butter, 40 g flour, 0.5 l milk with 3.5% fat content and a pinch of salt

Preparing Béchamel sauce

1. Melt the butter, stir in the flour and salt, and heat up the mixture.
 - Heating up: Duration 6 min., power level 2
2. Add the milk to the roux and bring to the boil, stirring continuously.
 - Heating up: Duration 6 min. 30 sec., power level 7
3. Once the Béchamel sauce comes to the boil, leave it on the cooking zone for a further two minutes.
 - Simmering: Power level 2

26.5 Cooking rice pudding with the lid on

Milk temperature: 7 °C

1. Heat the milk until it starts to rise up. Heat up without a lid. Stir after heating for 10 min.
2. Set the recommended power level and add rice, sugar and salt to the milk.

The cooking time, including heating up, is approx. 45 minutes.

- 16 cm saucepan, ingredients: 190 g short-grain rice, 90 g sugar, 750 ml milk with 3.5% fat content and 1 g salt
 - Heating up: Duration approx. 5 min. 30 sec., power level 8.
 - Simmering: Power level 3
- 20 cm saucepan, ingredients: 250 g short-grain rice, 120 g sugar, 1 l milk with 3.5% fat content and 1.5 g salt
 - Heating up: Duration approx. 5 min. 30 sec., power level 8.
 - Simmering: Power level 3, stir after 10 minutes

26.6 Cooking rice pudding without a lid

Milk temperature: 7 °C

1. Add the ingredients to the milk and heat the mixture up while stirring continuously.
2. Once the milk has reached approx. 90 °C, select the recommended power level and leave it to simmer on a low heat for approx. 50 minutes.

- 16 cm saucepan without lid, ingredients: 190 g short-grain rice, 90 g sugar, 750 ml milk with 3.5% fat content and 1 g salt
 - Heating up: Duration approx. 5 min. 30 sec., power level 8.
 - Simmering: Power level 3
- 20 cm saucepan without lid, ingredients: 250 g short-grain rice, 120 g sugar, 1 l milk with 3.5% fat content and 1.5 g salt
 - Heating up: Duration approx. 5 min. 30 sec., power level 8.
 - Simmering: Power level 2.

26.7 Cooking rice

Recipe in accordance with DIN 44550

Water temperature: 20 °C

- 16 cm saucepan with lid, ingredients: 125 g long-grain rice, 300 g water and a pinch of salt
 - Heating up: Duration approx. 2 min. 30 sec., power level 9
 - Simmering: Power level 2
- 20 cm saucepan with lid, ingredients: 250g long-grain rice, 600 g water and a pinch of salt
 - Heating up: Duration approx. 2 min. 30 sec., power level 9
 - Simmering: Power level 2.

26.8 Roasting a pork loin

Initial temperature of the loin: 7 °C

- 24 cm pan without lid, ingredients: 3 pork loins, total weight approx. 300 g, 1 cm thick, and 15 g sunflower oil
 - Heating up: Duration approx. 1 min. 30 sec., power level 9
 - Simmering: Power level 7

26.9 Preparing crêpes

Recipe in accordance with DIN EN 60350-2

- 24 cm pan without lid, ingredients: 55 ml batter per crêpe
 - Heating up: Duration 1 min. 30 sec., power level 9
 - Simmering: Power level 7

26.10 Deep-fat frying frozen chips

- Pot dia. 20 cm without lid: ingredients: 2 l sunflower oil. For each frying time: 200 g frozen chips, 1 cm thick.
 - Heating up: Power level 9, until the oil temperature reaches 180 °C.
 - Simmering: Power level 9

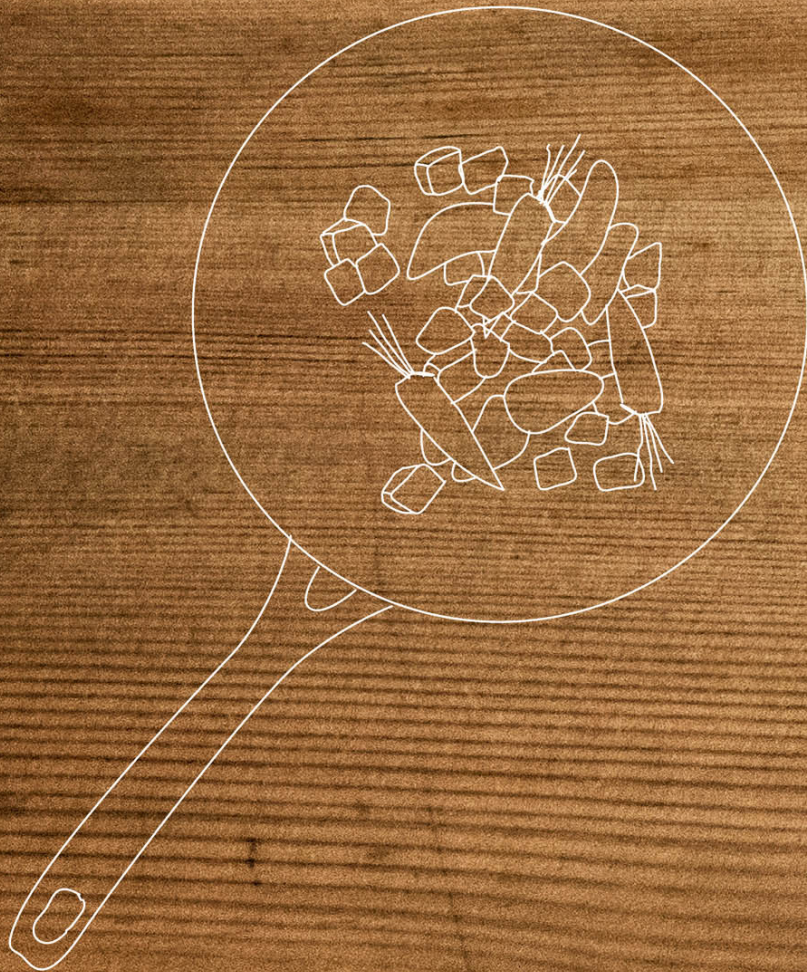

REGISTER YOUR PRODUCT
ONLINE NEFF-HOME.COM

BSH Hausgeräte GmbH
Carl-Wery-Straße 34
81739 München, GERMANY

Valid within Great Britain:
Imported to Great Britain by
BSH Home Appliances Ltd.
Grand Union House
Old Wolverton Road
Wolverton, Milton Keynes
MK12 5PT
United Kingdom



9001697211
020321
en