

**How to connect up,
build-in, set up, use and
look after your
U1421 oven**

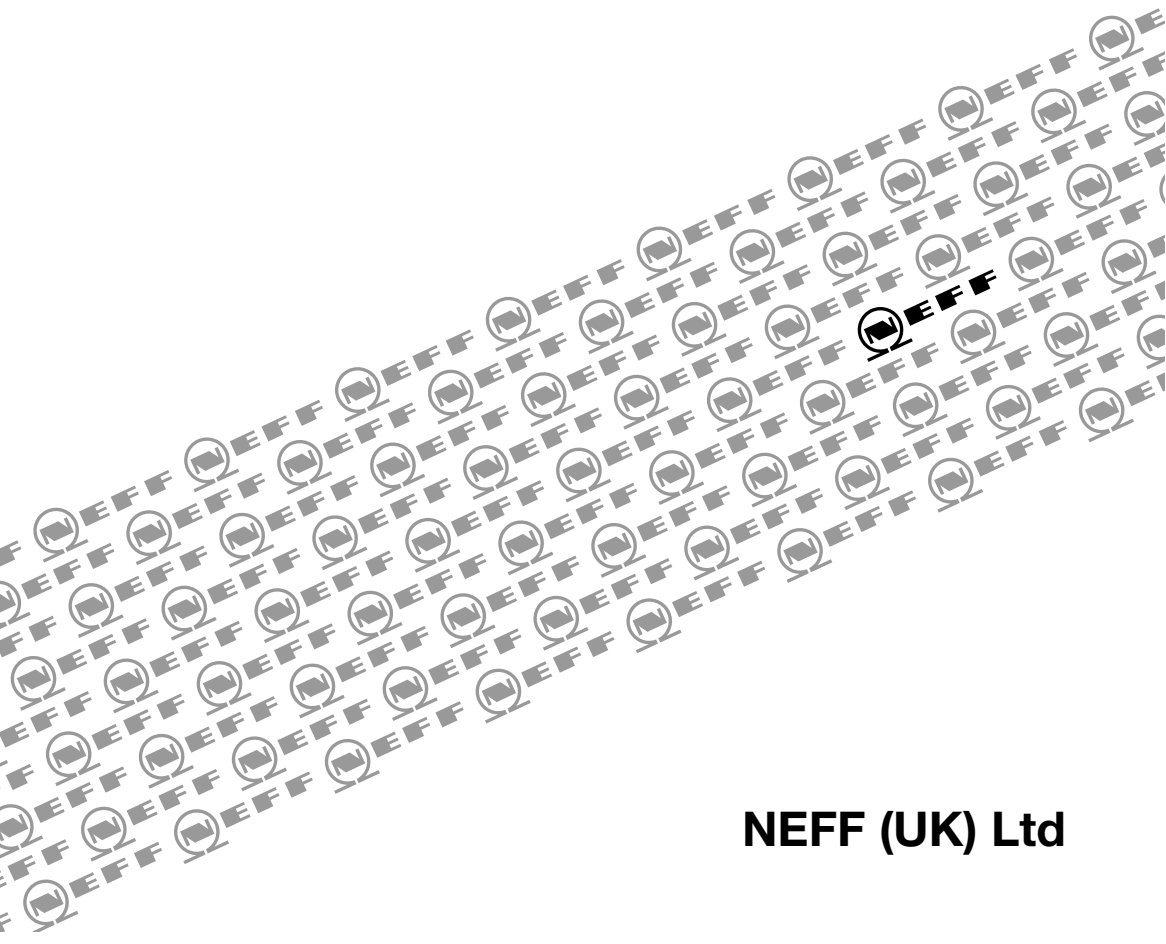

NEFF (UK) Ltd

Table of Contents

	Page		Page
Important Information		Cleaning and Care	
<input type="checkbox"/> Notes on disposal	3	<input type="checkbox"/> Important cleaning basics	18
<input type="checkbox"/> Before connecting your new appliance	3	<input type="checkbox"/> Enamel and glass	18
<input type="checkbox"/> Appliance safety considerations	4	<input type="checkbox"/> Stainless steel front	18
Introducing: Your New Oven		<input type="checkbox"/> Oven interior	18
<input type="checkbox"/> Control panel overview	5	<input type="checkbox"/> Removing/installing the oven door	19
<input type="checkbox"/> Accessories	6	<input type="checkbox"/> Oven light	19
<input type="checkbox"/> Shelf positions	6	<input type="checkbox"/> Removing shelf railings – Main oven	19
Before Using Your Appliance for the First Time		<input type="checkbox"/> Removing shelf railings – Mini oven	19
<input type="checkbox"/> Setting the time of day	7	Service and Repair Information	20
<input type="checkbox"/> Preliminary cleaning	7	Trouble-shooting Guide	21
<input type="checkbox"/> Initial burn-in	7	Assembly Instructions	
Electronic Timer		<input type="checkbox"/> For the installer and kitchen expert	22
<input type="checkbox"/> Minute timer	8	<input type="checkbox"/> Installation of the built-in oven	23
<input type="checkbox"/> Automatic timer	9+10		
<input type="checkbox"/> Special functions	10		
<input type="checkbox"/> Information	10		
Baking Roasting and Grilling			
<input type="checkbox"/> Definition of Oven Features	11		
<input type="checkbox"/> Switching the oven ON and OFF	12		
<input type="checkbox"/> Baking – Main oven	13		
<input type="checkbox"/> Roasting – Main oven	14		
<input type="checkbox"/> Roasting – Mini oven	15		
<input type="checkbox"/> Grilling – Mini oven	15		
Cooking Tips and Helpful Hints	16		
Defrosting and Cooking – Main oven	17		

Notes on disposal

- ❑ Old appliances still have some residual value. An environment-friendly method of disposal will ensure that valuable raw materials can be recovered and used again.
Before you dispose of your old appliance, make sure that it has been rendered inoperable.
- ❑ Your new appliance was protected by suitable packaging while it was on its way to you. All materials used for this purpose are environment-friendly and suitable for recycling. Please make a contribution to protecting the environment by disposing of the packaging appropriately.
Up-to-date information concerning options for disposing of your old appliance and the packaging from the new one can be obtained from your retailer or local government office.

Before connecting your new appliance

- ❑ Before using your new appliance, please read these Instructions for use carefully. They contain important information concerning your personal safety as well as on use and care of the appliance.
- ❑ The Instructions for Use apply to several versions of this appliance. Accordingly, you may find descriptions of individual features that do not apply to your specific appliance.
- ❑ Please keep the operating and installation instructions in a safe place; this important documentation may also be of use to a possible subsequent owner.
- ❑ Do not use the appliance if it is damaged in any way.
- ❑ Installation and connection of the appliance should be performed according to the instructions and connection diagram provided, and should be entrusted to a competent electrician. In the event of a damage that occurs as a result of improper connection, the warranty will be void.
- ❑ Our appliances meet the applicable safety regulations for electrical appliances. Repairs must only be performed by service engineers trained by the manufacturer. Repairs carried out by incompetent service agents can make the appliance unsafe.

Appliance safety considerations

- The appliance should only be used for the preparation of food.

-



Open the oven door carefully.
Hot steam may escape.

- The surfaces of heating and cooking appliances get hot during operation. The interior oven walls and the heating elements get extremely hot. Always keep children away from the appliance.
- Never leave the appliance unattended when cooking with fat or oil. They can catch fire if overheated.
- Clean the oven regularly. Fatty or oily remnants could ignite when the oven is switched on.
- Make sure that the power cord does not get caught in the hot oven door. The plastic insulation could melt.
- In the case of a defect, switch off (or remove) the mains fuse in the building electrical system.
- Do not store combustible items in the oven. They could ignite if the oven is switched on accidentally.
- Do not clean the oven with steam or high-pressure cleaners.
- If using the Main oven, do not place greaseproof paper loosely in the oven (e.g. when heating the oven). The hot-air fan could draw in the paper which may damage the heater and fan.
- Do not insert a baking sheet at the bottom of the oven, or cover the base of the oven with aluminium foil, as this would result in heat build up. Roasting and baking times would change, and the enamel would be damaged.
- Never pour water directly into the hot oven. Damage to the enamel could result.
- Dripping juices may leave spots on the oven lining. Always place a baking tray below to prevent this from happening.
- Never stand or sit on the open oven door.
- The oven door must close properly. Keep the door seal surfaces clean.

Introducing: Your new Oven

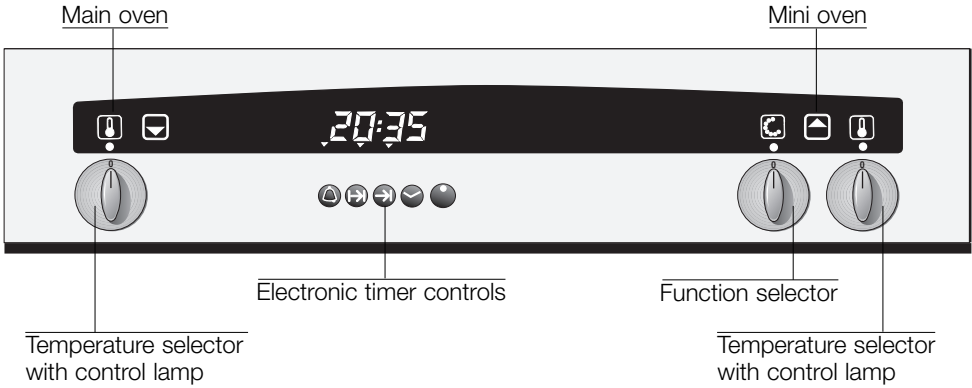



Main oven (circotherm)

Temperature selector



Setting:

-  Oven light
- 50–200** Circotherm temperature in °C
-  Defrosting position



Mini oven

Function selector

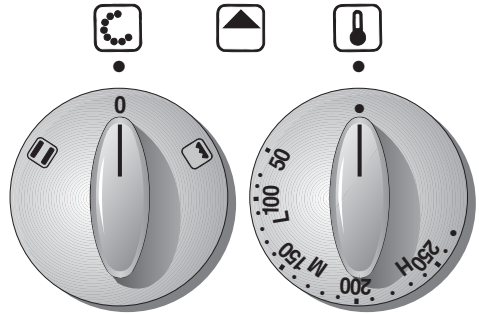
Temperature selector



Setting:

-  Conventional top and bottom heat
-  Radiant grill

Setting:

- 50–250** temperature in °C
- L, M, H** temperature for radiant grill

Introducing: Your new Cooker

Accessories

- Your appliance is supplied with:

3 Wire shelves
1 Roasting/grill pan with grid

- The following accessories can be obtained from the supplier of your oven:

Order no.

Deep roasting pan	Z 1270 X2
Baking tray, aluminium	Z 1330 X0
Baking tray, enamelled	Z 1340 X2
Small grill-set	Z 1240 X2
Supplementary equipment set – Telescopic for Main oven	Z 1750 X0

Note:

- The baking tray or roasting pan may distort while the oven is operating. This is caused by major temperature differences on the utensil. These differences may occur if only one part of the utensil was covered or if deep-frozen food, e. g. pizza, was placed on the utensil.

The distortion will already subside again during baking, roasting or grilling.

Shelf positions

- Your oven features 3 shelf positions. The shelf positions are counted from bottom to top. The numbers are marked in the oven.

Mini oven

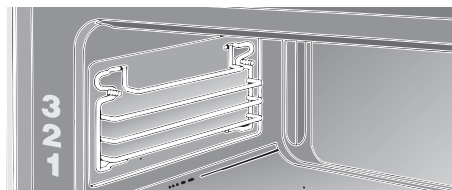

- Your oven features 4 shelf positions. The shelf positions are counted from bottom to top. The numbers are marked in the oven.

⚠ When using **circotherm**, **do not use shelf position »2«**, in order not to block air circulation.

Main oven

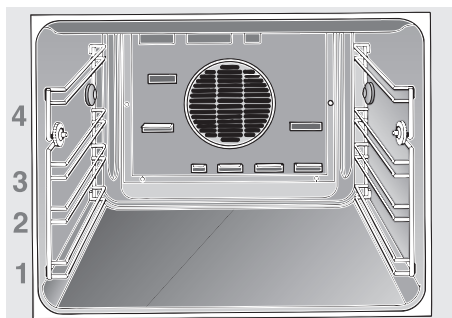

Before Using Your Appliance for the First Time

Time of day

- ❑ Before you use your appliance for the first time, it is necessary to set the current time on the electronic timer.
- ❑ After connecting to the mains, or after a power failure, the display **0:00** will blink.

Setting the time:

Press the  button and set the current time with the rotary knob (e.g. **15:00**).

Note: The time cannot be set if an automatic function is active (see Electronic clock for cancelling automatic function).

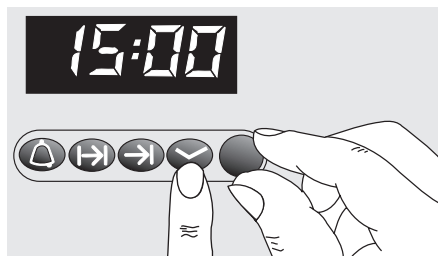

Preliminary cleaning:

1. Clean the appliance exterior with a soft moistened cloth.
2. Clean the oven and the accessories with a hot detergent solution.

Initial burn-in

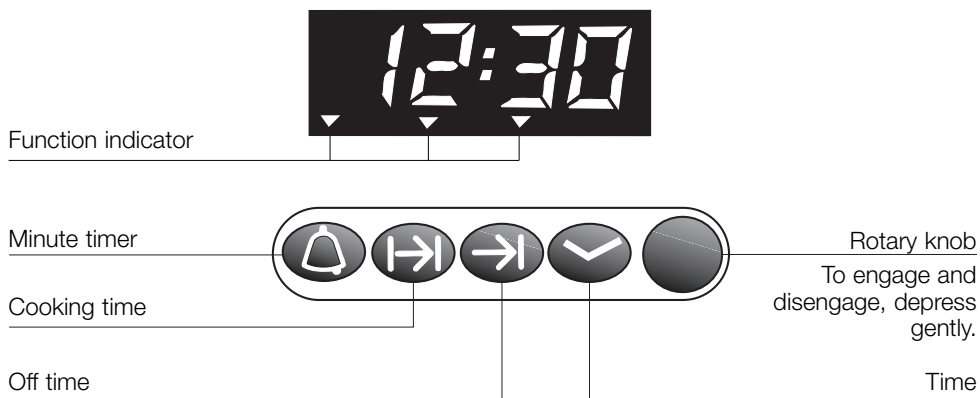

1. Preheat the empty oven for about 30 minutes.
Select heat for the main and mini oven at a setting of 190° C.
During the initial burn-in phase, please open the kitchen windows to dissipate unpleasant odours.

Electronic timer



- The electronic timer can be operated with one hand; after pressing the button, set the time with the rotary knob. Adjustments can be made for as long as the display flashes (4 seconds).
- Setting the time:**
See section "Before using your appliance for the first time".

Minute timer:

1. Press the  button and set the cooking time (e.g. 5 minutes).
When the timer switches on, the remaining time is displayed.
2. If you want to display the current time, press the  button.
3. When the time has elapsed, a signal is emitted and the arrow display flashes.
To stop the signal, press the  button.



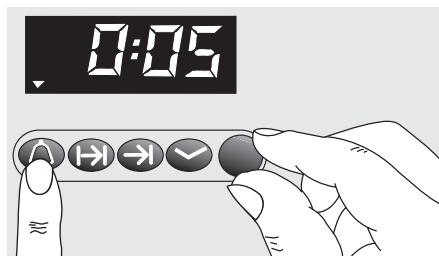

Setting the timer:



Automatic timer for the main oven

- You can switch the oven on and off via the electronic clock.

Automatic switch off:



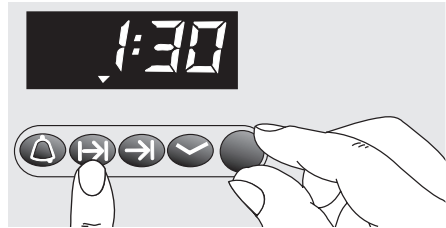

- If you wish to bake or roast food immediately, it is only necessary to set the cooking time.
 1. Set the oven to the required temperature.
 2. Press the  button and set the cooking time with the rotary knob (e.g. 1 hour and 30 minutes).
When the cooking time has been set, the time of day is displayed.
The ▼ displayed above the  button indicates automatic mode.
 3. When the time has elapsed (e.g. 1 hour and 30 minutes), a signal is emitted and the ▼ flashes. The oven is automatically switched off. To stop the signal, press the  button.
 4. Switch the oven off.
 5. To end automatic mode, press the  button again.

Setting the length of cooking time:





Electronic timer

Automatic switch on and switch off:



- ❑ If the food is to be cooked later on, both the cooking time and Off time must be set.
- 1. Set the oven to the required temperature.
When the settings have been made, the time of day is displayed.
- 2. Press the  button and set the cooking time with the rotary knob (e.g. 1 hour and 30 minutes).
- 3. Press the  button and set the Off time with the rotary knob. The ▼ displayed above the  button indicates automatic mode (e.g. 12:30).
- 4. The oven is automatically switched on and off at the preset times (e.g. 11:00 and 12:30).
- 5. When the time has expired, a signal is emitted and the ▼ flashes. To stop the signal, press the  button.
- 6. Switch the oven off.
- 7. To end automatic mode, press the  button.

Checking, correcting and cancelling settings:

1. To check your settings, press the  or  button.
2. If required, correct the settings with the rotary knob.
3. If you want to cancel your settings, turn the set time back to 0:00 and switch the oven off.

Special functions

Masking out the display:

1. Press the  button for 4 seconds.
The display then goes blank and the time continues running in the background.
2. To switch on the display, briefly press the  button.

Dimming the display:

- ❑ Between 22.00 and 6.00 the display is automatically dimmed.

Setting the length of cooking time:



Setting the end of cooking time:

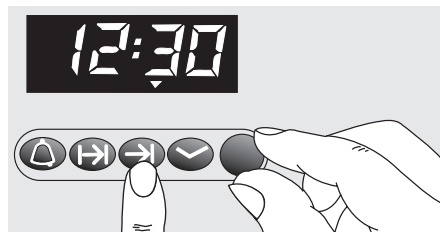

Note:

- ❑ The automatic timer is best used with dishes which require little attention.
- ❑ The minute timer and OFF time can be pre-programmed up to a max. 24 hours.
- ❑ The settings can be displayed at any time by pressing the relevant button.
- ❑ To cancel the preset time:
Press the  button and reset the time to 0:00.

Definition of Oven Features

Mini oven

Conventional cooking _____ 
(top and bottom heat)

The food being cooked is exposed to heat from heating elements located at the top and bottom of the oven cavity.

Cooking is possible on one shelf level only.

Advantages:

- Baking of cake with moist filling, pizza, quiche

Radiant grill _____ 

The food being cooked is exposed to heat from the grill element at the top of the oven cavity.

Advantages:

- particularly suitable for flat, small cuts of meat, i.e., steaks and sausages, fish, vegetables and toast.

Main oven

Circotherm

Advantages:

- low soiling of oven interior
- cooking on up to 3 shelf levels at once is possible
- shorter preheating times
- low oven temperatures
- gentle defrosting 
- bread baking

Circotherm grilling

A system by which foods, that would normally be grilled by direct heat from an element, are cooked using Circotherm. Temperatures between 180 to 190 °C are selected and the food is placed on the wire shelf, roasting on the roasting/grill pan.

Advantages:

- ideal for steaks, sausages, chicken joints, fish, kebabs and chops
- no turning of food is required
- three shelves of 'grilled' food can be prepared at one time
- very convenient

Switching the Oven ON and OFF

Mini oven

Before switching on your oven, you should decide which heating system you wish to use.

Switching the oven ON:

1. Use the function selector to determine the desired system.
 2. Set the temperature control knob to the desired temperature.
- The selected temperature will be controlled automatically.
 - The red oven temperature control lamp illuminates when the oven is first switched on, and extinguishes when the required temperature has been reached.

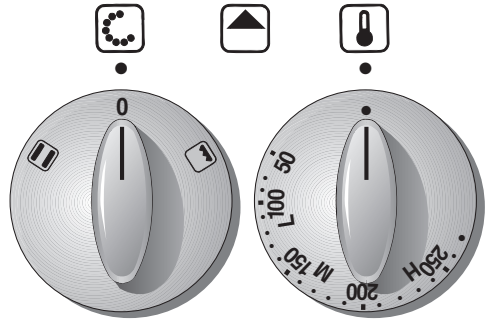

Function selector

Temperature selector

Switching the oven OFF:

To switch the oven OFF, turn both the temperature selector and function selector to the »0« position.

Main oven

1. Set the temperature control knob to the desired temperature.
- The selected temperature will be controlled automatically.
 - The red oven temperature control lamp illuminates when the oven is first switched on, and extinguishes when the required temperature has been reached.

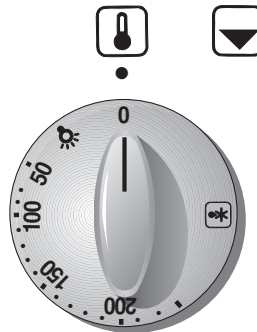

Temperature selector

Using baking tins

- Always place baking tins in the centre of the wire shelf.**
- The wire shelf may be turned upside down to accommodate different size tins.
- If the cake base gets too dark:**
Check the shelf level. Reduce the baking time, and possibly use a lower baking temperature.
- If the cake base stays too light:**
Check the shelf level. Increase the baking time, select a lower temperature, or use a dark metal baking tin.
- You can use baking tins of any material and of any colour, as long as they are oven-proof.
- Do not place baking tins or high cakes too close to the rear oven wall.

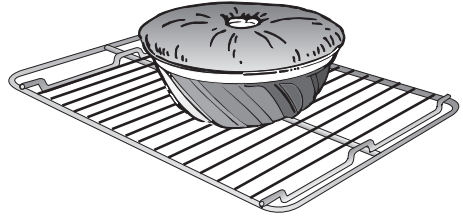

Notes:

- You can influence the degree of browning by changing the temperature setting.
- If a cake collapses after removing it from the oven, use less liquid on your next attempt, consider using a longer baking time, or use a slightly lower temperature setting.

Roasting – Main oven

Roasting with Circotherm

Notes:

- Meat roasted using the Circotherm system will brown on all sides and stay moist without additional fat.
- Choose cuts of meat that weigh 150 grams (5oz) or more.
- Place the shelf on top of the roasting pan.
- Place the meat on the shelf, season if desired.
- Slide the pan and shelf into the oven on the same shelf position.
- No pre-heating is required. Save energy by putting the roast into the cold oven.
- Use a Circotherm temperature of 160 °C.

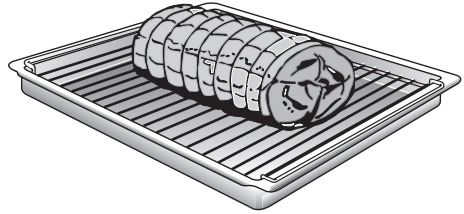

Casseroling or pot-roasting in a covered dish:

- Some meats should be prepared in liquid in a covered casserole. This type of cooking is suitable for less tender cuts of meat.
- Place the casserole on the wire shelf on a suitable shelf position.

Cooking tips:

- Only use ovenproof cookware.
- Extra large turkeys and joints can be placed directly in the roasting pan and not on the wire shelf.
- Cover large turkeys with foil during cooking. Remove foil during the last hour.

Grilling – Main oven

Circotherm grilling

Use this method for small cuts of meat – steaks, chops, sausages, bacon, chicken joints and fish.

- Use the shelf and roasting pan together.
- Season meat as required.
- Place on shelf.
- Do not turn food over – the hot air will circulate around the food cooking all sides.
- Use a temperature of 180–190 °C.

Roasting – Mini oven

Roasting with Conventional heat

- Follow the steps above. With fatty meat 125 – 250 ml (4 – 8floz) of water can be poured into the roasting pan.
- Baste the meat if desired.
- Place in a cold oven to save energy or pre-heat if desired.

Casseroles or pot-roasting in a covered dish:

- Some meats should be prepared in liquid in a covered casserole. This type of cooking is suitable for less tender cuts of meat.
- Place the casserole on the wire shelf at a suitable shelf position.

Cooking tips:

- Only use ovenproof cookware.
- Extra large turkeys and joints can be placed directly in the roasting pan and not on the wire shelf.
- Cover large turkeys with foil during cooking. Remove foil during the last hour.

Grilling – Mini oven

Radiant grilling

Used for small cuts of meat or poultry.

! Exercise CAUTION when grilling.

Always keep children away from the oven when it is in use.

Notes on grilling:

- Always close the oven door when grilling.
- The grilling temperatures are variable.
- Always use the grill and roasting pan together.
- Turn the food after approx. two-thirds of the grilling time has elapsed.
- Lightly brush the wire shelf with oil and baste the food if desired.

- Always place the food to be grilled in the centre of the wire shelf.
- If the heating element switches off automatically, the overheating protection was activated. The element will be reactivated after a short period of time.

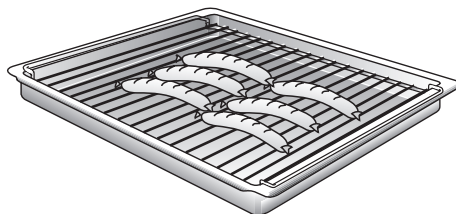

Cooking Tips and Helpful Hints

When cooking with Circotherm:

- Cakes baked in a tin get too dark at the back.
- Cakes remain doughy and collapse when removed from the oven.
- Uneven browning of small cakes or biscuits.
- With very moist foods steam develops and condenses on the oven door and drips onto the floor.

Avoid blocking the air vents at the rear wall of the oven with the cake tins.

Reduce the temperature for deep cakes. Bake for a longer period of time. Test with a skewer before removing.

Avoid placing trays too close to the back wall. Space food on the tray.

Several brief periods of opening the oven door during baking (1 or 2 times, more frequently with longer roasting times) will aid in venting the steam in the oven and reduce condensation.

When cooking conventionally:

- The bottom of a cake baked on a baking tray stays too light.
- The cake gets too dry.
- The inside of the cake remains spongy or doughy, or meat stays raw in the centre.

Ensure that no other pans or trays are in the oven. Lower shelf position. Place tin on wire shelf.

Select a slightly higher oven temperature. Cook for shorter period of time.

Use a slightly lower temperature and cook for a longer time. Reduce the liquid in the cake mixture.

To save energy:

- Preheat only if recommended by the recipe.
- Dark baking tins have a higher degree of heat absorption.

- Residual heat:** In the case of longer baking times, you can switch off the oven 5–10 minutes before the full baking time has elapsed.

Defrosting and cooking using the Circotherm

Important heating system information:

- For defrosting and cooking of frozen foods, use circotherm.
- With all frozen foods, follow the food manufacturers instructions on the package.
- As a rule, **defrosted frozen foods** (especially meats) require less cooking time than fresh products, since freezing has a pre-cooking effect.
- If **frozen meat** is placed in the oven, the defrosting time must be added to the required cooking time.
- Always defrost **frozen poultry** before cooking because the giblets must be removed.
- For cooking **frozen fish**, use the same temperatures as for fresh fish.
- Frozen ready-to-eat meals** in aluminium dishes may be placed into the oven several at a time.
- Frozen vegetables** (i.e., when cooking complete meals) should be cooked in a covered pot together with the roast. Use only approximately half of the liquid specified in the recipe. Use fat only for adding flavour.

Gentle defrosting:

Recommended for delicate pastries only (i.e., whipped-cream gateaus).

- Turn the Circotherm selector switch to the  position. Dependent on size and type of the baked goods, defrost 25 – 45 minutes, take out of the oven and allow to stand 30 – 45 minutes.
- With smaller amounts (pastries), the defrosting time is reduced to 15 – 20 minutes and the subsequent standing time to 10 – 15 minutes.

Standard defrosting of various foods:

Shelf-in levels:

With 1 baking sheet: Slide-in level **3**

With 2 baking sheets: Slide-in levels **1** and **3**

- All stated times** are approximate guidelines that vary with the shape and volume of frozen products.
- Raw frozen products or foods from a freezer** always defrost at 50° C. Higher defrosting temperatures may cause the food to dry out.
- Defrost **frozen meals packed in aluminium foil or closed aluminium containers** at a setting of 130 – 140° C.
- Place frozen meals **packed in plastic bags or plastic containers** in a pot filled with water. Cover the pot and defrost of 130 – 140° C.
Attention: Pot handles must be oven-proof.
- Defrost and warm up **frozen baked goods** at 100 – 140° C. Brush bread, rolls or yeast pastry lightly with egg to make the crust more appealing.
- Defrost **dry frozen yeast cakes** at 160 – 170° C for 20 – 30 minutes.
- Defrost **moist frozen yeast cakes** (with fruit topping) at 160 – 170° C for 30 – 50 minutes after wrapping in aluminium foil to prevent cake from drying out.
- Defrost and toast **frozen toast** (with topping) at 160 – 170° C for about 20 minutes.
- Defrost and bake **frozen pizzas** at 180–190 °C for 15–25 minutes. Place on wire grill covered with greaseproof paper. Please ensure that the greaseproof paper is suitable for use at these temperatures.

Cleaning and Care

Important cleaning basics:

- For cleaning, do not use abrasives, corrosive cleaners, aerosol cleaners or sharp objects.
 - Do not scratch off burnt-on food residues, but soak off them with a damp cloth and washing up liquid.
 - Oven cleaners must not be used on aluminium or plastic parts.
-

Stainless steel front:

- When using commercially available Stainless Steel cleaning agents, avoid cleaning any lettering, as this can become damaged!
 - Do not use any scouring pads or abrasive cleaners.
 - Use commercially available detergents applied with a soft, moistened cloth or a chamois.
-

Enamel and glass:

- Use hot detergent suds for cleaning.
 - Remove the oven door before cleaning the enamel surface.
-

Oven interior:

- Clean the oven after each use, especially after roasting or grilling. Food remnants burn in when the oven is reheated. The baked in remnants are very difficult to remove once burnt in.
- You can reduce the degree of soiling by greater use of the circotherm.
-  Do not clean the warm oven with any of the cleaning products specifically designed for this purpose.

- When baking very moist cake (e.g. rich fruit cake) that could drip over the top of the tin, place on the roasting pan or your own baking sheet.
- When roasting, ensure that the meat juices do not splash on to the base of the oven.
- Clean the oven before soiling becomes too heavy. Wash out the oven cavity with hot detergent suds. Leave the door open until the interior has dried.

Cleaning and Care

Manual cleaning steps:

Note: To make cleaning more convenient, the oven offers you the following options:

Removing the oven door:

1. Fully open the oven door.
2. Move the catch levers on the right and left-hand sides to the fully open position.
3. Placing the door at an upward angle toward you, grasp the door with both hands and lift it out of the hinges toward you.

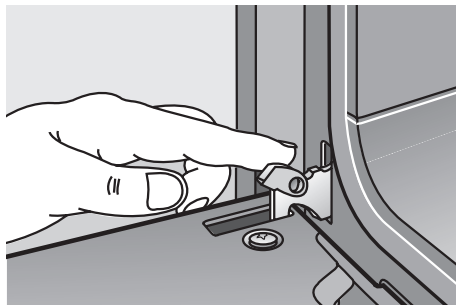

Replacing the oven door:

1. Set both hinges into their respective receptacles on the left and right, and swing the oven door downward.
2. Close the catch levers on the left and right.
3. Close the oven door.

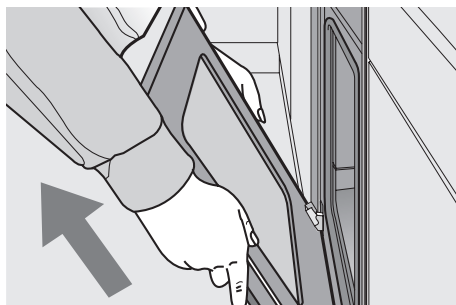

Switch on the oven light

Main oven:

- Turn the temperature selector to the  position.

Mini oven:

- Set the function selector to a random position.

Removing the shelf railings

Main oven:

- On both left and right sides, remove the one milled screws.
- Carefully remove the suspended grids.

Mini oven:

- On both left and right sides, remove two milled screws each.
- Carefully remove the shelf railings.

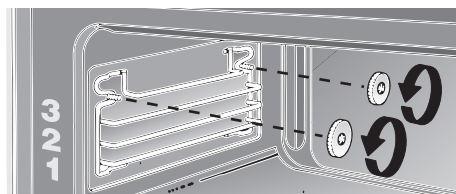
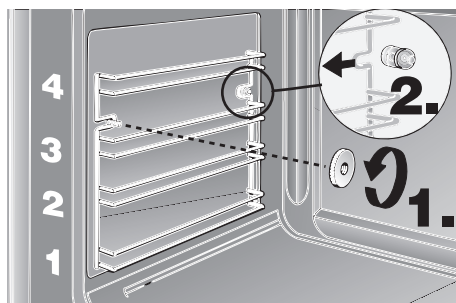

Service and Repair Information

In the event of problems or repairs that you cannot solve yourself, our customer service will be happy to help. Check the customer service directory for an office facility in your area.

You can find this information on the appliance's nameplate. The nameplate is located on the appliance, behind the oven door, on the left bottom edge of the oven.

Caution: Calling customer service because of an operator error can be very costly! In the event of a service request, please have the following information handy:

E-Number	FD
----------	----

Replacing the oven light

Caution: Disconnect the appliance or remove the fuse!

Main oven:

1. To prevent damage, place a tea cloth into the cold oven.
2. Unscrew the lamp cover by turning it anti-clockwise.
3. Replace the lamp.
 - Type: Incandescent bulb E 14, 220–240 V, 40 W, heat-resistant to 300 °C.
 - You may obtain this bulb from our spares department.

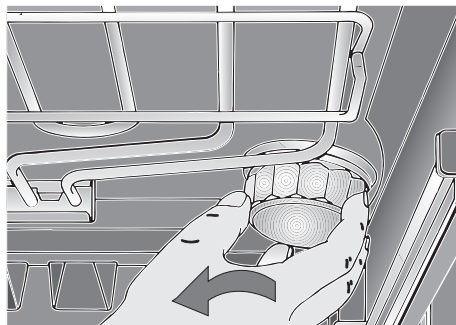

Mini oven:

1. To prevent damage, place a tea cloth into the cold oven.
2. Remove the glass cover by inserting a knife or similar object between the glass and the frame.
3. Replace the lamp.
 - Type: Incandescent bulb E 14, 230–240 V, 25 W, heat-resistant to 300 °C.
 - You may obtain this bulb from our spares department.

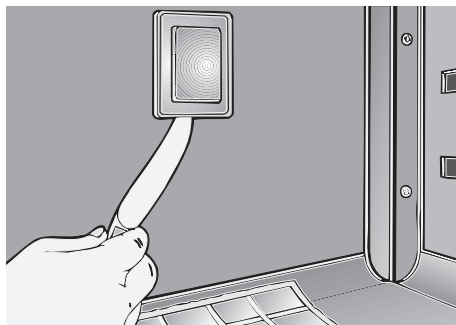

Replacing the oven door seal:

1. Remove the defective oven door seal by simply unhooking it. You may obtain the new oven door seal from our spares department.

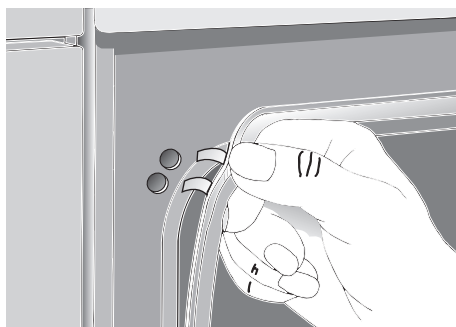

Trouble-shooting Guide

Calling the customer service is not always really necessary. In some cases, you can remedy the situation yourself. The following table may contain some helpful tips.

Important general safety guidelines:

Service or repair work on the electronic components may only be performed by a qualified expert. Without exception, prior to starting such repairs, the appliance must be disconnected from the mains. This may be accomplished by tripping the automatic fuse or by removing the fuse from the fuse box that controls your flat or apartment.

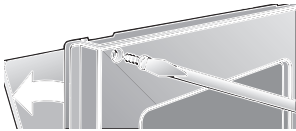
Problem	Possible cause	Remedy
There is a general failure of all electrical functions, i.e., the control lamps have suddenly ceased to function.	Defective fuse.	Check the fuse in the fuse box, and replace if required.
Liquids or thin cake mixes are distributed at a visibly uneven thickness.	The appliance has not been placed or installed plumb-and-level.	Level the appliance using the leveling feet, or check the installation.
... if the oven suddenly stop functioning.	The electronic timer is set to an automatic timing cycle.	Set electronic timer to operation without automatic timer: 1. Reset ON time (→) to 0:00 . 2. Press the (→) button.
... if the oven suddenly stops functioning and the electronic timer flashes 0:00 ?	The power supply was briefly interrupted.	Reset the time of day.
The oven door window pane fogs up.	This is a normal condition. It is caused by the occurrence of temperature differences.	Heat the oven at 100 °C for about 5 minutes.
A considerable amount of water condensation occurs in the oven.	This condition is normal with moist cakes or with very large roasts.	During baking or roasting, open the oven briefly several times; wipe up condensation after use.
After prolonged use, the oven window panes are soiled from the inside.	This kind of soiling is normal. 	Remove the oven door , and put aside with the handle facing upward. For cleaning, remove the two screws at the door handle moulding with a screwdriver. Caution: During reassembly, install both the door handle and the door seal in their original positions.

Assembly Instructions

For the installer and kitchen expert!

Important installation notes:

- Properly dispose of **packaging materials**.
- Do not use **oven door handle** for transporting or handling the unit during installation.
- WARNING:** Connection and first start of the appliance may only be performed by an authorised specialist.
- Connection must be made using an H05VV-F mains connection cable.
- Rated consumption, rated voltage and type no. of the appliance:**
See appliance nameplate behind the oven door to the left beneath the side edge of the oven.
- The unit's nameplate is located at on the right sidewall of the unit.**
- Electrical safety** of the appliance can be ensured only if the equipment earth in the building installation has been installed according to regulations.
- On the installation side a isolating device shall be provided.
Any switch with a contact gap exceeding 3 mm may be considered a separating device.
Other examples are LS switches, fuses and contactors.
- In the case of repairs** interrupt all power connections to the unit.
- Connection diagram**

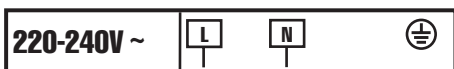

Kitchen furniture

Oven housing units from virtually all lines of kitchen furniture are suitable for installing the built-in oven. However, the veneers or plastic laminates on the housing unit must be applied with heat-resistant glue (90 °C). If plastic laminate or glue are not sufficiently heat-resistant, warping, bubbling or detachment of the finish may result.

Assembly Instructions

Installation of the built-in oven

- ❑ To burn-in the insulation, heat up the oven prior to installing the unit.
- ❑ Push the built-in oven into the housing unit and align the unit until it is in a **level position**.
- ❑ Open the oven door and, using one screw on each side, fasten the built-in oven to the side strips of the housing unit (see illustration).
The two screws (supplied with the built-in oven) must be started slightly outward.
- ❑ Verify that the built-in oven is positioned securely and in a **level position**, and that the required installation dimensions have been maintained.
- ❑ The properly installed appliance must be covered on all sides in such a fashion that not even components with rough insulation are exposed to the touch. The cover must be removable with tools only.

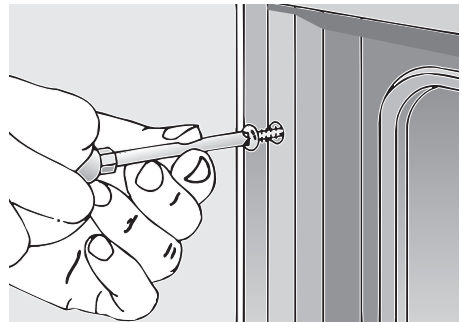
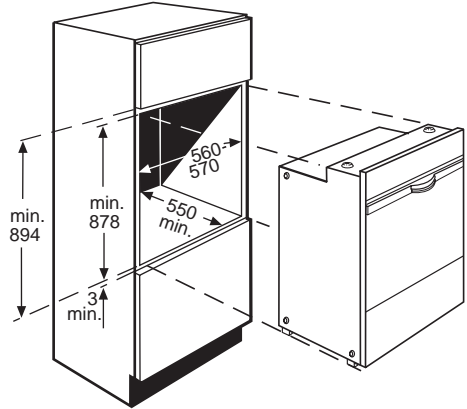

NEFF (UK) Ltd.
Grand Union House,
Old Wolverton Road,
Old Wolverton
Milton Keynes, MK12 5PT
Tel: 01908 328300
Fax: 01908 328399

5750 202 045
Printed in Germany 1203 Es.