



Dear customer,

congratulations on the purchase of your new Neff oven. We would like to thank you for your confidence in us and we hope that you will have many years of enjoyment and cooking pleasure with your new appliance.

To be able to take full advantage of all the technical features of your cooker, please read these instructions for use.

The detailed table of contents will guide you quickly to all the important information:

- You will be informed of important safety information.
- You will then be familiarised with the individual parts of your new oven.
- Step by step guide on how to select particular settings.
- The tables list the settings and shelf positions for a selection of typical recipes, all of which are tested in our cookery centre.
- In the unlikely event of a malfunction, this is where you will find information on how to rectify minor faults yourself.

Have fun cooking.

Instructions for use

U17M42.0GB

en

9000 272 828

Table of contents

Safety information	5
Before installation	5
Information for your safety	5
Causes of damage	7
Energy and environment tips	8
Saving energy	8
Environmentally friendly disposal	8
Your new appliance	9
Control panel	9
Operating modes	10
Shelf positions	11
Accessories	12
Before using the appliance for the first time ...	13
Setting the time	14
Cleaning the appliance	14
Using the appliance	15
Switching on the appliance	15
Switching off the appliance	16
Electronic clock	16
Clock display	17
Timer	18
Cooking time	18
End of operation	19
Preselection mode	20
Setting the time	21
Checking, correcting or deleting settings	21

Table of contents

Baking	22
Baking on one level	23
Baking on two or more levels	23
Baking table	24
Baking table for pre-prepared products	26
Tips and tricks	28
Roasting and braising	29
Roasting	29
Braising	30
Tables for roasting and braising	31
Tips and tricks	33
Grilling	33
Wire rack position	34
Grilling table	35
Defrosting	36
Defrosting with Circotherm hot air	36
Defrost setting	37
Yoghurt	38
Cleaning and care	39
Cleaning the appliance exterior	40
Cleaning the cooking compartment	40
Self-cleaning surface	42
Removing and fitting the appliance door	42
Cleaning the door panels	44
Cleaning hook-in racks	46

Table of contents

Faults and repairs	48
Replacing the cooking compartment bulb	49
Changing the door seal	50
After-sales service	51
Test dishes	52

Safety information

Read this instruction manual carefully. Please keep the instruction and installation manuals in a safe place. Please pass on these manuals to the new owner if you sell the appliance.

Before installation

Transport damage

Check the appliance for damage after unpacking it. Do not connect the appliance if it has been damaged in transport.

Electrical connection

Only allow a licensed professional to connect the appliance. Damage caused by incorrect connection is not covered under warranty.

Information for your safety

This appliance is intended for domestic use only. This appliance must only be used for food preparation.

Adults and children must not operate the appliance without supervision,

- if they are physically or mentally incapable of doing so or
- if they lack the knowledge and experience.

Never let children play with the appliance.

Hot cooking compartment

There is a risk of burns.

Never touch the interior surfaces of the cooking compartment or the heating elements. Open the appliance door carefully. Hot steam may escape. Small children must be kept at a safe distance from the appliance.

There is a risk of fire.
Never store combustible items in the cooking compartment.
Never open the appliance door if there is smoke inside. Switch off the appliance. Pull out the mains plug or switch off the appliance by the fuse in the fuse box.

There is a risk of short-circuiting.
Never trap connecting cables of electrical appliances in the hot appliance door. The cable insulation could melt.

There is a risk of scalding
Never pour water into the hot cooking compartment. This will cause hot steam.

There is a risk of burns.
Never prepare food containing large quantities of drinks with a high alcohol content. Alcoholic vapours can catch fire in the cooking compartment. Only use small quantities of drinks with a high alcohol content and open the appliance door carefully.

Hot accessories and ovenware

There is a risk of burns.
Never remove ovenware and accessories from the cooking compartment without an oven cloth or oven gloves.

Incorrect repairs

There is a risk of electric shock.
Incorrect repairs are dangerous. Repairs may only be carried out by one of our experienced after-sales engineers.
If the appliance is defective, pull out the mains plug or switch off the appliance by the fuse in the fuse box.
Call the after-sales service.

Causes of damage

Accessories, foil, greaseproof paper or ovenware on the cooking compartment floor

Do not place accessories on the cooking compartment floor. Do not cover the cooking compartment floor with any sort of foil or greaseproof paper. Do not place ovenware on the cooking compartment floor if a temperature of over 50 °C is set.

This will cause heat accumulation. The baking and roasting times will no longer be correct and the enamel will be damaged.

Water in the hot cooking compartment

Never pour water into the hot cooking compartment. This will cause steam. The temperature change can cause damage to the enamel.

Moist food

Do not store moist food in the closed cooking compartment for long periods. This will damage the enamel.

Fruit juice

When baking very moist fruit flan, do not put too much on the baking tray. Fruit juice dripping from the baking tray leaves stains that cannot be removed. If possible, use the deeper universal pan.

Cooling with the oven door open

Only leave the cooking compartment to cool with the door closed. Even if you only leave the oven door open slightly, the fronts of adjacent units may become damaged over time.

Very dirty oven seal

If the oven seal is very dirty, the oven door will no longer close properly when the oven is in use. The fronts of adjacent units could be damaged. Always keep the oven seal clean.

Oven door as a seat or storage space

Do not stand or sit on the open oven door. Do not place ovenware or accessories on the oven door.

Transporting the appliance

Do not carry or hold the appliance by the door handle. The door handle cannot support the weight of the appliance and could break.

Energy and environment tips

Here you can find tips on how to save energy when baking and roasting and how to dispose of your appliance properly.

Saving energy

Only preheat the oven if this is specified in the recipe or in the operating instruction tables.

Use dark, black lacquered or enamelled baking tins. They absorb the heat particularly well.

Open the appliance door as little as possible during cooking, baking or roasting.

It is best to bake several cakes one after the other. The cooking compartment is still warm. This may reduce the baking time for the second cake.

For longer cooking times, you can switch the oven off 10 minutes before the end of the cooking time and use the residual heat to finish cooking.

Environmentally-friendly disposal



Dispose of packaging in an environmentally-friendly manner.

This appliance is labelled in accordance with European Directive 2002/96/EC on Waste Electrical and Electronic Equipment - WEEE.

The directive gives a framework for the collection and recycling of old appliances, which is valid across the EU.

Your new appliance

This section provides information on

- the control panel
- the operating modes
- the shelf positions
- the accessories

Control panel

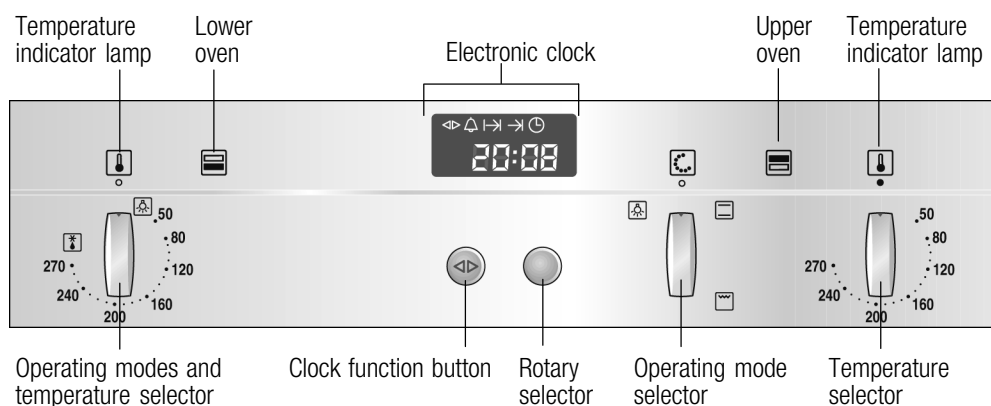

Lower oven

Control element	Use
Operating modes and temperature selector	Switches on the interior lighting, selects the temperature for CircoTherm® or the Defrost operating mode
Clock function button	Selects the required clock function (see section: Electronic clock)
Rotary selector	Makes settings within a clock function (see section: Electronic clock)

Upper oven

Control element	Use
Operating mode selector	Selects the desired operating mode
Temperature selector	Sets the desired temperature



Pop-out control knobs

The rotary, temperature and operating mode selectors can all be popped out. To pop the knob in and out, push the appropriate operating knob.



Operating modes

Here is an overview of the operating modes of your appliance.

Lower oven

Operating mode	Application
 Interior lighting	Provides assistance when maintaining and cleaning the cooking compartment
50 - 270 °C CircoTherm®	For baking and roasting on one or more levels
 Defrost	For gentle defrosting of pieces of meat, bread and delicate pastries (e.g. cream gateau)

Upper oven

Operating mode	Application
 Top/bottom heat	Especially suitable for cakes with moist toppings (e.g. cheesecake)
 Full-surface grill	For large amounts of flat, small items for grilling (e.g. steaks, sausages)
 Interior lighting	Provides assistance when maintaining and cleaning the cooking compartment

Shelf positions

The shelf positions in the cooking compartment are counted from the bottom up.

Note:

When baking and roasting with Circotherm®, do not use shelf position 2. Air circulation is adversely affected and the results of baking and roasting are impaired.

Bottom oven

The cooking compartment in the main oven has three shelf positions.

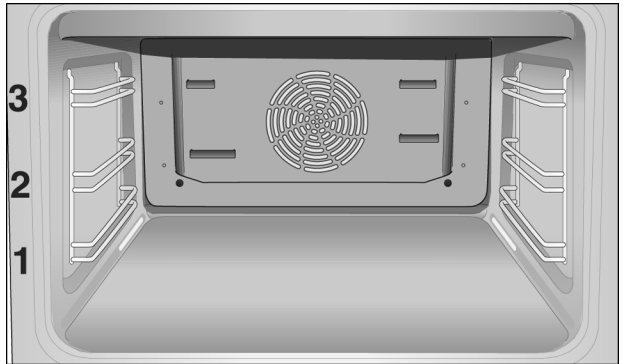

Top oven

The cooking compartment of the top oven has two shelf positions.

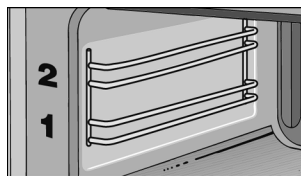

Accessories

Your appliance is equipped with the following accessories:

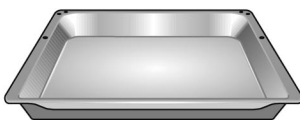

Universal pan, enamelled
for baking, roasting and grilling or for collecting drops of liquid



Stepped wire rack, close meshed
for baking, roasting and grilling, for placing in the universal pan



2 x wire rack, flat, with tilt protection
for baking

Insert the flat wire racks in such a way that the rear upstand (to prevent items sliding off the back of the shelf) is at the back and is pointing upwards (see illustration below). Otherwise, the tilt protection feature will not work properly.

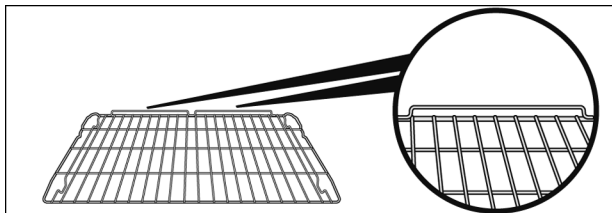

You can obtain further accessories from specialist retailers:

Accessories	Order no.
Grill set	Z1240X2
Glass pan	Z1262X0
Enamelled roasting pan	Z1272X0
Aluminium baking tray	Z1332X0

Accessories	Order no.
Enamelled baking tray	Z1342X0
Non-stick baking tray	Z1343X0
Baking and roasting shelf, close meshed	Z1453X0
Two-piece enamelled roasting tray	Z1512X0
CLOU 1x telescopic railing retrofit kit	Z1700X0
CLOU 3x telescopic railings retrofit kit	Z1762X0
Tilt protection retrofit kit, pull-out stop	Z9110X0
Enamelled universal roasting dish	Z9930X0

Note:

The baking tray or universal pan may become distorted when the oven is operating. This is caused by the considerable temperature differences on the accessories. This may happen when only a part of the accessory is covered with food or when frozen items such as pizza have been placed on the accessory.

Before using the appliance for the first time

This section contains information on

- how to set the time on your appliance after the power is connected
- how to clean your appliance before using it for the first time

Setting the time

0:00 flashes in the clock display.



1. Press the clock function setting button.
The $\triangleleft\triangleright$ and \checkmark symbols are lit.
12:00 flashes in the clock display.
2. Set the current time using the rotary selector.
Your setting is automatically adopted after 3 seconds.

Changing the time

To subsequently change the time, press the clock function button repeatedly until the $\triangleleft\triangleright$ and \checkmark symbols are lit. Set the current time using the rotary selector.

Cleaning the appliance

Clean your appliance before using it for the first time.

1. Remove accessories and residual packaging from both cooking compartments.
2. Clean the accessories and cooking compartments with hot soapy water (see section: Cleaning and care).
3. Heat the upper oven at 270 °C using Full-surface grill and the lower oven at 240 °C using CircoTherm® for 30 minutes.
4. Once the cooking compartments have cooled, wipe them out with hot soapy water.
5. Clean the outside of the appliance with a soft damp cloth and soapy water.

Using the appliance

This section contains information on

- how to switch your appliance on and off
- how to select an operating mode and temperature

Switching on the appliance

Lower oven

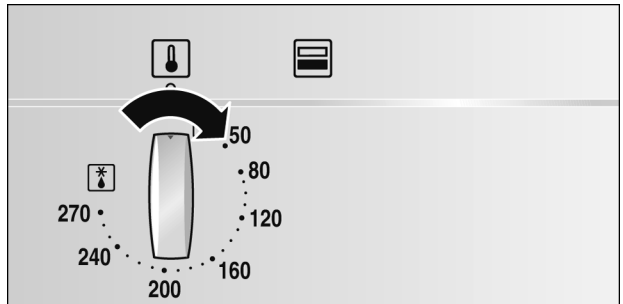

Interior lighting

Turn the operating mode and temperature selector to the  position in order to switch on the interior lighting.

CircoTherm®

Turn the operating mode and temperature selector to the required temperature in order to switch on CircoTherm®.

Defrost

Turn the operating mode and temperature selector to the  position in order to switch on the defrost setting.

Upper oven

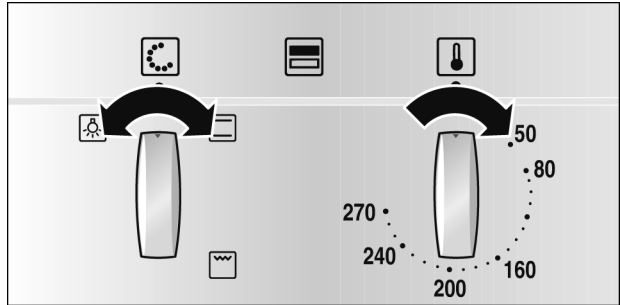

1. Turn the operating mode selector until the desired operating mode is selected.
2. Turn the temperature selector until the desired temperature is selected.

The  indicator lamp is illuminated while the appliance is heating up and during any subsequent heating.

Switching off the appliance

Reset the operating mode and temperature selectors to the 0 position.

After the appliance is switched off, the cooling fan may continue to run.

Electronic clock

This section contains information on

- how to set the timer
- how to switch your appliance off automatically (cooking time and end of operation)
- how to switch your appliance on and off automatically (preselection mode)
- how to set the time

Clock display



Clock function	Use
Timer	You can use the timer as an egg timer or a kitchen timer. The appliance does not switch on or off automatically.
Cooking time	Lower oven: The oven switches off automatically after a cooking time setting has elapsed (e.g. 1:30 hours).
End of operation	Lower oven: The oven switches off automatically at a set time (e.g. 12:30).
Preselection mode	Lower oven: The oven switches on and off automatically. Cooking time and end of operation are combined.
Clock	Setting the clock

Notes:

- Between **22:00** and **5:59**, the clock display is darkened if you do not alter any settings during this time or if no clock function is activated.
- For the timer, cooking time, end of operation and preselection mode clock functions, a signal sounds when the cooking time has elapsed and the or symbol flashes. To cancel the audible signal before it ends, press the clock function button.

Switching the clock display on and off

1. Press and hold the clock function button for 6 seconds.

The clock display switches off. If a clock function is active, the associated symbol remains lit.

2. Press the clock function button briefly.

The clock display switches on.

Timer



1. Press the clock function button repeatedly until the $\leftarrow \rightarrow$ and \triangle symbols light up.
2. Use the rotary selector to set the cooking time (e.g. **5:00** minutes).

The setting is accepted automatically. Then the clock is displayed again and the timer starts counting down.

Cooking time

Automatic switch-off after a set cooking time.



1. Set the operating mode and temperature for the lower oven.

The lower oven starts heating.

2. Press the clock function button repeatedly until the ◀▶ and →| symbols light up.

3. Use the rotary selector to set the cooking time (e.g. 1:30 hours).

The setting is accepted automatically. Then the clock is displayed again and the set cooking time starts counting down.

Once the cooking time has elapsed, the lower oven switches off automatically.

4. Turn the operating mode and temperature selectors back to the 0 position.
5. Press the clock function button to quit the clock function.

End of operation

Automatic switch-off at a set time.



1. Set the operating mode and temperature for the lower oven.
The lower oven starts heating.
2. Press the clock function button repeatedly until the ◀▶ and →| symbols light up.
3. Use the rotary selector to set the end of operation (e.g. 12:30).
The setting is accepted automatically. The clock is then displayed again.

The lower oven switches off automatically at the time set for the end of operation.

4. Turn the operating mode and temperature selectors back to the 0 position.
5. Press the clock function button to quit the clock function.

Preselection mode

The lower oven switches on automatically and switches off at the time preselected for the end of operation. To set this function, combine the clock functions cooking time and end of operation.

Bear in mind that food which spoils easily must not stay in the cooking compartment for too long.

1. Set the operating mode and temperature for the lower oven.

The lower oven starts heating.

2. Press the clock function button repeatedly until the ◀▶ and I→ symbols light up.

3. Use the rotary selector to set the cooking time (e.g. **1:30** hours).

The setting is accepted automatically.

4. Press the clock function button repeatedly until the ◀▶ and →I symbols light up.

5. Use the rotary selector to set the time for the end of operation (e.g. **12:30**).

The lower oven switches off and waits until the correct time to switch on (in the example at **11:00**).



The lower oven switches off automatically at the time set for the end of operation (**12:30**). A signal sounds and the →I symbol flashes.

6. Turn the operating mode and temperature selectors back to the 0 position.
7. Press the clock function button to quit preselection mode.

Setting the time

You can only change the clock, when no other clock functions are active.



1. Press the clock function button repeatedly until the  and  symbols light up.
2. Set the time using the rotary selector.
The setting is accepted automatically.

Checking, correcting or deleting settings

1. To check your settings, press the clock function button repeatedly until the corresponding symbol lights up.
2. If necessary, you can correct your settings using the rotary selector.
3. If you want to delete your settings, turn the rotary selector to the left, back to the original value.

Baking

In this section, you will find information on

- Baking on one level
- Baking on two or more levels
- The baking table
- The baking table for pre-prepared products
- Tips and tricks for baking

Note:

When baking with  CircoTherm®, do not use shelf height 2. Air circulation is adversely affected and the results of baking are impaired.

We recommend that you use dark baking tins made from metal.

Light-coloured baking tins and glass dishes lengthen the baking time and the cake will not brown so evenly.

Always slide the universal pan in carefully as far as it will go and make sure that the sloping edge is facing the appliance door.

Slide a wire rack in so that the rear upstand to prevent items sliding off the back of the shelf is at the rear. This prevents baking tins slipping off the back.

Baking on one level

If you are baking on one level with  CircoTherm®, always place a round baking tin in the centre (figure A) and a cake tin diagonally (figure B) on the stepped wire rack.

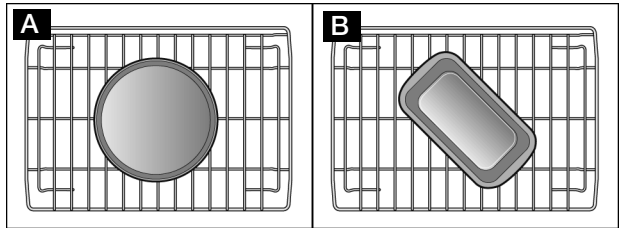

If you are baking on one level with  CircoTherm®, always place two round baking tins diagonally on the on the stepped wire rack (figure C).

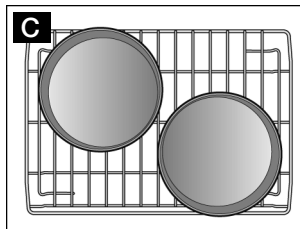

Baking on two or more levels

When baking on several levels, only use the  CircoTherm® operating mode.

Bear in mind that your items may brown at different rates on the different levels. The items on the top level will brown most quickly and can be taken out earlier.

Two baking tins on two levels

When baking with two round baking tins or two trays, slide the stepped wire rack in at shelf position 1 and the straight wire rack in at shelf position 3.

Position the lower baking tin on the left (figure A) and the upper baking tin on the right (figure B) on the different wire racks.

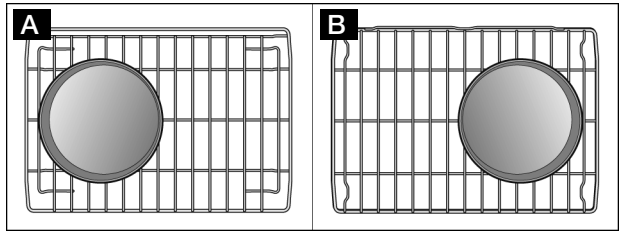

Four baking tins on two levels

When baking with four round baking tins, slide the stepped wire rack in at shelf position 1 and the straight wire rack in at shelf position 3.

Position the lower baking tins diagonally as shown in figure C and the upper baking tins diagonally as shown in figure D on the different wire racks.

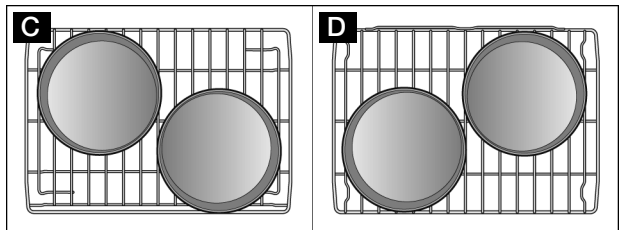

Baking table

The values in the table are average values and apply to dark baking tins. The values may vary depending on the type and amount of dough/mixture and on the baking tin.

We recommend that you set the lower of the specified temperatures the first time. This will generally allow more even browning.











If you are baking with your own recipe, use similar recipes in the table as a guide.

Observe the notes in the table about preheating.

Meal	Oven	Setting	Level	Temperature in °C	Time in minutes
Victoria sponge cake					
■ 1 level			1	160 - 170*	25 - 30
■ 1 level			1	160 - 170*	25 - 30
■ 2 levels			1 + 3	160 - 170*	25 - 30
Scones					
■ 1 level			1	180 - 200*	8 - 10
■ 1 level			1	200 - 210*	10 - 12
■ 2 levels			1 + 3	180 - 200*	8 - 12
Small cakes					
■ 1 level			1	160 - 170*	20 - 25
■ 1 level			1	160 - 170*	25 - 30
■ 2 levels			1 + 3	150 - 160*	20 - 30
Light fruit cake			1	140 - 150*	80 - 100
Rich fruit cake			1	140 - 150*	210 - 240
Jamtartes					
■ 1 level			1	180 - 190*	15 - 20
■ 1 level			1	190 - 210*	15 - 25
■ 2 levels			1 + 3	180 - 190*	20 - 25
Swiss roll			1	180 - 190*	10 - 15
			1	190 - 200*	10 - 15
Tart					
■ 1 level			1	160 - 170*	50 - 60
■ 2 levels			1 + 3	160 - 170*	55 - 65
Pies					
■ 1 level			1	170 - 180*	70 - 80
■ 2 levels			1 + 3	170 - 180*	65 - 75
Biscuits					
■ 1 level			1	160 - 170*	15 - 20
■ 1 level			2	170 - 180*	15 - 20
■ 2 levels			1 + 3	160 - 170*	15 - 20
Baiser			1	80*	100 - 130
			1	80*	110 - 140
Pavlova			1	80 - 90**	80 - 100
Fruit crumble			1	160 - 170*	40 - 50
Yorkshire pudding					
■ 1 level			1	200 - 220*	10 - 15
■ 2 levels			1 + 3	200 - 220*	15 - 20
Vol au vents			1	190 - 200*	20 - 30
Quiche			1	170 - 180*	45 - 55

* Preheat oven

** Preheat the oven to 130 °C

Meal	Oven	Setting	Level	Temperature in °C	Time in minutes
(White) bread					
■ 1 level			1	210 - 220*	20 - 30
Homemade pizza					
■ 1 level			1	210 - 220*	20 - 30
■ 2 levels			1 + 3	180 - 190*	35 - 45
Jacket potatoes					
■ 1 level			1	160 - 170	60 - 70
■ 2 levels			1 + 3	160 - 170	65 - 75
* Preheat oven					
** Preheat the oven to 130 °C					

Baking table for pre-prepared products

Please note the following points for pre-prepared products:



































- Use the universal pan
- Only use greaseproof paper that is suitable for the selected temperature
- Spread chips out in a single layer
- Turn frozen potato products half way through the baking time
- Only season frozen potato products after they have finished baking
- Leave a little space between bread rolls when crisping them up. Do not place too many in the universal pan
- Cover lasagne with plenty of cheese, so that the top browns evenly
- Do not use frozen products with freezer burn
- Do not use frozen products that are heavily frosted
- Follow the manufacturer's instructions

The values in the table are average values and apply to the universal pan.

We recommend that you set the lower of the specified temperatures the first time. This will generally allow more even browning.

When baking on several levels, only use the  CircoTherm® operating mode.

Observe the notes in the table about preheating.

Meal	Oven	Setting	Level	Temperature in °C	Time in minutes
Frozen pizza					
■ 1 level			1	180 - 200*	15 - 25
■ 1 level			1	180 - 200*	10 - 20
Chilled pizza					
■ 1 level			1	200 - 210*	10 - 15
Part-baked white bread					
■ 1 level			1	180 - 190*	10 - 20
■ 1 level			1	190 - 200*	5 - 15
French fries			1	180 - 200*	25 - 30
French fries			1	190 - 200*	25 - 30
Potato wedges			1	180 - 190*	20 - 25
Potato wedges			1	190 - 200*	15 - 20
Croquettes			1	180 - 190*	25 - 30
Croquettes			1	190 - 200*	20 - 25
Fish fingers			1	180 - 200*	15 - 20
Fish fingers			1	190 - 200*	10 - 15
Lasagne, frozen (400 g)			1	180 - 190*	35 - 40
Lasagne, frozen (1200 g)			1	180 - 190*	40 - 45
Lasagne, chilled (400 g)			1	170 - 180*	35 - 40
Lasagne, chilled (1200 g)			1	170 - 180*	40 - 45

* Preheat oven

Tips and tricks

The cake is too light in colour

Check the shelf height.

Check whether you have used the bakeware that we have recommended.

Place your tin on the wire rack and not on the baking tray.

If the shelf height and the bakeware are correct, then you should either extend the baking time or increase the temperature.

The cake is too dark

Check the shelf height.

If the shelf height is correct, you should either shorten the baking time or reduce the temperature.

The cake is unevenly browned in the baking tin

Check the shelf height.

Check the temperature.

Make sure that your baking tin is not placed directly in front of the air outlets in the rear wall of the cooking compartment.

Check that the baking tin is correctly positioned on the wire rack.

The cake is too dry

Set a slightly higher temperature and a slightly shorter baking time.

The cake is too moist in the centre

Set a slightly lower temperature.

Note: you cannot decrease the baking time by setting a higher temperature (the outside will be cooked, but the inside will remain uncooked).

Select a longer baking time and allow the cake mixture to prove for longer.

Add less liquid to the mixture.

The cake collapses when you take it out of the oven

Use less liquid for the mixture.

Set a longer baking time or a slightly lower temperature.

The specified baking time is not correct

For small items, check the amount on the baking tray. The items must not be touching each other.

Frozen products are not browned evenly after baking

Check whether the frozen product is unevenly browned before baking. This uneven browning will remain after the baking time.

Several cakes on one level are unevenly browned

Check the position of the baking dishes on the wire rack.

Frozen products are not browned, not crispy or the specified time is not correct

Remove ice from frozen products before baking. Do not use frozen products that are heavily frosted.

Saving energy

Only preheat the appliance when it is specified in the baking table that you should do so.

Use dark baking tins as these absorb the heat better.

Make use of the residual heat with longer baking times and switch the oven off 5 - 10 minutes before the end of the baking time.

Roasting and braising

In this section, you will find information on

- Roasting
- Braising
- Tables for roasting and braising
- Tips and tricks



There is a risk of injury if you use roasting dishes that are not heat-resistant. Only use roasting dishes that are marked as being suitable for use in the oven.

Note:

When roasting with  CircoTherm®, do not use shelf height 2. The air circulation would be impaired and this will have a negative effect on your roast.

Roasting

Roasting in the universal pan

For roasting, a roasting dish without a lid is used.

Juices escape from the roasting meat and are collected in the universal pan. You can use these juices as the basis for a tasty gravy.

Deglaze the pan of the juices with hot water, stock, wine or similar, bring it to the boil, thicken with cornflour, season and pass through a sieve if necessary.

You can also cook side dishes (e.g. vegetables) at the same time as roasting meat in the universal pan.

Note:

For smaller joints, you can use a smaller roasting dish instead of the universal pan. Place this directly on the wire rack.

Roasting in the universal pan with stepped wire rack

Place the stepped wire rack on the universal pan and slide them in together at the same shelf height.

For fatty meat and poultry, add $\frac{1}{8}$ to $\frac{1}{4}$ litre of water to the universal pan, depending on the size and type of the joint.

While the meat is roasting, the liquid in the roasting dish will evaporate. Pour in more hot water if required.

Roasting in the universal pan with roasting sheet

The roasting sheet reduces dirt in the cooking compartment. Place the roasting sheet in the universal pan and slide them in together at the same shelf height.

Dripping fat and meat juices are caught in the universal pan.

Braising

For braising, a roasting dish with a lid is used. Ensure that the roasting dish and lid are designed for one another and fit closely.

First, sear the meat if required.

Add the meat, vegetables and liquid to the roasting dish in the proportion 1:1:1 and place it with the lid closed on the wire rack on shelf position 1.

While the meat is braising, the liquid in the roasting dish will evaporate. Pour in more liquid if required.

Tables for roasting and braising

Poultry

The values in the tables are only average values.

The information in the tables applies to unstuffed poultry. Turn the poultry after half of the cooking time.

Lean meat

Coat lean meat with fat or oil as required and cover it with strips of bacon.

Cooking time and temperature

The cooking time and temperature depend on the size, height, type and quality of the food and the roasting dish.

In general, the larger the joint, the lower the temperature and the longer the roasting time.





You should set the lower of the specified temperatures the first time. This will generally allow more even browning.





























The values for cooking time apply to 0.5 - 2 kg of food. For greater weights, reduce the temperature and increase the cooking time. For multiple pieces, apply the cooking time for the weight of the heaviest piece.







Standing time

At the end of the cooking time, switch the oven off and leave the roast to stand for approximately 10 minutes in the cooking compartment with the door closed. The recommended standing time is not included in the cooking times specified.

The information in the tables apply to food placed in a cold oven and for meat taken directly from the refrigerator.

Meal	Oven	Setting	Level	Temperature in °C	Time in minutes (per 500 g)
Beef					
Slow roast joint			1	140	40 + 40
Top side / top rump			1	160	30 + 25

Meal	Oven	Setting	Level	Temperature in °C	Time in minutes (per 500 g)
Lamb					
Leg			1	170	30 + 25
Shoulder (bone-in)			1	170	25 + 20
Shoulder (boned and rolled)			1	170	30 + 25
Rack of lamb			1	180	25 + 25
Pork					
Roast joint			1	180	35 + 35
Loin joint			1	180	30 + 30
Belly			1	160	30 + 25
Gammon					
Joint			1	160	30 + 30
Chicken					
Whole chicken			1	170 - 180	20 + 25
Portion (boned)			1	190	20 + 25
Quarter			1	190	20 + 25
Duck			1	180	20 + 20
Turkey					
Drumstick			1	180	20 + 20
Crown			1	160	25 + 20

Casseroles	Oven	Setting	Level	Temperature in °C	Time in minutes (per 500 g)
Diced meat (beef, pork, lamb, chicken)			1	140	40 + 80
Braising steak			1	140	45 + 80
Chicken pieces (boned)			1	140	50 + 70

Tips and tricks

Crust too thick and/or roast too dry	Reduce the temperature or shorten the roasting time. Check the shelf height.
Crust too thin	Increase the temperature or switch on the grill briefly at the end of the roasting time.
The meat is not cooked right through	Remove any accessories that are not required from the cooking compartment. Increase the roasting time. Check the core temperature of the joint using a meat thermometer.
Steam in the cooking compartment is condensing on the appliance door	The steam dries during the course of the cooking. If there is an excessive volume of steam, you can carefully open the door briefly to dissipate the steam more quickly.
The meat is burned slightly during braising	Add the meat, vegetables and liquid to the roasting dish in the proportion 1:1:1. The roasting dish and lid must be designed for one another and fit closely. Reduce the temperature.

Grilling

In this section, you will find information on

- The  large grill operating mode
- Grilling table

Caution



There is a risk of damage to kitchen units if you grill with the appliance door open. The adjacent units may be damaged by the extreme heat. Keep the appliance door closed when using the grill.

Notes:

- Always use the stepped wire rack and the universal pan when grilling
- Place the stepped wire rack in the universal pan and slide them both in at the height specified in the grilling table
- Always place the food to be grilled in the centre of the stepped wire rack
- If you are grilling more than one piece of meat, make sure that they are the same sort of meat and that they are of similar thickness and weight
- Brush the items to be grilled with a little oil to taste
- Turn the items after half to two-thirds of the grilling time

Wire rack position

You can influence the grilling result by changing the position of the wire rack.



















Wire rack type/ position	Use
	Place the stepped wire rack in the universal pan with the step pointing downwards: suitable for grilling items that should be well-done
	Place the stepped wire rack in the universal pan with the step pointing upwards: suitable for grilling items that should be rare to medium

Grilling table

The information in the table are guidelines and apply to the enamelled universal pan with stepped wire rack. The values may vary depending on the type and amount of food to be grilled.







You should set the lower of the specified temperatures the first time. This will generally allow more even browning.

The values are for food placed in a cold oven and for meat taken directly from the refrigerator.

Meal	Oven	Setting	Level	Temperature in °C	Time in minutes
Beef					
Steaks, high 2- 3 cm			2	270*	1st side: 10 - 13 2nd side: 6 - 8
Burgers, high 1 - 2 cm			2	270	1st side: 10 - 12 2nd side: 6 - 8
Lamb					
Steaks, high 2 - 3 cm			2	270	1st side: 6 - 8 2nd side: 4 - 6
Chops, high 2 - 3 cm			2	270	1st side: 7 - 9 2nd side: 5 - 8
Pork					
Steaks, high 1 - 2 cm			2	270*	1st side: 9 - 12 2nd side: 6 - 8
Chops, high 2 - 3 cm			2	270	1st side: 10 - 13 2nd side: 8 - 12
Burgers, high 1 - 2 cm			2	270	1st side: 10 - 12 2nd side: 6 - 8
Sausages, ø 2 - 4 cm			2	270	14 - 18**
Gammon					
Steaks, high 1 - 2 cm			2	270	1st side: 10 - 12 2nd side: 5 - 7



* Preheat for 3 minutes

** Turn frequently

Meal	Oven	Setting	Level	Temperature in °C	Time in minutes
Chicken					
Drumsticks			2	250	1st side: 16 - 20 2nd side: 12 - 15
Breast (boneless)			2	250	1st side: 13 - 15 2nd side: 8 - 10
Fish					
Filets			1	220	1st side: 9 - 13 2nd side: 8 - 12
* Preheat for 3 minutes					
** Turn frequently					

Defrosting

In this section, you can read about

- how to defrost with Circotherm® hot air 
- how to use the defrost setting 

Defrosting with Circotherm® hot air

Use Circotherm® hot air  to defrost and cook frozen products. Please note the following points here:

- Frozen products that have been defrosted (meat in particular) require shorter cooking times than fresh products
- The cooking time for frozen meat increases by the defrosting time
- Always defrost frozen poultry before cooking, so that the giblets can be removed
- Cook frozen fish at the same temperatures as fresh fish
- You can place large quantities of ready made frozen vegetables in aluminium dishes in the cooking compartment at the same time

- Use shelf position 1 when defrosting on one level, and shelf positions 1 + 3 when using two levels
- Observe the manufacturer's instructions when using frozen foods

Defrost table

Frozen meals	Temperature in °C	Defrosting time in minutes
Raw frozen products/ foods	50	30 -90
Bread/bread rolls (750 - 1500 g)	50	30 - 60
Dry, frozen tray bakes	60	45 - 60
Moist, frozen tray bakes	50	50 - 70

Defrost setting

With this operating mode you can defrost delicate baked goods (e.g. cream cakes) particularly well.

1. Switch on the defrost setting .
2. Defrost frozen products for 25 - 45 minutes, depending on the type and size.
3. Remove the frozen product from the cooking compartment and allow it to defrost for a further 30 - 45 minutes.

Note:

With small quantities (pieces) the defrosting time is shortened to 15 - 20 minutes and the extended defrosting time is shortened to 10 - 15 minutes.

Yoghurt



You can also make home-made yoghurt with your appliance. The heat from the  interior lighting is used for this.

Use the lower oven for yoghurt.

1. Remove accessories and hook-in rack, telescopic shelf or individual connector system.
2. Heat up 1 litre UHT milk (3.5 % fat) or pasteurised fresh milk to 40 °C

or

Bring 1 litre of fresh milk to the boil and allow to cool down to 40 °C.

3. Add 300 g set yoghurt to the heated milk, stir it in and pour equal amounts into glasses or bowls. Do not add more than 200 ml to a container.
4. After filling, cover the containers with a suitable lid or cling film.
5. Place and arrange the containers evenly spaced over the whole cooking compartment floor.
6. Close the appliance door and switch on the  interior light.
7. After 7 hours, switch off the  interior light and place the containers in the refrigerator for at least 18 hours.

Cleaning and care

In this section, you will find information on

- Cleaning and care of your appliance
- Cleaning agents and aids
- Self-cleaning surfaces in the cooking compartment.



Risk of short-circuit. Do not use high-pressure cleaners or steam jet cleaners to clean your appliance.

Caution!

Damage to surfaces. Do not use sharp or abrasive cleaning agents. Do not use abrasive cleaning aids such as steel wool or scourers.

Note:

Highly recommended cleaning and care products can be purchased through our after-sales service. Observe the manufacturer's instructions.

Cleaning the appliance exterior

Appliance part/surface	Cleaning agent/aid
Stainless steel surfaces	Apply commercially available detergent with a soft, damp cloth or chamois leather; dry with a soft cloth. Use cleaners for matted stainless steel if very dirty.
Painted surfaces	Apply commercially available detergent with a soft, damp cloth or chamois leather; dry with a soft cloth.
Glass surfaces	Apply commercially available detergent with a soft, damp cloth or chamois leather; dry with a soft cloth.
Door panels	Use commercially available glass cleaner or apply commercially available detergent with a soft, damp cloth or chamois leather; dry with a soft cloth. The inner door panel on the appliance door has a coating which reduces the temperature and reflects the heat. The view through the appliance door is not impaired by this. When the appliance door is open this coating can have the effect of a light-coloured film. This is part of the design and is not due to any quality defect.

Cleaning the cooking compartment

Caution!

Damage to surfaces. Do not clean the appliance while still warm, even if using oven cleaners specially intended for this purpose.

Notes:

- Enamel is baked on at very high temperatures during manufacture. This can cause some slight colour variation. This is normal and does not affect proper functioning.
- The edges of thin trays cannot be completely enamelled. As a result, these edges can be rough. Anti-corrosion protection is still guaranteed, however.

Appliance part	Cleaning agent/aid
Enamel surfaces (smooth surfaces)	<p>To facilitate cleaning you can switch on the interior lighting and detach the appliance door if necessary.</p> <p>Apply commercially available detergent or vinegar solution with a soft, damp cloth or chamois leather; dry with a soft cloth.</p> <p>Loosen baked on food residues with a damp cloth and detergent.</p> <p>We recommend using oven cleaning gel if the oven is very dirty. This can be applied neat to the stain.</p> <p>Leave the cooking compartment open to dry after cleaning.</p>
Self-cleaning surfaces (rough surfaces)	Please observe the instructions in the section: Self-cleaning surfaces
Door seal	Hot soapy water
Hook-in rack/telescopic shelf	Hot soapy water
Accessories	Soak in hot soapy water, clean with a brush and sponge or wash in the dishwasher

Keeping the appliance clean

To avoid getting the cooking compartment dirty,

- clean the cooking compartment after each use, as dirt will bake on the next time it is heated up, and this can only be removed with difficulty
- always remove lime, grease, starch and egg-white stains immediately
- where possible use Circotherm® hot air . This operating mode creates less dirt
- use the universal pan to bake very moist cakes
- use suitable ovenware when roasting (e.g. roasting dish) or a roasting sheet (see the section: Accessories)

Self-cleaning surface

The back panel in the main oven  is coated with self-cleaning enamel. This coating absorbs and disintegrates splashes from baking and roasting while the oven is in operation.

Large splashes only disappear after the oven has been used several times.

Discolouration on the rear wall does not affect the self-cleaning function.

Caution

Damage to the self-cleaning surface due to the application of oven cleaner.

- Never clean the self-cleaning surface with oven cleaner.
- If oven cleaner is accidentally applied to the self-cleaning surface, remove it immediately with a sponge and plenty of water.

Caution

Damage to surfaces on self-cleaning areas due to the use of abrasive and acidic cleaning agents and aids.

- Do not use cleaning agents containing abrasive substances or acids.
- Do not use abrasive cleaning aids such as steel wool or scourers.

Removing and fitting the appliance door



You can remove the appliance door to clean it more thoroughly.

Risk of injury!

The hinges on the appliance door can snap back with great force. Always open the locking lever on the hinge fully when removing the appliance door and close it again fully after fitting it. Do not reach into the hinge.



Risk of injury!

If the appliance door is detached on one side, do not reach into the hinge. The hinge can snap back with great force. Call the after-sales service.

Removing the appliance door

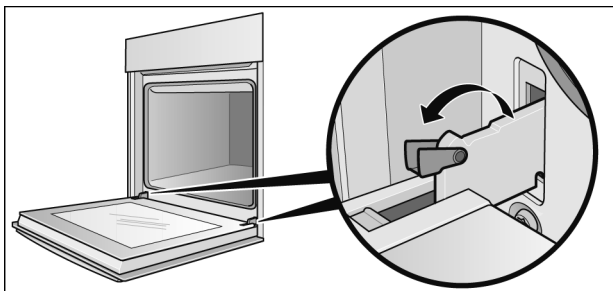

1. Open the appliance door fully.
2. Open the locking levers on the left and right-hand side fully.

The hinges are secured and cannot snap closed.

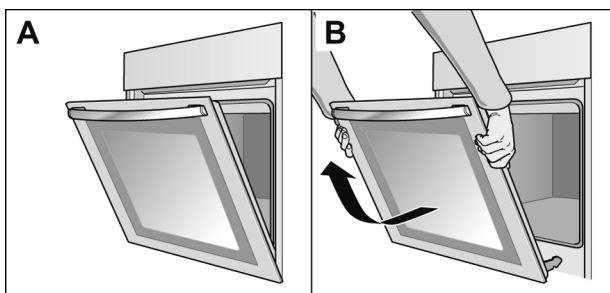

3. Close the appliance door only until resistance becomes noticeable (Fig. A).
4. With both hands, grip the door on the left and right-hand side, close the door a little more and pull it out (Fig. B).

Fitting the appliance door

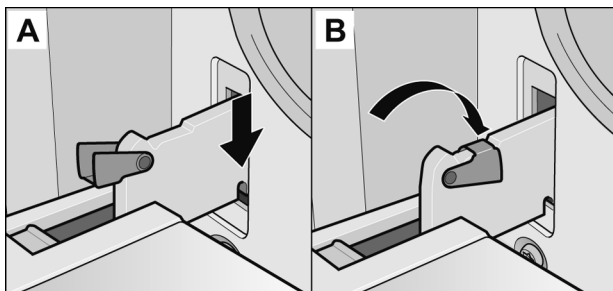

1. Insert the hinges in the left and right-hand holders (Fig. A).
The notch on both hinges must engage.
2. Open the appliance door fully.
3. Close the locking levers on the left and right-hand side fully (Fig. B).
The appliance door is secured and can no longer be removed.
4. Close the appliance door.

Cleaning the door panels

To facilitate cleaning, you can remove the inner door panels from the appliance door.



Risk of injury.

The components inside the appliance door may have sharp edges. Take care not to cut yourself. Wear protective gloves.

Caution

The appliance must not be used again until the door panels and appliance door have been correctly fitted.

Removing the door panel

Before removing, make a note of the position in which the door panel is fitted, so that they are not refitted the wrong way round.

1. Remove the appliance door and lay it on a soft, clean surface, with the front facing down (see section: Removing and fitting the appliance door).

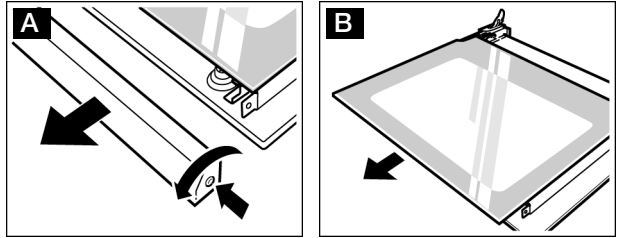

2. Unscrew the cover at the top left and right of the appliance door and detach it (Fig. A).
3. Lift the door panel and pull it out (Fig. B).

Removing the intermediate panel

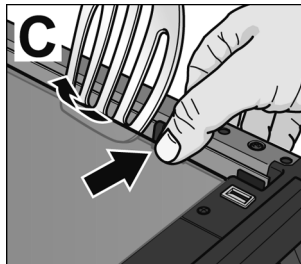

1. Push the intermediate panel bracket on one side and unlatch the panel using a tool such as a spatula (Fig. C).
2. Unlatch the other side in the same way and remove the intermediate panel.

Cleaning

Clean the door panels with glass cleaner and a soft cloth.

Caution

Do not use any sharp or abrasive medium or a glass scraper. The glass could become damaged.

Fitting the intermediate panel

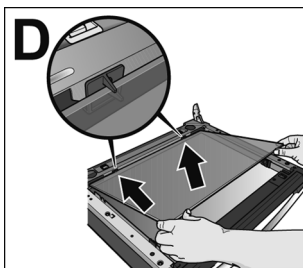

1. Place the intermediate panel in the supports on the left- and right-hand sides (Fig. D).
2. Push the intermediate panel down into the brackets.

Fitting the door panel

1. Push the door panel in as far as the stop.
2. Replace the cover and screw it in place.
3. Refit the appliance door.

Cleaning hook-in racks

For easier cleaning, you can remove the hook-in racks.



Risk of burning due to hot elements in the cooking compartment. Wait until the cooking compartment has cooled down.

Remove hook-in rack

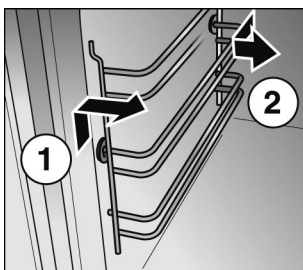

1. Push the hook-in rack upwards at the front and unhook to the side.
2. Pull the hook-in rack forwards at the rear and unhook to the side.

Cleaning hook-in racks

Clean hook-in racks with detergent and a sponge or brush.

Hanging hook-in racks

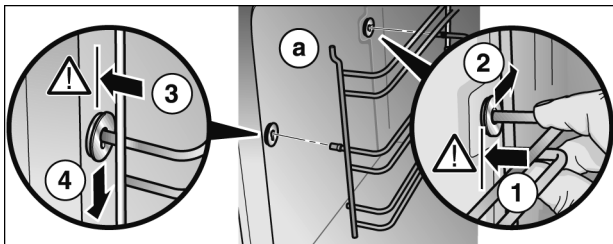

Always install the hook-in rack with the indentation (a) facing upwards, so that the shelf positions match.

1. Insert the hook-in rack at the rear until the limit stop.
2. Push the hook-in rack towards the rear.
3. Insert the hook-in rack at the front until the limit stop.
4. Push the hook-in rack downwards.

Faults and repairs

It is not always necessary to call the after-sales service. In some cases, you can take remedial action yourself. You will find some tips for troubleshooting in the following table.



Risk of electric shock.

- Work on the appliance electronics must only be carried out by an expert
- During work on the appliance electronics, the power supply to the appliance must be disconnected. Switch off the circuit breaker or take out the fuse in your household fuse box

Problem	Possible cause	Remedial action
There is no electrical function (e.g. indicator lamp does not light up)	Blown fuse	Check the fuses in the fuse box and replace if necessary
Liquid or thin dough runs to one side	Appliance not installed level	Check the appliance installation (see the Installation instructions)
0:00 flashes in the clock display	There was a power cut	Reset the clock (see section: Electronic clock)
Electronically controlled functions are malfunctioning	Energy surges (e.g. lightning strike)	Reset the function concerned
Smoke is generated during roasting or grilling	Fat is burning on the grill element	Continue grilling or roasting until the fat on the grill element is burnt away
	Wire rack or universal pan inserted incorrectly	Place the wire rack in the universal pan and insert them together into a low shelf height
High levels of condensation are generated in the cooking compartment	Normal occurrence (e.g. with cakes with very moist toppings or a large roast joint)	Open the appliance door occasionally during operation
Enamelled accessories have light, matt marks	Normal occurrence caused by dripping meat or fruit juices	Not possible
Door panels are misted up	Normal occurrence caused by temperature differences	Heat the appliance up to 100 °C and then switch off again after 5 minutes

Replacing the cooking compartment bulb



Replace faulty cooking compartment bulbs. Spare bulbs can be obtained from the after-sales service or specialist retailers.

Risk of electric shock.

Disconnect the appliance from the power supply. Switch off the circuit breaker or take out the fuse in the household fuse box.

Bottom oven

Only use these bulbs for the bottom oven:

E14, 230 - 240 V, 25 W, heat resistant up to 300 °C.

1. Remove hook-in racks, telescopic shelves or individual fitting systems from the left-hand side.
2. Place a tea towel in the cold cooking compartment to prevent damage.

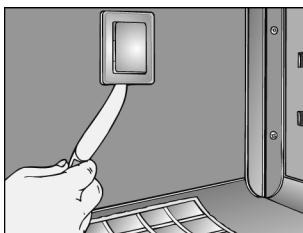

3. Remove the lamp cover. To do so, insert a knife or similar between the lamp cover and mounting frame.
4. Replace the bulb with one of the same type.
5. Insert the lamp cover into the mounting frame.
6. Fit the hook-in racks, telescopic shelves or individual fitting systems.
7. Remove the tea towel and switch on the circuit breaker.

Top oven

Only use these bulbs for the top oven:
E14, 220 - 240 V, 40 W, heat resistant up to 300 °C.

1. Place a tea towel in the cold cooking compartment to prevent damage.

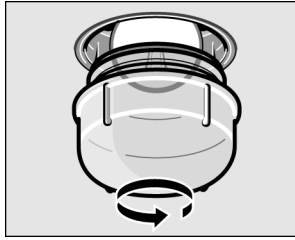

2. Turn the glass cover anticlockwise and remove it.
3. Replace the bulb with one of the same type.
4. Screw the glass cover back on.
5. Remove the tea towel and switch on the circuit breaker.

Changing the door seal

If the door seal is defective, it must be replaced. Replacement seals for your appliance can be obtained from the after-sales service.

Unhooking the door seal

The door seal is fixed in five places.

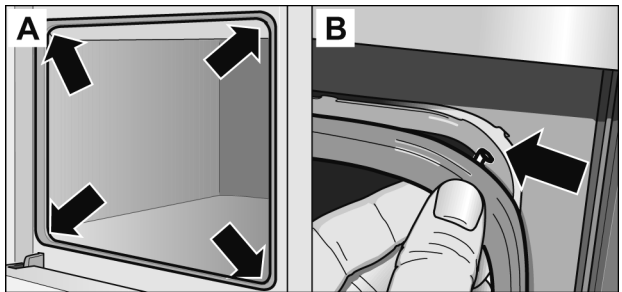

1. Unhook the door seal (figure B) at four places (figure A).

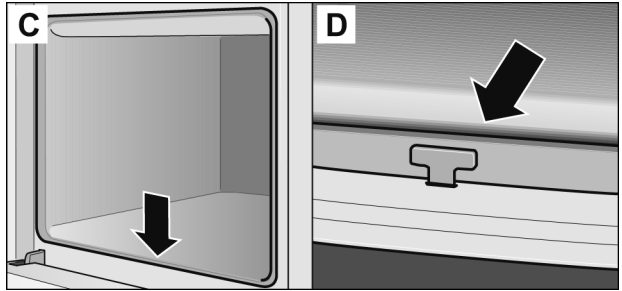

2. Unhook the door seal at the bottom (figure C) by gently turning (figure D).

Hooking in the door seal

1. Hook the door seal in (figure B) at four places (figure A).
2. Hook the door seal at the bottom (figure C) by gently turning (figure D).
3. Check that the door seal is seated correctly.

After-sales service

In the event of faults and repairs that you cannot solve yourself, please use our after-sales service.

You can find the addresses in the after-sales service directory.

Note:

You will be charged for calling the after-sales service regarding an operating fault.

E number and FD number













For after-sales service cases, please specify the E-number and FD number.

You can find these on the rating plate behind the appliance door on the left-hand bottom edge.

E-Nr.	FD
--------------	-----------

Test dishes

Dishes tested in accordance with standard EN 60350. Please note the information in the tables about preheating.

Baking	Cookware	Oven	Setting	Level	Temperature in °C	Time in minutes
Shortbread						
■ 1 level	Baking tray***			1	140 - 150**	20 - 30
■ 2 levels	2 baking trays***			1 + 3	140 - 150**	20 - 30
Small cakes (20 pieces)						
■ 1 level	Baking tray***			1	150 - 160*	20 - 30
■ 2 levels	2 baking trays***			1 + 3	150 - 160*	25 - 35
Fatless sponge cake	Springform cake tin ø 26 cm			1	160 - 170**	25 - 35
Apple pie						
■ 1 level (see figure)	2 x Springform cake tin ø 20 cm			1	170 - 180**	70 - 80









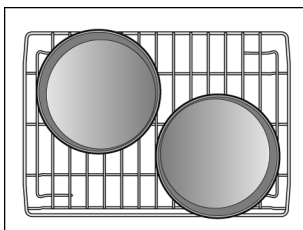



* Preheat for 10 minutes

** Preheat oven

*** Only use original baking trays, order no. Z1342X0

When baking apple pies using CircoTherm® , always place the two springform cake tins diagonally on the stepped wire rack.



Grilling	Oven	Wire rack position	Setting	Level	Temperature in °C	Time in minutes
White bread (universal pan + stepped wire rack)				3	275*	1 - 2
				2	275*	1 - 2
Beefsteaks (universal pan + stepped wire rack)				3	270	25 - 30**
				2	270	25 - 30**

* Preheat for 10 minutes

** Turn after $\frac{2}{3}$ of the time

