

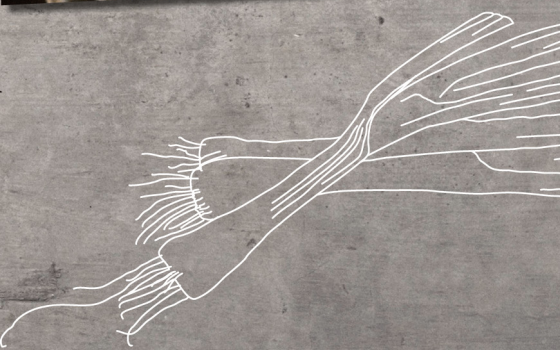

















FRIDGE-FREEZER

en User manual

**KI567.. / KI577.. / KI585.. /
KI586.. / KI587..**



en Table of contents

 Safety instructions	3	 Refrigerator compartment.	11
About these instructions	3	Note when storing food	11
Risk of explosion	3	Note the chill zones in the refrigerator compartment	12
Risk of electric shock	3	Vegetable container	12
Risk of cold burns	3	 Freezer compartment.	12
Risk of injury	3	Maximum freezing capacity	12
Danger due to refrigerants.	4	Fully utilising the freezer volume	13
Avoiding placing children and vulnerable people at risk	4	Purchasing frozen food	13
Damage.	4	Note when loading products	13
Weight	5	Freezing fresh food	13
 Intended use	5	Thawing frozen food.	14
 Environmental protection	5	 Defrosting	14
Packaging	5	Refrigerator compartment	14
Old appliances	5	Freezer compartment	15
 Installation and connection	6	 Cleaning	15
Contents of package	6	Cleaning the equipment	16
Technical specifications.	6	 Odours	16
Installing the appliance	6	 Lighting	16
Cavity depth.	6	 Noises	16
Side by-side installation	6	Normal noises	16
Tips for saving energy	7	Preventing noises.	16
Before using your appliance for the first time.	8	 Faults – what to do?	17
Electrical connection	8	 Customer service	18
 Getting to know your appliance 8		Appliance self-test	18
Appliance.	8	Repair order and advice on faults	18
Controls	9	Guarantee	18
Interior fittings	9	 Operating the appliance.	10
 Operating the appliance.	10	Switching on the appliance	10
Switching on the appliance	10	Switching off and disconnecting the appliance	10
Switching off and disconnecting the appliance	10	Setting the temperature	10
Setting the temperature	10	Super function	11
Super function	11		



Safety instructions

This appliance complies with the relevant safety regulations for electrical appliances and is fitted with noise suppression.

The refrigeration circuit has been checked for leaks.

About these instructions

- Read and follow the operating and installation instructions. They contain important information on how to install, use and maintain the appliance.
- The manufacturer is not liable if you disregard the instructions and warnings in the operating and installation instructions.
- Retain all documents for subsequent use or for the next owner.

Risk of explosion

- Never use electric devices inside the appliance (e.g. heaters or electric ice makers).
- Do not store products which contain flammable propellants (e.g. spray cans) or explosive substances in the appliance.
- Store high-percentage alcohol tightly closed and standing up.

Risk of electric shock

Improper installations and repairs may put the user at considerable risk.

- If the power cord is damaged: Immediately disconnect appliance from the power supply.
- Have the appliance repaired by the manufacturer, customer service or a similarly qualified person only.
- Use original parts supplied by the manufacturer only. The manufacturer guarantees that these parts satisfy the safety requirements.
- Only purchase an extension cable from customer service.

Risk of cold burns

- Never put frozen food straight from the freezer compartment into your mouth.
- Avoid prolonged contact of skin with frozen food, ice and the tubes in the freezer compartment.

Risk of injury

Containers which contain carbonated drinks may burst. Do not store containers which contain carbonated drinks in the freezer compartment.

Danger due to refrigerants

The tubes of the refrigeration circuit contain a small quantity of the environmentally friendly but flammable refrigerant R600a. It does not damage the ozone layer and does not increase the greenhouse effect. If refrigerant escapes, it may injure your eyes or ignite.

- Do not damage the tubes

If the tubes are damaged:

- Keep naked flames and ignition sources away from the appliance.
- Ventilate the room.
- Switch off the appliance and pull out the mains plug.
- Call the after-sales service.

Avoiding placing children and vulnerable people at risk

At risk are:

- Children,
- People who have limited physical, mental or sensory abilities,
- People who have inadequate knowledge concerning safe operation of the appliance.

Measures:

- Ensure that children and vulnerable people have understood the hazards.
- Children or vulnerable people must be supervised by a responsible person when using the appliance.
- Only children from 8 years and above may use the appliance.
- Supervise children while the appliance is being cleaned or maintained.
- Never allow children to play with the appliance.

Risk of suffocation

- If the appliance features a lock: keep the key out of the reach of children.
- Keep children away from the packaging and its parts.

Damage

To prevent damage:

- Do not stand or support yourself on the base, runners or doors.
- Keep plastic parts and door seals free of oil and grease.
- Pull the mains plug – not the power cord.

Weight

When installing and transporting the appliance, note that it may be very heavy.

→ "Installation location" on page 6



Intended use

Use this appliance

- only for the cooling and freezing of food and for making ice.
- only in the home and in the home environment.
- only according to these operating instructions.

This appliance is intended for use up to a maximum height of 2000 metres above sea level.



Environmental protection

Packaging

All materials are environmentally safe and recyclable:

- Dispose of packaging in an environmentally friendly manner.
- Please ask your dealer or inquire at your local authority about current means of disposal.

Old appliances

Valuable raw materials can be reclaimed by recycling old appliances.



Warning Children may become locked in the appliance and suffocate!

- To prevent children from climbing in, leave shelves and containers in the appliance.
- Keep children away from the redundant appliance.

Caution! Refrigerant and harmful gases may escape.

Do not damage the tubes of the refrigerant circuit and insulation.

1. Remove the mains plug.
2. Sever the power cord.
3. Have the appliance disposed of professionally.



This appliance is labelled in accordance with European Directive 2012/19/EU concerning used electrical and electronic appliances (waste electrical and electronic equipment - WEEE). The guideline determines the framework for the return and recycling of used appliances as applicable throughout the EU.



Installation and connection

Contents of package

After unpacking all parts, check for any damage in transit.

If you have any complaints, contact the dealer from whom you purchased the appliance or our after-sales service.

→ "Customer service" on page 18

The delivery consists of the following parts:

- Built-in appliance
- Interior fittings (depending on model)
- Installation material
- User manual
- Installation instructions
- Customer service booklet
- Warranty enclosure
- Information on the energy consumption and noises

Technical specifications

Refrigerant, cubic capacity and further technical specifications can be found on the rating plate.

→ "Getting to know your appliance" on page 8

Installing the appliance

Installation location

The more refrigerant an appliance contains, the larger the room must be in which the appliance is situated.

Leaking refrigerant can form a flammable gas-air mixture in rooms which are too small.

The room must be at least 1 m³ per 8 g of refrigerant. The amount of refrigerant in your appliance is indicated on the rating plate inside the appliance.
→ "Getting to know your appliance" on page 8

The weight of the appliance may be up to 75 kg depending on the model.

Permitted room temperature

The permitted room temperature depends on the climatic class of the appliance.

Information on the climatic class can be found on the rating plate.

→ "Getting to know your appliance" on page 8

Climatic category	Permitted room temperature
SN	+10 °C ... 32 °C
N	+16 °C ... 32 °C
ST	+16 °C ... 38 °C
T	+16 °C ... 43 °C

The appliance is fully functional within the permitted room temperature.

If an appliance of climatic class SN is operated at colder room temperatures, the appliance will not be damaged up to a room temperature of +5 °C.

Cavity depth

A cavity depth of 56 cm is recommended for the appliance. If the cavity depth is smaller – at least 55 cm – the energy consumption increases slightly.

Side by-side installation

It is only possible to install appliances side by side with a gap of at least 15 cm.

Tips for saving energy

If you follow the instructions below, your appliance will use less power.

Note: The arrangement of the features does not affect the energy consumption of the appliance.

Installing the appliance

Keep the appliance out of direct sunlight.

The appliance must cool less frequently at low ambient temperatures and therefore consumes less power.

Install the appliance as far away as possible from heating elements, cooker and other heat sources:
3 cm to electric or gas cookers.
30 cm to an oil or solid-fuel cooker.

Note: If this is not possible, attach an insulating plate between the appliance and heat source.

Select an installation location at a room temperature of approx. 20 °C.

Use a cavity depth of 56 cm.

The air on the rear panel of the appliance does not warm up so intensely. The appliance consumes less power if the warm air can escape.

Caution!

Risk of burns!

Individual parts of the appliance become hot during operation. Touching these parts may result in burns.

Do not cover or block the ventilation openings.

Ventilate the room daily.

Using the appliance

Open the appliance door only briefly.

The air in the appliance does not warm up so intensely. The appliance must cool less frequently and therefore consumes less power.

Transport purchased food in a cool bag and place quickly in the appliance.

Allow warm food and drinks to cool down before placing in the appliance.

Thaw frozen food in the refrigerator compartment in order to utilise the low temperature of the frozen food.

Always leave a space between the food and the rear panel.

The air can circulate and the air humidity will remain constant. The appliance must cool less frequently and therefore consumes less power.

Pack food airtight.

Vacuum the back of the appliance once a year.

The air on the rear panel of the appliance does not warm up so intensely. The appliance consumes less power if the warm air can escape.

Do not cover or block the ventilation openings.

Before using your appliance for the first time

1. Remove leaflets, adhesive tape and protective film.
2. Clean the appliance.
→ "Cleaning" on page 15

Electrical connection

Caution!

Do not connect the appliance to electronic energy saver plugs.

Note: You can connect the appliance to mains-controlled and sine-controlled inverters.

Mains-controlled inverters are used for photovoltaic systems which are connected directly to the national grid. Sine-controlled inverters must be used for isolated applications. Isolated applications, e.g. on ships or in mountain lodges, which are not connected directly to the national grid.

1. After installing the appliance, wait at least 1 hour before connecting it to prevent damaging the compressor.
2. Connect the appliance via a correctly installed socket.
The socket must comply with the following data:
Socket with 220 V ... 240 V
Conductor 50 Hz
Fuse 10 A ... 16 A
Outside Europe: Check whether the indicated current type of the appliance corresponds with the values of your power supply.
Appliance specifications are on the rating plate.
→ "Getting to know your appliance" on page 8
3. Connect the appliance to a socket near the appliance.
The socket must be freely accessible even after the appliance has been installed.

Getting to know your appliance

Fold out the last page with the diagrams. The appliance and diagrams may differ according to features.

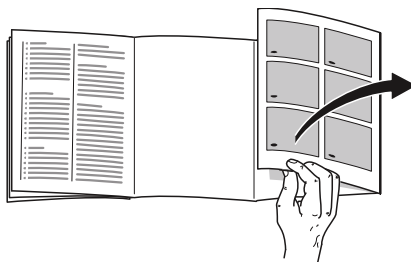

Appliance

→ Fig. 1

* Not all models.

<input type="checkbox"/> A	Refrigerator compartment
<input type="checkbox"/> B	Freezer compartment
<input type="checkbox"/> 1 ... <input type="checkbox"/> 4	Controls
<input type="checkbox"/> 5	Lighting
<input type="checkbox"/> 6*	Extendable shelf
<input type="checkbox"/> 7	Vegetable container
<input type="checkbox"/> 8	Rating plate
<input type="checkbox"/> 9*	Berry tray
<input type="checkbox"/> 10	Freezer calendar
<input type="checkbox"/> 11	Frozen food container
<input type="checkbox"/> 12*	Butter and cheese compartment
<input type="checkbox"/> 13	Tray for large bottles

Controls

→ Fig. **2**

- 1** Button **⓪**
Switches the appliance on or off.
- 2** Refrigerator compartment temperature display
Indicates the set temperature in °C.
- 3** **super** display
This is lit when the Super function is switched on.
- 4** °C button
Sets the temperature.

Interior fittings

(not all models)

Shelf

→ Fig. **3**

You can vary the shelf:

- Pull out and remove the shelf.

Vario shelf

→ Fig. **4**

You can store tall items (e.g. cans or bottles):

- Take out the front part of the shelf and push under the rear part.

Extendable shelf

→ Fig. **5**

You can give yourself a better overview:

- Pull out a shelf.

You can completely remove the shelf:

1. Press and hold down both buttons under the shelf.
2. Pull out the shelf, lower and swing out to the side.

Container

→ Fig. **6**

You can remove the container:

- Pull out the container all the way, lift at the front and remove.

Butter and cheese compartment

→ Fig. **7**

The compartment is easy to open:

- Lightly press the flap below in the middle.

The compartment opens downwards. The flap is pushed under the compartment.

Storage compartment

→ Fig. **8**

You can remove the storage compartment:

- Lift up storage compartment and remove.

Freezer calendar

→ Fig. **1**/**10**

The freezer calendar indicates the maximum storage duration in months at a constant temperature of -18 °C .

Ice cube tray

You can make ice cubes:

1. Fill the ice cube tray 3/4 full with water and place in the freezer compartment.

Note: If the ice cube tray is stuck to the freezer compartment, loosen with a blunt implement only (e.g. spoon handle).

2. To loosen the ice cubes, twist the ice cube tray slightly or hold briefly under flowing water.

en Operating the appliance

Ice pack

In the event of a power failure or a fault:

- The ice pack delays the warming of the stored frozen food.

Note: The longest storage time is obtained by placing the ice pack on the food in the top compartment.

You can take out the ice pack for temporarily keeping food cool, e.g. in a cool bag.



Operating the appliance

Switching on the appliance

1. Press the ① button.
The appliance begins to cool.
2. Set the required temperature.
→ "Setting the temperature" on page 10

Operating tips

- After the appliance has been switched on, it may take several hours until the set temperatures have been reached. Do not put in any food until the selected temperature has been reached.
- The sides of the housing are partly heated slightly. This prevents condensation in the area of the door seal.
- If the freezer compartment door cannot be immediately re-opened after it has been closed, wait until the resulting low pressure has equalised.

Switching off and disconnecting the appliance

Switching off the appliance

- Press the ① button.
The appliance no longer cools.

Disconnecting the appliance

If you do not use the appliance for a prolonged period:

1. Press the ① button.
The appliance no longer cools.
2. Pull out the mains plug or switch off the fuse.
3. Clean the appliance.
4. Leave the appliance open.

Setting the temperature

Recommended temperature

Refrigerator compartment: +4 °C

Refrigerator compartment

- Keep pressing the button °C until the display indicates the required temperature.

Freezer compartment

The temperature in the refrigerator compartment will affect the temperature in the freezer compartment. Change the temperature in the refrigerator compartment in order to change the temperature in the freezer compartment. Temperatures which are set higher in the refrigerator compartment will increase temperatures in the freezer compartment.

Sticker OK

(not all models)

You can use sticker **OK** to check whether the temperature in the refrigerator compartment reaches +4 °C or lower.

If the sticker does not indicate **OK**, gradually reduce temperature.

When the appliance is switched on, it may take up to 12 hours until the set temperature is reached.

Correct setting**Super function**

When the Super function is switched on, the freezer compartment and refrigerator compartment will become colder.

Starting the Super function, e.g.:

- to freeze food solid as quickly as possible
- 4 ...6 hours before freezing food weighing 2 kg or more
- to use the max. freezing capacity → *"Maximum freezing capacity" on page 12*

Note: When Super cooling is switched on, increased operating noise may occur.

After approx. 2 ½ days the appliance switches to normal operation.

Starting/ending Super function:

- Press the °C button.
The **super** display lights up when the Super function is switched on.



Refrigerator compartment

The refrigerator compartment is suitable for storing meat, sausages, fish, dairy products, eggs, ready meals and pastries.

The temperature can be set from +2 °C ... +8 °C.

The refrigerator compartment can also be used to store highly perishable foods in the short to medium term. The lower the selected temperature, the slower the enzymatic and chemical processes and deterioration by microorganisms. A temperature of +4 °C or lower ensures optimum freshness and safety of the stored foods.

Note when storing food

- Store fresh, undamaged food.
The quality and freshness will then be retained for longer.
- In the case of ready products and bottled goods do not exceed the minimum sell-by date or use-by-date indicated by the manufacturer.
- To retain aroma, colour and freshness, pack or cover food well before placing it in the appliance.
This avoids transference of flavours and discolouration of the plastic parts.
- Leave warm food and drinks to cool down before placing them in the refrigerator compartment.

Note the chill zones in the refrigerator compartment

The air circulation in the refrigerator compartment creates different chill zones.

Coldest zone

The coldest zone is between the arrow stamped on the side and the shelf underneath.

→ Fig. 9

Note: Store perishable food (e.g. fish, sausages and meat) in the coldest zone.

Warmest zone

The warmest zone is at the very top of the door.

Note: Store e.g. hard cheese and butter in the warmest zone. Cheese can continue to release its flavour and the butter will still be easy to spread.

Vegetable container

→ Fig. 1/7

The vegetable container is the best storage location for fresh fruit and vegetables. A high air humidity keeps leafy vegetables fresh for longer. Fruit and vegetables should be stored at a slightly lower air humidity.

Notes

- Fruit sensitive to cold (e.g. pineapple, banana, papaya and citrus fruit) and vegetables sensitive to cold (e.g. aubergines, cucumbers, zucchini, peppers, tomatoes and potatoes) should be stored outside the refrigerator at temperatures of approx. +8 °C - +12 °C for optimum preservation of quality and flavour.

- Condensation may form in the vegetable container depending on the food and quantity stored. Remove condensation with a dry cloth.



Freezer compartment

The freezer compartment is suitable for:

- storing frozen food
- making ice cubes
- freezing food

The temperature in the freezer compartment depends on the temperature in the refrigerator compartment.

The freezer compartment can be used to store perishable foods long-term almost without any noticeable reduction in quality as the low temperatures considerably slow down or stop deterioration. Appearance, flavour and all valuable ingredients are largely retained.

The time between putting fresh food in the freezer compartment and it freezing solid depends on the following factors:

- set temperature
- type of food
- amount of food in the freezer compartment
- quantity and type of storage

Maximum freezing capacity

The maximum freezing capacity indicates the quantity of food that can be frozen solid within 24 hours.

Information about the maximum freezing capacity can be found on the rating plate.

→ "Getting to know your appliance" on page 8

Prerequisites for max. freezing capacity

1. Approx. 24 hours before inserting fresh produce: switch on the Super function.
2. Freeze fresh food as close as possible to the side panels.

Fully utilising the freezer volume

To place the maximum quantity of frozen food in the freezer compartment:

- remove all fittings.
- Store food directly on the shelves and on the floor of the freezer compartment.

Purchasing frozen food

- Ensure the packaging is not damaged.
- Do not exceed the minimum sell-by date.
- The temperature in the supermarket freezer must be $-18\text{ }^{\circ}\text{C}$ or lower.
- If possible, transport frozen food in a cool bag and place quickly in the freezer compartment.

Note when loading products

- Freeze larger quantities of food in the lower frozen food containers. This is where the food will freeze especially quickly and gently.
- Distribute food in the compartments or frozen food containers.
- Do not bring food which is to be frozen into contact with frozen food. If required, restack frozen food in the frozen food containers.
- Important for unrestricted air circulation in the appliance: push in frozen food containers up to the limit stop.

Freezing fresh food

Freeze only fresh and undamaged food.

Food which is boiled, fried or baked is more suitable for freezing than food which is raw.

Before freezing food, make preparations appropriate to the food in order to retain the best possible nutritional value, flavour and colour:

- Vegetables: wash, chop, blanch.
- Fruit: wash, pit and perhaps peel, possibly add sugar or ascorbic acid solution.

Information on how to do this can be found in the relevant literature.

Suitable for freezing

- Baked goods
- Fish and seafood
- Meat
- Poultry and game
- Vegetables, fruit and herbs
- Eggs without shells
- Dairy products, e.g. cheese, butter and quark
- Ready meals and leftovers, e.g. soups, stews, cooked meat and fish, potato dishes, soufflés and desserts

Not suitable for freezing

- Types of vegetables which are usually eaten raw, e.g. lettuce or radishes
- Unpeeled or hard boiled eggs
- Grapes
- Whole apples, pears and peaches
- Yoghurt, soured milk, sour cream, creme fraiche and mayonnaise

Packing frozen food

The correct type of packaging and material selection are decisive factors in the retention of the product quality and prevent the development of freezer burn.

1. Place food in packaging.
2. Remove air.
3. Pack food airtight to prevent it from losing flavour and drying out.
4. Label packaging with contents and date of freezing.

Suitable packaging:

- Plastic film
- Tubular film made of polyethylene (PE)
- Aluminium foil
- Freezer containers

Suitable locks:

- Rubber bands
- Plastic clips
- Cold-resistant adhesive tape

Not suitable packaging:

- Wrapping paper
- Greaseproof paper
- Cellophane
- Refuse bags and used shopping bags

Shelf life of frozen food at $-18\text{ }^{\circ}\text{C}$

Fish, sausage, ready meals and cakes and pastries:	up to 6 months
Meat, poultry:	up to 8 months
Fruit, vegetables:	up to 12 months

Thawing frozen food

The thawing method must be adjusted to the food and application in order to retain the best possible product quality.

Thawing methods:

- in the refrigerator compartment (especially suitable for animal-based foods such as fish, meat, cheese, quark)
- at room temperature (bread)
- in the microwave (food for immediate consumption or immediate preparation)
- in the oven/cooker (food for immediate consumption or immediate preparation)

Caution!

Do not refreeze thawing or thawed food. You can only refreeze the food when it has been used for a ready-to-eat meal (boiled or fried).

The frozen food can no longer be stored for the maximum duration.



Defrosting

Refrigerator compartment

While the refrigerating unit is running, condensation droplets or frost form on the rear panel. This is due to functional reasons. It is not necessary to wipe off the condensation droplets or frost. The rear panel defrosts automatically. The condensation drains off into the condensation channel.

→ Fig. 10

The condensation runs from the condensation channel to the evaporation pan where it evaporates.

Note: Keep the condensation channel and drainage hole clean so that the condensation can drain and odours do not form.

Freezer compartment

As the frozen food may not start thawing, the freezer compartment does not defrost automatically. A layer of hoarfrost in the freezer compartment impairs refrigeration of the frozen food and increases power consumption.

- Remove the layer of frost regularly!

Caution!

Avoid any damage to the pipes of the refrigeration circuit.

If refrigerant escapes, it may injure your eyes or ignite.

- Do not scrape off hoarfrost or ice with a knife or pointed object.

Proceed as follows:

1. Switch on the Super function approx. 4 hours before defrosting.
This means that the food reaches very low temperatures and it can be stored for longer at room temperature.
2. Remove the frozen food and place temporarily in a cool location.
3. Switch off the appliance.
4. Pull out the mains plug or switch off the fuse.
5. To accelerate the defrosting process: place a pan of hot water on a trivet in the freezer compartment.
6. Wipe up the condensation water with a cloth or sponge.
7. Wipe the freezer compartment dry.
8. Switch on the appliance.
9. Put the frozen food back into the appliance.



Cleaning

Caution!

Avoid damaging the appliance and the fittings.

- Do not use abrasive, chloride or acidic cleaning agents or solvents.
- Do not use scouring or abrasive sponges.
The metallic surfaces may corrode.
- Never clean the shelves or containers in the dishwasher.
The parts may become deformed.

Proceed as follows:

1. Switch off the appliance.
2. Pull out the mains plug or switch off the fuse.
3. Take out the food and store in a cool location.
If present: place ice pack on the food.
4. If present: wait until the layer of frost has thawed.
5. Clean the appliance with a soft cloth, lukewarm water and a little pH-neutral washing-up liquid.

Caution!

The rinsing water must not run into the light or through the drainage hole into the evaporation area.

6. Wipe door seal with clear water and dry thoroughly with a cloth.
7. Reconnect and switch on appliance and put in food.

Cleaning the equipment

To clean, take the variable parts out of the appliance.

→ "Interior fittings" on page 9

Condensation channel

→ Fig. 10

Regularly clean the condensation channel and drainage hole with a cotton bud or similar implement to ensure that the condensation can drain.



Odours

If you experience unpleasant odours:

1. Switch off the appliance with the On/Off button ①.
2. Take all food out of the appliance.
3. Clean the inside. → "Cleaning" on page 15
4. Clean all packages.
5. Seal strong smelling food in order to avoid odours from forming.
6. Switch the appliance on again.
7. Store food in the appliance.
8. Check whether the formation of odours is still occurring after 24 hours.



Lighting

Your appliance features a maintenance-free LED light.

Only customer service or authorised technicians may repair the light.



Noises

Normal noises

Droning: A motor is running, e.g. refrigerating unit, fan.

Bubbling, buzzing or gurgling: Refrigerant is flowing through the tubes.

Clicking: Motor, switches or solenoid valves are switching on and off.

Cracking: Automatic thawing successful.

Preventing noises

Appliance is not level: Align appliance using a spirit level. If required, place a little packing underneath.

Containers, shelves or storage compartments wobble or stick: Check the removable fittings and re-insert if required.

Bottles or receptacles are touching each other: Move bottles or receptacles away from each other.

Faults – what to do?

Before you call customer service, use this table to check whether you can rectify the fault yourself.

Temperature differs greatly from the set value.

Switch off appliance for 5 minutes.
 → *"Switching off and disconnecting the appliance" on page 10*
 If the temperature is too warm, check temperature again after a couple of hours.
 If the temperature is too cold, check temperature again on the following day.

Displays do not illuminate.

The mains plug has not been inserted properly.	Connect the mains plug.
The fuse has tripped.	Check the fuses.
The power has failed.	Check whether the power is on.

Appliance is not cooling, display and lighting are lit.

Showroom mode switched on.	Start the appliance self-test. → <i>"Appliance self-test" on page 18</i> When the programme has ended, the appliance switches over to normal operation.
----------------------------	---



Customer service

If you are unable to rectify the fault, please contact our customer service. We will always find an appropriate solution in order to avoid unnecessary visits by engineers.

The contact information for your nearest customer service can be found here or on the enclosed customer service list.

When calling, please state the product number (E-Nr.) and the production number (FD) which can be found on the rating plate.

→ *"Getting to know your appliance" on page 8*

Trust the expertise of the

manufacturer. You can therefore be sure that the repair is carried out by trained service technicians who carry original spare parts for your domestic appliances.

Appliance self-test

Your appliance features a self-test programme which displays the fault which your customer service can rectify.

1. Switch off the appliance and wait 5 minutes.
2. Switch on the appliance.
3. Within the first 10 seconds after switching on, press and hold the °C button for 3–5 seconds until 2 °C is lit on the temperature display refrigerator compartment. The self-test starts when the temperature displays are lit up in succession.

- If the set temperature is displayed again after the self-test has ended, your appliance is OK.
- If the **super** display flashes for 10 seconds, inform customer service.

When the programme has ended, the appliance switches over to normal operation.

Repair order and advice on faults

Contact information for all countries can be found on the enclosed customer service list.

GB	0344 892 8989	Calls charged at local or mobile rate.
IE	01450 2655	0.03 € per minute at peak. Off peak 0.0088 € per minute.

Guarantee

Detailed information on the warranty period and warranty conditions in your country are available from your customer service, your dealer and on our website.

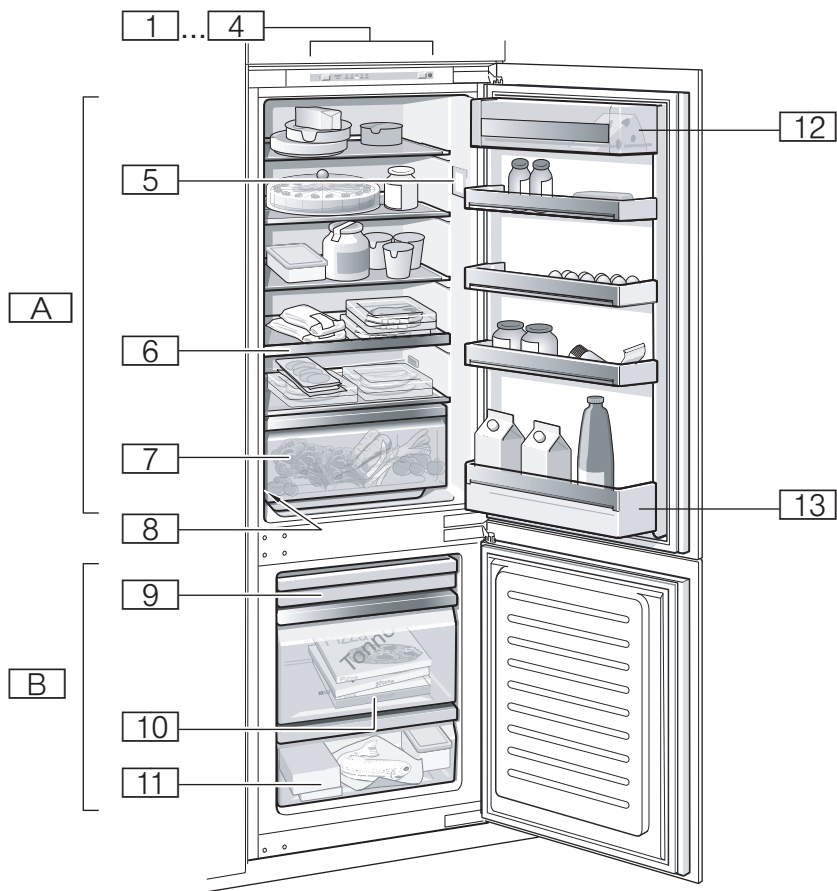

1

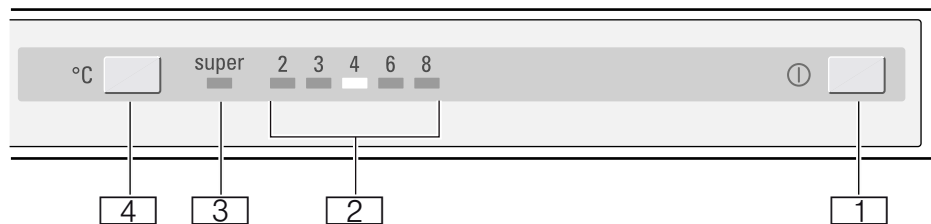

2



3



4



5



6

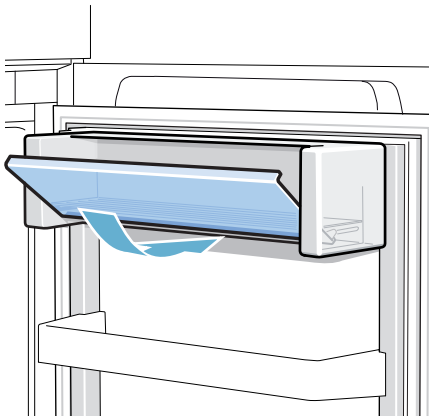

7

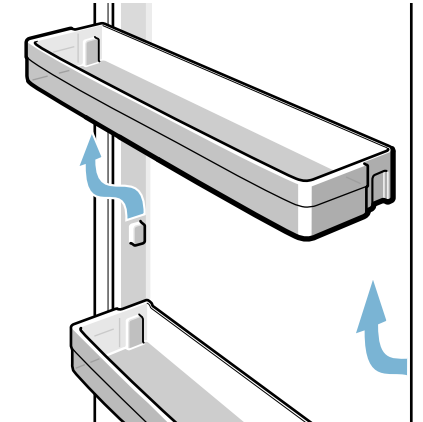

8

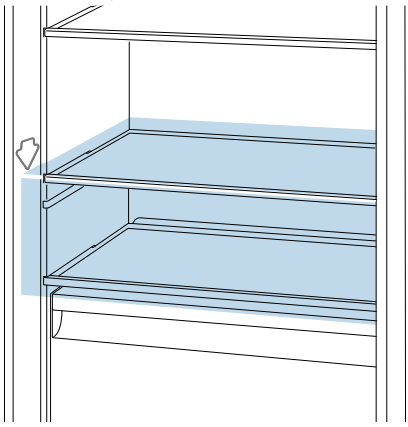

9



10



REGISTER YOUR PRODUCT
ONLINE NEFF-HOME.COM

Constructa NEFF Vertriebs-GmbH |
Carl-Wery-Straße 34 | 81739 Munich
Germany



9001080496
(9901)
en