

Extractor hood









Instruction manual

I91VT44N0, I91VT44N0B





## Table of contents

	<b>Important safety information</b> .....	<b>3</b>
	<b>Environmental protection</b> .....	<b>6</b>
	Saving energy .....	6
	Environmentally-friendly disposal .....	6
	<b>Operating modes</b> .....	<b>6</b>
	Exhaust air mode .....	6
	Air recirculation .....	6
	<b>Operating the appliance</b> .....	<b>7</b>
	Hob extractor system .....	7
	Controls .....	7
	Before using the appliance for the first time .....	8
	Switching the appliance on and off .....	8
	Intensive setting .....	8
	Run-on function .....	9
	Cooking with gas .....	9
	<b>Cleaning and maintenance</b> .....	<b>9</b>
	Saturation display .....	10
	Removing and installing the filter .....	10
	<b>Trouble shooting</b> .....	<b>13</b>
	Fault table .....	13
	<b>Customer service</b> .....	<b>13</b>
	<b>Accessories</b> .....	<b>14</b>

Additional information on products, accessories, replacement parts and services can be found at [www.neff-international.com](http://www.neff-international.com) and in the online shop [www.neff-eshop.com](http://www.neff-eshop.com)

## Important safety information

Read these instructions carefully. Only then will you be able to operate your appliance safely and correctly. Retain the instruction manual and installation instructions for future use or for subsequent owners.

The appliance can only be used safely if it is correctly installed according to the safety instructions. The installer is responsible for ensuring that the appliance works perfectly at its installation location.

This appliance is intended for domestic use and the household environment only. The appliance is not intended for use outside. Do not leave the appliance unattended during operation. The manufacturer is not liable for damage which is caused by improper use or incorrect operation.

This appliance is intended for use up to a maximum height of 2000 metres above sea level.

This appliance is not intended for use by persons (including children) with reduced physical, sensory or mental capabilities, or lack of experience and knowledge, unless they have been given supervision or instruction concerning use of the appliance by a person responsible for their safety.

Children must not play with, on, or around the appliance. Children must not clean the appliance or carry out general maintenance unless they are at least 8 years old and are being supervised.

Keep children below the age of 8 years old at a safe distance from the appliance and power cable.

Dangerous or explosive materials and vapours must not be extracted.

Check the appliance for damage after unpacking it. Do not connect the appliance if it has been damaged in transport.

This appliance is not intended for operation with an external clock timer or a remote control.

**⚠ Warning – Danger of suffocation!**

Packaging material is dangerous to children. Never allow children to play with packaging material.

**⚠ Warning – Danger of death!**

Risk of poisoning from flue gases that are drawn back in.

Always ensure adequate fresh air in the room if the appliance is being operated in exhaust air mode at the same time as room air-dependent heat-producing appliance is being operated.

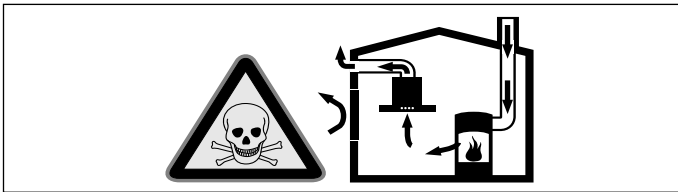

Room air-dependent heat-producing appliances (e.g. gas, oil, wood or coal-operated heaters, continuous flow heaters or water heaters) obtain combustion air from the room in which they are installed and discharge the exhaust gases into the open air through an exhaust gas system (e.g. a chimney). In combination with an activated vapour extractor hood, room air is extracted from the kitchen and neighbouring rooms - a partial vacuum is produced if not enough fresh air is supplied. Toxic gases from the chimney or the extraction shaft are sucked back into the living space.

- Adequate incoming air must therefore always be ensured.
- An incoming/exhaust air wall box alone will not ensure compliance with the limit.

Safe operation is possible only when the partial vacuum in the place where the heat-producing appliance is installed does not exceed 4 Pa (0.04 mbar). This can be achieved when the air needed for combustion is able to enter through openings that cannot be sealed, for example in doors, windows, incoming/exhaust air wall boxes or by other technical means.

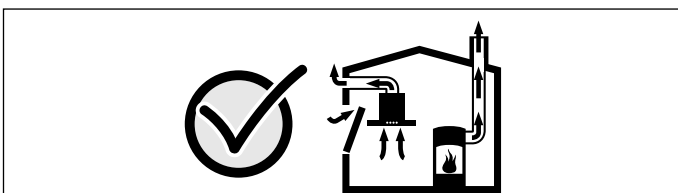

In any case, consult your responsible Master Chimney Sweep. He is able to assess the house's entire ventilation setup and will suggest the suitable ventilation measures to you.

Unrestricted operation is possible if the vapour extractor hood is operated exclusively in the circulating-air mode.

**⚠ Warning – Risk of fire!**

- Grease deposits in the grease filter may catch fire.

**Clean the grease filter at least every 2 months.**

Never operate the appliance without the grease filter.

- Grease deposits in the grease filter may catch fire. Never work with naked flames close to the appliance (e.g. flambéing). Do not install the appliance near a heat-producing appliance for solid fuel (e.g. wood or coal) unless a closed, non-removable cover is available. There must be no flying sparks.
- Hot oil and fat can ignite very quickly. Never leave hot fat or oil unattended. Never use water to put out burning oil or fat. Switch off the hotplate. Extinguish flames carefully using a lid, fire blanket or something similar.
- Fatty deposits in the grease filter may catch fire. If the appliance is to be operated next to a gas-fired appliance, a gas deflector must always be fitted before you begin cooking.

**Note:** The gas deflector reduces deflection/disruption of the gas flames from the burners on the cooktop and prevents them from being blown out by draughts.

- Fatty deposits in the grease filter may catch fire. Operating a gas wok gives rise to a great deal of heat. The appliance must not be combined with a gas wok.

**⚠ Warning – Risk of burns!**

The accessible parts become very hot when in operation. Never touch hot parts. Keep children at a safe distance.

**⚠ Warning – Risk of burns, risk of electric shock!**

from appliance. Always leave appliance to cool down before cleaning or servicing. Switch off fuse or pull out mains plug.

**⚠ Warning – Risk of burns!**

The appliance will become hot during operation. Allow it to cool down before touching the flaps and other components.

**⚠ Warning – Risk of injury!**

Components inside the appliance may have sharp edges. Wear protective gloves.

**⚠ Warning – Risk of electric shock!**

- A defective appliance may cause electric shock. Never switch on a defective appliance. Unplug the appliance from the mains or switch off the circuit breaker in the fuse box. Contact the after-sales service.
- Incorrect repairs are dangerous. Repairs may only be carried out and damaged power cables replaced by one of our trained after-sales technicians. If the appliance is defective, unplug the appliance from the mains or switch off the circuit breaker in the fuse box. Contact the after-sales service.
- Do not use any high-pressure cleaners or steam cleaners, which can result in an electric shock.

**⚠ Warning – Risk of electric shock!**

Penetrating moisture may result in an electric shock. Clean the appliance using a damp cloth only. Before cleaning, pull out the mains plug or switch off the circuit breaker in the fuse box.

**⚠ Warning – Electromagnetic hazards!**

- This appliance complies with safety and electromagnetic compatibility standards. However, people with pacemakers or insulin pumps must refrain from using this appliance. It is impossible to ensure that all of these devices available on the market comply with current electromagnetic compatibility standards, and that interference which may prevent the device from working correctly will not occur. It is also possible that people with other types of devices, such as a hearing aids, could experience some discomfort.
- The removable control element is magnetic and may affect electronic implants, e. g. heart pacemakers or insulin pumps. For people with electronic implants: never carry the control element in clothing pockets. The minimum distance to heart pacemaker should be 10 cm.

- The retractable control element is magnetic and may affect electronic implants, e.g. heart pacemakers or insulin pumps. For wearers of electronic implants: Do not stand right up against the appliance when you are making settings or cleaning.
- Permanent magnets are used in the control panel or in the control elements. They may affect electronic implants, e.g. heart pacemakers or insulin pumps. Wearers of electronic implants must stay at least 10 cm away from the control panel.

**⚠ Warning – Damage to the appliance!**

Small parts may damage the appliance if they fall into it.

**The appliance may only be operated if the metal grease filter has been inserted and the fan flaps have been fitted.**

**Causes of damage****Caution!**

Risk of damage due to corrosion. Always switch on the appliance while cooking to avoid condensation. Condensate can produce corrosion damage.

Risk of damage due to ingress of humidity into the electronic circuitry. Never clean operator controls with a wet cloth.

Surface damage due to incorrect cleaning. Clean stainless steel surfaces in the direction of the grain only. Do not use any stainless steel cleaners for operator controls.

Surface damage due to strong or abrasive cleaning agents. Never use strong and abrasive cleaning agents.

Risk of damage from returning condensate. Install the exhaust duct in such a way that it falls away from the appliance slightly (1° slope).

## Environmental protection

Your new appliance is particularly energy-efficient. Here you can find tips on how to save even more energy when using the appliance, and how to dispose of your appliance properly.

### Saving energy

- Only switch the ventilation on when necessary. You do not need to switch the ventilation on when cooking something for a short time that does not have a strong smell.
- Select a fan setting according to what you are cooking.
- Switch the ventilation off again after cooking.
- Cleaning the grease filter regularly will increase the efficiency of the ventilation.

### Environmentally-friendly disposal

Dispose of packaging in an environmentally-friendly manner.



This appliance is labelled in accordance with European Directive 2012/19/EU concerning used electrical and electronic appliances (waste electrical and electronic equipment - WEEE). The guideline determines the framework for the return and recycling of used appliances as applicable throughout the EU.

## Operating modes

### Exhaust air mode



The air which is drawn in is cleaned by the grease filters and conveyed to the exterior by a pipe system.

**Note:** The air must not be discharged into a flue that is used for exhausting fumes from appliances burning gas or other fuels (not applicable to appliances that only discharge the air back into the room).

- Before conveying the exhaust air into a non-functioning smoke or exhaust gas flue, obtain the consent of the heating engineer responsible.
- If the exhaust air is conveyed through the outer wall, a telescopic wall box should be used.

### Air recirculation



The air which is drawn in is cleaned by the grease filters and an activated carbon filter, and is conveyed back into the kitchen.

**Note:** To bind odours in air recirculation mode, you must install an activated carbon filter. The different options for operating the appliance in air recirculation mode can be found in the brochure. Alternatively, ask your dealer. The required accessories are available from specialist retailers, from customer service or from the Online Shop.

## Operating the appliance

### Warning – Risk of burns!

The appliance will become hot during operation. Allow it to cool down before touching the fan flaps and other components.

**Note:** Switch on the extractor hood when you start cooking and switch it off again several minutes after you have finished cooking. This is the most effective way of removing the kitchen fumes.

### Hob extractor system

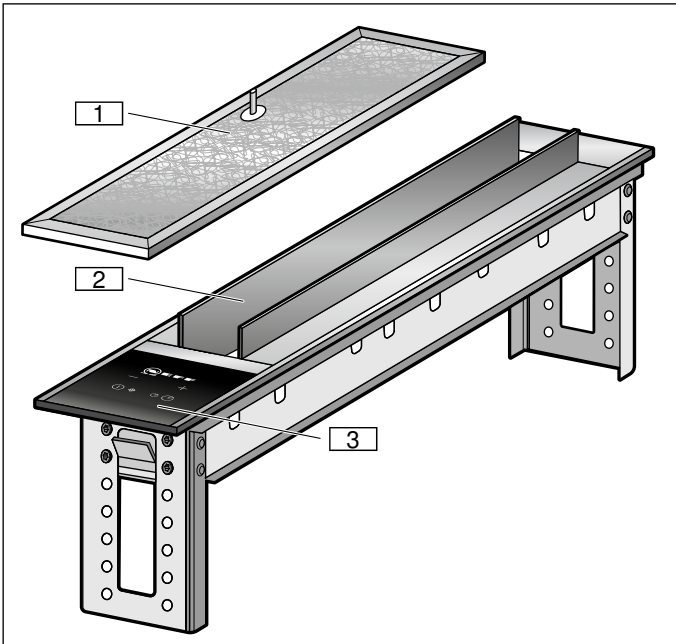



- 1** Metal grease filter
- 2** Fan flaps
- 3** Control panel

## Controls



### Control panel



### Operating buttons

Button	Explanation
	Switches the extractor hood on and off
	Switches on the run-on function
-	Reduces the power level/resets the metal grease filter and activated charcoal filter saturation indicators
+	Increases the power level

### Indicators/symbols

Indicator/symbol	Explanation
	Run-on function
	Metal grease filter saturation indicator
	Activated charcoal filter saturation indicator
<b>1</b>	Power level 1
<b>2</b>	Power level 2
<b>3</b>	Power level 3
<b>P</b>	Intensive mode

## Before using the appliance for the first time

Before you can use your new appliance, you must apply certain settings.

Follow the instructions below before using the appliance for the first time:

### Notes

- Thoroughly clean the appliance and accessories.
- If your hob is a gas hob, fit the gas deflector to the appliance. To do this, refer to the printed supplement.

### Initial use

#### Switching over the display for circulating-air mode

For circulating-air mode, the electronic controller indicator must be switched over accordingly:

1. Check whether the extractor hood is connected and switched off.
2. Press and hold the **+** button until  flashes twice on the display panel.  
This will switch the electronic controller over to circulating-air mode.

#### Switching over the display for exhaust air mode

1. Check whether the extractor hood is connected and switched off.
2. Press and hold the **+** button until  flashes once on the display panel.  
This will switch the electronic controller over to air extraction mode.

## Switching the appliance on and off

**Note:** Before you switch on the appliance, open both fan flaps by pressing on them lightly.

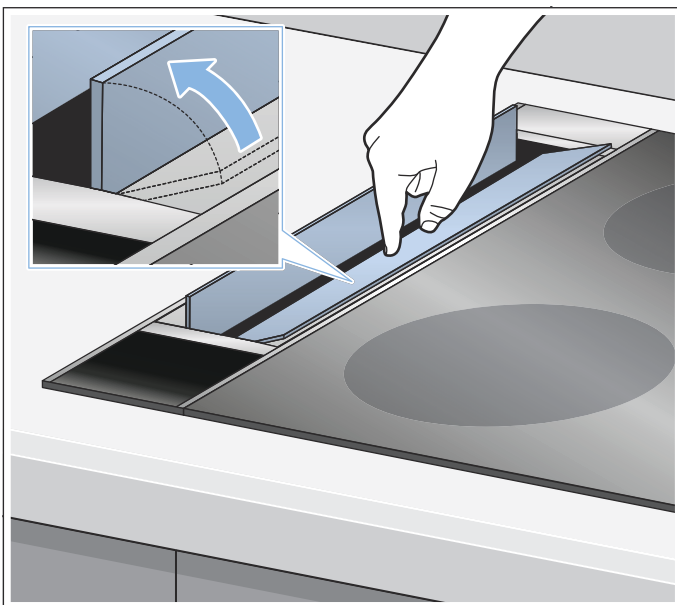

**Note:** Always adjust the setting according to the current conditions. To eliminate strong cooking smells, select a high fan setting.

**Note:** When using pans for cooking, use the appropriate pan lid. If necessary, place the lid on the pan at a slight angle, with the gap facing the worktop-mounted ventilation system. This improves the extraction behaviour of the table ventilation.

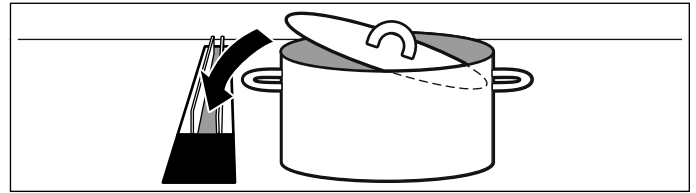

### Switching on the appliance

Press the  button.

The extractor hood starts at fan setting 1.

The fan setting that is selected will be shown on the display panel.

### Selecting the fan setting

Press the **+** or **-** button to set the corresponding fan setting.

The fan setting that is selected will be shown on the display panel.

### Switching off the appliance

Press the  button.

### Intensive setting

Activate intensive mode to eliminate strong smells and odours. In this mode, the extractor hood operates at its maximum fan setting for a short time. After a short time, it automatically switches back to a low setting.

### Switching on

Press and hold the **+** button until  appears on the display panel.

Intensive mode is now activated.

**Note:** After 6 minutes, the extractor hood automatically switches back to the fan setting that was set beforehand.

### Switching off

Press the **-** button to set a different fan setting.





## Run-on function

The run-on function allows the table ventilation to continue running for a few minutes after it has been switched off. This eliminates any remaining cooking smells. The run-on prevents moisture from collecting in the table ventilation and in the air recirculation in the cabinet and toe kick. The table ventilation then switches itself off automatically.

## Switching on

### Notes

- If intensive mode has been activated, the run-on function is not available.
- The fan flaps must remain closed while the run-on function is active.

1. Select the fan setting.
2. Press the  button.  
The  indicator will light up. The fan will continue to run at this setting for 15 minutes and then switch off automatically once this time has elapsed.

## Switching off

Press the  or  button.

This will deactivate the run-on function immediately.

## Cooking with gas

### Warning – Risk of fire!

Fatty deposits in the grease filter may catch fire. If the appliance is to be operated next to a gas-fired appliance, a gas deflector must always be fitted before you begin cooking.

**Note:** The gas deflector reduces deflection/disruption of the gas flames from the burners on the cooktop and prevents them from being blown out by draughts.

### Warning – Risk of burns!

The appliance will become hot during operation. Allow it to cool down before touching the fan flaps, gas deflector and other components.

**Note:** When the gas deflector is fitted, select intensive mode or setting 3. This improves the extraction performance of the worktop-mounted ventilation system.

**Note:** When using pans for cooking, use the appropriate pan lid. If necessary, place the lid on the pan at a slight angle, with the gap facing the worktop-mounted ventilation system. This improves the extraction behaviour of the table ventilation.

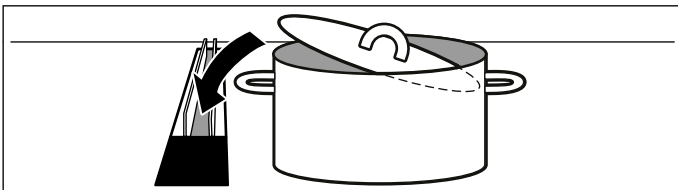

## Cleaning and maintenance

### Warning – Risk of burns!

The appliance becomes hot during operation. Allow the appliance to cool down before cleaning.

### Warning – Risk of electric shock!

Penetrating moisture may result in an electric shock. Clean the appliance using a damp cloth only. Before cleaning, pull out the mains plug or switch off the circuit breaker in the fuse box.

### Warning – Risk of electric shock!

Do not use any high-pressure cleaners or steam cleaners, which can result in an electric shock.

### Warning – Risk of injury!

Components inside the appliance may have sharp edges. Wear protective gloves.

## Cleaning agents

To ensure that the different surfaces are not damaged by using the wrong cleaning agent, observe the information in the table. Do not use any of the following:

- Harsh or abrasive cleaning agents,
- Cleaning agents with a high alcohol content,
- Hard scouring pads or cleaning sponges,
- High-pressure cleaners or steam cleaners.

Wash new sponge cloths thoroughly before use.

Follow all instructions and warnings included with the cleaning agents.

Area	Cleaning agent
Stainless steel	Hot soapy water: Clean with a dish cloth and then dry with a soft cloth. Clean stainless steel surfaces in the grind direction only. Special stainless steel cleaning products are available from our after-sales service or from specialist retailers. Apply a very thin layer of the cleaning product with a soft cloth.
Painted surfaces	Hot soapy water: Clean using a damp dish cloth and dry with a soft cloth/towel. Do not use any stainless steel cleaners.
Aluminium and plastic	Glass cleaner: Clean with a soft cloth.

Area	Cleaning agent
Glass	Glass cleaner: Clean with a soft cloth. Do not use a glass scraper.
Controls	Hot soapy water: Clean using a damp dish cloth and dry with a soft cloth/towel.  Risk of electric shock caused by penetrating moisture.  Risk of damage to the electronics from penetrating moisture. Never clean operating controls with a wet cloth.  Do not use any stainless steel cleaners.

### Saturation display

When the metal grease filters or activated charcoal filters are saturated, the corresponding symbol will light up:

- **Metal grease filter:** 
- **Activated charcoal filter:**  and 
- **Metal grease filter and activated charcoal filter:**  and 

Do not wait any longer to clean the metal grease filters or replace or regenerate the activated charcoal filters.

### Removing and installing the filter

The filter must be serviced regularly in order to guarantee efficient filtration of odours and grease.

#### Metal grease filter

The metal grease filters must be cleaned when the display lights up or at least every two months.

#### **Warning – Risk of fire!**

Grease deposits in the grease filter may catch fire.

**Clean the grease filter at least every 2 months.**

Never operate the appliance without the grease filter.

#### **Warning – Damage to the appliance!**

Small parts may damage the appliance if they fall into it.

**The appliance may only be operated if the metal grease filter has been inserted and the fan flaps have been fitted.**

#### **Activated charcoal filter (only in circulating-air mode)**

The activated charcoal filters must be replaced or regenerated regularly. The saturation indicator on your appliance will tell you how frequently this needs to be done.

### Removing metal grease filter

The metal grease filters filter the grease out of kitchen steam. To keep them in good working order, the filters should be cleaned at least every two months.

1. Open the fan flaps.

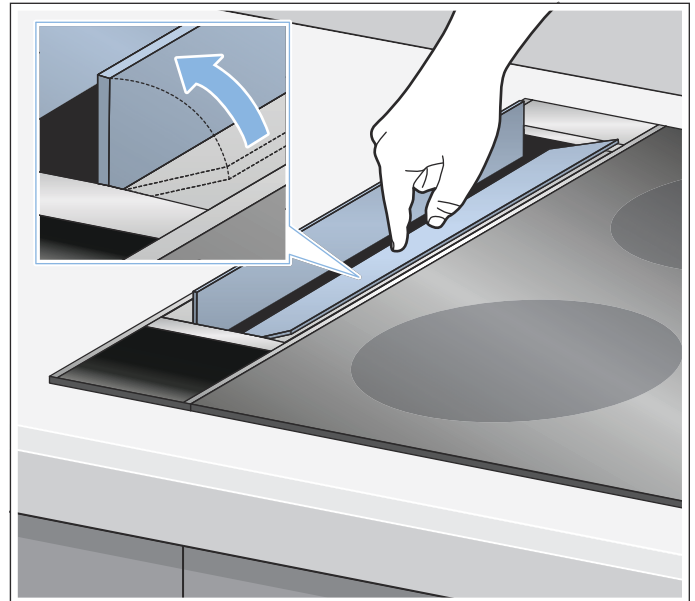

2. Take hold of the metal grease filter with two fingers at its edge and remove it.

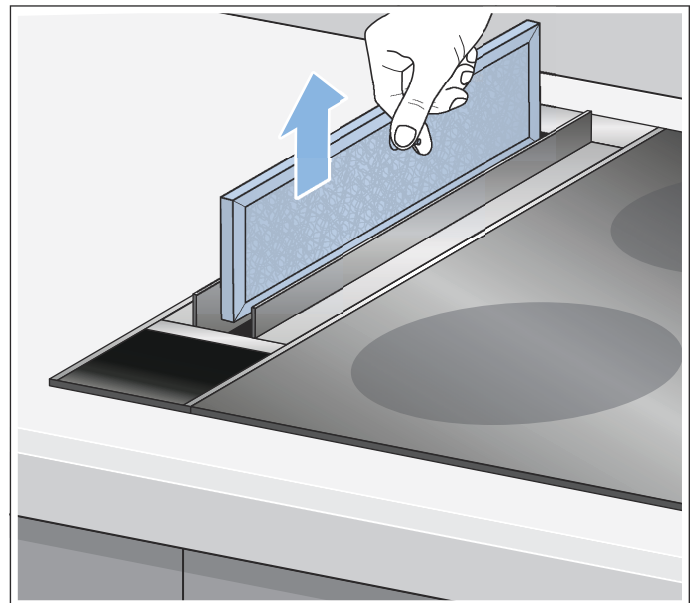

#### **Caution!**

Risk of damage when lifting out and setting down the fan flaps. Pull the metal grease filter straight up to remove it and make sure that you do not scratch the surfaces of the appliance.

3. Clean the metal grease filter and filter cover.

**Cleaning the inside of the appliance**

You can remove the fan flaps in order to clean the appliance thoroughly.

1. Open the fan flaps.

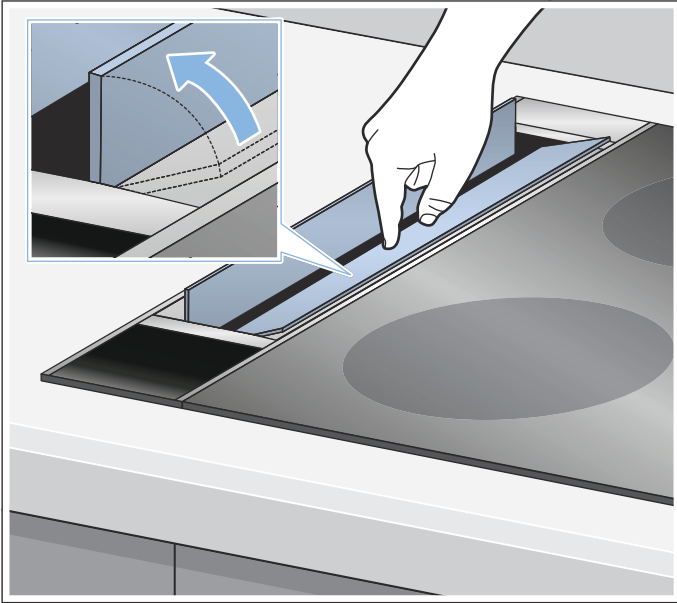

2. Remove the magnetic strips from the ends of the fan flaps.

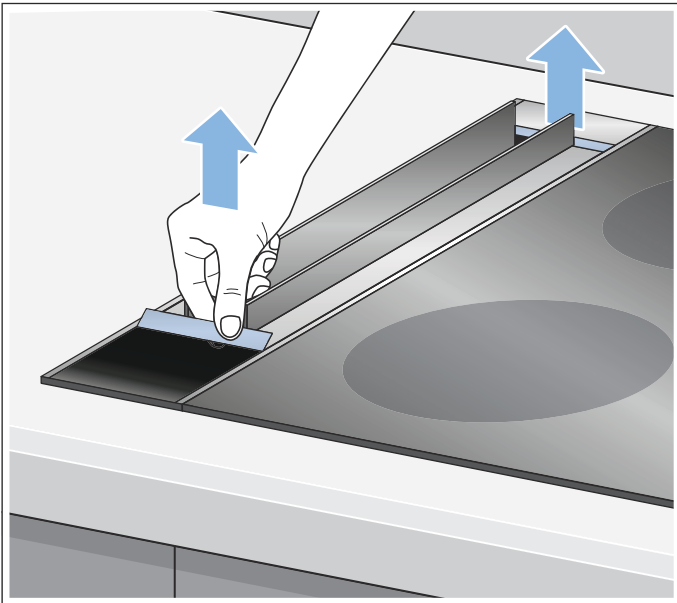

3. Pull up each of the fan flaps individually to remove them.

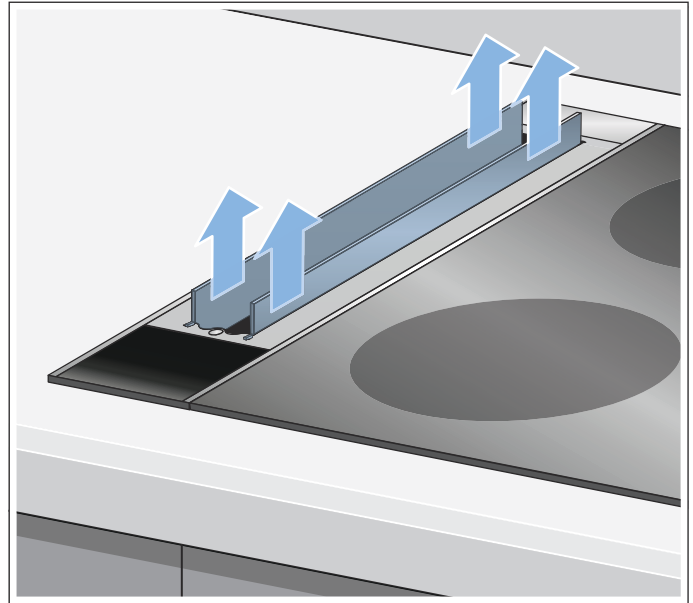
**Caution!**

Risk of damage when lifting out and setting down the fan flaps. Pull the fan flaps up to remove them and make sure that you do not scratch the surfaces of the appliance.

4. Once the fan flaps and filter have been removed, clean the inside of the appliance.
5. Once you have finished cleaning the appliance, insert the metal grease filter and refit the fan flaps and the magnetic strips.

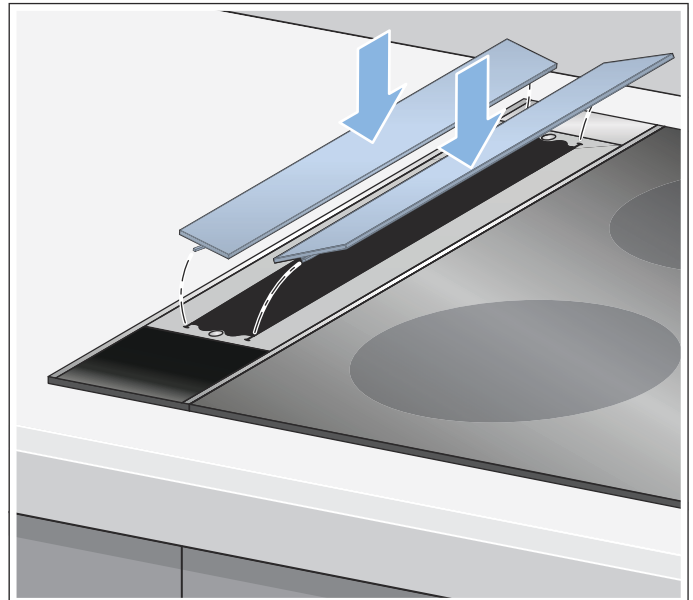

## Cleaning the metal mesh grease filters

### Notes

- Do not use any aggressive, acidic or alkaline cleaning agents.
- When cleaning the metal mesh grease filters, also clean the holder for the metal mesh grease filters in the appliance using a damp cloth.
- The metal mesh grease filters can be cleaned in the dishwasher or by hand.

### By hand:

**Note:** You can use a special grease solvent for stubborn dirt. It can be ordered via the Online Shop.

- Soak the metal mesh grease filters in a hot soapy solution.
- Clean the filters with a brush and then rinse them thoroughly.
- Leave the metal mesh grease filters to drain.

### In the dishwasher:

**Note:** Slight discolouration may occur if the metal grease filters are cleaned in the dishwasher. This has no effect on the performance of the metal grease filters.

- Do not clean heavily soiled metal grease filters together with cookware.
- Place the metal grease filters in the dishwasher, leaving plenty of space around them. The metal grease filters must not be wedged in.
- Place the metal grease filters in the dishwasher with the opening facing down.
- Wash the fan flaps and gas deflector by hand, and not in the dishwasher.

## Installing the metal mesh grease filter

Position the metal grease filter correctly and insert it.

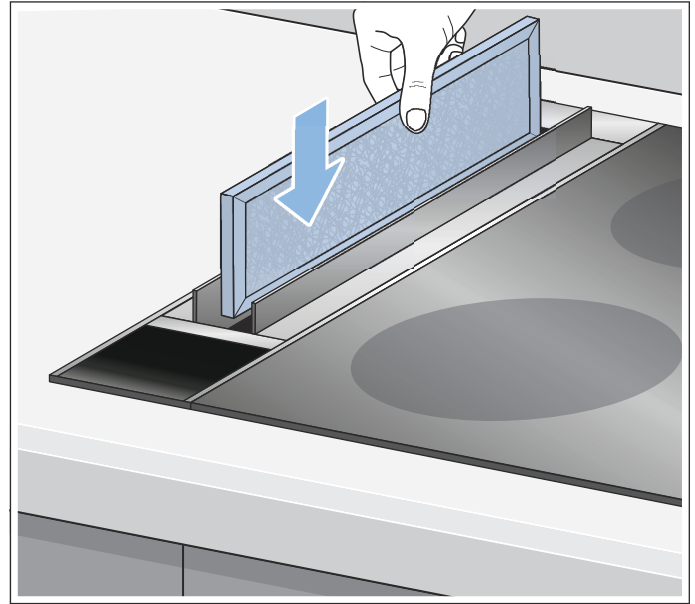

**Note:** Place the filter into the groove.

## Replacing or regenerating the activated charcoal filters

Activated charcoal filters trap the odour-causing compounds in cooking smells. They are only used for circulating-air mode.

### Notes

- The air recirculation module and activated charcoal filters are not included with the appliance. The air recirculation module and activated charcoal filters are available from specialist retailers, from our after-sales service or from our online shop.
- Only use genuine replacement filters. This will ensure that the appliance performs optimally.
- Refer to the printed supplement for information about the regenerability of the activated charcoal filters and about replacing them.

## Resetting the saturation displays

Once you have cleaned or replaced the relevant filters, reset the saturation indicator so that the symbols go out.

Press and hold the **—** button until **8** flashes three times on the display panel. The saturation indicators for the metal grease filter and the activated charcoal filter have now been reset.

## Trouble shooting

Malfunctions often have simple explanations. Please read the following notes before calling the after-sales service.

### **Warning – Risk of electric shock!**

Incorrect repairs are dangerous. Repairs may only be carried out and damaged power cables replaced by one of our trained after-sales technicians. If the appliance is defective, unplug the appliance from the mains or switch off the circuit breaker in the fuse box. Contact the after-sales service.

### Fault table

Problem	Possible cause	Solution
The appliance does not work	The plug is not plugged into the mains	Connect the appliance to the power supply
	Power cut	Check whether other kitchen appliances are working
	The fuse is faulty	Check in the fuse box to make sure that the fuse for the appliance is in working order
The button illumination does not work.	The control unit is faulty.	Call the after-sales service.
Appliance is making noises	All the fan flaps are closed	Open all the fan flaps
The grease filter/activated charcoal filter indicator is lit.	The grease filter/activated charcoal filter is saturated.	Clean the filter. → "Cleaning and maintenance" on page 9
Liquid in the appliance	Liquid has found its way into the fan opening	Switch on the appliance and leave it running at setting 1 for approx. 30 minutes. Cleaning the inside of the appliance → Page 11

## Customer service

When calling us, please quote the product number (E no.) and the production number (FD no.) so that we can provide you with the correct advice. The rating plate bearing these numbers can be found on the fan module.

You can make a note of the numbers of your appliance and the telephone number of the after-sales service in the space below to save time should it be required.

E no.	FD no.
<b>After-sales service</b> 	

Please be aware that a visit by an after-sales engineer will be charged if a problem turns out to be the result of operator error, even during the warranty period.

Please find the contact data of all countries in the enclosed customer service list.

### To book an engineer visit and product advice

**GB** 0344 892 8989  
Calls charged at local or mobile rate.

**IE** 01450 2655  
0.03 € per minute at peak. Off peak 0.0088 € per minute.

Rely on the professionalism of the manufacturer. You can therefore be sure that the repair is carried out by trained service technicians who carry original spare parts for your appliances.

## Accessories

### Special accessories

Accessories	Order number
Air recirculation module for I91VT44N0	Z5290X0

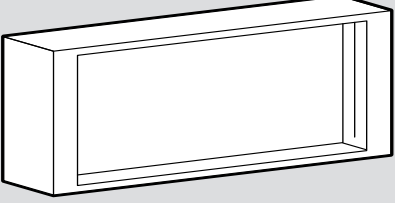

A technical line drawing of a rectangular air recirculation module. It features a front panel with a central rectangular opening and a slightly recessed top edge. The drawing is shown from a three-quarter perspective against a light gray background.

Accessories	Order number
Gas deflector for I91VT44N0	Z52VA10X0

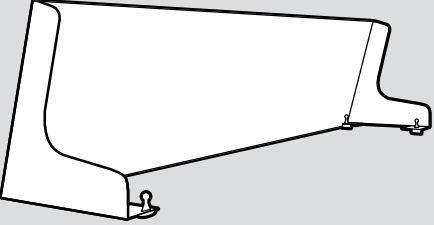

A technical line drawing of a gas deflector. It is a long, thin, curved metal piece with a flat top surface and a vertical lip on one side. Two small mounting brackets are attached to the bottom edge. The drawing is shown from a three-quarter perspective against a light gray background.



Constructa Neff  
Vertriebs-GmbH  
Carl-Wery-Straße 34  
D-81739 München

Register your product online

[www.neff-international.com](http://www.neff-international.com)



9001182403  
970208  
en