



## CEILING VENTILATION







[en] Instructions for installation and use













# en Table of contents

INSTRUCTION MANUAL .....	3
 Intended use .....	3
 Important safety information .....	4
 Environmental protection.....	6
 Operating modes.....	7
 Operating the appliance .....	7
 Connecting to a hob .....	10
 Home Connect.....	11

 Cleaning and maintenance.....	13
 Trouble shooting.....	15
 Customer service .....	16
INSTALLATION INSTRUCTIONS.....	17
 Important safety information .....	18
 General information .....	20
 Installation .....	21

## INSTRUCTION MANUAL

Additional information on products, accessories, replacement parts and services can be found at [www.neff-international.com](http://www.neff-international.com) and in the online shop [www.neff-eshop.com](http://www.neff-eshop.com)

### Intended use

Read these instructions carefully. Only then will you be able to operate your appliance safely and correctly. Retain the instruction manual and installation instructions for future use or for subsequent owners.

The appliance can only be used safely if it is correctly installed according to the safety instructions. The installer is responsible for ensuring that the appliance works perfectly at its installation location.

This appliance is intended for domestic use and the household environment only. The appliance is not intended for use outside. Do not leave the appliance unattended during operation. The manufacturer is not liable for damage which is caused by improper use or incorrect operation.

This appliance is intended for use up to a maximum height of 2000 metres above sea level.

This appliance may be used by children over the age of 8 years old and by persons with reduced physical, sensory or mental capacity or by persons with a lack of experience or knowledge if they are supervised by someone who is responsible for their safety, or have been instructed in how to use the appliance safely and have understood the risks involved in not using it properly.

Children must not play with the appliance. Cleaning and user maintenance must not be performed by children unless they are over 15 years of age and are supervised.

Keep children below the age of 8 years old at a safe distance from the appliance and power cable.

Check the appliance for damage after unpacking it. Do not connect the appliance if it has been damaged in transport.

This appliance is not intended for operation with an external clock timer or a remote control.

## Important safety information

### Warning – Danger of suffocation!

Packaging material is dangerous to children. Never allow children to play with packaging material.

### Warning – Danger of death!

Risk of poisoning from flue gases that are drawn back in.

Always ensure adequate fresh air in the room if the appliance is being operated in exhaust air mode at the same time as room air-dependent heat-producing appliance is being operated.

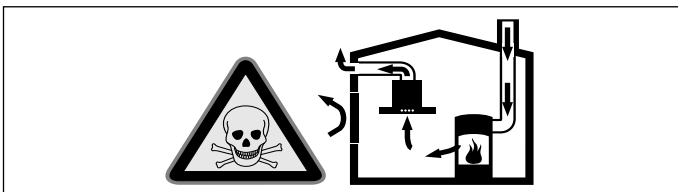

Room air-dependent heat-producing appliances (e.g. gas, oil, wood or coal-operated heaters, continuous flow heaters or water heaters) obtain combustion air from the room in which they are installed and discharge the exhaust gases into the open air through an exhaust gas system (e.g. a chimney).

In combination with an activated vapour extractor hood, room air is extracted from the kitchen and neighbouring rooms - a partial vacuum is produced if not enough fresh air is supplied. Toxic gases from the chimney or the extraction shaft are sucked back into the living space.

- Adequate incoming air must therefore always be ensured.
- An incoming/exhaust air wall box alone will not ensure compliance with the limit.

Safe operation is possible only when the partial vacuum in the place where the heat-producing appliance is installed does not exceed 4 Pa (0.04 mbar). This can be achieved when the air needed for combustion is able to enter through openings that cannot be sealed, for example in doors, windows, incoming/exhaust air wall boxes or by other technical means.

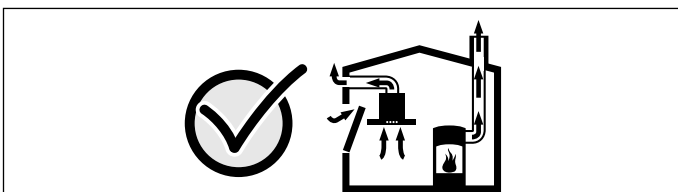

In any case, consult your responsible Master Chimney Sweep. He is able to assess the house's entire ventilation setup and will suggest the suitable ventilation measures to you.

Unrestricted operation is possible if the vapour extractor hood is operated exclusively in the circulating-air mode.

### Warning – Risk of fire!

- Fatty deposits in the grease filter may catch fire. Regularly clean the grease filter. Never operate the appliance without a grease filter.
- Grease deposits in the grease filter may catch fire. Never work with naked flames close to the appliance (e.g. flambéing). Do not install the appliance near a heat-producing appliance for solid fuel (e.g. wood or coal) unless a closed, non-removable cover is available. There must be no flying sparks.
- Hot oil and fat can ignite very quickly. Never leave hot fat or oil unattended. Never use water to put out burning oil or fat. Switch off the hotplate. Extinguish flames carefully using a lid, fire blanket or something similar.
- When gas burners are in operation without any cookware placed on them, they can build up a lot of heat. A ventilation appliance installed above the cooker may become damaged or catch fire. Only operate the gas burners with cookware on them.
- Operating several gas burners at the same time gives rise to a great deal of heat. A ventilation appliance installed above the cooker may become damaged or catch fire. Never operate two gas burners simultaneously on the highest flame for longer than 15 minutes. One large burner of more than 5 kW (wok) is equivalent to the power of two gas burners.

### Warning – Risk of burns!

- The accessible parts become very hot when in operation. Never touch hot parts. Keep children at a safe distance.
- The appliance will become hot during operation, especially near the bulbs. Allow the appliance to cool down before cleaning.

**⚠ Warning – Risk of injury!**

- Components inside the appliance may have sharp edges. Wear protective gloves.
- The appliance may fall down if it has not been properly fastened in place. All fastening components must be fixed firmly and securely.
- The appliance is heavy. To move the appliance, 2 people are required. Use only suitable tools and equipment.
- The appliance is very heavy. The appliance must not be fitted directly onto plasterboard or similar lightweight materials. To ensure correct installation, you must use a material which is sufficiently stable and suitable for both the structural conditions and the weight of the appliance.
- Changes to the electrical or mechanical assembly are dangerous and may lead to malfunctions. Do not make any changes to the electrical or mechanical assembly.
- The filter cover may swing out. Always open and close the filter cover slowly. Ensure that the filter cover does not swing out after it is released.
- Risk of trapping body parts when opening and closing the filter cover. Do not reach into the area behind the filter cover and keep your hands away from the hinges.
- Batteries can be easily swallowed by children. Keep batteries out of the reach of children. Do not allow children to change batteries without supervision.
- Batteries may explode. Do not charge or short-circuit the batteries. Do not throw batteries into a fire.
- The connection terminals must not be short circuited.
- Only batteries of the specified type may be used. Different types of batteries or old and new batteries must not be mixed together.
- Rechargeable batteries must not be used.
- Use a stable ladder and make sure it is in a secure position. Do not lean over the hob and do not step on the work surface or the hob.

- Risk of falling when working on the appliance. Use a stable stepladder.
- Before cleaning the appliance, disconnect it from the Home Connect app to ensure that operation via the Home Connect app is not possible.

**⚠ Warning – Risk of electric shock!**

- A defective appliance may cause electric shock. Never switch on a defective appliance. Unplug the appliance from the mains or switch off the circuit breaker in the fuse box. Contact the after-sales service.
- Incorrect repairs are dangerous. Repairs may only be carried out and damaged power cables replaced by one of our trained after-sales technicians. If the appliance is defective, unplug the appliance from the mains or switch off the circuit breaker in the fuse box. Contact the after-sales service.
- Penetrating moisture may result in an electric shock. Clean the appliance using a damp cloth only. Before cleaning, pull out the mains plug or switch off the circuit breaker in the fuse box.
- Do not use any high-pressure cleaners or steam cleaners, which can result in an electric shock.

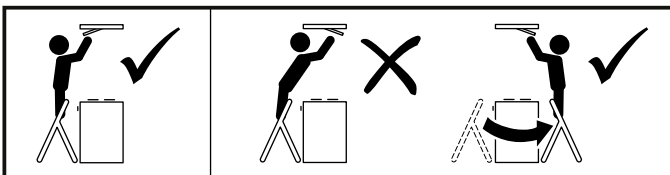

## Causes of damage

### Caution!

Risk of damage due to corrosion. Always switch on the appliance while cooking to avoid condensation. Condensate can produce corrosion damage.

Always replace faulty bulbs to prevent the remaining bulbs from overloading.

Risk of damage due to ingress of humidity into the electronic circuitry. Never clean operator controls with a wet cloth.

Surface damage due to incorrect cleaning. Clean stainless steel surfaces in the direction of the grain only. Do not use any stainless steel cleaners for operator controls.

Surface damage due to strong or abrasive cleaning agents. Never use strong and abrasive cleaning agents.

Risk of damage as a result of incorrect loading of design elements. Do not pull design elements. Do not place objects on the design elements or hang objects from them.

### Caution!

Damage to the remote control caused by leaking batteries. Remove the batteries in the remote control if the remote control is not being used over a longer period of time.

### Caution!

Remove batteries that are flat or defective from the remote control and dispose of them safely in accordance with local regulations. Do not dispose of batteries alongside general household waste.

## Environmental protection

Your new appliance is particularly energy-efficient. Here you can find tips on how to save even more energy when using the appliance, and how to dispose of your appliance properly.

### Saving energy

- During cooking, ensure that there is a sufficient supply of air to enable the extractor hood to work efficiently and with a low level of operating noise.
- Adjust the fan speed to the amount of steam produced during cooking. Only use intensive mode when required. The lower the fan speed, the less energy is consumed.
- If cooking produces large amounts of steam, select a higher fan speed in good time. If the cooking steam has already spread around the kitchen, the extractor hood will need to be operated for longer.
- Switch off the extractor hood if you no longer require it.
- Switch off the lighting if you no longer require it.
- Clean and (if required) replace the filter at regular intervals in order to increase the effectiveness of the ventilation system and to prevent the risk of fire.
- Put the lid on to reduce cooking steam and condensation.

### Environmentally-friendly disposal

Dispose of packaging in an environmentally-friendly manner.



This appliance is labelled in accordance with European Directive 2012/19/EU concerning used electrical and electronic appliances (waste electrical and electronic equipment - WEEE). The guideline determines the framework for the return and recycling of used appliances as applicable throughout the EU.

### Disposing of batteries

Dispose of used batteries in an environmentally friendly manner.



Batteries must not be disposed of in the household waste after use. Consumers are obliged by law to return all used batteries to a retailer or other collection points. The retailer is obliged to take back used batteries free of charge.

## Operating modes

### Exhaust air mode



The air which is drawn in is cleaned by the grease filters and conveyed to the exterior by a pipe system.

**Note:** The exhaust air must not be conveyed into a functioning smoke or exhaust gas flue or into a shaft which is used to ventilate installation rooms which contain heat-producing appliances.

- Before conveying the exhaust air into a non-functioning smoke or exhaust gas flue, obtain the consent of the heating engineer responsible.
- If the exhaust air is conveyed through the outer wall, a telescopic wall box should be used.

### Circulating-air mode



The air which is drawn in is cleaned by the grease filters and an activated carbon filter and conveyed back into the kitchen.

**Note:** To bind odours in circulating-air mode, you must install an activated carbon filter. The different options for operating the appliance in circulating-air mode can be found in the brochure. Alternatively, ask your dealer. The required accessories are available from specialist retailers, from customer service or from the Online Shop.

## Operating the appliance

These instructions apply to several appliance variants. It is possible that individual features are described which do not apply to your appliance.

If your appliance has Home Connect, more functions are only available in the Home Connect app.









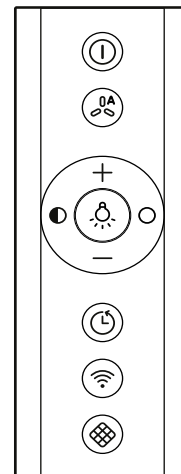

**Note:** Switch on the extractor hood when you start cooking and switch it off again several minutes after you have finished cooking. This is the most effective way of removing the kitchen fumes.

### Remote control

Use the remote control to set and adjust the various different functions of your appliance.

**Note:** Align the remote control as precisely as possible to the infrared receiver for the LED display.



Symbol	Explanation
	On/Off
	Automatic mode/climateControl sensor
	Light on/off
	Reducing the brightness
	Increasing the brightness
	Increasing the fan setting
	Decreasing the fan setting
	Fan run-on
	Home Connect
	Resetting filter saturation



## LED display

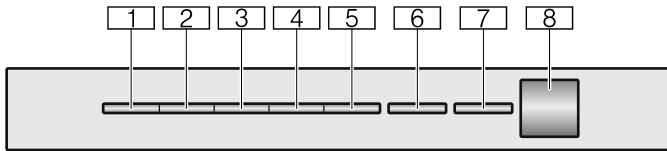

LED	Explanation
1	Fan setting 1
2	Fan setting 2
3	Fan setting 3
4	Intensive mode 1
5	Intensive mode 2
6	Automatic mode / fan run-on time / interval ventilation
7	Home Connect
8	Infrared receiver

## Setting the fan

### Switching on

1. Press the button.  
The fan starts at fan setting 2.
2. Press the **+** or **-** button to set a different fan setting.  
The corresponding LEDs light up on the appliance.

**Note:** The appliance has 3 fan settings and 2 intensive modes.

### Switching off

Press the button.

## Intensive setting

You can use the intensive setting if there is a large build-up of odours and fumes/vapours.

### Switching on

1. Press the button.  
The fan starts at fan setting 2.
2. Press the **+** button twice in order to set intensive mode 1.
3. Press the **+** button three times in order to set intensive mode 2.  
The corresponding LEDs light up on the appliance.

**Note:** After approx. 6 minutes, the extractor hood automatically switches back to fan setting 3.

## Fan run-on time

### Switching on

Press the button.

The fan runs at fan setting 1. LED 1 on the appliance lights up, LED 6 flashes.

After approx. 10 minutes, the fan switches off automatically.

### Switching off

Press the button.

This immediately stops the fan run-on.

## Intermittent ventilation

This function is only available in the Home Connect app.

With interval ventilation, the ventilation system switches on and off in the selected setting for the selected time.

LED 6 flashes continuously, the LED for the selected ventilation setting lights up on the appliance.

As soon as the ventilation duration comes to an end, the LED for the ventilation setting you have selected goes out. LED 6 continues to flash.

## Automatic mode

### Switching on

1. Press the button.  
The fan starts at fan setting 2. The corresponding LEDs light up.
2. Press the button.  
LED 6 on the appliance lights up and the optimum fan setting is set automatically via a sensor.

### Switching off

Switch off automatic mode using the button.

The fan switches itself off automatically if the sensor detects no further change in the air quality of the room.

Automatic mode can run for a maximum of four hours.

## Sensor control

In automatic mode, a sensor in the extractor hood detects the intensity of the cooking and roasting odours. Depending on the sensor setting, the fan automatically switches itself to another fan setting.

Possible sensor settings:

Default sensitivity setting: LED 3 (fan setting 3)

Lowest sensitivity setting: LED 1 (fan setting 1)

Highest sensitivity setting: LED 5 (intensive mode 2)

If the sensor control responds too strongly or not enough, it can be changed accordingly:

1. When the appliance is switched off, press and hold the and buttons for approx. 3 seconds.
2. Press the **+** or **-** button to change the sensor control setting.
3. Press and hold the and buttons for approx. 3 seconds to save the setting or wait for approx. 10 seconds until the setting is automatically saved.  
A signal tone will sound.

**Note:** Press the button to cancel the setting.



## Saturation display

When the metal grease filters or the air recirculation filter are saturated after the appliance has been switched off, the corresponding symbols flash and a repeated signal tone sounds:





- **Metal grease filter:** LED 1 flashes
- **Air recirculation filter:** LED 2 flashes
- **Metal grease filter and air recirculation filter:** LEDs 1 and 2 flash

If you have not yet done so, the metal grease filters should now be cleaned or the air recirculation filter replaced. → *"Cleaning and maintenance" on page 13*

The saturation indicators can be reset while they are flashing. To do this, press the  button.

### Switching over to circulating-air mode

For circulating-air mode, the electronic controller must be switched over accordingly.

1. When the appliance is switched off, press and hold the  and  buttons for approx. 3 seconds. The LED for the currently active filter setting lights up on the appliance.
2. Press the **+** button/**-** button until LED 2 for circulating-air mode (filter cannot be regenerated) lights up on the appliance.
3. Press the **+** button/**-** button until LED 3 for circulating-air mode (filter can be regenerated) lights up on the appliance.
4. Press the **+** button/**-** button until LED 1 on the appliance for the electronic controller is switched back to operation without air recirculation filter.
5. Press and hold the  and  buttons for approx. 3 seconds to save the setting or wait for approx. 10 seconds until the setting is automatically saved. A signal tone will sound.



**Note:** Press the  button to cancel the setting.

## Lighting

The lighting can be switched on and off independently of the fan.

Press the  button.

### Setting the brightness



Press and hold the  or  button until the required brightness is reached.

**Note:** Colour temperature settings are available in the Home Connect app provided the appliance has this function.

## Button tone

### Switching on or off

**Note:** Only button tones can be switched on and off. Signal tones on the appliance cannot be switched off.

1. When the appliance is switched off, press and hold the  and **-** buttons for approx. 3 seconds. The LED in the currently selected setting lights up.
2. Press the **+** or **-** button to change the setting. The button tones are switched on if LED 1 lights up on the appliance. The button tones are switched off if LED 2 lights up on the appliance.
3. Press and hold the  and **-** buttons for approx. 3 seconds to save the setting or wait for approx. 10 seconds until the setting is automatically saved. A signal tone will sound.

**Note:** Press the  button to cancel the setting.

## Connecting to a hob

You can connect this appliance to a hob (if the hob supports connection to the appliance) and then control the functions of the hood via your hob.

Appliances can be connected to each other in different ways:

### Home Connect

Two appliances can be connected using the Home Connect app provided that both of them are Home Connect compatible.

Refer to the Home Connect documents supplied for more information.



### Connecting appliances directly

If the appliance is connected directly to a hob, it cannot be connected to your home network as well. The appliance will function as an extractor hood that is not connected to the network and you can continue to operate it via the control panel.

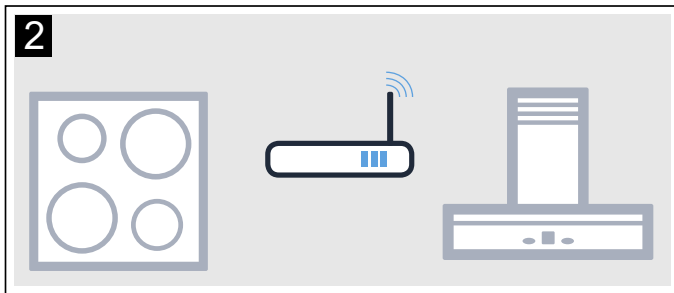
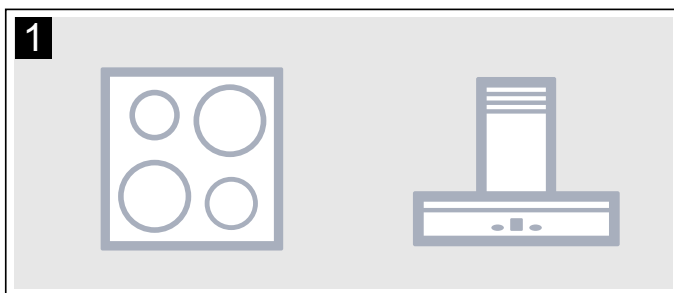

### Connecting appliances via your home network

If the appliances are connected to each other via your home network, both the hood controls on the hob and Home Connect can be used to operate the appliance.

#### Notes

- Make sure you follow the safety instructions in the instruction manual for your extractor hood and that these are complied with even when operating the appliance via the hood controls on the hob.
- If the extractor hood is being operated by means of the controls on the hood itself, this mode of operation always has priority. It is not possible to use the hood controls on the hob during this time.

### Setting up a connection

The hood must be switched off before you can connect the hob and extractor hood.

#### Connecting directly

Make sure that the hob is switched on and is in search mode.

To do this, refer to the section entitled "Connecting to the extractor hood" in the instruction manual for your hob.

#### Notes

- Before connecting the appliance, reset all existing connections to the WiFi or other appliances.
- If your extractor hood is connected directly to the hob, it cannot be connected to your WiFi as well and you will not be able to use Home Connect.

Press and hold the  button until the Home Connect LED starts flashing.

The extractor hood has been connected to the hob when the Home Connect LED stops flashing and remains continuously lit.

### Connecting via your home network

Follow the instructions in the section entitled "Automatic login to your home network" or "Manually logging into your home network" → "Home Connect" on page 11

Once the extractor hood is connected to your home network, you can connect to the hob via the Home Connect app. To do this, follow the instructions on your mobile device.

## Home Connect

This appliance can be networked and also controlled using a mobile device.

If the appliance is not connected to your home network, it will function as an extractor hood with no network connection and can still be operated via the display.

The availability of the Home Connect function depends on the availability of Home Connect services in your country. Home Connect services are not available in every country. You can find more information on this at [www.home-connect.com](http://www.home-connect.com).

### Notes

- Ensure that you follow the safety instructions in this instruction manual and that you comply with these even when you are away from home and are operating the appliance via the Home Connect app. You must also follow the instructions in the Home Connect app.
- Operating the appliance directly from the appliance always takes priority. It is not possible to operate the appliance using the Home Connect app during this time.

## Setting up

To implement settings via Home Connect, you must have installed and set up the Home Connect app on your mobile device.

Refer to the Home Connect documents supplied for more information.

The app will guide you through the entire registration process. Follow the steps specified by the app to implement the settings.

The app must be open in order to perform the set-up process.

### Notes

- In networked standby mode, your appliance requires a maximum of 2 W.
- If you need your device's MAC address to connect to your home network, you can find this next to the rating plate inside the appliance (you will need to remove the filter to see it).

## Automatic registration in the home network

### Notes

- You need a router that has WPS functionality.
- You need to be able to access your router. If you do not have this, follow the steps for "Manually logging into your home network".
- The extractor hood cannot be switched on during the connection process. You can cancel the process at any time by pressing the Ⓛ symbol.
- To connect the extractor hood to your home network, the hood and the light must be switched off.

1. Press and hold the  button until LED 7 on the appliance flashes.
2. Press the **+** button.  
LED 1 and LED 7 will flash.

3. Press the WPS button on the router within the next 2 minutes.

If the extractor hood has successfully connected, it will automatically connect to the Home Connect app. LED 3 and LED 7 will flash.

**Note:** If the extractor hood has been unable to connect, it will automatically allow you to manually connect to your home network. The LED for fan setting 2 and the Home Connect LED will flash. Log the appliance into your home network manually or press the **-** button to try logging in automatically again.

4. On your mobile device, follow the instructions for automatic network login.

The login process is complete when LED 7 on the appliance stops flashing and remains continuously lit.

## Manual registration in the home network

### Notes

- The extractor hood cannot be switched on during the connection process. You can cancel the process at any time by pressing the Ⓛ symbol.
- To connect the extractor hood to your home network, the hood and the light must be switched off.

1. Press and hold the  button until LED 7 on the appliance flashes.
2. Press the **+** button twice to start logging into your home network manually.  
LED 2 and LED 7 will flash.
3. Follow the instructions in the app.



If the extractor hood has successfully connected, it will automatically connect to the Home Connect app. LED 3 and LED 7 will flash.

4. On your mobile device, follow the instructions for manually logging into your network.

The login process is complete when LED 7 on the appliance stops flashing and remains continuously lit.



## Connecting to the app

If the Home Connect app is installed on your mobile device, you can connect it to your extractor hood.

### Notes

- The appliance must be connected to the network.
  - The app must be open.
1. Press and hold the  button until LED 3 and LED 7 start flashing.
  2. On your mobile device, follow the instructions in the Home Connect app.
- The connection process is complete when LED 7 on the appliance stops flashing and remains continuously lit.

## Software update

Using the software update function, your extractor hood's software can be updated (e.g. for the purpose of optimisation, troubleshooting or security updates). To do this, you need to be a registered Home Connect user, have installed the app on your mobile device and be connected to the Home Connect server.

As soon as a software update is available, you will be informed through the Home Connect app and will be able to start the software update via the app.

Once the update has been successfully downloaded, you can start installing it via the Home Connect app if you are on your local area network.

The Home Connect app will inform you once installation is complete.

### Notes

- You can continue to use your extractor hood as normal while updates are downloading.
- Depending on your personal settings in the app, software updates can also be set to download automatically.
- We recommend that you install security updates as soon as possible.

## Remote diagnostics

If a fault occurs, the after-sales service can use remote diagnostics to access your appliance.

Contact the after-sales service, making sure that your appliance is connected to the Home Connect server and checking that the remote diagnostics service is available in your country.

**Note:** For more information and to check whether the remote diagnostics service is available in your country, please visit the Help & Support area of the Home Connect website for your country: [www.home-connect.com](http://www.home-connect.com)

## Resetting the connection

You can reset the connections you have saved on your home network and on Home Connect at any time.

Press and hold the  and **+** buttons until LED 7 on the appliance goes out. An audible signal will sound.

## About data protection

When your appliance is connected for the first time to a WLAN network, which is connected to the Internet, your appliance transmits the following categories of data to the Home Connect server (initial registration):

- Unique appliance identification (consisting of appliance codes as well as the MAC address of the installed WiFi communication module).
- Security certificate of the WiFi communication module (to ensure a secure IT connection).
- The current software and hardware version of your domestic appliance.
- Status of any previous resetting to factory settings.

This initial registration prepares the Home Connect functions for use and is only required when you want to use these Home Connect functions for the first time.

**Note:** Ensure that the Home Connect functions can be used only in conjunction with the Home Connect app. Information on data protection can be accessed in the Home Connect app.

## Declaration of Conformity

Constructa Neff Vertriebs-GmbH hereby declares that the appliance with functionality meets the basic requirements and other relevant provisions of Directive 2014/53/EU.

A detailed RED Declaration of Conformity can be found online at [www.neff-international.com](http://www.neff-international.com) among the additional documents on the product page for your appliance.



2.4 GHz band: max. 100 mW  
5 GHz band: max. 100 mW

	BE	BG	CZ	DK	DE	EE	IE	EL
	ES	FR	HR	IT	CY	LV	LT	LU
	HU	MT	NL	AT	PL	PT	RO	SI
	SK	FI	SE	UK	NO	CH	TR	

5 GHz Wi-Fi: for indoor use only

# Cleaning and maintenance

## **Warning – Risk of burns!**

The appliance will become hot during operation, especially near the bulbs. Allow the appliance to cool down before cleaning.

## **Warning** **Risk of electric shock!**

- Penetrating moisture may result in an electric shock. Clean the appliance using a damp cloth only. Before cleaning, pull out the mains plug or switch off the circuit breaker in the fuse box.
- Do not use any high-pressure cleaners or steam cleaners, which can result in an electric shock.

## **Warning** **Risk of injury!**

- The filter cover may swing out. Always open and close the filter cover slowly. Ensure that the filter cover does not swing out after it is released.
- Risk of trapping body parts when opening and closing the filter cover. Do not reach into the area behind the filter cover and keep your hands away from the hinges.
- Before cleaning the appliance, disconnect it from the Home Connect app to ensure that operation via the Home Connect app is not possible.

## Cleaning agents

To ensure that the different surfaces are not damaged by using the wrong cleaning agent, observe the information in the table. Do not use any of the following:

- Harsh or abrasive cleaning agents,
- Cleaning agents with a high alcohol content,
- Hard scouring pads or cleaning sponges,
- High-pressure cleaners or steam cleaners.

Wash new sponge cloths thoroughly before use.

Follow all instructions and warnings included with the cleaning agents.

Area	Cleaning agent
Stainless steel	Hot soapy water: Clean with a dish cloth and then dry with a soft cloth.  Clean stainless steel surfaces in the grind direction only.  Special stainless steel cleaning products are available from our after-sales service or from specialist retailers. Apply a very thin layer of the cleaning product with a soft cloth.
Painted surfaces	Hot soapy water: Clean using a damp dish cloth and dry with a soft cloth/towel.  Do not use any stainless steel cleaners.
Aluminium and plastic	Glass cleaner: Clean with a soft cloth.

Area	Cleaning agent
Glass	Glass cleaner: Clean with a soft cloth. Do not use a glass scraper.
Controls	Hot soapy water: Clean using a damp dish cloth and dry with a soft cloth/towel.  Risk of electric shock caused by penetrating moisture.  Risk of damage to the electronics from penetrating moisture. Never clean operating controls with a wet cloth.  Do not use any stainless steel cleaners.

## Cleaning the metal mesh grease filters

These instructions apply to several appliance variants. It is possible that individual features are described which do not apply to your appliance.

## **Warning – Risk of fire!**

Fatty deposits in the grease filter may catch fire. Regularly clean the grease filter. Never operate the appliance without a grease filter.

### Notes

- Do not use any aggressive, acidic or alkaline cleaning products.
- We recommend cleaning the grease filters every 2 months.
- When cleaning the metal grease filters, also clean the metal grease filter holder in the appliance using a damp cloth.
- The metal grease filters can be cleaned in the dishwasher or by hand. We recommend cleaning by hand.

### By hand:

**Note:** You can use a special grease solvent for stubborn dirt. It can be ordered via the Online Shop.

- Soak the metal mesh grease filters in a hot soapy solution.
- Clean the filters with a brush and then rinse them thoroughly.
- Leave the metal mesh grease filters to drain.

### In the dishwasher:

**Note:** Slight discolouration may occur if the metal grease filters are cleaned in the dishwasher. This discolouration has no effect on the performance of the metal grease filters.

- Use normal domestic dishwashing detergents.
- Do not clean heavily soiled metal grease filters together with cookware.
- Place the metal grease filters in the dishwasher, leaving plenty of space around them. Do not trap the metal grease filters.
- Select a temperature of no more than 70 °C.

## Removing metal grease filter

### **⚠ Warning – Risk of injury!**

Use a stable ladder and make sure it is in a secure position. Do not lean over the hob and do not step on the work surface or the hob.

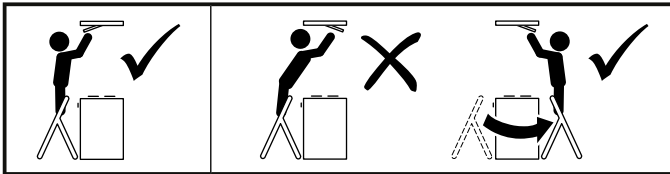

### **⚠ Warning – Risk of injury!**

The filter cover may swing out. Always open and close the filter cover slowly. Ensure that the filter cover does not swing out after it is released.

1. Press the lock on the filter cover.

**Note:** The filter cover is heavy. Take the filter cover by two hands and hold in place.

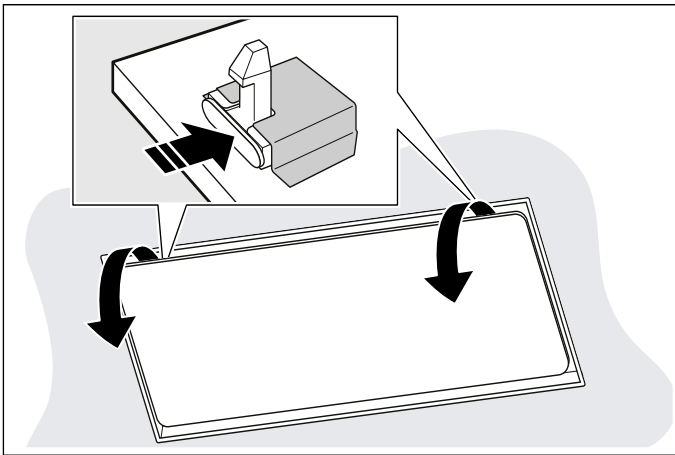

2. Open the filter cover fully and without pulling on it.

**Note:** The filter cover may swing out. Always open and close the filter cover slowly. Ensure that the filter cover does not swing out after it is released.

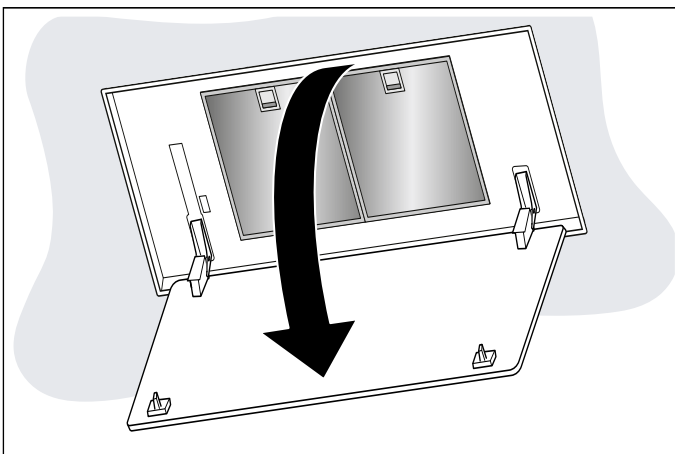

3. Open the lock.

**Note:** To avoid causing damage, do not bend the metal grease filter.



4. Take the metal grease filter out of the holder.

### **Notes**

- Fat may accumulate in the bottom of the metal grease filter.
- Hold the metal grease filter level to prevent fat from dripping out.

5. Clean the inside of the appliance.

6. Clean the metal grease filter and let it dry before refitting.

## Installing the metal mesh grease filter

1. Insert metal grease filter.

While doing this, place your other hand under the metal grease filter.

2. Fold up metal grease filter and engage the lock.

3. Close the filter cover upwards.

**Note:** Ensure that the filter cover lock engages correctly.



## Replacing the batteries in the remote control

### **Warning**

#### **Risk of injury!**

- Batteries can be easily swallowed by children. Keep batteries out of the reach of children. Do not allow children to change batteries without supervision.
- Batteries may explode. Do not charge or short-circuit the batteries. Do not throw batteries into a fire.
- The connection terminals must not be short circuited.
- Only batteries of the specified type may be used. Different types of batteries or old and new batteries must not be mixed together.
- Rechargeable batteries must not be used.

### **Caution!**

Damage to the remote control caused by leaking batteries. Remove the batteries in the remote control if the remote control is not being used over a longer period of time.

1. Remove the cover.
2. Remove the batteries.

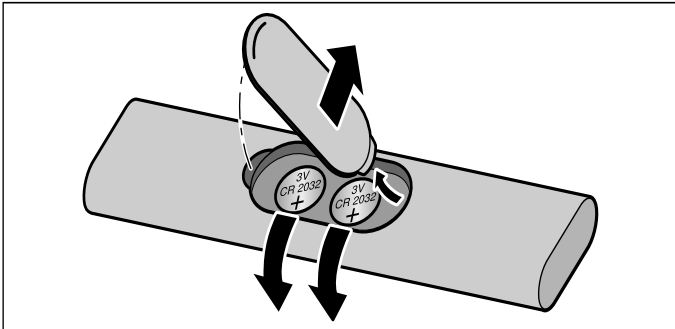

3. Correctly insert the new batteries (3 V CR 2032).

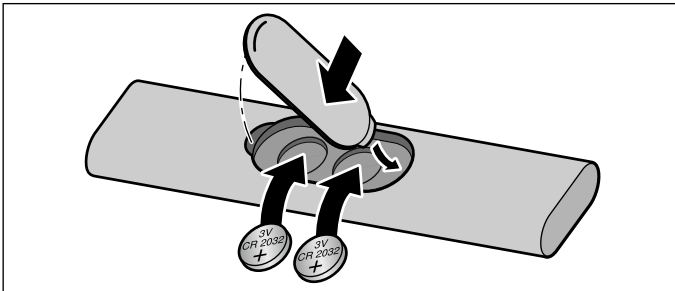

### **Caution!**

Remove batteries that are flat or defective from the remote control and dispose of them safely in accordance with local regulations. Do not dispose of batteries alongside general household waste.

## ? Trouble shooting

Malfunctions often have simple explanations. Please read the following notes before calling the after-sales service.

### **Warning – Risk of electric shock!**

Incorrect repairs are dangerous. Repairs may only be carried out and damaged power cables replaced by one of our trained after-sales technicians. If the appliance is defective, unplug the appliance from the mains or switch off the circuit breaker in the fuse box. Contact the after-sales service.

### **LED lights**

Defective LED lights must only be replaced by the manufacturer, their customer service department or a licensed technician (electrician).

### **Malfunction table**

Fault	Possible cause	Solution
The appliance does not work	The plug is not plugged into the mains	Connect the appliance to the power supply
	Power cut	Check whether other kitchen appliances are working
	The fuse is faulty	Check in the fuse box to make sure that the fuse for the appliance is in working order
The lighting is not working	The LED lights are defective	Call the after-sales service
The remote control is not working	The battery is flat	Change the batteries in the remote control, see section → "Replacing the batteries in the remote control" on page 15
After the appliance has been switched off, the LEDs 1-5 flash three times.	The battery is nearly flat	Change the batteries in the remote control, see section → "Replacing the batteries in the remote control" on page 15
LED 1 or LED 2 flashes in the display	The metal grease filter or the activated charcoal filter is saturated.	Clean the metal grease filter or replace the activated charcoal filter. → "Cleaning the metal mesh grease filters" on page 13

## Customer service

When calling us, please give the product number (E no.) and the production number (FD no.) so that we can provide you with the correct advice. The rating plate with these numbers can be found inside the appliance (remove the metal mesh grease filter to gain access).

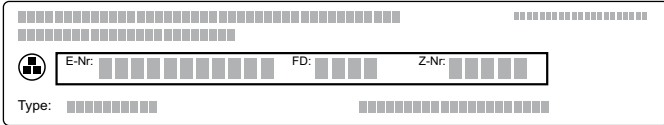

You can make a note of the numbers of your appliance and the telephone number of the after-sales service in the space below to save time should it be required.

E no.	FD no.
<b>After-sales service</b> 	

Please be aware that a visit by an after-sales engineer will be charged if a problem turns out to be the result of operator error, even during the warranty period.

Please find the contact data of all countries in the enclosed customer service list.

### To book an engineer visit and product advice

**GB** 0344 892 8989

Calls charged at local or mobile rate.

**IE** 01450 2655

0.03 € per minute at peak. Off peak 0.0088 € per minute.

Rely on the professionalism of the manufacturer. You can therefore be sure that the repair is carried out by trained service technicians who carry original spare parts for your appliances.

## Accessories

(not included in the scope of delivery)

**Note:** These instructions apply to several appliance models. It may be the case that an optional accessory that is listed does not apply for your appliance.

**Note:** Observe the installation instructions in the accessory.

Accessory/ies	Order number
CleanAir recirculation module with easy-change filter (cannot be regenerated), stainless steel	Z52JCC0N0
CleanAir recirculation module with filter (can be regenerated), stainless steel	Z52JCD0N0
CleanAir recirculation module with easy-change filter (can be regenerated), white	Z52JCC0W0
CleanAir recirculation module with filter (can be regenerated), white	Z52JCD0W0
Easy-change filter for circulating-air mode (cannot be regenerated)	Z5170X1
Filter for air recirculation module (can be regenerated)	Z50XXP0X0

# INSTALLATION INSTRUCTIONS

- This appliance is fitted to the kitchen ceiling or a sturdy suspended ceiling.
- The surfaces of the appliance are sensitive. Avoid damaging them during installation.

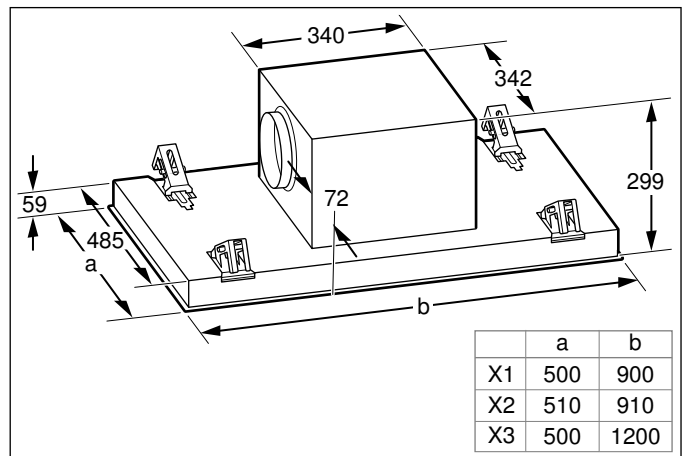
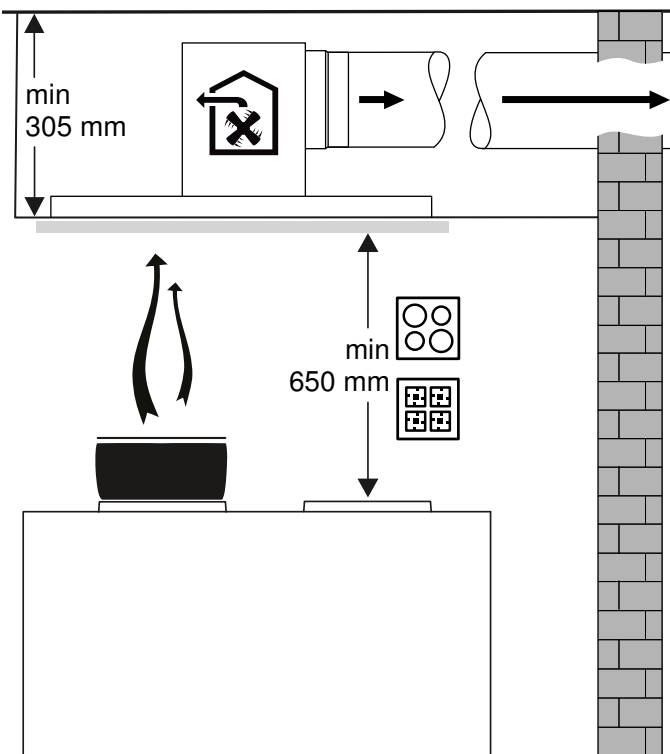
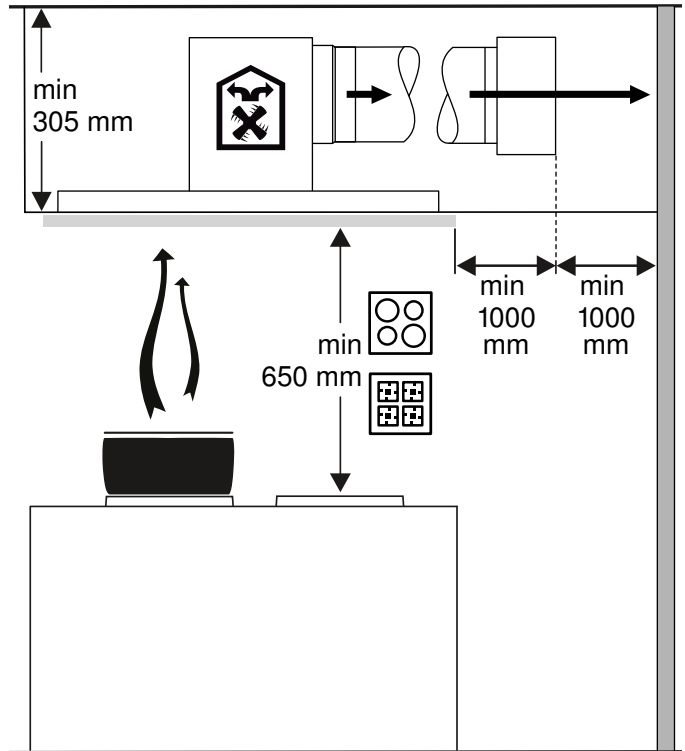
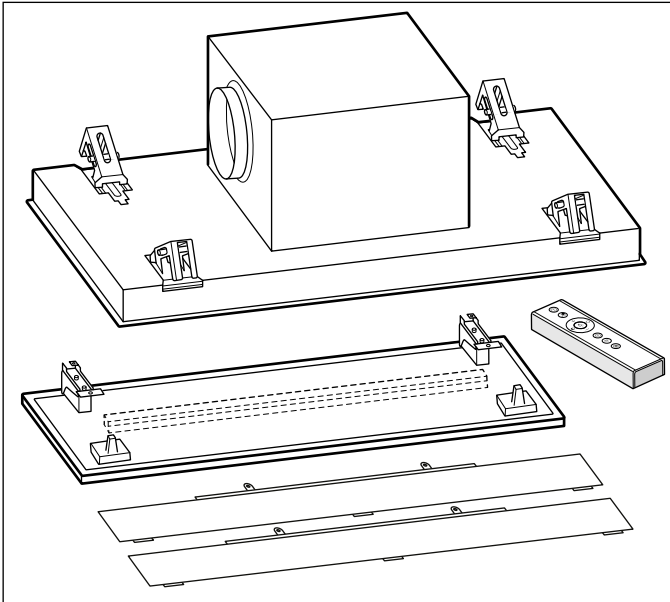



## Important safety information

Read these instructions carefully. Only then will you be able to operate your appliance safely and correctly. Retain the instruction manual and installation instructions for future use or for subsequent owners.

Check the appliance for damage after unpacking it. Do not connect the appliance if it has been damaged in transport.

The appliance can only be used safely if it is correctly installed according to the safety instructions. The installer is responsible for ensuring that the appliance works perfectly at its installation location.

Only a licensed professional may connect appliances without plugs. Damage caused by incorrect connection is not covered under warranty.

The surfaces of the appliance are easily damaged. Avoid damaging them during installation.

For the installation, observe the currently valid building regulations and the regulations of the local electricity and gas suppliers.

### Warning – Risk of death!

- Risk of poisoning from flue gases that are drawn back in. The exhaust air must not be conveyed into a functioning smoke or exhaust gas flue or into a shaft which is used to ventilate installation rooms that contain heating appliances. If the exhaust air is to be conveyed into a non-functioning smoke or exhaust gas flue, you must obtain the consent of the heating engineer responsible.
- Risk of poisoning from flue gases that are drawn back in.  
Always ensure adequate fresh air in the room if the appliance is being operated in exhaust air mode at the same time as room air-dependent heat-producing appliance is being operated.

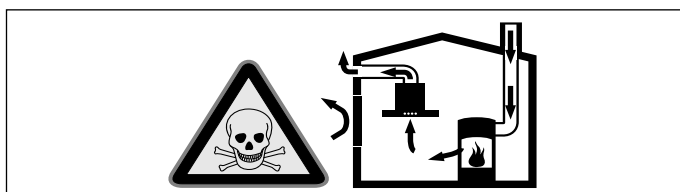

Room air-dependent heat-producing appliances (e.g. gas, oil, wood or coal-operated heaters, continuous flow heaters or water heaters) obtain combustion air from the room in which they are installed and discharge the exhaust gases into the open air through an exhaust gas system (e.g. a chimney).

In combination with an activated vapour extractor hood, room air is extracted from the kitchen and neighbouring rooms - a partial vacuum is produced if not enough fresh air is supplied. Toxic gases from the chimney or the extraction shaft are sucked back into the living space.

- Adequate incoming air must therefore always be ensured.
- An incoming/exhaust air wall box alone will not ensure compliance with the limit. Safe operation is possible only when the partial vacuum in the place where the heat-producing appliance is installed does not exceed 4 Pa (0.04 mbar). This can be achieved when the air needed for combustion is able to enter through openings that cannot be sealed, for example in doors, windows, incoming/exhaust air wall boxes or by other technical means.

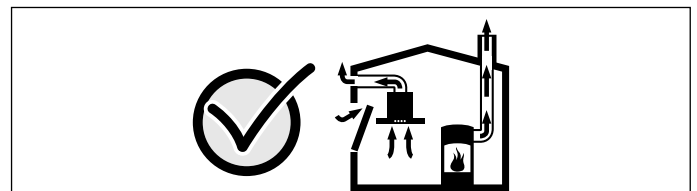

In any case, consult your responsible Master Chimney Sweep. He is able to assess the house's entire ventilation setup and will suggest the suitable ventilation measures to you.

Unrestricted operation is possible if the vapour extractor hood is operated exclusively in the circulating-air mode.

- Risk of poisoning from flue gases that are drawn back in. If installing a ventilation system in a room with a heat-producing appliance connected to a chimney/flue, the electricity supply to the hood must be equipped with a suitable safety switch.

**⚠ Warning – Risk of fire!**

- Fatty deposits in the grease filter may catch fire. The specified safety clearances must be complied with in order to prevent a build-up of heat. Refer to the information provided for your cooker. If gas and electric hobs are being operated together, the largest specified clearance applies.
- Grease deposits in the grease filter may catch fire. Never work with naked flames close to the appliance (e.g. flambéing). Do not install the appliance near a heat-producing appliance for solid fuel (e.g. wood or coal) unless a closed, non-removable cover is available. There must be no flying sparks.

When conveying the exhaust air, official and legal regulations (e.g. state building regulations) must be followed.

**⚠ Warning – Risk of injury!**

- Components inside the appliance may have sharp edges. Wear protective gloves.
- The appliance may fall down if it has not been properly fastened in place. All fastening components must be fixed firmly and securely.
- The appliance is heavy. To move the appliance, 2 people are required. Use only suitable tools and equipment.
- The appliance is very heavy. The appliance must not be fitted directly onto plasterboard or similar lightweight materials. To ensure correct installation, you must use a material which is sufficiently stable and suitable for both the structural conditions and the weight of the appliance.
- Changes to the electrical or mechanical assembly are dangerous and may lead to malfunctions. Do not make any changes to the electrical or mechanical assembly.
- Risk of falling when working on the appliance. Use a stable stepladder.
- Risk of trapping body parts when opening and closing the hinges. Keep your hands away from the hinges.
- The filter cover may swing out. Always open and close the filter cover slowly. Ensure that the filter cover does not swing out after it is released.

**⚠ Warning – Risk of electric shock!**

- Components inside the appliance may have sharp edges. These may damage the connecting cable. Do not kink or pinch the connecting cable during installation.
- It must always be possible to disconnect the appliance from the electricity supply. The appliance must only be connected to a protective contact socket that has been correctly installed. The mains plug of the mains power cable must be easily accessible after installation of the appliance. If this is not possible, an all-pole isolating switch must be integrated into the permanent electrical installation according to the conditions of overvoltage category III and according to the installation regulations. The permanent electrical installation must only be wired by a professional electrician. We recommend installing a residual-current circuit breaker (RCCB) in the appliance's power supply circuit.
- Incorrect repairs are dangerous. Repairs may only be carried out and damaged power cables replaced by one of our trained after-sales technicians. If the appliance is defective, unplug the appliance from the mains or switch off the circuit breaker in the fuse box. Contact the after-sales service.

**⚠ Warning – Danger of suffocation!**

Packaging material is dangerous to children. Never allow children to play with packaging material.



## General information

The surfaces of the appliance are easily damaged. Avoid damaging them during installation.

### Exhaust duct

**Note:** The appliance manufacturer does not assume any warranty for complaints attributable to the pipe section.

- The appliance achieves its optimum performance by means of a short, straight exhaust air pipe and as large a pipe diameter as possible.
- As a result of long rough exhaust air pipes, many pipe bends or pipe diameters that are smaller than 150 mm, the optimum extraction performance is not achieved and fan noise is increased.
- The pipes or hoses for laying the exhaust air line must consist of non-combustible material.

Risk of damage from returning condensate. Install the exhaust duct in such a way that it falls away from the appliance slightly (1° slope).

### Round pipes

An inner diameter of 150 mm is recommended.

### Flat ducts

The inner cross-section must correspond to the diameter of the round pipes.

**dia. 150 mm ca. 177 cm<sup>2</sup>**

- Flat ducts should have no sharp bends.
- Use sealing strips for different pipe diameters.

## Electrical connection

### **⚠ Warning – Risk of electric shock!**

It must always be possible to disconnect the appliance from the electricity supply. The appliance must only be connected to a protective contact socket that has been correctly installed.

The mains plug of the mains power cable must be easily accessible after installation of the appliance. If this is not possible, an all-pole isolating switch must be integrated into the permanent electrical installation according to the conditions of overvoltage category III and according to the installation regulations. The permanent electrical installation must only be wired by a professional electrician. We recommend installing a residual-current circuit breaker (RCCB) in the appliance's power supply circuit.

### **⚠ Warning – Risk of electric shock!**

Components inside the appliance may have sharp edges. These may damage the connecting cable. Do not kink or pinch the connecting cable during installation.

The required connection information can be found on the rating plate inside the appliance; to access it, you will need to remove the activated charcoal filter.

**Length of the cable: approx. 1.30 m**

This appliance complies with the EC interference suppression regulations.

The appliance must be disconnected from the power supply whenever installation work is being carried out.



## Installation

### Preparing for installation

- We recommend a distance of at least 700 mm and a maximum of 1300 mm. The cooking vapours are more difficult to draw in the further away they are from the hob.
- So that cooking vapours are optimally drawn in, install the extractor hood in the middle of the hob.
- The installation site must be easily accessible, so that the appliance can be accessed freely for servicing.

### Checking the ceiling

- The ceiling must be flat, horizontal and adequately load-bearing.
- The max. weight of the appliance is **40 kg**.

### Notes

- Check the cut-out area for existing cables of other appliances.
- When mounting the extractor hood, a suitable substructure is required that is securely fastened to the concrete ceiling.
- Do not fit the appliance directly onto plasterboard (or similar lightweight materials) in a suspended ceiling.
- To ensure correct installation, you must use a material which is sufficiently stable and suitable for both the structural conditions and the weight of the appliance.

### Preparing the ceiling

The ceiling must still be sturdy after the cut-outs have been made.

1. Cover the hob to protect it from damage.
2. Make the cut-out in the ceiling.

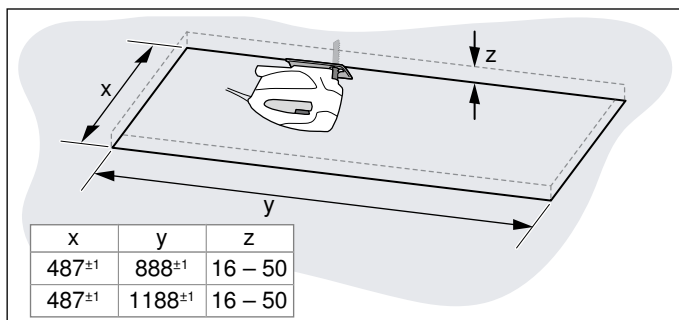

3. After making the cut-outs, remove any shavings.

### Installing the appliance

#### Warning – Risk of injury!

Components inside the appliance may have sharp edges. Wear protective gloves.

#### Warning – Risk of injury!

Risk of trapping body parts when opening and closing the hinges. Keep your hands away from the hinges.

1. Tilt the transport lock slightly upwards and carefully pull it upwards and out at an angle.

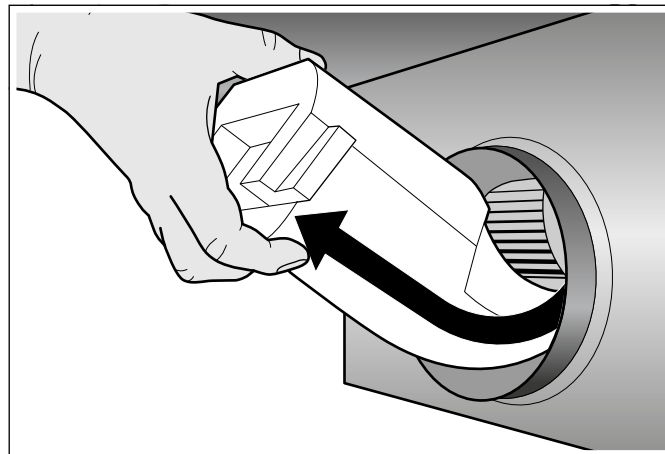

2. Remove residues from polystyrene from the interior of the appliance.
3. Remove the grease filter.
4. Remove the side covers.

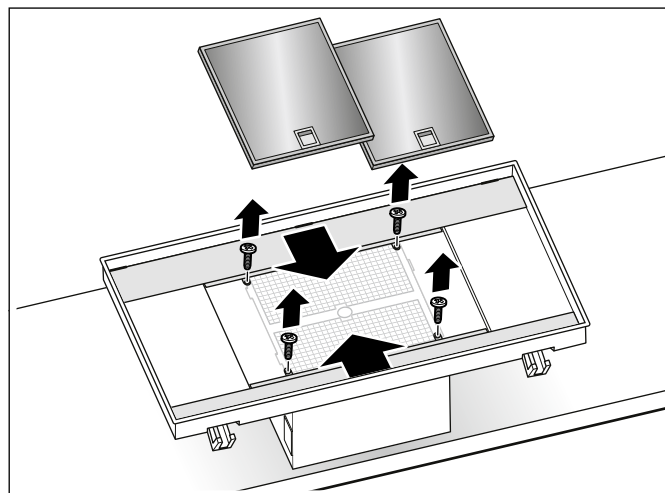

**Note:** Avoid scratching the side covers as they are within view.

5. Fully insert the appliance into the cut-out until you hear the mounting brackets engage.

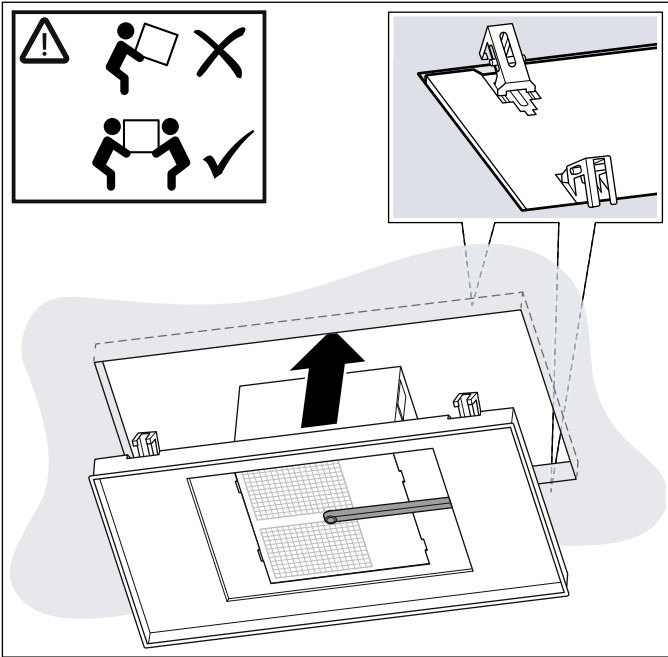

6. Carefully screw in diagonally opposite screws.  
**Note:** Tighten the screws one at a time so that the appliance is not wedged in the cut-out.

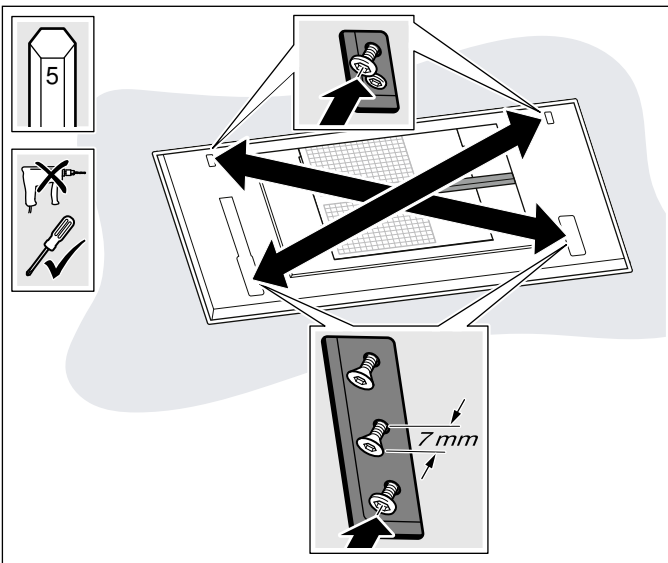

7. Carefully tighten screws in succession until the appliance is flush-mounted on the ceiling.  
**Note:** Do not overtighten the screws to ensure that the appliance is not damaged.

## Connecting the appliance

1. Press together the cable duct at the sides and remove it.

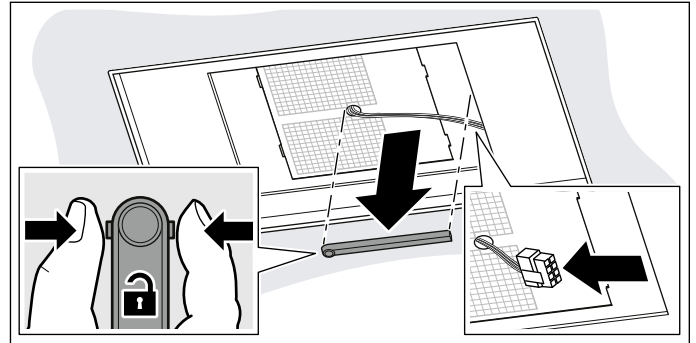

2. Disconnect the cable at the appropriate point.
3. Undo the opposite screws to loosen the fan box.

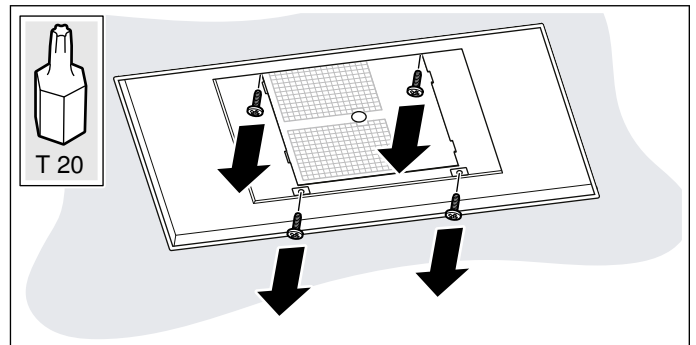

4. Turn the fan box into the correct position according to the installation situation.

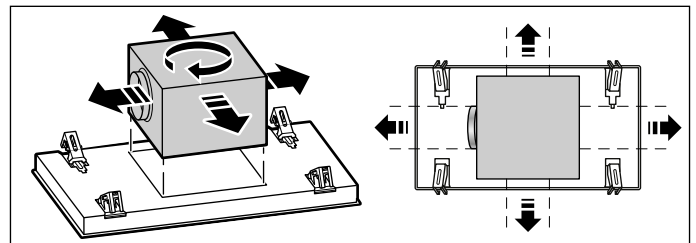

5. Push the fan box to the side and connect the power supply.

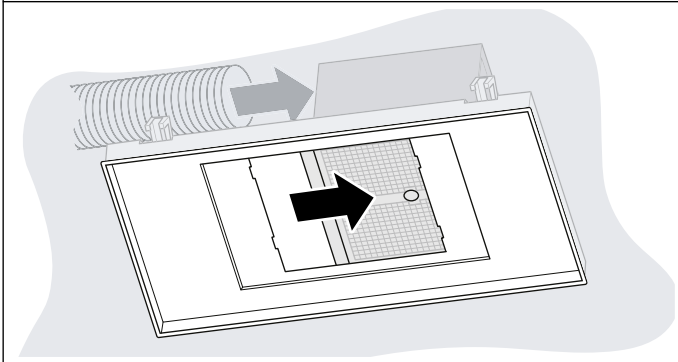
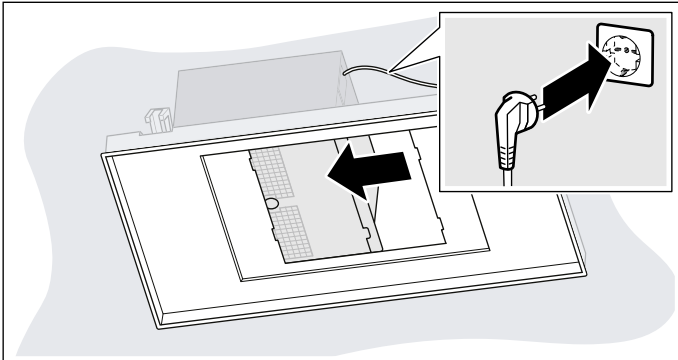

6. Push the fan box to the other side and connect the ducting.  
 7. Position the fan box in the centre and screw it firmly in place.  
 8. Connect the cable.

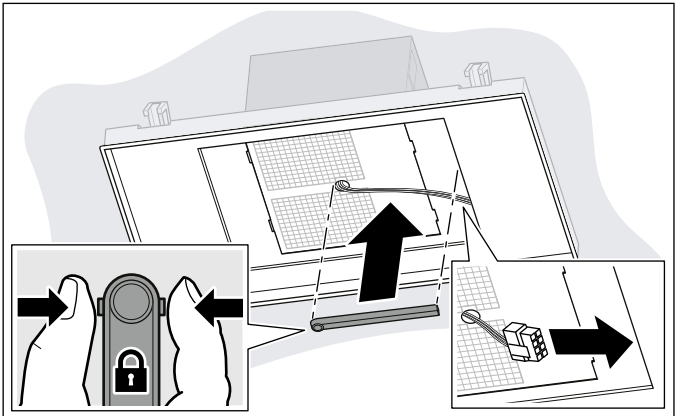

9. Press together the cable duct at the sides, attach and click into place.

### Fitting the filter cover

**⚠ Warning – Risk of injury!**

Components inside the appliance may have sharp edges. Wear protective gloves.

**⚠ Warning – Risk of injury!**

Risk of trapping body parts when opening and closing the hinges. Keep your hands away from the hinges.

**Note:** Avoid scratching the side covers as they are within view.

1. Open the hinges on the filter cover.
2. Mount the filter cover on the designated screws and push it backwards/forwards depending on the key hole opening into the narrow section.
3. Tighten the fastening screws of the hinges.

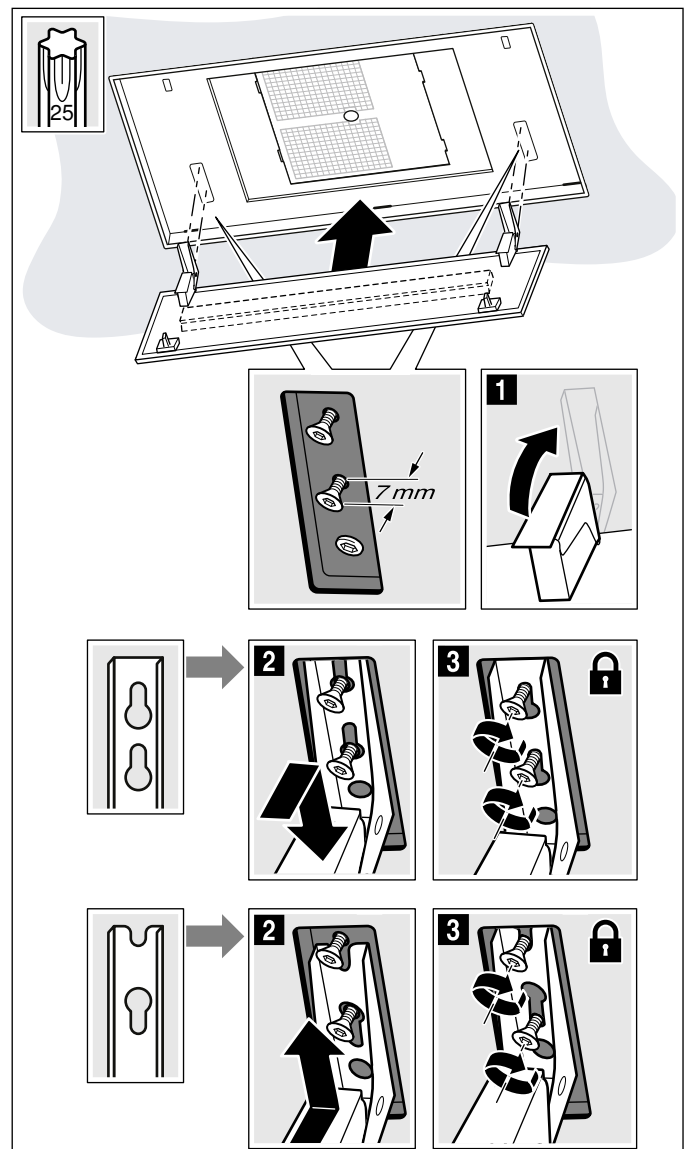

4. Check whether the appliance frame is lying flush. Tighten the screws once again if necessary.
5. Undo the screws on the hinges up to approx. 7 mm.  
**Note:** Do not loosen them fully.

6. Unhook and remove the filter cover.

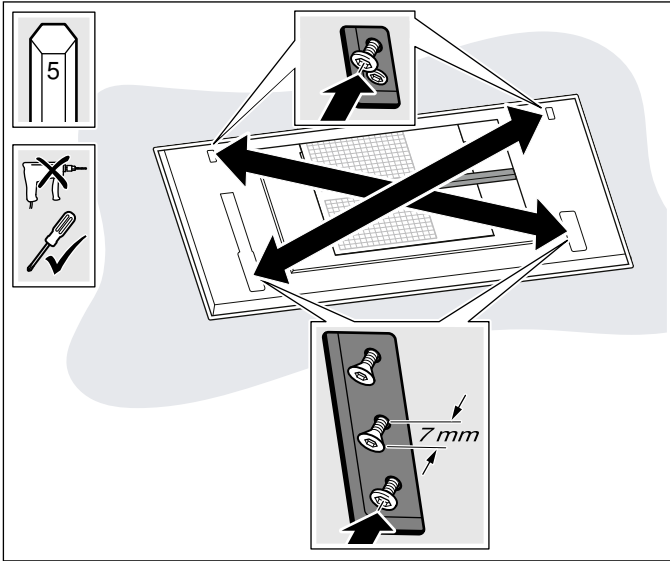

7. Insert the side cover into the corresponding openings.

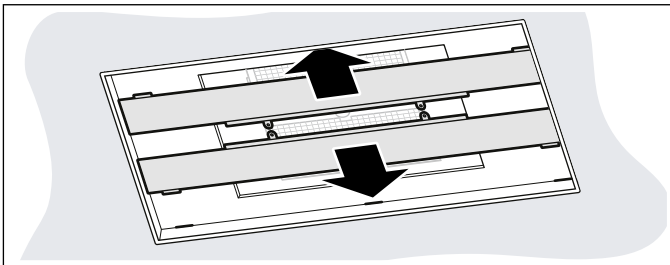

8. Push the side covers slightly in the direction of the appliance frame and screw firmly in place.

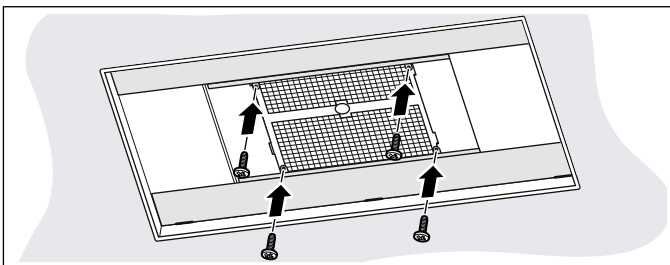

9. Refit the filter cover and screw it firmly in place.

10. Insert the cable, depending on the appliance model A or B.

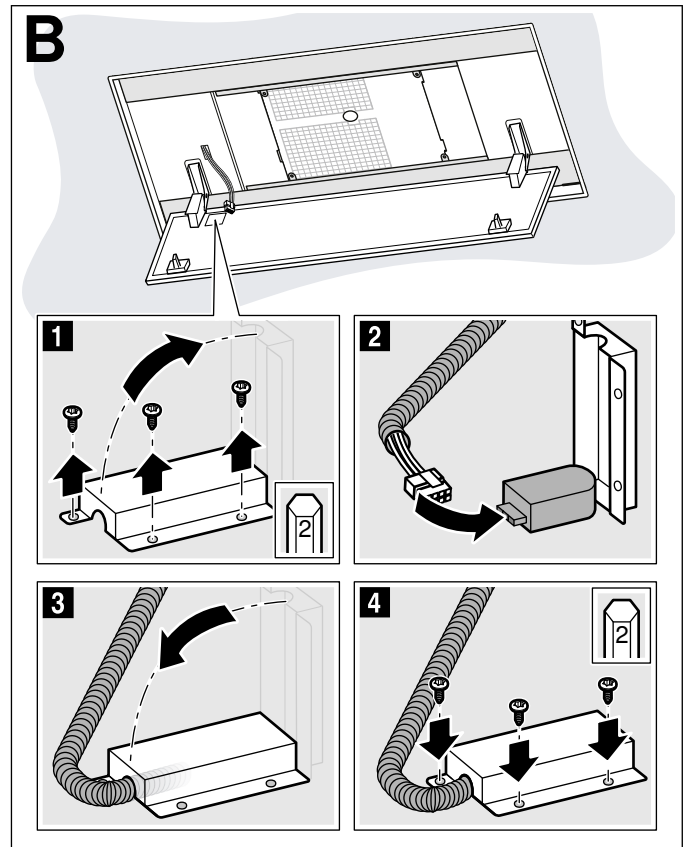
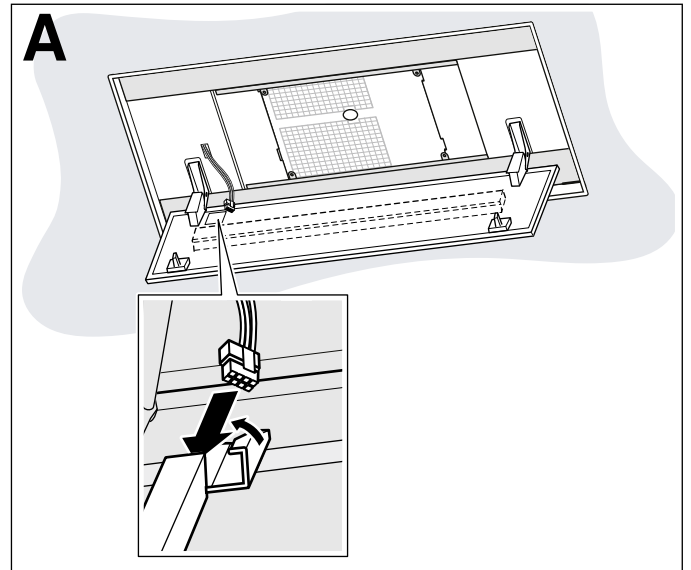

**Note:** The metal cover has sharp edges. Protect the filter cover against scratches.

11. Insert the metal grease filter.

12. Swing the filter cover up and ensure that it engages.



## Removing the appliance

### **⚠ Warning – Risk of injury!**

Components inside the appliance may have sharp edges. Wear protective gloves.

### **⚠ Warning – Risk of injury!**

Risk of trapping body parts when opening and closing the hinges. Keep your hands away from the hinges.

1. Disconnect the appliance from the power supply.
2. Swing down the filter cover.
3. Remove the metal grease filters.
4. Press together the cable duct at the sides and remove it.
5. Loosen the screws on the side covers.
6. Remove the side covers.
7. Undo the screws on the hinges up to approx. 7 mm.  
**Note:** Do not loosen them fully.
8. Unhook and remove the filter cover.
9. Loosen the screws on the fan box, remove the ducting and pull out the mains plug. Then screw the fan box firmly back in place.
10. Loosen the screws on the mounting covers.

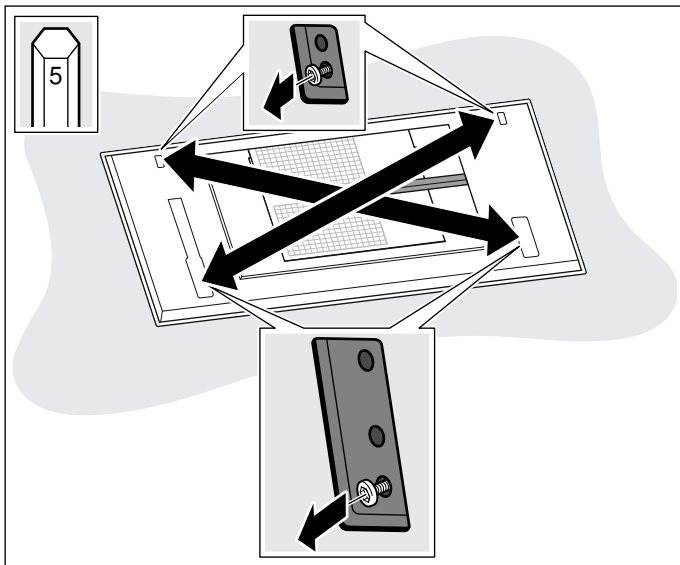

11. Push the removal slide inwards to loosen the mounting brackets.

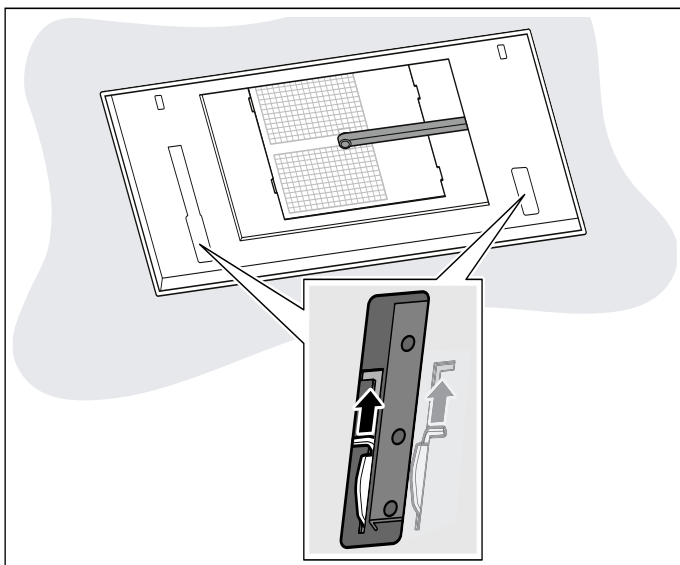

12. Release the appliance slowly at an angle.

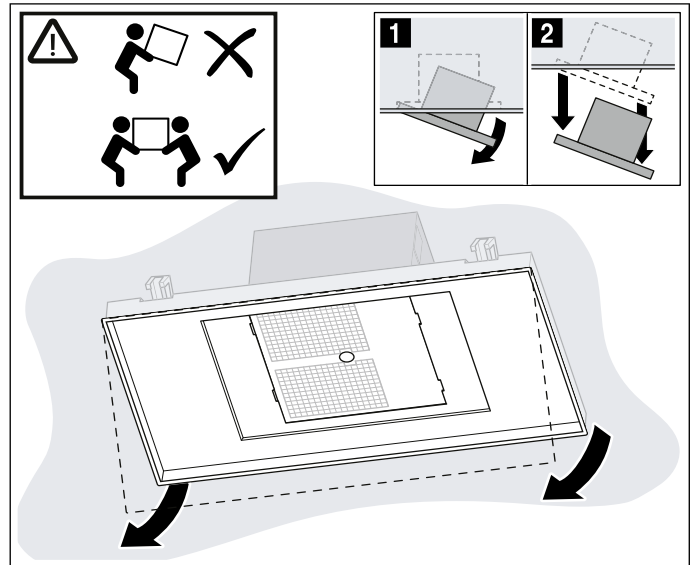

13. Insert the side covers into the corresponding openings and screw them in.









REGISTER YOUR PRODUCT  
ONLINE [NEFF-HOME.COM](http://NEFF-HOME.COM)



Constructa NEFF Vertriebs-GmbH |  
Carl-Wery-Straße 34 | 81739 Munich | Germany

9001371636  
980911  
en