



















DOUBLE OVEN

[en] INSTRUCTION MANUAL

J1GCC0A.0B

Table of contents

 Intended use	4	 Appliance door	19
 Important safety information	4	Main oven – Fitting and removing the glass panels . . .	19
General information	4	Top oven – Fitting and removing the glass panels . . .	20
Halogen lamp	5	 Trouble shooting	22
 Causes of damage	6	Rectifying faults yourself	22
General information	6	Replacing the bulb in the top of the cooking compartment	22
 Environmental protection	6	 Customer service	23
Saving energy	6	E number and FD number	23
Environmentally-friendly disposal	7	 Tested for you in our cooking studio	23
 Getting to know your appliance	8	General information	23
Control panel	8	Baking	24
Buttons and display	8	Roasting, braising and grilling	26
Types of heating and functions	9	Ready meals	30
Temperature	10	Desserts	31
Cooking compartment	10	Acrylamide in foodstuffs	31
 Accessories	10	Drying	31
Control accessories	10	Preserving	32
Inserting accessories	10	Prove dough	33
Optional accessories	11	Defrosting	33
 Before using for the first time	12	Keeping warm	33
Initial use	12	Test dishes	34
Cleaning the cooking compartment	12		
Cleaning the accessories	12		
 Operating the appliance	13		
Switching the appliance on and off	13		
Setting the heating function and temperature	13		
Heating-up indicator	13		
Rapid heating	13		
 Time-setting options	14		
Setting the timer	14		
Setting the cooking time	14		
Setting the end time	14		
Setting the time	15		
Checking, changing or deleting settings	15		
 Childproof lock	15		
Activating and deactivating	15		
 Cleaning	16		
Suitable cleaning agents	16		
Keeping the appliance clean	17		
 Rails	17		
Detaching and refitting the rails	17		
Detaching and refitting the rails	18		

Additional information on products, accessories, replacement parts and services can be found at www.neff-international.com and in the online shop www.neff-eshop.com

Intended use

Read these instructions carefully. Only then will you be able to operate your appliance safely and correctly. Retain the instruction manual and installation instructions for future use or for subsequent owners.

This appliance is only intended to be fully fitted in a kitchen. Observe the special installation instructions.

Check the appliance for damage after unpacking it. Do not connect the appliance if it has been damaged in transport.

Only a licensed professional may connect appliances without plugs. Damage caused by incorrect connection is not covered under warranty.

This appliance is intended for domestic use only. The appliance must only be used for the preparation of food and drink. The appliance must be supervised during operation. Only use this appliance indoors.

This appliance is intended for use up to a maximum height of 4000 metres above sea level.

This appliance may be used by children over the age of 8 years old and by persons with reduced physical, sensory or mental capabilities or by persons with a lack of experience or knowledge if they are supervised or are instructed by a person responsible for their safety how to use the appliance safely and have understood the associated hazards.

Children must not play with, on, or around the appliance. Children must not clean the appliance or carry out general maintenance unless they are at least 15 years old and are being supervised.

Keep children below the age of 8 years old at a safe distance from the appliance and power cable.

Always slide accessories into the cooking compartment the right way round.

→ "Accessories" on page 10

Important safety information

General information

Warning – Risk of fire!

- Combustible items stored in the cooking compartment may catch fire. Never store combustible items in the cooking compartment. Never open the appliance door if there is smoke inside. Switch off the appliance and unplug it from the mains or switch off the circuit breaker in the fuse box.
- Loose food remnants, fat and meat juices may catch fire. Before using the appliance, remove the worst of the food remnants from the cooking compartment, heating elements and accessories.
- A draught is created when the appliance door is opened. Greaseproof paper may come into contact with the heating element and catch fire. Do not place greaseproof paper loosely over accessories during preheating. Always weight down the greaseproof paper with a dish or a baking tin. Only cover the surface required with greaseproof paper. Greaseproof paper must not protrude over the accessories.

Warning – Risk of burns!

- The appliance becomes very hot. Never touch the interior surfaces of the cooking compartment or the heating elements. Always allow the appliance to cool down. Keep children at a safe distance.
- Accessories and ovenware become very hot. Always use oven gloves to remove accessories or ovenware from the cooking compartment.
- Alcoholic vapours may catch fire in the hot cooking compartment. Never prepare food containing large quantities of drinks with a high alcohol content. Only use small quantities of drinks with a high alcohol content. Open the appliance door with care.

⚠ Warning – Risk of scalding!

- The accessible parts become hot during operation. Never touch the hot parts. Keep children at a safe distance.
- When you open the appliance door, hot steam can escape. Steam may not be visible, depending on its temperature. When opening, do not stand too close to the appliance. Open the appliance door carefully. Keep children away.
- Water in a hot cooking compartment may create hot steam. Never pour water into the cooking compartment when the cooking compartment is hot.

⚠ Warning – Risk of injury!

- Scratched glass in the appliance door may develop into a crack. Do not use a glass scraper, sharp or abrasive cleaning aids or detergents.
- The hinges on the appliance door move when opening and closing the door, and you may be trapped. Keep your hands away from the hinges.

⚠ Warning – Risk of electric shock!

- Incorrect repairs are dangerous. Repairs may only be carried out and damaged power cables replaced by one of our trained after-sales technicians. If the appliance is defective, unplug the appliance from the mains or switch off the circuit breaker in the fuse box. Contact the after-sales service.
- The cable insulation on electrical appliances may melt when touching hot parts of the appliance. Never bring electrical appliance cables into contact with hot parts of the appliance.
- Do not use any high-pressure cleaners or steam cleaners, which can result in an electric shock.
- A defective appliance may cause electric shock. Never switch on a defective appliance. Unplug the appliance from the mains or switch off the circuit breaker in the fuse box. Contact the after-sales service.

⚠ Warning – Hazard due to magnetism!

Permanent magnets are used in the control panel or in the control elements. They may affect electronic implants, e.g. heart pacemakers or insulin pumps. Wearers of electronic implants must stay at least 10 cm away from the control panel.

Halogen lamp**⚠ Warning – Risk of burns!**

The bulbs in the cooking compartment become very hot. There is still a risk of burning your skin for some time after they have been switched off. Do not touch the glass cover. Avoid contact with your skin when cleaning.

⚠ Warning – Risk of electric shock!

When replacing the cooking compartment bulb, the bulb socket contacts are live. Before replacing the bulb, unplug the appliance from the mains or switch off the circuit breaker in the fuse box.

Causes of damage

General information

Caution!

- Accessories, foil, greaseproof paper or ovenware on the cooking compartment floor: do not place accessories on the cooking compartment floor. Do not cover the cooking compartment floor with any sort of foil or greaseproof paper. Do not place ovenware on the cooking compartment floor if a temperature of over 50 °C has been set. This will cause heat to accumulate. The baking and roasting times will no longer be correct and the enamel will be damaged.
- Aluminium foil: Aluminium foil in the cooking compartment must not come into contact with the door glass. This could cause permanent discolouration of the door glass.
- Water in a hot cooking compartment: do not pour water into the cooking compartment when it is hot. This will cause steam. The temperature change can cause damage to the enamel.
- Moisture in the cooking compartment: Over an extended period of time, moisture in the cooking compartment may lead to corrosion. Allow the cooking compartment to dry after use. Do not keep moist food in the closed cooking compartment for extended periods of time. Do not store food in the cooking compartment.
- Cooling with the appliance door open: Following operation at high temperatures, only allow the cooking compartment to cool down with the door closed. Do not trap anything in the appliance door. Even if the door is only left open a crack, the front of nearby furniture may become damaged over time. Only leave the cooking compartment to dry with the door open if a lot of moisture was produced whilst the oven was operating.
- Fruit juice: when baking particularly juicy fruit pies, do not pack the baking tray too generously. Fruit juice dripping from the baking tray leaves stains that cannot be removed. If possible, use the deeper universal pan.
- Extremely dirty seal: If the seal is very dirty, the appliance door will no longer close properly during operation. The fronts of adjacent units could be damaged. Always keep the seal clean. Never operate the appliance if the seal is damaged or missing. → "Cleaning" on page 16
- Appliance door as a seat, shelf or worktop: Do not sit on the appliance door, or place or hang anything on it. Do not place any cookware or accessories on the appliance door.
- Inserting accessories: depending on the appliance model, accessories can scratch the door panel when closing the appliance door. Always insert the accessories into the cooking compartment as far as they will go.
- Carrying the appliance: do not carry or hold the appliance by the door handle. The door handle cannot support the weight of the appliance and could break.

Environmental protection

Your new appliance is particularly energy-efficient. Here you can find tips on how to save even more energy when using the appliance, and how to dispose of your appliance properly.

Saving energy

- Only preheat the appliance if this is specified in the recipe or in the tables in the operating instructions.
- Leave frozen food to defrost before placing it in the cooking compartment.

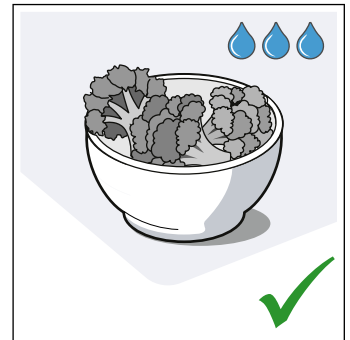
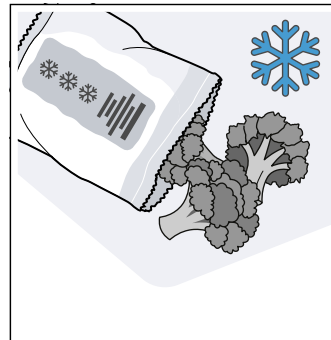

- Use baking tins that are dark-coloured, painted black or have an enamel coating. These absorb the heat particularly well.

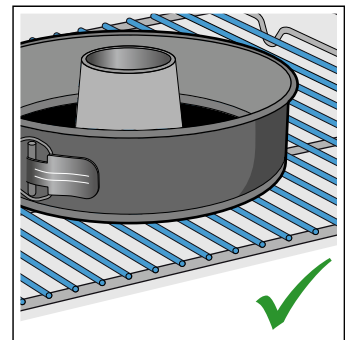
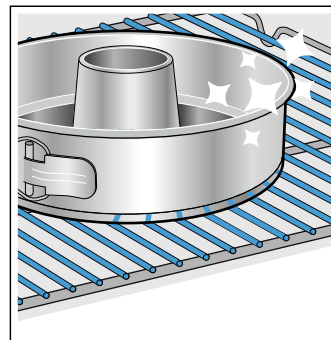

- Remove any unnecessary accessories from the cooking compartment.

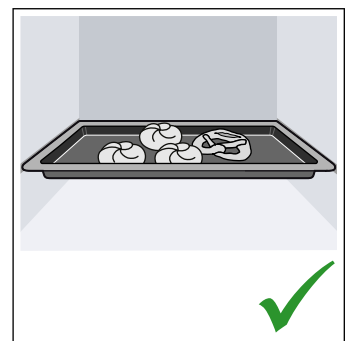
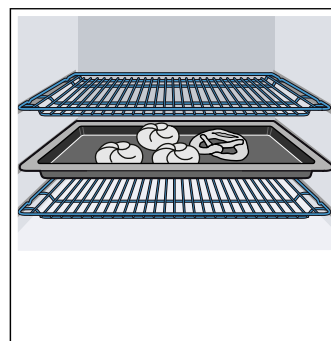

- Open the appliance door as infrequently as possible when the appliance is in use.

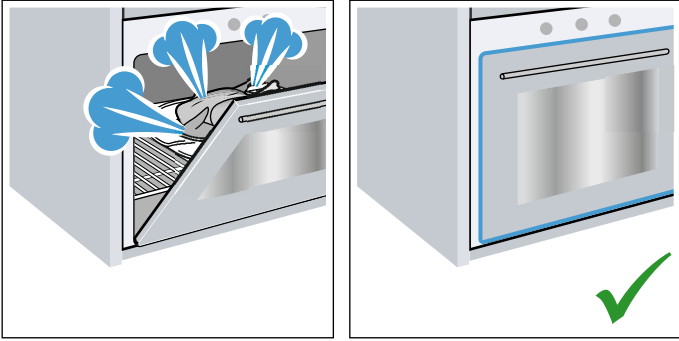

- It is best to bake several cakes one after the other. The cooking compartment stays warm. This reduces the baking time for the second cake. You can place two cake tins next to each other in the cooking compartment.

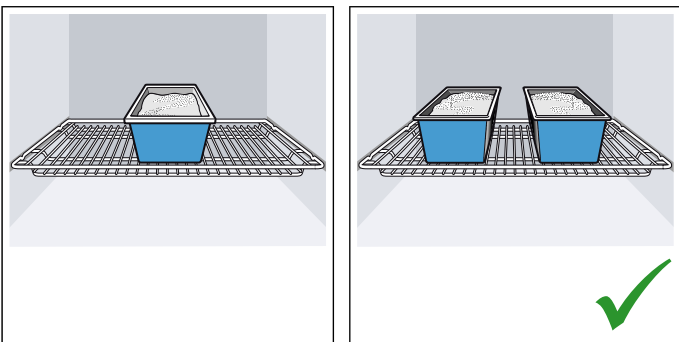

- For longer cooking times, you can switch the appliance off 10 minutes before the end of the cooking time and use the residual heat to finish cooking.

Environmentally-friendly disposal

Dispose of packaging in an environmentally-friendly manner.



This appliance is labelled in accordance with European Directive 2012/19/EU concerning used electrical and electronic appliances (waste electrical and electronic equipment - WEEE). The guideline determines the framework for the return and recycling of used appliances as applicable throughout the EU.

Getting to know your appliance

In this section, we will explain the indicators and controls. You will also find out about the various functions of your appliance.

Note: Depending on the appliance model, individual details and colours may differ.



- 1 Buttons and display**
The buttons are touch keys with sensors underneath. Simply touch a symbol to select the function.
The display shows symbols for active functions and the time-setting options.
- 2 Main oven**
Controls for the main oven
- 3 Function selector**
Use the function selector to set the type of heating or other functions for the main oven.
You can turn the function selector clockwise or anti-clockwise from the "Off" position.
- 4 Temperature selector**
Use the temperature selector to set the temperature for the type of heating or select the setting for other functions for the main oven.
You can only turn the temperature selector clockwise from the "Off" position, until it offers resistance. Do not turn the selector beyond this point.
- 5 Heating-up indicator**
The heating-up indicator for the main oven remains lit while the appliance is heating.
- 6 Top oven**
Controls for the top oven
- 7 Function selector**
Use the function selector to set the type of heating or other functions for the top oven.
You can turn the function selector clockwise or anti-clockwise from the "Off" position.

Control panel

You can set your appliance's various functions on the control panel. Below, you will see an overview of the control panel and the layout of the controls.

- 8 Temperature selector**
Use the temperature selector to set the temperature for the type of heating or select the setting for other functions for the top oven.
You can only turn the temperature selector clockwise from the "Off" position, until it offers resistance. Do not turn the selector beyond this point.
- 9 Heating-up indicator**
The heating-up indicator for the top oven remains lit while the appliance is heating.

Note: On some appliances, the control knobs can be pushed in. To push the control knob in and engage it or to release it again, turn it to the "Off" position.

Buttons and display

You can use the buttons to set various additional functions on your appliance. You will be able to see the values for these on the display.

Symbol	Meaning
🕒	Time-setting options Tap the symbol repeatedly to select the time 🕒, timer ⌚, duration → and end time → .
<	Minus Reduce setting values.
>	Plus Increase setting values.

Display

The value that can be set immediately or that is elapsing is shown in large digits in the display.











To use the individual time-setting options, tap the  button several times. If there is a red bar above or below a symbol, this means that the value being shown in large digits on the display refers to the function that this symbol represents.

Types of heating and functions

Use the function selector to set the types of heating and other functions.



To make sure you always use the right type of heating to cook your food, we have explained the differences and applications below.



Note: Not all heating functions and other functions are available for both ovens. To find out which ones are available, see the symbols on the controls.

Type of heating	Use	
	Main oven	
	CircoTherm	For baking and cooking on one or more levels. The fan distributes the heat from the ring-shaped heating element in the back wall evenly around the cooking compartment.
	CircoTherm gentle	For gently cooking selected types of food on one level without preheating. The fan distributes the heat from the ring-shaped heating element in the back panel around the cooking compartment. This heating function is used to measure both the energy consumption in air recirculation mode and the energy efficiency class.
	Grill, large area	For grilling flat items, such as steaks or sausages, for making toast, and for au gratin dishes. The whole area below the grill element becomes hot.
	Circo-roasting	For roasting poultry, whole fish and larger pieces of meat. The grill heating element and the fan switch on and off alternately. The fan circulates the hot air around the food.
	Top/bottom heating	For traditional baking and roasting on one level. Especially suitable for cakes with moist toppings. Heat is emitted evenly from above and below. This type of heating is used to measure the energy consumption in the conventional mode.
	Top oven	
	Top/bottom heating	For baking on one level. Heat is emitted evenly from above and below. This type of heating is used to measure the energy consumption in the conventional mode.
	Centre-area grill	For grilling small amounts of steak or sausages, for making toast, and for browning food. The centre area under the grill heating element becomes hot.
	Grill, large area	For grilling flat items, such as steaks or sausages, for making toast, and for au gratin dishes. The whole area below the grill element becomes hot.

Other functions

Your new oven has yet more functions; see below for a brief description of these.

Function	Use	
	Bottom oven	
	Rapid heat-up	Preheats the cooking compartment rapidly without accessories inside it.
	Interior lighting	Switches on the interior lighting; all other functions remain off. Makes it easier to clean the cooking compartment, for example.

	Top oven	
	Interior lighting	Switches on the interior lighting; all other functions remain off. Makes it easier to clean the cooking compartment, for example.

Temperature

Use the temperature selector to set the temperature in the cooking compartment. You can also use it to select the settings for other functions.

For temperature settings above 250 °C, the appliance reduces the temperature to approx. 240 °C after approx. 10 minutes. If your appliance has the top/bottom heating or bottom heating types, this reduction does not take place.

Position		Meaning
●	"Off" position	The appliance is not heating.
50-270	Temperature range	The temperature that can be set in the cooking compartment in °C.
~	Grill, intensive	The maximum adjustable temperature for the "Grill, large area" or "Grill, small area" types of heating (depending on the appliance type).

Cooking compartment

Various functions in the cooking compartment make your appliance easier to use. For example, the cooking compartment is well lit and a cooling fan prevents the appliance from overheating.

Opening the appliance door

If you open the appliance door when the appliance is in operation, the appliance will continue to operate as before.

Interior lighting

With most heating functions and other functions, the interior lighting in the cooking compartment will remain lit while the oven is in operation. When the function selector is turned to bring operation to an end, the lighting will go out.

By turning the function selector to the interior lighting setting, you can switch on the lighting without heating the oven. This makes it easier to clean your appliance, for example.

Cooling fan

The cooling fan switches on and off as required. The hot air escapes above the door.

Caution!

Do not cover the ventilation slots. Otherwise, the appliance may overheat.

So that the cooking compartment cools down more quickly after operation, the cooling fan continues to run for a certain period afterwards.

Accessories

Your appliance is accompanied by a range of accessories. Here, you can find an overview of the accessories included and information on how to use them correctly.

Control accessories

The accessories supplied may differ depending on the appliance model.

	<p>Wire rack For ovenware, cake tins and ovenproof dishes. For roasts, grilled items and frozen meals.</p>
	<p>Universal pan For moist cakes, pastries, frozen meals and large roasts. It can be used to catch dripping fat when you are grilling directly on the wire rack.</p>

Only use original accessories. They are specially adapted for your appliance.

You can buy accessories from the after-sales service, from specialist retailers or online.

Note: The accessories may deform when they become hot. This does not affect their function. Once they have cooled down again, they regain their original shape.

Inserting accessories

The shelf positions are counted from the bottom up.

The bottom cooking compartment

The bottom cooking compartment has three shelf positions.

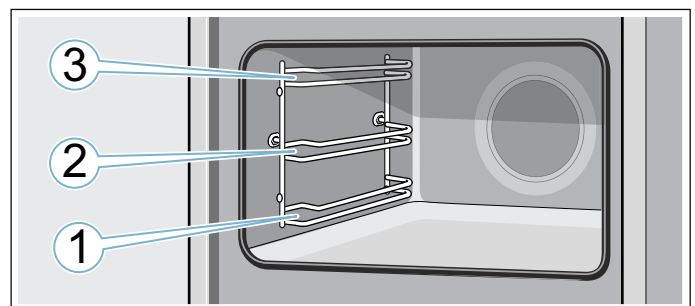

Always insert accessories between the two guide rods for the shelf position.

Accessories can be pulled out approximately halfway without tipping.

Notes

- Make sure that you always insert the accessories into the cooking compartment the right way round.
- Always insert the accessories fully into the cooking compartment so that they do not touch the appliance door.
- Take any accessories that you will not be using out of the cooking compartment.
- The shelf supports can be taken out of the cooking compartment for cleaning. → Page 17

The top cooking compartment

The top cooking compartment has three shelf positions.

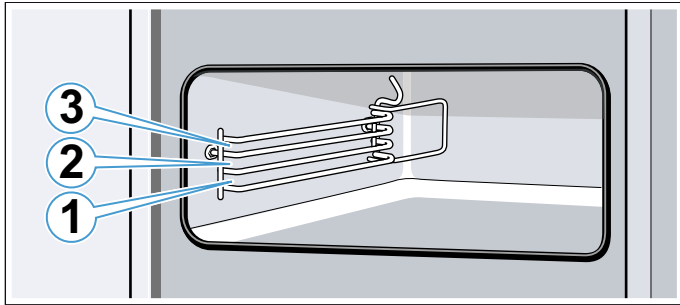

Always insert accessories between the two guide rods for the shelf position.

Accessories can be pulled out approximately halfway without tipping.

Notes

- Make sure that you always insert the accessories into the cooking compartment the right way round.
- Always insert the accessories fully into the cooking compartment so that they do not touch the appliance door.
- Take any accessories that you will not be using out of the cooking compartment.

Locking function

The accessories can be pulled out approximately halfway until they lock in place. The locking function prevents the accessories from tilting when they are pulled out. The accessories must be inserted into the cooking compartment correctly for the tilt protection to work properly.

When inserting the wire rack, ensure that lug **a** is at the rear and is facing downwards. The open side must be facing the appliance door and the outer rail must be facing downwards ↘.

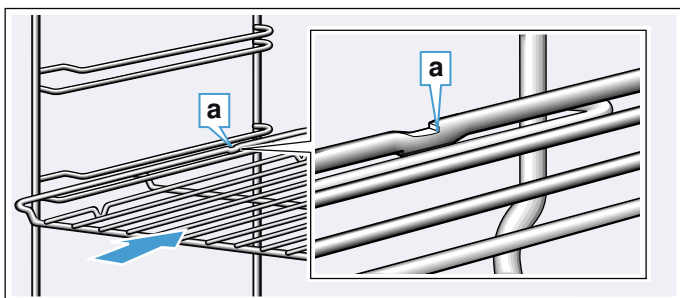

When inserting baking trays, make sure that the recess **a** is at the rear and is facing downwards. The sloping edge of the accessory **b** must be facing towards the appliance door.

Example in the picture: Universal pan

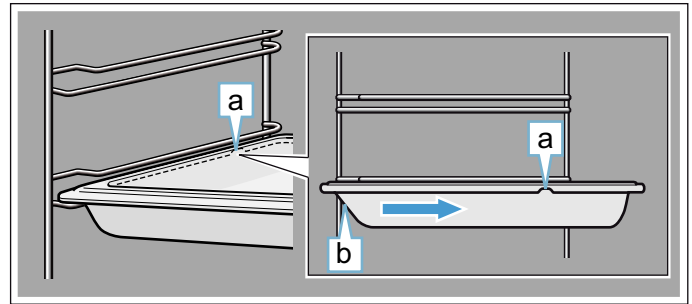

Combining accessories

You can insert the wire rack and the universal pan at the same time to catch drops of liquid.

When inserting the wire rack, ensure that both spacers **a** are at the rear edge. When inserting the universal pan, the wire rack is on top of the upper guide rod of the shelf position.

Example in the picture: Universal pan

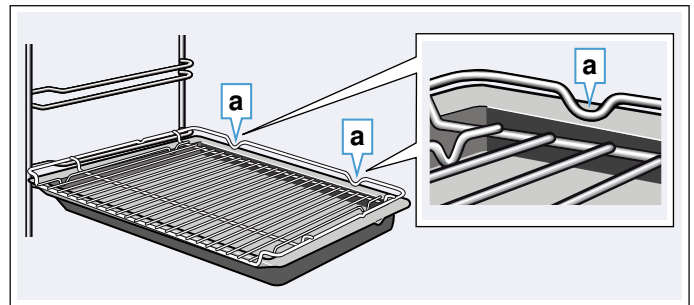

Optional accessories

You can purchase optional accessories from the after-sales service and specialist retailers, or on the Internet. You will find a comprehensive range of products for your appliance in our brochures and on the Internet.

Both availability and whether it is possible to order online differ between countries. Please see your sales documents for more details.

Note: Not all optional accessories are suitable for every appliance. When purchasing, please always quote the exact designation (E no.) of your appliance.

→ "Customer service" on page 23

Accessories

Baking and roasting shelf
Baking tray
Universal pan
Baking tray, non-stick
Universal pan, non-stick
Extra-deep pan
Steaming set for ovens
Profi pan
Lid for the Profi pan
Pizza tray
Grill tray

Ceramic brick
Glass roasting dish, 5.1 litres
Glass pan
ComfortFlex rail (1 level)*
3 x fully extendable pull-out rack*
*Accessory does not fit in every appliance, quote the E no. when ordering

Before using for the first time

Before you can use your new appliance, you must make some settings. You must also clean the cooking compartment and accessories.

Initial use

The time will appear on the display once the appliance is connected to the power supply. Set the current time.

Setting the time on the clock

Make sure that the function selector is set to the "Off" position.

The time starts at "12:00".





1. Use the < or > button to set the time.
2. Touch the ⌚ button to confirm.

The current time will be shown on the display.

Cleaning the cooking compartment

To eliminate the new-appliance smell, heat up the cooking compartment without anything in it and with the oven door closed.

1. Remove the accessories from the cooking compartment.
2. Remove any leftover packaging, such as polystyrene pellets, from the cooking compartment.
3. Before heating the appliance, wipe the smooth surfaces in the cooking compartment with a soft, damp cloth.
4. Set the specified type of heating and temperature.

Settings	Bottom oven 	Top oven 
Type of heating	CircoTherm 	Top/bottom heating 
Temperature	Maximum	240 °C
Cooking time	1 hour	1 hour

5. Keep the kitchen ventilated while the appliance is heating.
6. Switch off the appliance after the specified cooking time.
7. Wait until the cooking compartment has cooled down.
8. Clean the smooth surfaces with soapy water and a dish cloth.

Cleaning the accessories

Clean the accessories thoroughly using soapy water and a dish cloth or soft brush.

Operating the appliance

You have already learnt about the controls and how they work. Now we will explain how to apply settings on your appliance.

Switching the appliance on and off

Use the function selector to switch the appliance on or off. Turning the function selector to any position other than the "Off" position switches on the appliance. To switch off the appliance, always turn the function selector to the "Off" position.

Setting the heating function and temperature

It is very easy to apply the settings you require to your appliance using the function and temperature selector. To find out which heating function is best for which type of food, please refer to the beginning of the instruction manual. → "Getting to know your appliance" on page 8

Example in the picture: CircoTherm hot air  at 160 °C.

1. Use the function selector to set the heating function.
2. Use the temperature selector to set the temperature or grill setting.

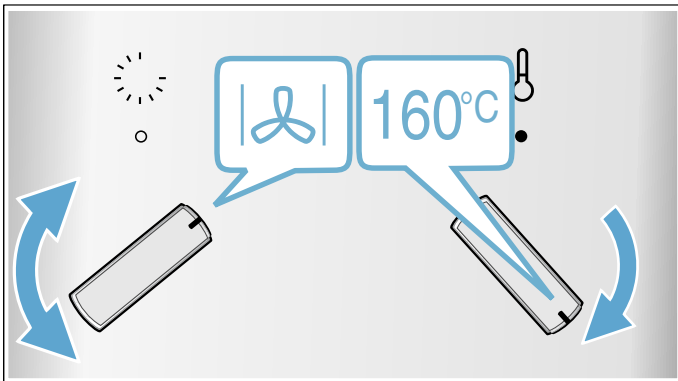

The appliance will start heating after a few seconds.

Once your food is cooked, turn the function selector to the "Off" position to switch the appliance off.

Note: You can also set a cooking time and end time on the appliance. → "Time-setting options" on page 14

Changing

The heating function and temperature can be changed at any time using the relevant selector.

Heating-up indicator

The heating-up indicator will remain lit while the appliance is heating.

When you are preheating the appliance, the optimal time to place your food in the cooking compartment is when the heating-up indicator first goes out.



Note: Due to thermal inertia, the actual temperature inside the cooking compartment may differ slightly from the temperature that is displayed.

Rapid heating

With Rapid heating, you can shorten the heat-up time.







Only use rapid heating when a temperature of over 100 °C has been selected.

To achieve an even cooking result, do not place your food into the cooking compartment until rapid heating is complete.

1. Set the function selector to .
2. Use the temperature selector to set a temperature of above 100 °C.
The oven starts to heat up after a few seconds. The  symbol appears in the display.
3. Wait until a signal sounds and the  symbol goes out.
The rapid heating has ended.
4. Place the meal in the cooking compartment.
5. Set the type of heating.

Time-setting options

Your appliance has different time-setting options.

Time-setting option	Use
 Timer	The timer functions like an egg timer. It runs independently of the appliance when it is heating and does not affect the appliance.
 Cooking time	Main oven  : Once the set cooking time has elapsed, the appliance automatically stops heating.
 End	Main oven  : Enter a cooking time and the required end time. The appliance starts up automatically so that it finishes cooking at the required time.
 Time	Set the time on the clock, e.g. after a power cut, or change it, e.g. from summer time to winter time.

An audible signal sounds once the cooking time or timer duration has elapsed. You can cancel the audible signal early by pressing the  button.

Note: If you have set a time-setting option, the time interval increases if you set a higher value. Example: You can set a cooking time of up to one hour in one-minute increments; for cooking times over one hour, you can set a cooking time in five-minute increments.





Setting the timer

The timer can be set when the appliance is switched on or off. It has its own audible signal so that you can tell whether it is the timer duration or a cooking time that has elapsed.

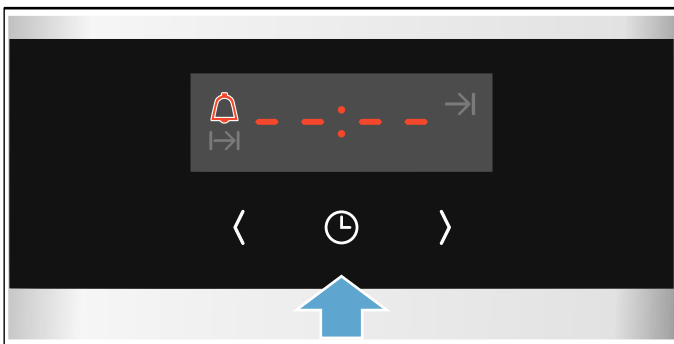
Tip: If the set timer duration is the duration for which you want to cook your food, use the cooking time. The appliance then switches off automatically.

1. Press the  button repeatedly until the  symbol is highlighted.



2. Use the  and  buttons to set the timer duration.
 - Default value for the  button = 5 minutes
 - Default value for the  button = 10 minutes

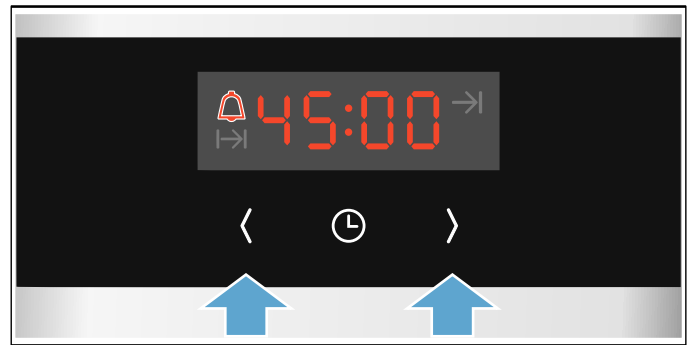







The setting is applied automatically. After a few seconds, the timer duration will start to count down.

Note: Once the set time has elapsed, an audible signal will sound. To stop the timer, press the  button.

Setting the cooking time

Once the set cooking time has elapsed, the appliance switches off automatically. The function can only be used in combination with a type of heating.

1. Set the heating type and temperature for the main oven .
2. Press the  button repeatedly until the  symbol is highlighted.
3. Use the  and  buttons to set the cooking time.
 - Default value for the  button = 10 minutes
 - Default value for the  button = 30 minutes
 The setting is applied automatically. The appliance starts to heat after a few seconds. The cooking time counts down in the display.





Once the cooking time has elapsed, an audible signal sounds and the appliance brings the operating mode to an end automatically.

To switch off, turn the function selector back to the "Off" position.

Setting the end time

You can delay the time at which cooking is due to finish. You can, for example, put your food in the cooking compartment in the morning and set the cooking time so that it is ready at lunch time.

Notes

- Ensure that food is not left in the cooking compartment for too long as it may spoil.
 - Do not adjust the end time once the appliance is already in operation. Otherwise the cooking result would no longer be satisfactory.
1. Place the food onto the appropriate accessory in the cooking compartment and close the appliance door.
 2. Set the heating type and temperature for the main oven .
 3. Press the  button repeatedly until the  symbol is highlighted.
 4. Use the  and  buttons to set the cooking time.



5. Press the  button repeatedly until the →| symbol is highlighted.
6. Use the < and > buttons to set the end time. After a few seconds, the appliance will apply the settings. The end time is shown in the display. Once the appliance starts, the cooking time begins counting down.

As soon as the end time has been reached, an audible signal sounds and the appliance ends the operation automatically.

To switch off, turn the function selector back to the "Off" position.

Setting the time

You can only change the time when no other time-setting option is active and the function selector is at the "Off" position.

1. Press the  button repeatedly until the  symbol is selected.
2. Use the < or > button to change the time. The appliance applies the time after a few seconds.

Checking, changing or deleting settings

1. Press the  button repeatedly until the appropriate symbol is selected.
2. If required, use the < or > button to change the setting. To delete a time-setting option, set **00:00**. The setting is applied automatically.

Childproof lock

The bottom oven has a childproof lock to prevent children from switching it on or changing settings by accident.

Notes

- If a hob is connected, it will not be affected by the childproof lock on the oven.
- After a power cut, the childproof lock will no longer be active.

Activating and deactivating

To activate the childproof lock for the main oven, the function selector must be set to the "Off" position.

Press and hold the  button for approx. four seconds.

SAFE appears in the display. The childproof lock is now active for the main oven.

Note: If a timer duration  has been set, this continues to count down. While the childproof lock is active, the timer duration cannot be changed.

To deactivate the childproof lock, press and hold the  button again for approx. four seconds until **SAFE** goes out in the display.

Cleaning

With good care and cleaning, your appliance will retain its appearance and remain fully functioning for a long time to come. We will explain here how you should correctly care for and clean your appliance.

Suitable cleaning agents

To ensure that the different surfaces are not damaged by using the wrong cleaning agent, observe the information in the table. Depending on the appliance model, not all of the areas listed may be on/in your appliance.

Caution!

Risk of surface damage

Do not use:

- Harsh or abrasive cleaning agents,
- Cleaning agents with a high alcohol content,
- Hard scouring pads or cleaning sponges,
- High-pressure cleaners or steam cleaners,
- Special cleaners for cleaning the appliance while it is hot.

Wash new sponge cloths thoroughly before use.

Tip: Highly recommended cleaning and care products can be purchased through the after-sales service. Observe the respective manufacturer's instructions.

Warning – Risk of burns!

The appliance becomes very hot. Never touch the interior surfaces of the cooking compartment or the heating elements. Always allow the appliance to cool down. Keep children at a safe distance.

Area	Cleaning
Appliance exterior	
Stainless steel front	Hot soapy water: Clean with a dish cloth and then dry with a soft cloth. Remove flecks of limescale, grease, starch and albumin (e.g. egg white) immediately. Corrosion can form under such flecks. Special stainless steel cleaning products suitable for hot surfaces are available from our after-sales service or from specialist retailers. Apply a very thin layer of the cleaning product with a soft cloth.
Plastic	Hot soapy water: Clean with a dish cloth and then dry with a soft cloth. Do not use glass cleaner or a glass scraper.
Painted surfaces	Hot soapy water: Clean with a dish cloth and then dry with a soft cloth.
Control panel	Hot soapy water: Clean with a dish cloth and then dry with a soft cloth. Do not use glass cleaner or a glass scraper.

Door panels	Hot soapy water: Clean with a dish cloth and then dry with a soft cloth. Do not use a glass scraper or a stainless steel scouring pad.
Door handle	Hot soapy water: Clean with a dish cloth and then dry with a soft cloth. If descaler comes into contact with the door handle, wipe it off immediately. Otherwise, any stains will not be able to be removed.
Appliance interior	
Enamelled surfaces	Hot soapy water or a vinegar solution: Clean with a dish cloth and then dry with a soft cloth. Soften baked-on food remnants with a damp cloth and soapy water. Use stainless steel wire wool or oven cleaner to remove stubborn dirt. Caution! Never use oven cleaner in the cooking compartment when it is still warm. This may damage the enamel. Remove all food remnants from the cooking compartment and the appliance door before you next heat up the appliance. Leave the cooking compartment open to dry after cleaning it. Note: Food residues can cause white deposits to form. These are harmless and do not affect how the appliance works. Remove using lemon juice if required.
Glass cover for the interior lighting	Hot soapy water: Clean with a dish cloth and then dry with a soft cloth. If the cooking compartment is heavily soiled, use oven cleaner.
Door seal	Hot soapy water: Clean with a dish cloth. Do not scour.
Door cover	made from stainless steel: Use stainless steel cleaner. Follow the manufacturers' instructions. Do not use stainless steel care products. made from plastic: Clean using hot soapy water and a dish cloth. Dry with a soft cloth. Do not use glass cleaner or a glass scraper. Remove the door cover for cleaning.
Rails	Hot soapy water: Soak and clean with a dish cloth or brush.
Pull-out system	Hot soapy water: Clean with a dish cloth or a brush. Do not remove the lubricant while the pull-out rails are pulled out – it is best to clean them when they are pushed in. Do not clean in the dishwasher.
Accessories	Hot soapy water: Soak and clean with a dish cloth or brush. If there are heavy deposits of dirt, use a stainless steel scouring pad.

Notes

- Slight differences in colour on the front of the appliance are caused by the use of different materials, such as glass, plastic and metal.
- Shadows on the door panels, which look like streaks, are caused by reflections made by the interior lighting.
- Enamel is baked on at very high temperatures. This can cause some slight colour variation. This is normal and does not affect operation. The edges of thin trays cannot be completely enamelled. As a result, these edges can be rough. This does not impair the anti-corrosion protection.

Keeping the appliance clean

Always keep the appliance clean and remove dirt immediately so that stubborn deposits of dirt do not build up.

⚠ Warning – Risk of fire!

Loose food remnants, fat and meat juices may catch fire. Before using the appliance, remove the worst of the food remnants from the cooking compartment, heating elements and accessories.

Tips

- Clean the cooking compartment after each use. This will ensure that dirt cannot be baked on.
- Always remove flecks of limescale, grease, starch and albumin (e.g. egg white) immediately.
- Use the universal pan for baking very moist cakes.
- Use suitable ovenware for roasting, e.g. a roasting dish.

🔧 Rails

With good care and cleaning, your appliance will retain its appearance and remain fully functional for a long time to come. This will tell you how to remove the shelves and clean them.

Detaching and refitting the rails

⚠ Warning – Risk of burns!

The rails become very hot. Never touch the hot rails. Always allow the appliance to cool down. Keep children away from the appliance.

Detaching the rails

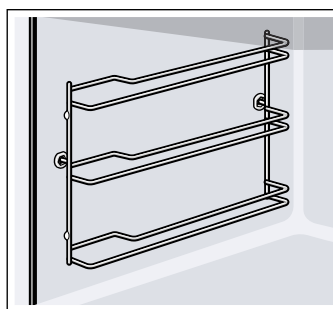

1. Lift the rail slightly at the front **a** and detach it **b** (figure **1**).
2. Then pull the whole rail towards you and take it out (figure **2**).

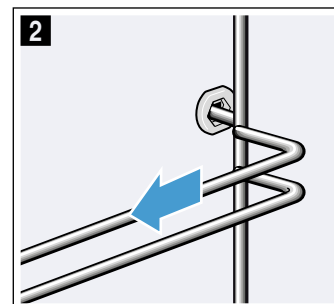
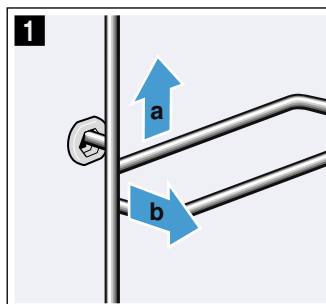

Clean the rails with cleaning agent and a sponge. For stubborn deposits of dirt, use a brush.

Attaching the rails

The rails only fit on the right or the left side. For both rails, ensure that the curved rods are at the front.

1. First, insert the rail in the middle of the rear socket **a**, until the rail rests against the cooking compartment wall, and push it back **b** (figure **1**).
2. Then insert the rail into the front socket **c**, until the rail also rests against the cooking compartment wall here, and press it downwards **d** (figure **2**).

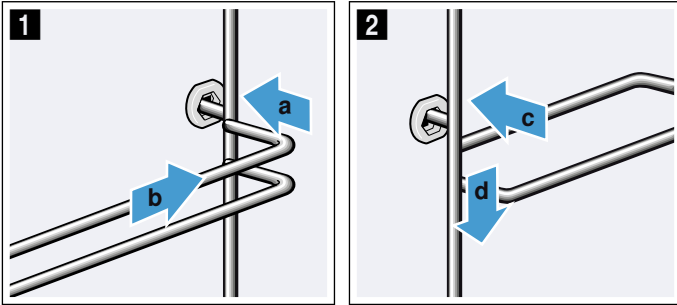

Detaching and refitting the rails

⚠ Warning – Risk of burns!

The rails become very hot. Never touch the hot rails. Always allow the appliance to cool down. Keep children away from the appliance.

Detaching the shelf supports

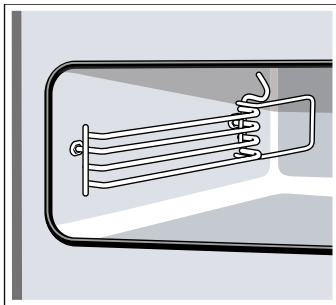

1. Lift the shelf support slightly at the front **a** and detach it **b** (fig. **1**).
2. Then pull the whole shelf support towards you and remove it (fig. **2**).

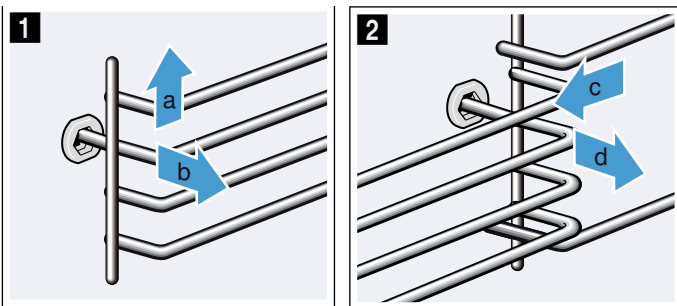

Clean the shelf supports with washing-up liquid and a sponge. For stubborn dirt deposits, use a brush.

Refitting the shelf supports

The shelf supports are designed to fit on either the right- or the left-hand side (not both). For each of the shelf supports, make sure that the hooks at the back are at the top.

1. First, push the shelf support into the middle of the rear socket **a** until the shelf support rests against the cooking compartment wall, and then push it back **b** (fig. **1**).
2. Then push the shelf support into the front socket **c** until the shelf support also rests against the cooking compartment wall, and then press it downwards **d** (fig. **2**).

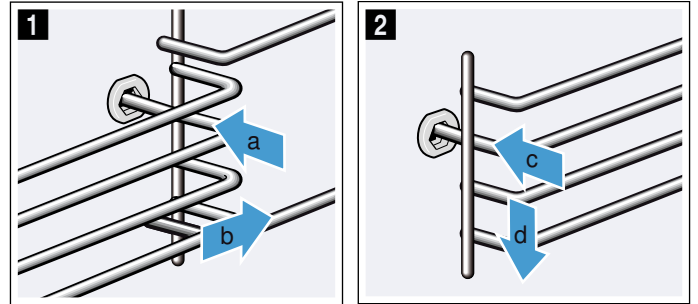

Appliance door

With good care and cleaning, your appliance will retain its appearance and remain fully functional for a long time to come. This will tell you how to clean the appliance door.

Main oven – Fitting and removing the glass panels

To facilitate cleaning, you can remove the glass panels from the appliance door.

Locking the appliance door

1. Open the appliance door fully.
2. Open the two locking levers on the left and right (fig. 1).
3. Close the appliance door as far as it goes (fig. 2).

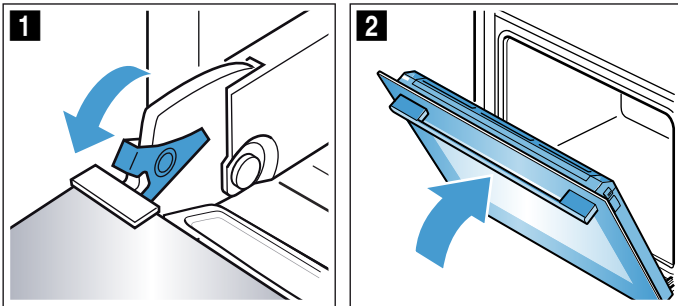

Removing panels

1. Press the left- and right-hand sides of the cover (fig. 1).
2. Remove the cover (fig. 2).

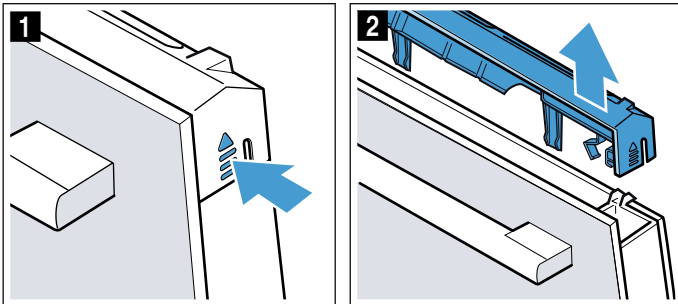

3. Lift out each panel (fig. 3) and set them down carefully on a flat surface.
4. If necessary, you can remove the condensate trough for cleaning. To do this, open the appliance door fully (fig. 4).

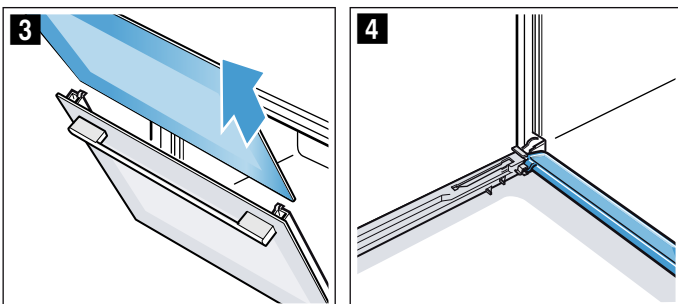

5. Tilt the condensate trough up and remove it (fig. 5).

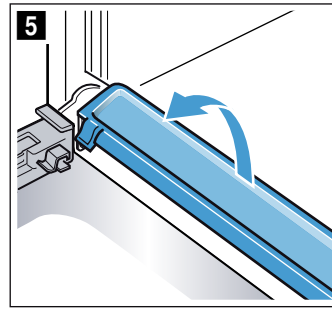

Clean the panels with glass cleaner and a soft cloth. Wipe the condensate trough with a cloth and some hot soapy water.

Warning

Risk of injury!

- Scratched glass in the appliance door may develop into a crack. Do not use a glass scraper, sharp or abrasive cleaning aids or detergents.
- The hinges on the appliance door move when opening and closing the door, and you may be trapped. Keep your hands away from the hinges.

Fitting panels

1. Open the appliance door fully and refit the condensate trough. To do this, insert the trough from above and rotate it at the bottom (fig. 1).

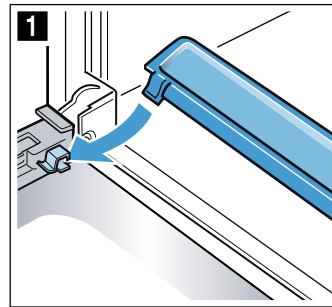

2. Close the appliance door fully.
3. Slide each panel back in and make sure that it is sitting correctly at the bottom in the retainer (fig. 2).

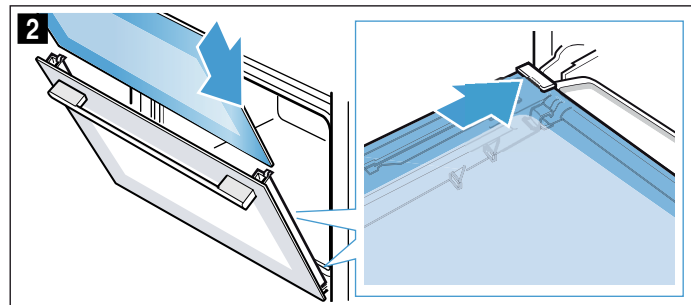

4. Push each panel in at the top (fig. 3).

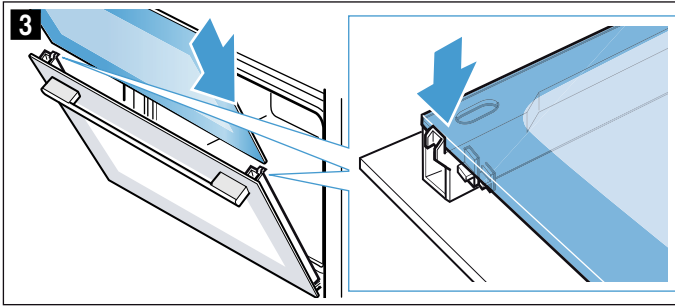

5. Put the cover back in place and press on it until you hear it click into place (fig. 4).

6. Open the appliance door again fully.

7. Close the two locking levers on the left and right (fig. 5).

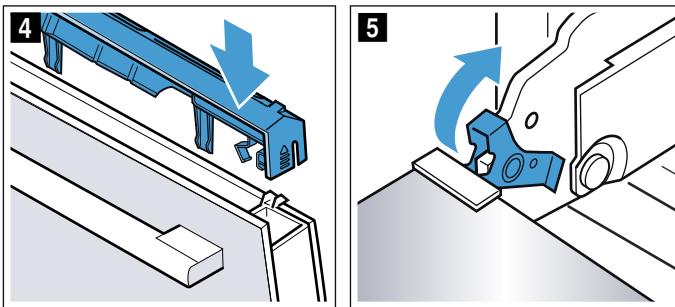

8. Close the appliance door.

Caution!

Do not use the cooking compartment again until the panels have been correctly fitted.

Top oven – Fitting and removing the glass panels

To facilitate cleaning, you can remove the glass panels from the appliance door.

The appliance door hinges each have a locking lever. When the locking levers are closed (fig. 1), the appliance door is secured in place. It cannot be detached.

When the locking levers are open in order to detach the appliance door (fig. 2), the hinges are locked. They cannot snap shut.

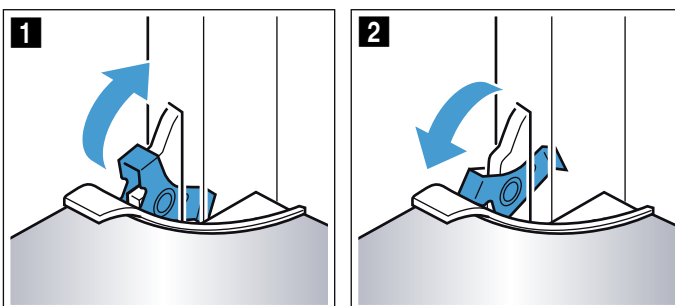

Warning
Risk of injury!

- If the hinges are not locked, they can snap shut with great force. Ensure that the locking levers are always fully closed or, when detaching the appliance door, fully open.
- The hinges on the appliance door move when opening and closing the door, and you may be trapped. Keep your hands away from the hinges.

Removing panels

1. Open the appliance door fully.
2. Open the two locking levers on the left and right (fig. 1).
3. Close the appliance door fully **a**. Take hold of the appliance door with both hands, one on the left and one on the right **b**, and pull it up and out (fig. 2).

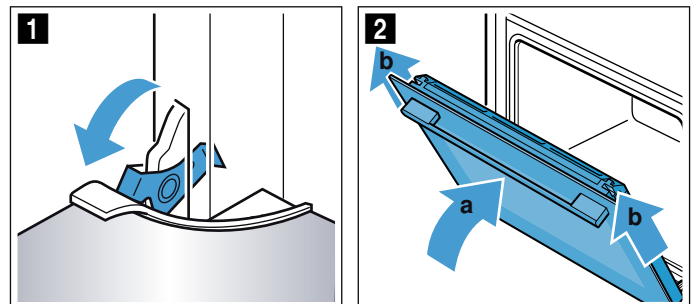

4. Set the appliance door down carefully on a level surface.
5. Press the left- and right-hand sides of the cover (fig. 3).
6. Remove the cover (fig. 4).

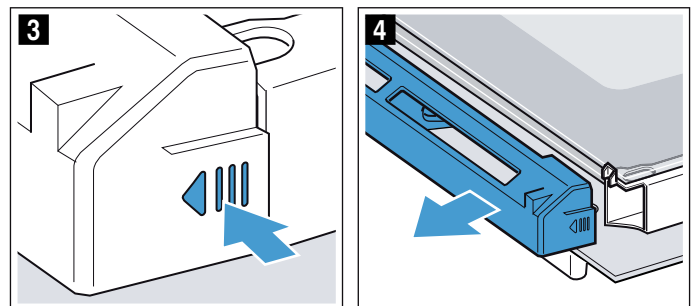

7. Lift out the outer panel (fig. 5) and set it down carefully on a flat surface.
8. Lift out the inner panel (fig. 6) and set it down carefully on a flat surface.

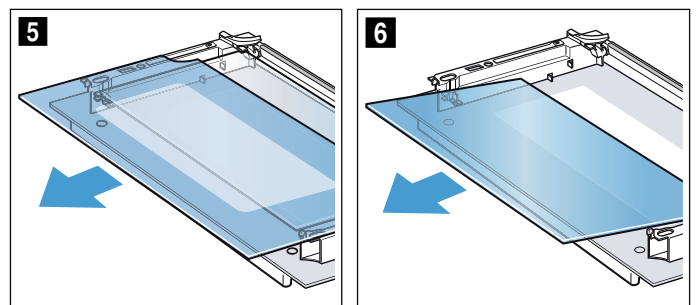

Clean the panels with glass cleaner and a soft cloth.

⚠ Warning**Risk of injury!**

- Scratched glass in the appliance door may develop into a crack. Do not use a glass scraper, sharp or abrasive cleaning aids or detergents.
- The hinges on the appliance door move when opening and closing the door, and you may be trapped. Keep your hands away from the hinges.

Fitting panels

1. Slide each inner panel back in and make sure that the number on the inner panel is to the bottom right (fig. 1).
2. Ensure that the inner panel is in the bottom right of the retainer (fig. 2).

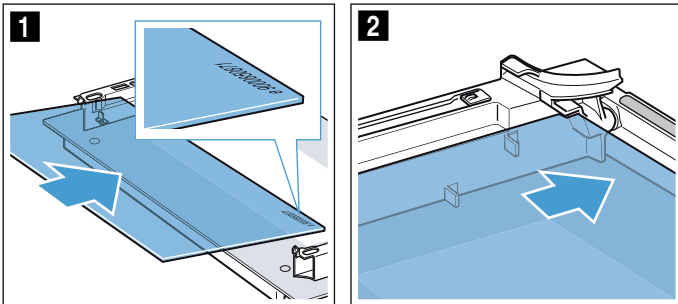

3. Push the inner panel in at the top (fig. 3).

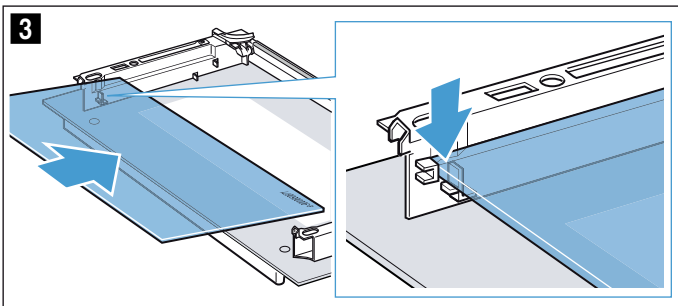

4. Place the outer disc on the seal **a** (Fig. 4).

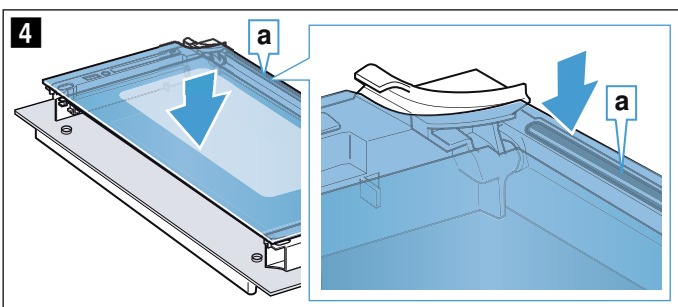

5. Slide the outer panel back in and make sure that it is sitting correctly at the bottom in the retainer (fig. 5).

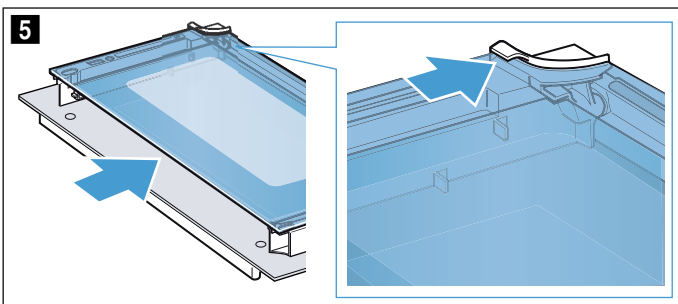

6. Push the outer panel in at the top (fig. 6).

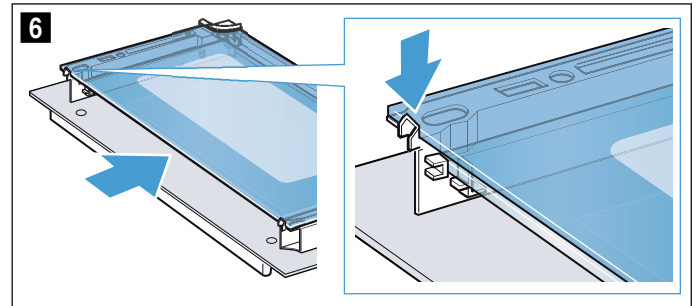

7. Put the cover back in place and press on it until you hear it click into place (fig. 7).

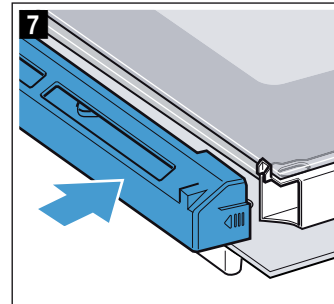

8. When fitting the appliance door, ensure that both hinges are inserted straight into the opening (fig. 8). Place both hinges at the bottom on the outer panel and use them as a guide. Ensure that the hinges are inserted into the correct opening. You must be able to insert them easily and without resistance. If you can feel any resistance, check that the hinges are inserted into the correct opening.

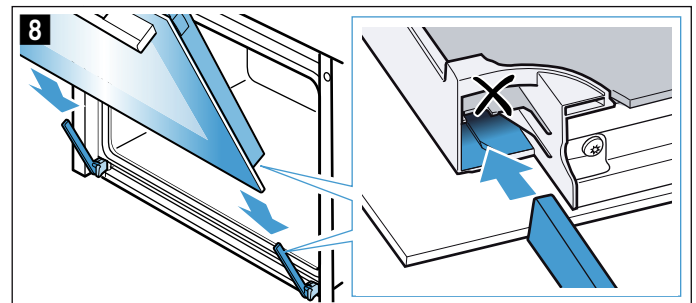

9. Open the appliance door fully.
10. Close the two locking levers on the left and right (fig. 9).

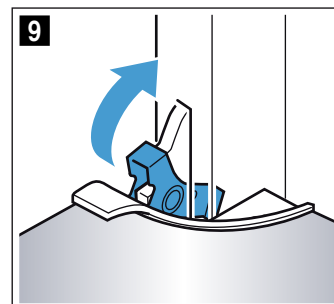

11. Close the appliance door.

Caution!

Do not use the cooking compartment again until the panels have been correctly fitted.

Trouble shooting

If a fault occurs, there is often a simple explanation. Before calling the after-sales service, please refer to the fault table and attempt to correct the fault yourself.

Rectifying faults yourself

You can often easily rectify technical faults with the appliance yourself.

If a dish does not turn out exactly as you wanted, you can find useful cooking tips and instructions at the end of this instruction manual. → "Tested for you in our cooking studio" on page 23

Fault	Possible cause	Notes/remedy
The appliance is not working.	Defective circuit breaker.	Check the circuit breaker in the fuse box.
	Power failure	Check whether the kitchen light or other kitchen appliances are working.
The time is flashing on the display.	Power failure.	Reset the time.
No settings can be made on the appliance. A key symbol or SAFE lights up on the display.	The childproof lock is activated.	Deactivate the childproof lock by pressing and holding the  button for approx. 4 seconds.

Warning – Risk of injury!

Incorrect repairs are dangerous. Do not attempt to repair the appliance yourself. Repairs must only be carried out by one of our trained after-sales engineers. If the appliance is defective, call the after-sales service.

Warning – Risk of electric shock!

Incorrect repairs are dangerous. Repairs may only be carried out and damaged power cables replaced by one of our trained after-sales technicians. If the appliance is defective, unplug the appliance from the mains or switch off the circuit breaker in the fuse box. Contact the after-sales service.

Error messages on the display

If an error message with "E" appears on the display, e.g. **E05-32**, touch the  button. This will reset the error message. Reset the time, if necessary.

If the fault was a one-off, you can continue to use your appliance as normal. If the error message appears again, call our after-sales service and quote the exact error message and the E no. of your appliance.

→ "Customer service" on page 23

Replacing the bulb in the top of the cooking compartment

If the cooking compartment light bulb fails, it must be replaced. Heat-resistant, 25 watt, 230 V halogen bulbs are available from the after-sales service or specialist retailers.

When handling the halogen bulb, use a dry cloth. This will increase the service life of the bulb. Only use these bulbs.

Warning – Risk of electric shock!

When replacing the cooking compartment bulb, the bulb socket contacts are live. Before replacing the bulb, unplug the appliance from the mains or switch off the circuit breaker in the fuse box.

Warning – Risk of burns!

The appliance becomes very hot. Never touch the interior surfaces of the cooking compartment or the heating elements. Always allow the appliance to cool down. Keep children at a safe distance.

1. Place a tea towel in the cold cooking compartment to prevent damage.
2. Turn the glass cover anti-clockwise to remove it (figure **1**).
3. Pull out the bulb – do not turn it (figure **2**). Insert the new bulb, making sure that the pins are in the correct position. Push the bulb in firmly.

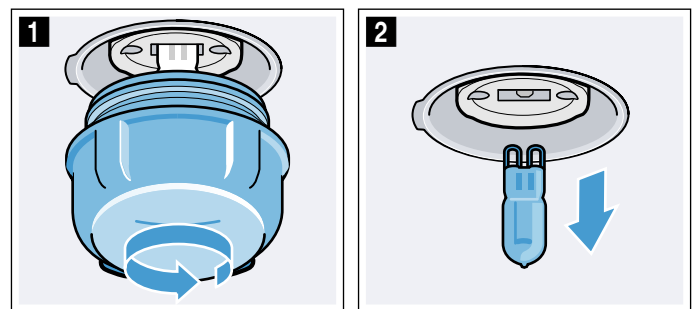

4. Screw the glass cover back on. Depending on the appliance model, the glass cover may have a sealing ring. If the glass cover has a sealing ring, put it back in place before screwing the cover back on.
5. Remove the tea towel and switch on the circuit breaker.

Customer service

Our after-sales service is there for you if your appliance needs to be repaired. We will always find an appropriate solution, also in order to avoid after-sales personnel having to make unnecessary visits.

E number and FD number

When calling us, please give the full product number (E no.) and the production number (FD no.) so that we can provide you with the correct advice. The rating plate bearing these numbers can be found when you open the appliance door.

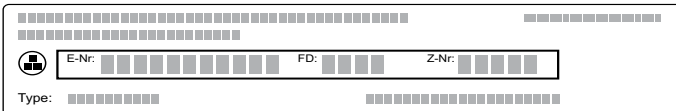

The diagram shows a rectangular rating plate with a grid of small squares. It contains the following fields: E-Nr. (with a grid of 12 squares), FD (with a grid of 6 squares), Z-Nr. (with a grid of 6 squares), and Type (with a grid of 12 squares). There is also a small icon of a telephone handset in the top left corner.

To save time, you can make a note of the number of your appliance and the telephone number of the after-sales service in the space below, should it be required.

E no.	FD no.
-------	--------

After-sales service 

Please note that a visit from an after-sales service engineer is not free of charge, even during the warranty period.

Please find the contact data of all countries in the enclosed customer service list.

To book an engineer visit and product advice

GB 0344 892 8989
Calls charged at local or mobile rate.

IE 01450 2655
0.03 € per minute at peak. Off peak 0.0088 € per minute.

Rely on the professionalism of the manufacturer. You can therefore be sure that the repair is carried out by trained service technicians who carry original spare parts for your appliances.

Tested for you in our cooking studio

Here, you can find a selection of dishes and the ideal settings for them. We will show you which type of heating and temperature are best suited to your dish. You will get information on suitable cooking accessories and the height at which they should be placed in the oven. You will also get tips about cookware and preparation methods.

Your oven consists of a main and top oven. There are separate tables for the different ovens. If there is only one table, this applies to the main oven. The shelf positions that are recommended in the text each refer to the main oven.

Note: A lot of steam can build up in the cooking compartment when cooking food.

Your appliance is very energy-efficient and radiates very little heat to its surroundings during operation. Due to the high difference in temperature between the appliance interior and the external parts of the appliance, condensation may build up on the door, control panel or adjacent kitchen cabinet panels. This is a normal physical phenomenon. Condensation can be reduced by preheating the oven or opening the door carefully.

Caution!

Never pour water into the hot cooking compartment or place cookware containing water onto the bottom of the cooking compartment. The change in temperature can cause damage to the enamel.

General information

Recommended setting values

The table lists the optimal heating type for various types of food. The temperature and cooking time are dependent on the quantity of food and the recipe. Settings ranges are indicated for this reason. Try using the lower values to start with. A lower temperature will result in more even browning. You can use a higher setting next time if necessary.

Note: Cooking times cannot be reduced by using higher temperatures. The food would only be cooked on the outside, but would not be fully baked in the middle.

The setting values apply to food that is placed into a cold cooking compartment. By doing so, you can make energy savings of up to 20 per cent. If you preheat the oven, you can reduce the indicated baking times by several minutes.

Preheating is necessary for selected food, and this is indicated in the table. Do not place your food or accessories into the cooking compartment until it has finished preheating.

If you wish to follow one of your own recipes when baking, you should use the setting values listed for similar food in the table as reference. Additional information can be found in the baking tips listed after the settings tables.

Remove unused accessories from the cooking compartment. This will ensure that you achieve the best possible cooking results and energy savings of up to 20 per cent.

Accessories

Only use original accessories supplied with your appliance. These have been tailored to the cooking compartment and the operating modes of your appliance.

Ensure that you always use suitable accessories and that they are placed in the oven the right way around.
→ "Accessories" on page 10

Greaseproof paper

Only use greaseproof paper that is suitable for the selected temperature. Always cut greaseproof paper to size.

CircoTherm gentle heating function

CircoTherm gentle is an intelligent heating function that allows you to gently cook meat, fish and baked items. The appliance optimally controls the supply of energy to the cooking compartment. The food is cooked in phases using residual heat. This means that it remains more succulent and browns less. Depending on the method of preparation and the type of food, it is possible to save energy. If you open the appliance door before the food has finished cooking or if you preheat the appliance, you may not be able to achieve this result.

Only use genuine accessories for your appliance. These have been tailored to the cooking compartment and the heating functions of your appliance. Remove any accessories that are not being used from the cooking compartment.

Baking in the main oven

Baking on one level

Food	Dish	Shelf position	Type of heating	Temperature in °C	Time in minutes
Victoria sponge cake	2x Ø20cm tins	1		150 - 160*	25 - 30
Light fruit cake	high Ø20cm tin	1		160 - 170	75 - 90
Rich fruit cake	high Ø23cm tin	1		140 - 150	180 - 210
Fruit crumble	flat glass dish	1		160 - 170	35 - 45
Sponge Cake (fatless), 3 eggs	springform cake tin Ø26cm	1		160 - 170*	25 - 35
Swiss roll	swiss roll tin	1		180 - 190*	12 - 18
Fruit Pie	plate Ø20cm or pie tin	2		180 - 190	60 - 70
Quiche	quiche tin (dark coated)	1		190 - 200	35 - 45
Quiche	quiche tin (dark coated)	1		200 - 210	35 - 45

* preheat; do not use rapid heat-up function
** preheat for 20 mins

Place the food into the empty cooking compartment before the oven is heated up. Select a temperature of between 120 °C and 230 °C. Always keep the appliance door closed when cooking. Only cook on one level when using this function.

The CircoTherm gentle heating function is used to measure both the energy consumption in air recirculation mode and the energy efficiency class.

Baking

Here, you can find recommended settings for many dishes.

In addition, refer to the information in the section on proving dough.

Baking on one level

When baking on one level, use the following shelf positions:

- Tall baked goods or tin on wire rack: Level 1
- Flat baked goods or goods in a baking tray: Level 1 or 2

Baking on two or more levels

Use CircoTherm hot air. Items that are placed in the oven on baking trays or in baking tins/dishes at the same time will not necessarily be ready at the same time.













- Universal pan: Position 3
- Baking tray: Position 1

Baking tins

For optimal cooking results, we recommend using dark-coloured metal baking tins.









Tinplate baking tins, ceramic dishes and glass dishes extend baking time and mean that the baked item will not brown evenly.

If you are using silicone moulds, follow the manufacturer's instructions and recipes. Silicone moulds are often smaller than normal baking tins. Quantity and recipe specifications may vary.

Food	Dish	Shelf position	Type of heating	Temperature in °C	Time in minutes
(White) Bread	loaf tin (1x900g or 2x 450g)	1		180 - 200*	20 - 30
Scones	baking sheet	1		190 - 200*	10 - 15
Biscuits	baking sheet	1		150 - 160*	15 - 20
Small Cakes	12-cup-tin	1		150 - 160*	20 - 30
Puff pastry slices	baking tray	1		180 - 200*	15 - 30
Jam tarts	12-cup-tin	1		180 - 190*	15 - 20
Meringue	baking sheet	1		90 - 100	100 - 130
Pavlova	baking sheet	1		90 - 100	150 - 180
Choux pastry	baking tray	1		200 - 220	30 - 45
Meat Pie	rectangular pie tin	1		200 - 210	50 - 60
Yorkshire pudding	12-cup-tin	1		190 - 200**	15 - 25
Pizza, homemade	baking tray	1		200 - 220	20 - 30
Pizza, homemade, thin base	pizza tray	1		250 - 260*	12 - 17

* preheat; do not use rapid heat-up function
** preheat for 20 mins







Baking on two or more levels

Food	Dish	Shelf position	Type of heating	Temperature in °C	Time in minutes
Victoria Sponge Cake, 2 levels	4x Ø20cm tins	3+1		150 - 160*	25 - 35
Scones, 2 levels	2 baking sheets	3+1		170 - 190*	12 - 18
Biscuits, 2 levels	2 baking sheets	3+1		150 - 160*	17 - 25
Small cakes, 2 levels	2x 12-cup-tins	3+1		150 - 160*	22 - 30
Puff pastry slices, 2 levels	2 baking trays	3+1		180 - 200*	20 - 35
Jam tarts, 2 levels	2x 12-cup-tins	3+1		160 - 180*	15 - 25
Meringues, 2 levels	2 baking sheets	3+1		90 - 100	120 - 150
Jacket potatoes, 2 levels	universal pan + baking tray	3+1		150 - 160	75 - 90
Pizza, homemade, 2 levels	universal pan + baking tray	3+1		170 - 190	35 - 50

*preheat

Baking in the top oven

Baking on one level

Food	Dish	Shelf position	Type of heating	Temperature in °C	Time in minutes
Victoria sponge cake	2x Ø20cm tins	1		160-170*	25-30
Swiss roll	Swiss roll tin	1		180-190*	10-15
Scones	Baking sheet	1		200-210*	10-12
Biscuits	Baking sheet	1		170-180*	10-15
Small cakes	12-cup-tin	1		150-160*	25-35
Jam tarts	12-cup-tin	1		190-210*	15-25
Meringue	Baking tray	2		80*	110-140

* Preheat

Baking tips

You want to find out whether the baked item is completely cooked in the middle.	Push a cocktail stick into the highest point on the baked item. If the cocktail stick comes out clean with no dough residue, the baked item is ready.
The baked item collapses.	Next time, use less liquid. Alternatively, set the temperature 10 °C lower and extend the baking time. Adhere to the specified ingredients and preparation instructions in the recipe.

The baked item has risen in the middle but is lower around the edge.	Only grease the base of the springform cake tin. After baking, loosen the baked item carefully with a knife.
The fruit juice overflows.	Next time, use the universal pan.
Small baked items stick to one another during baking.	There should be a gap of approx. 2 cm around each item. This gives enough space for the baked items to expand well and brown on all sides.
The baked item is too dry.	Set the temperature 10 °C higher and shorten the baking time.
The baked item is too light in colour overall.	If the shelf position and the accessories are correct, then you should increase the temperature if necessary or extend the baking time.
The baked item is too light on top, and too dark underneath.	Bake the cake one level higher in the oven the next time.
The baked item is too dark on top, and too light underneath.	Bake the cake one level lower in the oven the next time. Select a lower temperature and extend the baking time.
The baked item is too dark in a tin or loaf tin.	Place the baking tray in the middle of the accessory, not directly against the back wall.
The baked item is too dark in colour overall.	Select a lower temperature next time and extend the baking time if necessary.
The baked item is unevenly browned.	Select a slightly lower temperature. Protruding greaseproof paper can affect the air circulation. Always cut greaseproof paper to size. Ensure that the baking tin does not stand directly in front of the openings in the cooking compartment back wall. When baking small items, you should use similar sizes and thicknesses wherever possible.
You were baking on several levels. The items on the top baking tray are darker than those on the lower baking tray.	Always select hot air when baking on several levels. Baked items that are placed into the oven on trays or in baking tins at the same time will not necessarily be ready at the same time.
The baked item looks good, but is not cooked properly in the middle.	Use a lower temperature and bake slightly longer; if necessary, add slightly less liquid. For baked items with a moist topping, bake the base first. Sprinkle it with almonds or breadcrumbs and then place the topping on top.
The baked item cannot be turned out of the dish when it is turned upside down.	Allow the baked item to cool down for 5 to 10 minutes after baking. If it still sticks, carefully loosen it around the edges again using a knife. Turn the baked item upside down again and cover it several times with a cold, wet cloth. Next time, grease the baking tin and sprinkle with breadcrumbs.

Roasting, braising and grilling

Here, you will find information on roasting, braising and grilling poultry, meat and fish. The settings tables list the optimal settings for a wide range of dishes.

Poultry

When cooking duck or goose, pierce the skin on the underside of the wings. This allows the fat to drain out.

If using duck breast, score the skin. Do not turn duck breasts.

Add a little liquid to the poultry in the cookware. Cover the bottom of the cookware with approx. 0,5-1 cm of liquid.

When you turn poultry, ensure that the breast side or skin side is underneath to begin with.

Poultry will turn out particularly crispy and brown if you baste it towards the end of the roasting time with butter, salted water or orange juice.

Meat

Baste lean meat with fat as required or cover it with strips of bacon. Score the rind crosswise. If you turn the joint when cooking it, ensure that the rind is underneath to begin with.

When the joint is ready, turn off the oven and allow it to rest for a further 10 minutes in the cooking

compartment, keeping the door closed. This helps distribute the meat juices more evenly. Wrap the joint in aluminium foil if necessary. The recommended resting time is not included in the indicated cooking time.

Fish

Whole fish does not need to be turned. Place the whole fish into the cooking compartment in its swimming position, with the dorsal fin at the top. Placing half a potato or a small oven-proof container in the stomach cavity of the fish will keep it upright.

You can tell when the fish is cooked because the dorsal fin can be removed easily.

Roasting and braising on the wire rack

On the wire rack, poultry and meat will become very crispy on all sides. Roasting on the wire rack works particularly well for large poultry or for multiple pieces at the same time.

Add up to 1/2 litre of water to the universal pan, depending on the size and type of meat. Any dripping fat and meat juices will be caught. You can make a sauce from these juices. This will also result in less smoke being produced and keep the cooking compartment cleaner.

Slide the universal pan into the oven at the indicated shelf position with the wire rack on top. Ensure that the wire rack is correctly positioned on the universal pan.

Roasting and braising in cookware

⚠ Warning – Risk of injury from shattering glass!

Place hot glass cookware on a dry mat after cooking. The glass may crack if placed on a cold or wet surface.

⚠ Warning – Risk of scalding!

Very hot steam may escape when opening the lid after cooking. Lift the lid at the rear, so that the hot steam can escape away from you.

It is more convenient to roast and braise meat in cookware. You can take the joint out of the cooking compartment more easily in the cookware, and prepare the sauce in the cookware itself.

Only use cookware that is suitable for use in an oven. Check whether the cookware fits in the cooking compartment.

It is best to use glass cookware. Place hot glass cookware onto a dry mat after cooking. The glass may crack if placed on a cold or wet surface.

When roasting poultry and other meat, add a little liquid.

The liquid in the cookware evaporates as the meat roasts. Carefully pour in more liquid if required.

Shiny roasting dishes made from stainless steel or aluminium reflect heat like a mirror and are therefore not particularly suitable. The meat cooks more slowly and does not brown so well. Use a higher temperature and/or a longer cooking time.

Follow the manufacturer's instructions for your roasting dishes.

Roasting in uncovered cookware

It is best to use a deep roasting dish for roasting poultry and meat. Place the dish onto the wire rack. If you do not have any suitable cookware, use the universal pan.

Braising in covered cookware

Cooking with covered cookware keeps the cooking compartment considerably cleaner. Ensure that the lid fits well and closes properly. Place the cookware onto the wire rack.

The distance between the meat and the lid should be at least 3 cm, as the meat may expand.

Very hot steam may escape when the lid is opened after cooking. Lift the lid at the rear, so that the hot steam can escape away from you.

To braise the meat, sear it first as required. Add water, wine, vinegar or a similar liquid to the braising liquid. Cover the bottom of the cookware with at least 2 cm of liquid.

The liquid in the cookware evaporates as the meat roasts. Carefully pour in more liquid if required.

Grilling flat items

Flat pieces of poultry, meat and fish, such as steaks, drumsticks and burgers, can be cooked effectively

using the "Grill" heating function. It is also excellent for toasting bread.

Grilling

Keep the appliance door closed when using the grill. Never grill with the appliance door open.

Place the food to be grilled on the wire rack. In addition, slide the universal pan in at least one shelf position lower, with the slanted edge facing the appliance door. Any dripping fat will be caught.

When grilling, try wherever possible to use pieces of food which are of a similar thickness and weight. This will allow them to brown evenly and remain succulent and juicy. Place the food to be grilled directly onto the wire rack.

Use tongs to turn the pieces of food you are grilling. If you pierce the meat with a fork, the juices will run out and it will become dry.

Do not add salt to the meat until it has been grilled. Salt draws water from the meat.

Notes

- The grill element switches itself continuously on and off; this is normal. The set temperature determines how frequently this occurs.
- Smoke may be produced when grilling.

Recommended setting values

The table lists values for poultry, meat and fish, with default values for the weight.

The setting values are based on the assumption that unstuffed, chilled, ready-to-roast poultry, meat or fish is placed into a cold cooking compartment.

If you wish to cook heavier poultry, meat or fish, always use the lower temperature. If cooking more than one item, use the weight of the heaviest item as a basis for determining the cooking time. The individual pieces should be approximately the same size.

As a general rule: The larger the poultry, meat or fish, the lower the cooking temperature and the longer the cooking time.

Turn the poultry, meat or fish after approx. ½ to ⅔ of the time listed.

Cover the bottom of the glass cookware with approx. 1/2 cm of liquid.

The quantity of liquid depends on the type of meat, the material the cookware is made from and on whether or not a lid is used. If you are cooking meat in an enamelled or dark-coloured metal roasting dish, it will need a little more liquid than if cooked in glass cookware.

Calculating the cooking time (e.g. 20+35):























To calculate the cooking time, assume 20 minutes per 500 g of meat plus an extra 35 minutes. For 1.5 kg, the cooking time would therefore be 95 minutes.

Cooking time range (e.g. 10-15):

Your food will be ready within the specified range of time (in minutes).















Roasting, braising and grilling in the bottom oven

Roasting and Braising

Food	Dish	Shelf position	Type of heating	Temperature in °C	Time in minutes
Beef, slow roast joint	cookware, uncovered	1		140 - 150	45 + 40
Beef, top side / top rump	cookware, uncovered	1		170 - 180	30 + 25
Lamb, leg (bone-in)	cookware, uncovered	1		160 - 170	25 + 25**
Lamb, shoulder (bone-in)	cookware, uncovered	1		160 - 170	25 + 20
Lamb, shoulder (boned and rolled)	cookware, uncovered	1		170 - 180	25 + 25
Rack of lamb	cookware, uncovered	1		170 - 190*	15 + 25**
Pork, roast joint	cookware, uncovered	1		180 - 190	30 + 35
Pork, loin joint	cookware, uncovered	1		170 - 180	30 + 30
Pork, belly	cookware, uncovered	1		170 - 180	30 + 25***
Pork, gammon joint	cookware, uncovered	1		160 - 170	30 + 30
Chicken, whole	wire rack	1		190 - 200	25 + 15
Chicken, portion (each 200-250g)	cookware, uncovered	1		190 - 210	35 - 45
Duck	cookware, uncovered	1		180 - 190	25 + 20****
Turkey, crown	wire rack	1		150 - 160	20 + 15*****
Turkey, thighs	cookware, uncovered	1		170 - 180	35 + 25
Fish, braised, whole 300g, e.g. trout	cookware, covered	1		170 - 180	40 - 45
Fish, braised, whole 1,5kg, e.g. salmon	cookware, covered	1		190 - 210	50 - 60
Fish fillet, plain, braised	cookware, covered	1		170 - 180	30 - 40
Meat loaf	cookware, uncovered	1		180 - 190	25 + 35
Diced meat (beef, pork, lamb), 500g meat	cookware, covered	1		150*	110 - 130
Diced chicken (boned), 500g meat	cookware, covered	1		140*	90 - 120
Braising steak	cookware, covered	1		140	100 - 120

* preheat
 ** without fat layer (best end neck), do not turn
 *** if you want a crispy crust, change to fan + grill 190 for the last 15 min of cooking time
 **** turn after app. 1 hour
 ***** bone side down, do not turn

Grilling

Food	Dish	Shelf position	Type of heating	Temperature in °C / Grill setting	Time in minutes
Beef, steaks, height 2-3 cm, medium	wire rack	2			1. side 10 - 12 2. side 8 - 10
Beef, burger, height 1-2 cm	wire rack	3		 *	1. side 7-9 2. side 5-6
Lamb, chops, height 1-2 cm	wire rack	2			1. side 6-9 2. side 5-7
Bacon rashers	wire rack	2		 **	1. side 5-6 2. side 4-5
Sausages, thickness 2-4 cm	wire rack	3			10 - 18
Chicken drumstick, 150 g each	wire rack	1		210 - 220	20 - 30
Fish fillets/chops	wire rack	2			15 - 20
Grilling white bread	wire rack	3		 **	0.5 - 1

* preheat for 3 min
 ** preheat for 5 min

Food	Dish	Shelf position	Type of heating	Temperature in °C	Time in minutes
Beef, top side / top rump	cookware uncovered	1		150 - 160	30 + 30
Lamb, leg (bone-in)	cookware uncovered	1		160 - 170	25 + 25
Lamb, shoulder (bone-in)	cookware uncovered	1		170 - 180	25 + 15
Lamb, shoulder (boned and rolled)	cookware uncovered	1		170 - 180	20 + 15
Rack of lamb	cookware uncovered	1		170 - 190	15 + 25
Pork, roast joint	cookware uncovered	1		170 - 180	30 + 40
Pork, gammon joint	cookware uncovered	1		160 - 180	30 + 25**
Chicken portion, bone-in, 200-250 g each	wire rack	1		210 - 220	35 - 40
Chicken, whole	cookware uncovered	1		200 - 220	20 + 15
Duck, 2-3 kg	cookware uncovered	1		180 - 200	20 + 20
Turkey, thighs	cookware uncovered	1		160 - 170	30 + 30
Trout, whole, 300 g each	wire rack	2		170 - 180	20 - 25***
* preheat					
** do not turn					
*** slide in the universal pan underneath the wire rack					

Grilling in the top oven

Food	Dish	Shelf position	Type of heating	Grill setting	Time in minutes
Beef, steaks, height 2-3cm	Wire rack	3		*	1. side 10-13 2. side 6-8
Beef, burger, height 1-2cm	Wire rack	3			1. side 10-12 2. side 6-8
Lamb, steaks, height 2-3cm	Wire rack	3		*	1. side 6-8 2. side 4-6
Lamb, chops, height 2-3cm	Wire rack	3		*	1. side 7-9 2. side 5-8
Pork, steaks, height 1-2cm	Wire rack	3		*	1. side 9-12 2. side 6-8
Pork, chops, height 2-3cm	Wire rack	3		*	1. side 10-13 2. side 8-12
Pork, burger, height 1-2cm	Wire rack	3			1. side 10-12 2. side 6-8
Pork, sausages, thickness 2-4cm	Wire rack	3		**	14-18
Chicken drumstick, 150g each	Wire rack	2		250	1. side 16-20 2. side 12-15
Chicken breast, boneless, 150g each	Wire rack	3		250*	1. side 13-15 2. side 8-10
Fish fillets/chops, each 150g	Wire rack	3		220	15-20
Grilling white bread	Wire rack	3			3-5
* Preheat					
** Turn frequently					

Ready meals

Here, you will find the ideal settings for preparing chilled and frozen meals.















Notes

- The cooking result greatly depends on the quality of the food. Pre-browning and irregularities are sometimes already present on the raw product.
- Do not use frozen products that are covered with a thick layer of ice. Remove any ice on the food.
- Distribute foods that are in the form of separate pieces, such as bread rolls and potato products, so that they are spread out flat and evenly on the accessory. Leave a little space between the individual pieces.
- Follow the manufacturer's instructions on the packaging.

Shelf positions





Use the shelf positions indicated.

Baking in the main oven

Food	Dish	Shelf position	Type of heating	Temperature in °C	Time in minutes
Pizza, chilled	wire rack	1		200 - 210*	10 - 15
Pizza, thin base	wire rack	1		190 - 200	15 - 20
Pizza, thin base, 2 levels	universal pan + wire rack	3+1		190 - 200	20 - 25
Pizza, thick base	wire rack	1		190 - 200	20 - 25
Pizza, thick base, 2 levels	universal pan + wire rack	3+1		190 - 210	20 - 30
Oven chips, Croquettes	universal pan	1		190 - 200	25 - 30
Oven chips, 2 levels	universal pan + baking tray	3+1		200 - 220	30 - 40
Hash browns	universal pan	1		200 - 210	25 - 35
Fish fingers	universal pan	1		200 - 220*	15 - 20
Chicken nuggets	universal pan	1		190 - 210	20 - 25
Lasagna, 500g	ovenproof dish on wire rack	1		180 - 200	30 - 40
Lasagna, 1,5kg	ovenproof dish on wire rack	1		180 - 200	35 - 45
Lasagna, 500g	ovenproof dish on wire rack	1		190 - 210	30 - 40
Lasagna, 1,5kg	ovenproof dish on wire rack	1		170 - 190	60 - 75

*preheat

Baking in the top oven

Food	Dish	Shelf position	Type of heating	Temperature in °C	Time in minutes
Pizza, frozen, thin base	Wire rack	1		180-200	10-20
Oven chips, Croquettes, frozen	Universal pan	1		200-220	25-35
Fish fingers, frozen	Universal pan	1		190-200	10-15
Chicken nuggets, frozen	Universal pan	1		190-210*	20-25

* Preheat

Baking on one level

When baking on one level, use the following shelf positions:

- Tall baked items: Level 1
- Flat baked items: Level 1

Baking on two levels

Use CircoTherm hot air. Items that are placed in the oven on baking trays or in baking tins/dishes at the same time will not necessarily be ready at the same time.

- Universal pan: Position 3
Baking tray: Position 1

Recommended setting values

The table lists the optimal heating function for various types of food. The temperature and cooking time depend on the amount and consistency of the dough/mixture. Settings ranges are specified for this reason. Try using the lower values to start with. A lower temperature will result in more even browning. You can use a higher setting next time if necessary.

Desserts

You can make your own soufflés and yogurt using your appliance.

Soufflés

You can also prepare soufflés in a water bath in the universal pan. To do so, slide the universal pan in at level 2.

Yogurt

Remove accessories and shelves from the cooking

compartment. The cooking compartment must be empty.

1. Heat 1 litre of milk (3.5 % fat) to 90 °C on the hob and then cool down to 40 °C.
It is sufficient to heat UHT milk to 40 °C.
2. Stir in 150 g (chilled) yogurt.
3. Pour into cups or small jars and cover with cling film.
4. Place the cups or jars onto the cooking compartment floor and set as indicated in the table.
5. After preparation, leave the yogurt to cool in the refrigerator.

Food	Dish	Shelf position	Type of heating	Temperature in °C	Time in minutes
Yoghurt	Individual moulds	Cooking compartment floor		50	6 - 7h

Acrylamide in foodstuffs

Acrylamide is mainly produced in grain and potato products prepared at high temperatures, such as potato

crisps, chips, sliced bread, bread rolls, bread or fine baked goods (biscuits, gingerbread, spiced biscuit).

Tips for keeping acrylamide to a minimum	
General	<ul style="list-style-type: none"> ■ Keep cooking times as short as possible. ■ Cook food until it is golden brown, but not too dark. ■ Large, thick pieces of food contain less acrylamide.
Baking	With top/bottom heating at max. 200 °C. With hot air at max. 180 °C.
Biscuits	With top/bottom heating at max. 190 °C. With hot air at max. 170 °C. Egg or egg yolk reduces the production of acrylamide.
Oven chips	Spread out a single layer evenly on the baking tray. Cook approx. 400-600 g at once on a baking tray so that the chips do not dry out and become crunchy.

Drying

You can achieve outstanding drying results with CircoTherm. With this type of preserving, flavours are concentrated as a result of the dehydration.

Only use unblemished fruit, vegetables and herbs and wash them thoroughly. Line the wire rack with greaseproof paper or parchment paper. Drain the excess water from the fruit and dry it.

If necessary, cut it into equal chunks or thin slices. Place unpeeled fruit onto the dish with the sliced surfaces facing upwards. Ensure that neither fruit nor mushrooms overlap on the wire rack.

Grate vegetables and then blanch them. Drain the blanched vegetables thoroughly and spread them evenly on the wire rack.

Dry herbs on the stem. Position the herbs evenly and slightly heaped on the wire rack.



Use the following shelf positions for drying:



- 1 wire rack: Level 2
- 2 wire racks: Level 3+1

Turn very juicy fruit and vegetables several times. After drying, remove the dried fruit and vegetables from the paper immediately.

The table contains settings for drying various foodstuffs. The temperature and drying time are dependent on the type, moisture, ripeness and thickness of the food to be dried. The longer you leave the food to be dried, the better it will be preserved. The thinner the slices are, the quicker the drying process will be and the more flavour the dried food will retain. Settings ranges are specified for this reason.

If you want to dry food that is not listed in the table, you should use similar foodstuffs in the table as a reference.

Fruit, vegetables and herbs	Accessories	Insertion level	Type of heating	Temperature in °C	Time
Pomes (apple rings, 3 mm thick, 200 g per wire rack))	1-2 wire racks	steht im Text		80	4 - 8 h
Root vegetables (carrots), grated, blanched	1-2 wire racks	steht im Text		80	4 - 7 h

Fruit, vegetables and herbs	Accessories	Insertion level	Type of heating	Temperature in °C	Time
Sliced mushrooms	1-2 wire racks	steht im Text		80	5 - 8 h
Herbs, prepared	1-2 wire racks	steht im Text		60	2 - 5 h

Preserving

You can preserve fruit and vegetables using your appliance.

Warning – Risk of injury!

If the food is preserved incorrectly, the preserving jars may burst. Follow the instructions for preserving.

Jars

Only use clean and undamaged preserving jars. Only use heat-resistant, clean and undamaged rubber rings. Check clips and clamps in advance.

For each preserving process, only use preserving jars that are the same size and contain the same food. In the cooking compartment, you can preserve the contents of a maximum of six ½, 1 or 1½-litre preserving jars at the same time. Do not use jars that are larger or taller than this. The lids could rupture.

Preserving jars must not touch one another in the cooking compartment during the preserving process.

Preparing fruit and vegetables

Only use fruit and vegetables that are in good condition. Wash them thoroughly.

Peel, core and chop fruit and vegetables appropriate to their type and fill the preserving jars with them up to approx. 2 cm below the rim.

Fruit: Fill the preserving jars with the fruit along with a hot, skimmed sugar solution (approx. 400 ml for a 1-litre jar). For one litre of water:

- Approx. 250 g sugar for sweet fruit
- Approx. 500 g sugar for sour fruit

Vegetables: Fill the jars with the vegetables along with hot, boiled water.

Wipe the rims of the jars, as they must be clean. Place a damp rubber ring and a lid on each jar. Seal the jars with the clips. Place the jars into the universal pan so that they do not touch each other. Pour 500 ml hot water (approx. 80 °C) into the universal pan. Use the settings indicated in the table.





Ending the preserving process

Fruit: After a short while, small bubbles will form at short intervals. Switch off the appliance once all preserving jars are bubbling. Remove the jars from the cooking compartment after the indicated residual heating time.

Vegetables: After a short while, small bubbles will form at short intervals. As soon as all preserving jars are bubbling, reduce the temperature to 120 °C and allow the jars to continue to bubble in the closed cooking compartment as indicated in the table. After this time has elapsed, switch off the appliance and make use of the residual heat for several minutes as indicated in the table.

After preserving, remove the jars from the cooking compartment and place them onto a clean cloth. Do not place these hot jars onto a cold or damp surface, as they may crack. Cover the preserving jars to protect them from draughts. Only remove the clamps once the jars are cold.

The indicated times in the settings table are average values for preserving fruit and vegetables. They may be influenced by room temperature, the number of jars, quantity, heat and quality of the jar contents. The specifications are based on 1-litre round jars. Before you switch off the appliance or change the cooking mode, check whether the contents of the jars are bubbling as they should. The bubbling process starts after approx. 30-60 minutes.

Food	Dish	Insertion level	Type of heating	Step	Temperature in °C	Time in minutes
Vegetables, e.g. carrots	1-litre preserving jars	1		1.	160-170	Before it starts bubbling: 30-40
				2.	120	Once it starts bubbling: 30-40
				3.	-	Residual heat: 30
Vegetables, e.g. cucumbers	1-litre preserving jars	1		1.	160-170	Before it starts bubbling: 30-40
				2.	-	Residual heat: 30
Stone fruit, e.g. cherries, damsons	1-litre preserving jars	1		1.	160-170	Before it starts bubbling: 30-40
				2.	-	Residual heat: 35
Pomes, e.g. apples, strawberries	1-litre preserving jars	1		1.	160-170	Before it starts bubbling: 30-40
				2.	-	Residual heat: 25

Prove dough



Your yeast dough will prove considerably more quickly using this heating function than at room temperature and will not dry out. Do not start the appliance if the cooking compartment is not completely cool.

Always allow yeast dough to prove twice. Use the settings indicated in the settings tables for the first and second proving stages (dough fermentation stage and final fermentation stage).

Dough fermentation

Place the dough into a heat-resistant bowl and place this onto the wire rack. Use the settings indicated in the table.

Do not open the appliance door while the dough is proving, otherwise moisture will escape. Do not cover the dough.

Food	Dish	Shelf position	Type of heating	Step	Temperature in °C	Time in mins
Yeast dough, light	Bowl, baking sheet	1		1.	50	25-30
				2.	50	10-20
Yeast dough, heavy and rich	Bowl, baking sheet	1		1.	50	20-40
				2.	50	15-25



Defrosting

For defrosting frozen fruit, vegetables and baked items. Poultry, meat and fish should ideally be defrosted in the refrigerator. Not suitable for cream cakes or cream gateaux.

Use the following shelf positions when defrosting:

- 1 wire rack: Position 1

The times indicated in the table are intended as a guide only. They are dependent on the quality, freezing temperature (-18 °C) and composition of the food. Time ranges are indicated. Set the shortest time first and then extend the time if necessary.

Food	Dish	Shelf position	Type of heating	Temperature in °C	Time in mins
Bread, general	Baking tray	1		50	40-70
Cake, moist	Baking tray	1		50	70-90
Cake, dry	Baking tray	1		60	60-75

Keeping warm

You can keep cooked dishes warm using the top/bottom heating type at 70 °C. This will avoid condensation developing, and means you will not have to wipe out the cooking compartment.

Do not keep cooked dishes warm for longer than two hours. Be aware that some dishes may continue cooking whilst being kept warm. Cover the dishes if necessary.

Condensation builds up during the proving process, which steams up the door panel. Wipe out the cooking compartment after dough proving. Remove any limescale with a little vinegar and wipe with clean water.

Final fermentation

Place your dough into the oven at the shelf position indicated in the table.

If you want to preheat the oven, the final fermentation stage takes place outside the appliance in a warm place.

The temperature and proving time are dependent on the type and quantity of the ingredients. For this reason, the values indicated in the settings table are intended as a guide only.

Tip: Food that has been frozen flat or in portions defrosts more quickly than food items frozen in a block.

Remove frozen food from its packaging and place it onto the wire rack in suitable cookware.

Redistribute the food or turn it once or twice as it defrosts. Large pieces of food should be turned frequently. As the food defrosts, break up any clumps and remove items which have already defrosted from the cooking compartment.

To allow the temperature to equalise, leave the defrosted food to rest for another 10 to 30 minutes in the appliance after switching it off.

Test dishes

These tables have been produced for test institutes to facilitate appliance testing.

As per EN 60350-1.

Baking

Items that are placed in the oven on baking trays or in baking tins/dishes at the same time will not necessarily be ready at the same time.

Shelf positions for baking on two levels:

- Universal pan: Position 3
Baking tray: Position 1

Baking with two springform cake tins:

- On a single level:

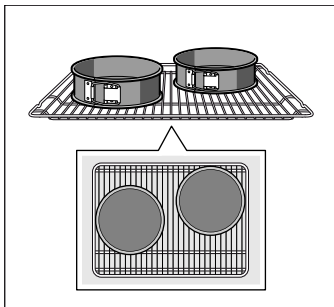

Baking in the main oven

Food	Dish	Shelf position	Type of heating	Temperature in °C / Grill setting	Time in minutes
Shortbread	Baking tray	1	≡	140 - 150**	20 - 25
Shortbread	Baking tray	1	⌘	140 - 150**	20 - 35
Shortbread, 2 levels	Universal pan + Baking tray	3+1	⌘	140 - 150**	25 - 40
Small Cakes	Baking tray	1	⌘	150 - 160	30 - 35
Small Cakes	Baking tray	2	≡	150 - 160**	20 - 30
Small Cakes, 2 levels	Universal pan + Baking tray	3+1	⌘	150 - 160**	25 - 35
Fatless sponge cake	26 cm springform cake tin	1	≡	160 - 170*	25 - 35
Fatless sponge cake	26 cm springform cake tin	1	⌘	160 - 170*	25 - 35
Double-crust apple pie	2 x 20 cm black cake tins	1	⌘	160 - 170	70 - 80
Double-crust apple pie	2 x 20 cm black cake tins	1	≡	180 - 190	60 - 80
Grilling white bread	Wire rack	3	⌘	⌘**	0,5 - 1,0
Beef burger, 12 pieces	Wire rack	2	⌘	⌘	25 - 30

* Preheat; do not use rapid heat-up function.

** Preheat 5 mins; do not use rapid heat-up function.

Grilling in the top oven

Food	Dish	Shelf position	Type of heating	Grill setting	Time in minutes
Grilling white bread	Wire rack	3	⌘	⌘	4-6
Beef burger, 12 pieces	Wire rack	3	⌘	⌘	25-30

Notes

- The setting values apply to dishes placed into a cold cooking compartment.
- Please note the information in the tables about preheating. The setting values are valid without rapid heating-up.
- For baking, use the lower of the indicated temperatures first.

Grilling

Also slide in the universal pan. The liquid will be caught and the cooking compartment stays cleaner.



REGISTER YOUR PRODUCT
ONLINE NEFF-HOME.COM



Constructa NEFF Vertriebs-GmbH |
Carl-Wery-Straße 34 | 81739 Munich | Germany

9001413549
990215
en