







BUILT-IN OVEN

[en] INSTRUCTION MANUAL

C17FS32H0B

Table of contents

 Intended use	4	 Time-setting options	21
 Important safety information	5	Showing and hiding the time-setting options	21
General information	5	Setting the timer	21
Steam	6	Setting the cooking time	21
Cleaning function	6	Start delay – "Ready at"	21
 Causes of damage	6	Checking, changing or deleting settings	21
General information	6	 Childproof lock	22
Steam	7	Automatic childproof lock	22
 Environmental protection	7	One-time childproof lock	22
Saving energy	7	 Basic settings	23
Environmentally-friendly disposal	8	Changing MyProfile	23
 Getting to know your appliance	9	List of basic settings	23
Control panel	9	Setting favourites	23
Controls	9	 Baking and roasting assistant	24
Main menu	10	Information on the settings	24
Types of heating menu	10	Selecting a meal	24
Cooking compartment functions	11	Setting the food	24
Water tank	11	 Programmes	25
 Accessories	12	Information on the settings	25
Accessories included	12	Selecting a dish	26
Inserting accessories	12	Setting a programme	26
Combining accessories	12	 Sabbath mode	27
Optional accessories	13	Starting Sabbath mode	27
 Before using for the first time	13	Cancelling Sabbath mode	27
Initial use	13	 Home Connect	27
Calibrating the appliance and cleaning the cooking compartment	14	Setting up	27
Cleaning the accessories	14	Remote Start	27
 Operating the appliance	15	Home Connect settings	28
Switching the appliance on and off	15	Remote diagnostics	28
Setting and starting the appliance operation	15	About data protection	28
Changing or cancelling the appliance operation	16	Declaration of Conformity	28
Heating up the appliance quickly	16	 Cleaning agent	29
 Steam	17	Suitable cleaning agents	29
Noise	17	Surfaces in the cooking compartment	30
FullSteam – Steam cooking	17	Keeping the appliance clean	30
VarioSteam – Steam-assisted cooking	17	 Cleaning function	31
Dough proving setting	18	EcoClean	31
Defrost setting	18	Floor cleaning aid	31
Reheating	18	Descaling	32
Filling the water tank	18	 Rails	33
After every steam operation	20	Detaching and refitting the rails	33

	Appliance door	34
	Detaching and refitting the appliance door	34
	Removing and installing the door panels.....	34
	Trouble shooting	37
	Fault table	37
	Maximum operating time exceeded.....	38
	Cooking compartment bulbs	38
	Customer service	39
	E number and FD number	39
	Tested for you in our cooking studio	39
	Silicone moulds	39
	Baking	39
	Roasting and braising	42
	Grilling	46
	Convenience products	49
	Steaming	50
	Yogurt	53
	Eco heating functions.....	53
	Acrylamide in foodstuffs.....	54
	Slow cook	55
	Drying.....	56
	Preserving and juicing	57
	Sterilising bottles and hygiene	57
	Allowing the dough to prove at dough proving setting	58
	Defrosting.....	59
	Reheating.....	59
	Keeping warm	60
	Test dishes.....	61

Additional information on products, accessories, replacement parts and services can be found at www.neff-international.com and in the online shop www.neff-eshop.com

Intended use

Read these instructions carefully. Only then will you be able to operate your appliance safely and correctly. Retain the instruction manual and installation instructions for future use or for subsequent owners.

This appliance is only intended to be fully fitted in a kitchen. Observe the special installation instructions.

Check the appliance for damage after unpacking it. Do not connect the appliance if it has been damaged in transport.

Only a licensed professional may connect appliances without plugs. Damage caused by incorrect connection is not covered under warranty.

This appliance is intended for domestic use only. The appliance must only be used for the preparation of food and drink. The appliance must be supervised during operation. Only use this appliance indoors.

This appliance is intended for use up to a maximum height of 2000 metres above sea level.

This appliance may be used by children over the age of 8 years old and by persons with reduced physical, sensory or mental capabilities or by persons with a lack of experience or knowledge if they are supervised or are instructed by a person responsible for their safety how to use the appliance safely and have understood the associated hazards.

Children must not play with, on, or around the appliance. Children must not clean the appliance or carry out general maintenance unless they are at least 15 years old and are being supervised.

Keep children below the age of 8 years old at a safe distance from the appliance and power cable.

Always slide accessories into the cooking compartment the right way round.

→ "Accessories" on page 12

Important safety information

General information

Warning – Risk of fire!

- Combustible items stored in the cooking compartment may catch fire. Never store combustible items in the cooking compartment. Never open the appliance door if there is smoke inside. Switch off the appliance and unplug it from the mains or switch off the circuit breaker in the fuse box.
- Loose food remnants, fat and meat juices may catch fire. Before using the appliance, remove the worst of the food remnants from the cooking compartment, heating elements and accessories.
- A draught is created when the appliance door is opened. Greaseproof paper may come into contact with the heating element and catch fire. Do not place greaseproof paper loosely over accessories during preheating. Always weight down the greaseproof paper with a dish or a baking tin. Only cover the surface required with greaseproof paper. Greaseproof paper must not protrude over the accessories.

Warning – Risk of burns!

- The appliance becomes very hot. Never touch the interior surfaces of the cooking compartment or the heating elements. Always allow the appliance to cool down. Keep children at a safe distance.
- Accessories and ovenware become very hot. Always use oven gloves to remove accessories or ovenware from the cooking compartment.
- Alcoholic vapours may catch fire in the hot cooking compartment. Never prepare food containing large quantities of drinks with a high alcohol content. Only use small quantities of drinks with a high alcohol content. Open the appliance door with care.

Warning – Risk of scalding!

- The accessible parts become hot during operation. Never touch the hot parts. Keep children at a safe distance.
- When you open the appliance door, hot steam can escape. Steam may not be visible, depending on its temperature. When opening, do not stand too close to the appliance. Open the appliance door carefully. Keep children away.
- Water in a hot cooking compartment may create hot steam. Never pour water into the cooking compartment when the cooking compartment is hot.

Warning – Risk of injury!

- Scratched glass in the appliance door may develop into a crack. Do not use a glass scraper, sharp or abrasive cleaning aids or detergents.
- The hinges on the appliance door move when opening and closing the door, and you may be trapped. Keep your hands away from the hinges.

Warning – Risk of electric shock!

- Incorrect repairs are dangerous. Repairs may only be carried out and damaged power cables replaced by one of our trained after-sales technicians. If the appliance is defective, unplug the appliance from the mains or switch off the circuit breaker in the fuse box. Contact the after-sales service.
- The cable insulation on electrical appliances may melt when touching hot parts of the appliance. Never bring electrical appliance cables into contact with hot parts of the appliance.
- Do not use any high-pressure cleaners or steam cleaners, which can result in an electric shock.
- A defective appliance may cause electric shock. Never switch on a defective appliance. Unplug the appliance from the mains or switch off the circuit breaker in the fuse box. Contact the after-sales service.

Warning – Hazard due to magnetism!

Permanent magnets are used in the control panel or in the control elements. They may affect electronic implants, e.g. heart pacemakers or insulin pumps. Wearers of electronic implants must stay at least 10 cm away from the control panel.

Steam

Warning – Risk of scalding!

- The water in the water tank may become very hot if you continue to operate the appliance. Empty the water tank after every operation with steam.
- Hot steam is generated in the cooking compartment. Do not reach into the cooking compartment during any operation with steam.
- Hot liquid may spill over the sides of the accessory when it is removed from the cooking compartment. Remove hot accessories with care and always wear oven gloves.

Warning – Risk of injury and risk of fire!

Flammable liquids can catch fire in the cooking compartment when it is hot (explosion). Do not fill the water tank with any flammable fluids (e.g. alcoholic drinks). Only fill the water tank with water or with the descaling solution that is recommended by us.

Cleaning function

Warning – Risk of burns!

 The appliance becomes very hot on the outside during the cleaning function. Never touch the appliance door. Allow the appliance to cool down. Keep children at a safe distance.

Causes of damage

General information

Caution!

- Accessories, foil, greaseproof paper or ovenware on the cooking compartment floor: do not place accessories on the cooking compartment floor. Do not cover the cooking compartment floor with any sort of foil or greaseproof paper. Do not place ovenware on the cooking compartment floor if a temperature of over 50 °C has been set. This will cause heat to accumulate. The baking and roasting times will no longer be correct and the enamel will be damaged.
- Aluminium foil: Aluminium foil in the cooking compartment must not come into contact with the door glass. This could cause permanent discolouration of the door glass.
- Water in a hot cooking compartment: do not pour water into the cooking compartment when it is hot. This will cause steam. The temperature change can cause damage to the enamel.
- Moisture in the cooking compartment: Over an extended period of time, moisture in the cooking compartment may lead to corrosion. Allow the cooking compartment to dry after use. Do not keep moist food in the closed cooking compartment for extended periods of time. Do not store food in the cooking compartment.
- Cooling with the appliance door open: Following operation at high temperatures, only allow the cooking compartment to cool down with the door closed. Do not trap anything in the appliance door. Even if the door is only left open a crack, the front of nearby furniture may become damaged over time. Only leave the cooking compartment to dry with the door open if a lot of moisture was produced whilst the oven was operating.
- Fruit juice: when baking particularly juicy fruit pies, do not pack the baking tray too generously. Fruit juice dripping from the baking tray leaves stains that cannot be removed. If possible, use the deeper universal pan.
- Extremely dirty seal: If the seal is very dirty, the appliance door will no longer close properly during operation. The fronts of adjacent units could be damaged. Always keep the seal clean. Never operate the appliance if the seal is damaged or missing.
- Appliance door as a seat, shelf or worktop: Do not sit on the appliance door, or place or hang anything on it. Do not place any cookware or accessories on the appliance door.
- Inserting accessories: depending on the appliance model, accessories can scratch the door panel when closing the appliance door. Always insert the accessories into the cooking compartment as far as they will go.
- Carrying the appliance: do not carry or hold the appliance by the door handle. The door handle cannot support the weight of the appliance and could break.

Steam

Caution!

- Baking tins: Ovenware must be heat and steam resistant. Silicone baking tins are not suitable for combined operation with steam.
- Ovenware with areas of rust: Do not use any ovenware which displays areas of rust. Even the smallest spots of rust can lead to corrosion in the cooking compartment.
- Dripping liquids: When steaming with a perforated cooking container, always insert the baking tray, the universal pan or the solid cooking container underneath. Dripping liquid is caught.
- Hot water in the water tank: Hot water can damage the pump. Only fill the water tank with cold water.
- Enamel damage: Do not start any operations when there is water on the cooking compartment floor. Before operation, wipe away the water from the cooking compartment floor.
- Descaling solution: Do not allow any descaling solution to come into contact with the control panel or other surfaces on the appliance. This damages the surfaces. If this does happen, remove the descaling solution immediately with water.
- Cleaning the water tank: Do not clean the water tank in the dishwasher. Otherwise, the water tank will be damaged. Clean the water tank with a soft cloth and standard washing-up liquid.

Environmental protection

Your new appliance is particularly energy-efficient. Here you can find tips on how to save even more energy when using the appliance, and how to dispose of your appliance properly.

Saving energy

- Only preheat the appliance if this is specified in the recipe or in the tables in the operating instructions.
- Leave frozen food to defrost before placing it in the cooking compartment.

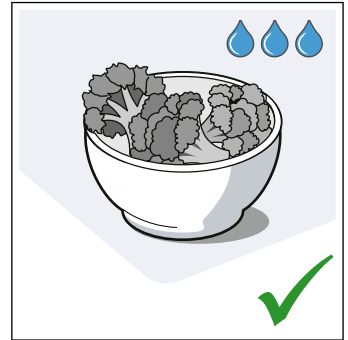
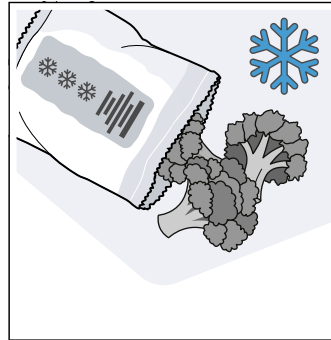

- Use baking tins that are dark-coloured, painted black or have an enamel coating. These absorb the heat particularly well.

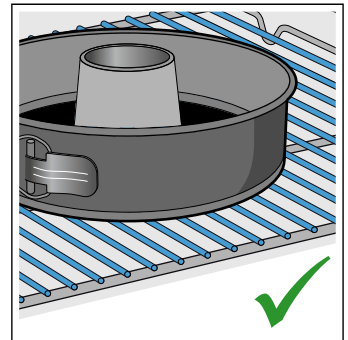
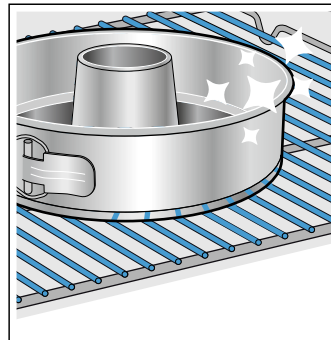

- Remove any unnecessary accessories from the cooking compartment.

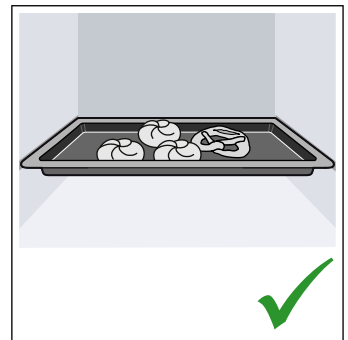
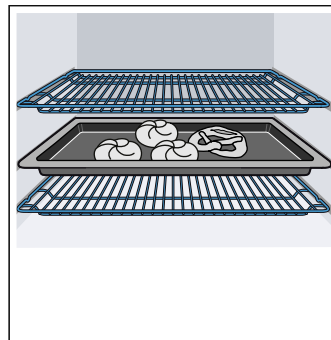

en Environmental protection

- Open the appliance door as infrequently as possible when the appliance is in use.

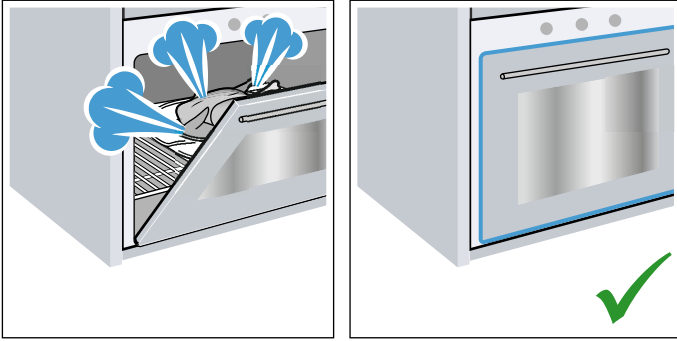

- It is best to bake several cakes one after the other. The cooking compartment stays warm. This reduces the baking time for the second cake. You can place two cake tins next to each other in the cooking compartment.

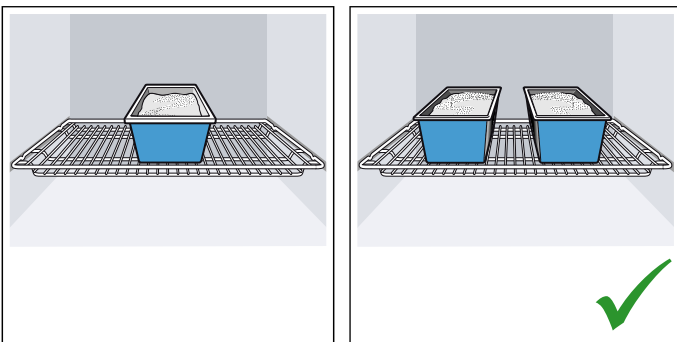

- For longer cooking times, you can switch the appliance off 10 minutes before the end of the cooking time and use the residual heat to finish cooking.

Environmentally-friendly disposal

Dispose of packaging in an environmentally-friendly manner.



This appliance is labelled in accordance with European Directive 2012/19/EU concerning used electrical and electronic appliances (waste electrical and electronic equipment - WEEE). The guideline determines the framework for the return and recycling of used appliances as applicable throughout the EU.

Getting to know your appliance

In this section, we will explain the indicators and controls. You will also find out about the various functions of your appliance.

Note: Depending on the appliance model, individual details and colours may differ.

Control panel

You can set your appliance's various functions on the control panel. The current settings are shown in the display.

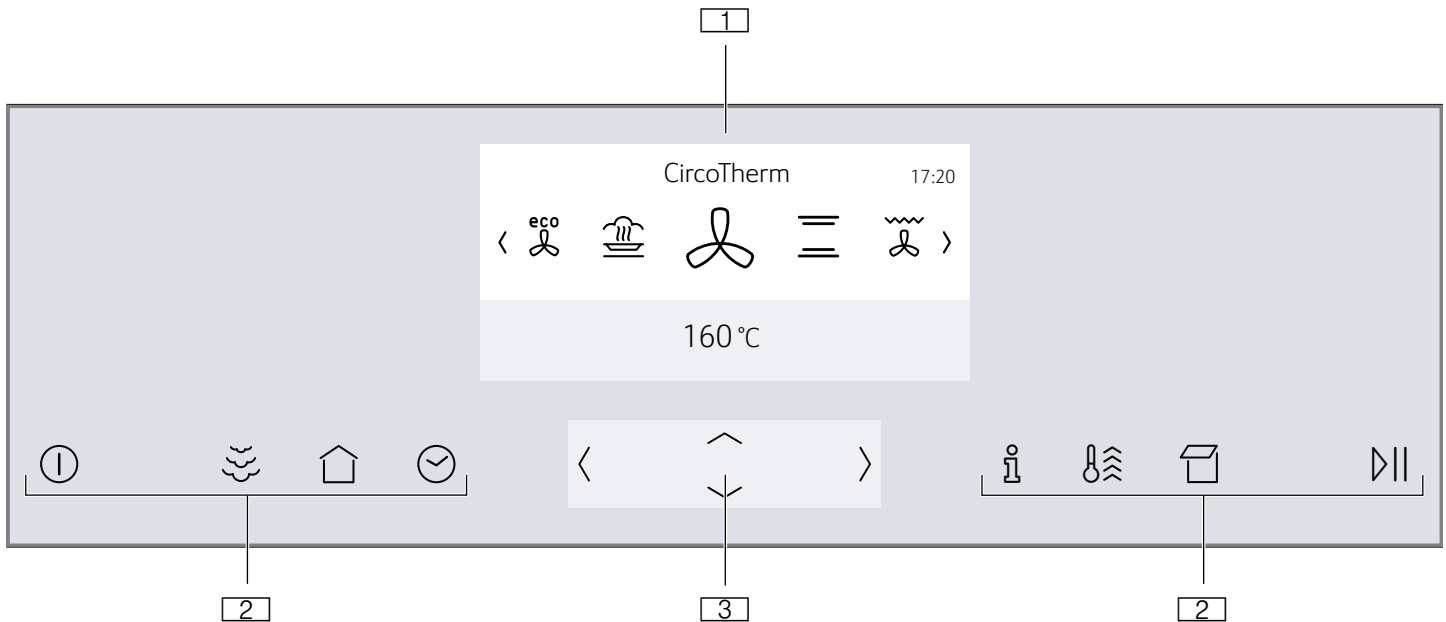





- 1** Display
- 2** Touch buttons
- 3** ShiftControl control element





Controls

Use the controls to set your appliance simply and directly.

Touch buttons

There are sensors under the touch buttons. Touch the corresponding touch button to select a function.

Touch button	Use
 On/off	Switches the appliance on or off → "Switching the appliance on and off" on page 15
 Steam-assisted cooking	Switching on steam-assisted cooking → "VarioSteam - Steam-assisted cooking" on page 17
 Main menu	Selects operating modes and settings → "Setting and starting the appliance operation" on page 15
 Time-setting options	Sets the timer, cooking time or "Finished at" start delay → "Time-setting options" on page 21
Childproof lock	Activating and deactivating the childproof lock → "Childproof lock" on page 22

 Information	Displays additional information Displays the current temperature → "Setting and starting the appliance operation" on page 15
 Rapid heating	Activating or deactivating rapid heating → "Heating up the appliance quickly" on page 16 Activating or deactivating Power-Boost → "Heating up the appliance quickly" on page 16
 Open cover	Filling or emptying the water tank → "Filling the water tank" on page 18
 Start/stop	Start or pause the appliance → "Setting and starting the appliance operation" on page 15

ShiftControl control element



Use the ShiftControl control element to navigate through the lines on the display and select the settings. Settings that you can change are displayed more brightly.







Button	Use
<	Left Navigates to the left in the display
>	Right Navigates to the right in the display
^	Up Navigates upwards in the display
v	Down Navigates downwards in the display

Note: You can also scroll through the settings values quickly by pressing and holding a button. As soon as you release the button, you stop scrolling through the values quickly.

Main menu











Touch the  touch button to access the main menu.





Menu	Use
	Types of heating Select the desired heating type and temperature for your food → "Switching the appliance on and off" on page 15
	Steam cooking Cooking with steam → "FullSteam – Steam cooking" on page 17
	Baking and roasting assistant Recommended settings for baking and roasting → "Baking and roasting assistant" on page 24

	Steam programmes Preparing dishes with steam → "Programmes" on page 25
	MyProfile Individually adjusting the appliance settings → "Basic settings" on page 23
	Home Connect Assistant Connecting your appliance to your mobile device → "Basic settings" on page 23
	Descal
	Drying Drying the cooking compartment after a steam operation → "After every steam operation" on page 20
	Floor cleaning aid Cleaning the cooking compartment floor → "Cleaning function" on page 31
	EcoClean Cleaning the cooking compartment → "Cleaning function" on page 31

Types of heating menu

Your appliance comes with various types of heating. After switching on the appliance, you are taken directly to the menu for the types of heating.

Type of heating	Temperature	Use
 CircoTherm *	40 - 200 °C	For baking and cooking on one or more levels. The fan distributes the heat from the ring heating element in the back panel evenly around the cooking compartment.
 Top/bottom heating *	50 - 250 °C	For traditional baking and roasting on one level. Especially suitable for cakes with moist toppings. Heat is emitted evenly from the top and bottom.
 Circo-roasting *	50 - 250 °C	For roasting poultry, whole fish and larger pieces of meat. The grill element and the fan switch on and off alternately. The fan circulates the hot air around the food.
 Circotherm intensive	50 - 250 °C	For preparing pizza and dishes which require a lot of heat from underneath. The bottom heating element and the ring heating element in the back panel heat up.
 Bread-baking *	180 - 240 °C	For baking bread, bread rolls and baked items that require high temperatures.
 Full-surface grill	50 - 275 °C	For grilling flat items, such as steaks or sausages, for making toast, and for au gratin dishes. The whole area below the grill element becomes hot.
 Centre-area grill	50 - 275 °C	For grilling small amounts of steaks or sausages, for making toast, and for au gratin dishes. The centre area under the grill heating element becomes hot.
 Bottom heat	30 - 250 °C	For cooking in a bain marie and for the final baking stage. The heat is emitted from below.
 Slow cooking	70 - 120 °C	For gentle and slow cooking of seared, tender pieces of meat in ovenware without a lid. Heat is emitted evenly from above and below at low temperatures.
 Dough proving **	2 levels	For leaving yeast dough and sourdough to prove and for culturing yogurt. Dough will prove more quickly than at room temperature. The surface of the dough does not dry out.

	Defrost setting **	30 - 60 °C	For gently defrosting frozen food.
	Keep warm *	60 - 100 °C	For keeping cooked food warm.
	Top/bottom heating eco	50-250 °C	For gently cooking selected types of food. Heat is emitted from above and below. This heating function is most effective between 150 and 250 °C. This heating function is used to measure the energy consumption in the conventional mode.
	CircoTherm eco	40-200 °C	For gently cooking selected types of food on one level without preheating. The fan distributes the heat from the ring-shaped heating element in the back panel around the cooking compartment. This heating function is most effective between 125 and 200 °C. This type of heating is used to measure both the energy consumption in air recirculation mode and the energy-efficiency class.
	Reheat **	80 - 180 °C	For gently reheating food or for crisping up pastries.
* Possible to use steam for this type of heating (operation only possible when the water tank is full)			
** Type of steam heating (operation only possible when the water tank is full)			

Cooking compartment functions

The features of the cooking compartment make your appliance easier to use. This, for example, enables the cooking compartment to be well lit and a cooling fan to prevent the appliance from overheating.

Opening the appliance door

If you open the appliance door while the appliance is in operation, this pauses the programme. The operation continues to run when you close the door.

Note: For some types of heating, the operation continues to run even when the appliance door is open.

Interior lighting

When you open the appliance door, the interior lighting switches on. If the door remains open for longer than around 15 minutes, the lighting switches off again.

In most operating modes, the interior lighting will switch on as soon as the appliance is started. Once the program is complete, the lighting switches off.

Note: You can set the interior lighting to not come on during the operation in the basic settings. → "Basic settings" on page 23

Cooling fan

The cooling fan switches on and off as required. The hot air escapes above the door.

Caution!

Do not cover the ventilation slots. Otherwise, the appliance may overheat.



To cool the cooking compartment more quickly after operation, the cooling fan continues to run for a certain period afterwards.

Note: You can change how long the cooling fan continues to run in the basic settings. → "Basic settings" on page 23

Water tank

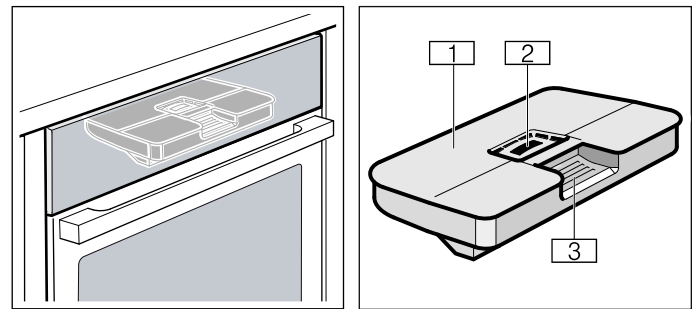
The appliance is fitted with a water tank. The water tank is behind the panel. For operations with steam, fill the water tank with water. → "Steam" on page 17



-  1 Tank cover
-  2 Filling opening
-  3 Handle for removing and inserting the water tank

Accessories

Your appliance is accompanied by a range of accessories. Here, you can find an overview of the accessories included and information on how to use them correctly.

Accessories included

Your appliance is equipped with the following accessories:

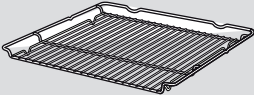
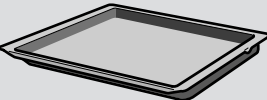
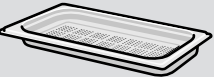
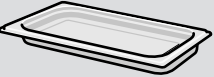
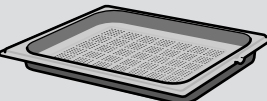
	<p>Wire rack For ovenware, cake tins and ovenproof dishes. For roasts, grilled items and frozen meals.</p>
	<p>Universal pan For moist cakes, other baked items, frozen meals and large roasts. It can be used to catch dripping fat when you are grilling directly on the wire rack. During operation with steam, it can also be used to catch drops of water.</p>
	<p>Steam container, perforated, size S For steaming vegetables, juicing berries and defrosting.</p>
	<p>Steam container, unperforated, size S For cooking rice, pulses and cereals.</p>
	<p>Steam container, perforated, size XL For steaming large quantities.</p>

Only use genuine accessories. They are specially adapted for your appliance.

You can buy accessories from the after-sales service, from specialist retailers or online.

Note: The accessories may become deformed when they become hot. This does not affect their function. Once they cool down again, they regain their original shape.

Note: You can use the steam container with all heating modes involving steam without any restrictions. If you set other heating modes at high temperatures, take the steam container out of the cooking compartment. High temperatures can cause permanent deformations and discolouration of the steam container.

Inserting accessories

The cooking compartment has three shelf positions. The shelf positions are counted from the bottom up.

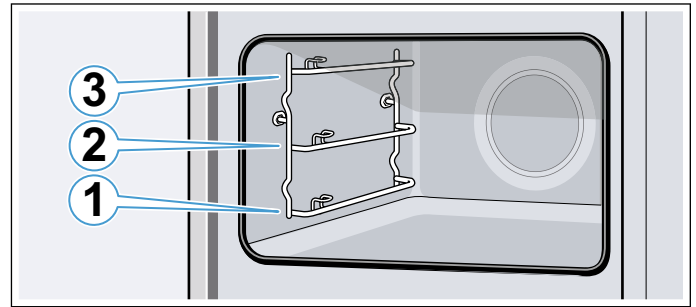

Locking function

The accessories can be pulled out approximately halfway until they lock in place. The locking function prevents the accessories from tilting when they are pulled out. The accessories must be inserted into the cooking compartment correctly for the tilt protection to work properly.

When inserting the wire rack, ensure that the lug **a** is at the rear and is facing downwards. The open side must be facing the appliance door and the curvature must be facing downwards.

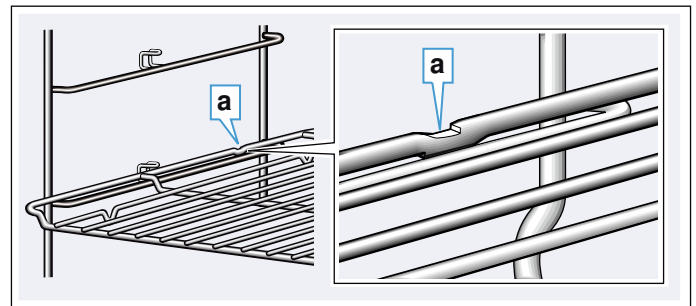

When inserting the baking tray or the universal pan, ensure that the lug **b** is at the rear and is facing downwards. The sloping edge of the accessory **c** must be facing towards the appliance door.

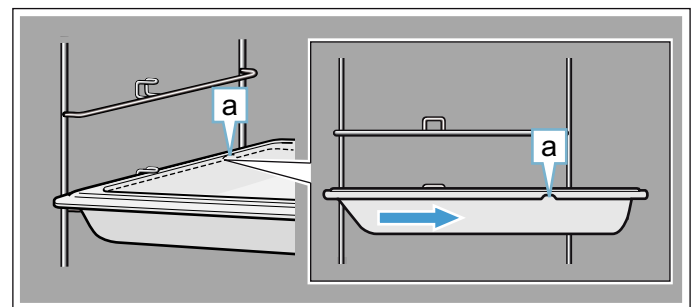

Combining accessories

You can insert the wire rack and the universal pan at the same time to catch drops of liquid.

When inserting the wire rack, ensure that both spacers **a** are at the rear edge. When the universal pan is inserted, the wire rack is on top of the upper guide rod of the shelf position.

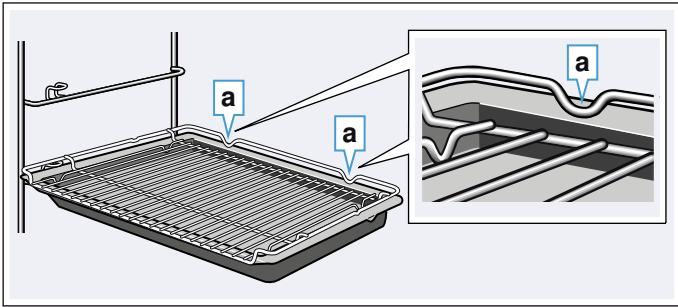

Small steam containers may only be placed in the cooking compartment with the wire rack.

Optional accessories

You can purchase optional accessories from the after-sales service and specialist retailers, or on the Internet. You will find a comprehensive range of products for your appliance in our brochures and on the Internet.

Both availability and whether it is possible to order online differ between countries. Please see your sales documents for more details.

Note: Not all optional accessories are suitable for every appliance. When purchasing, please always quote the exact designation (E no.) of your appliance.

→ "Customer service" on page 39

Optional accessories
Baking and roasting shelf, suitable for steaming
Baking tray
Universal pan
Baking tray, non-stick
Universal pan, non-stick
Extra-deep pan
Steam container, perforated, size XL
Steam container, perforated, size S
Steam container, unperforated, size S
Porcelain cooking container, unperforated, size S
Porcelain cooking container, unperforated, size L
Profi pan
Lid for the Profi pan
Pizza tray
Grill tray
Ceramic brick
Glass roasting dish, 5.1 litres
Glass pan
Decorative strip
ComfortFlex shelf (1 level) + frame*
ComfortFlex rail (1 level), suitable for steaming*

* Accessory does not fit in every appliance, quote the E no. when ordering

Before using for the first time

Before you can use your new appliance, you must make some settings. You must also clean the cooking compartment and accessories.

Initial use

As soon as the appliance is connected to the power supply, the first setting "Language" appears on the display.

Setting the language

1. Use the \vee button to navigate to the bottom line.
2. Use the \langle or \rangle button to select the language.
3. Use the \wedge button to return to "Language".
4. Use the \rangle button to select the next setting.

Set up Home Connect

1. Use the \vee button to navigate to the bottom line "Set with assistant".
2. Further instructions can be found in section → "Home Connect" on page 27

Setting the time

1. Use the \vee button to navigate to the bottom line.
2. Use the \langle or \rangle button to select the current hour.
3. Use the \vee button to navigate to the next line.
4. Use the \langle or \rangle button to select the current minute.
5. Press the \wedge button repeatedly until "Time" appears.
6. Use the \rangle button to select the next setting.

Setting the date

1. Use the \vee button to navigate to the bottom line.
2. Use the \langle or \rangle button to select the current day.
3. Use the \vee button to navigate to the next line.
4. Use the \langle or \rangle button to select the current month.
5. Use the \vee button to navigate to the next line.
6. Use the \langle or \rangle button to select the current year.
7. Press the \wedge button repeatedly until "Date" appears.
8. Use the \rangle button to select the next setting.

Setting the water hardness

1. Use the \vee button to navigate to the bottom line.
2. Use the \langle or \rangle button to select the water hardness range.
3. Use the \wedge button to return to "Water hardness".
4. Use the \rangle button to apply the settings.
The initial use is complete.

Notes

- You can change these settings at any time in the basic settings. → "Basic settings" on page 23
- After connecting the appliance to the power or following a power cut, the settings for initial use are shown in the display.

Calibrating the appliance and cleaning the cooking compartment

The boiling point of water depends on the air pressure. During calibration, the appliance self-adjusts to the pressure ratio at the installation location. This will happen automatically the first time steam-assisted cooking is used. This produces a lot of steam.

Preparing the appliance for calibration

1. Remove the accessories from the cooking compartment.
2. Remove any leftover packaging, such as polystyrene pellets, from the cooking compartment.
3. Before calibrating the appliance, wipe the smooth surfaces in the cooking compartment with a soft, damp cloth.

Calibrating the appliance and cleaning the cooking compartment

Notes

- Calibration cannot be started until the cooking compartment is cold (room temperature).
- Do not open the appliance door while calibration is in progress, as this will abort the calibration process.

1. Use the ① touch button to switch on the appliance.
2. Fill the water tank. → *"Filling the water tank" on page 18*
3. Set the specified type of heating, temperature and duration for the calibration, then start the appliance. → *"FullSteam – Steam cooking" on page 17*

Calibration	
Type of heating	Steam 
Temperature	100 °C
Cooking time	30 minutes

4. Heat up the appliance following calibration.

Caution!

Enamel damage

Do not use the appliance if there is water on the cooking compartment floor. Before using the appliance, wipe away the water from the cooking compartment floor.

5. Dry the cooking compartment floor.
6. Set the specified type of heating and temperature for heating, then start the appliance. → *"Setting and starting the appliance operation" on page 15*

Heating up	
Type of heating	CircoTherm 
Temperature	Maximum
Cooking time	30 minutes

7. Keep the kitchen ventilated while the appliance is heating.
8. Stop the appliance once the specified time has elapsed. Use the ① touch button to switch off the appliance.
9. Wait for the cooking compartment to cool down.

10. Clean the smooth surfaces with soapy water and a dish cloth.
11. Empty the water tank and dry the cooking compartment. → *"After every steam operation" on page 20*

Notes

- When relocating the appliance, restore its factory settings once it is installed so that it can adapt to its new location. Repeat the procedures for initial start-up and calibration.
- The appliance retains the calibration settings, even in the event of a power cut or disconnection from the mains. Calibration does not need to be repeated.

Cleaning the accessories

Clean the accessories thoroughly using soapy water and a dish cloth or soft brush.

Operating the appliance

You have already learnt about the controls and how they work. Now we will explain how to set your appliance. You will learn about what happens when you switch the appliance on and off, and how to select the operating mode.

Switching the appliance on and off

To switch the appliance on or off, touch the  touch button.

After the appliance has switched off, the display shows whether the residual heat in the cooking compartment is high or low.



Display	Temperature
Residual heat high	above 120 °C
Residual heat low	between 60 °C und 120 °C

Notes



- Certain indicators and instructions (e.g. about residual heat in the cooking compartment) remain visible on the display even when the appliance is switched off.
- After the appliance has completed an operation, you will hear the cooling fan continuing to run until the cooking compartment is cooled as much as possible.
- Switch off your appliance when you do not need to use it. If no settings are made for a long time, the appliance switches off automatically.

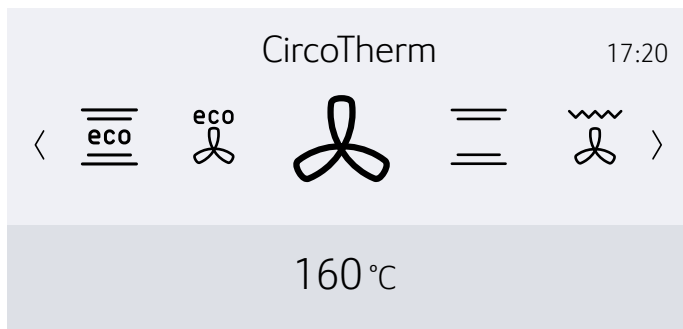

Setting and starting the appliance operation

Example: CircoTherm hot air  at 170 °C





1. Touch the  touch button to switch on the appliance.
You are taken directly to the  menu for the types of heating.

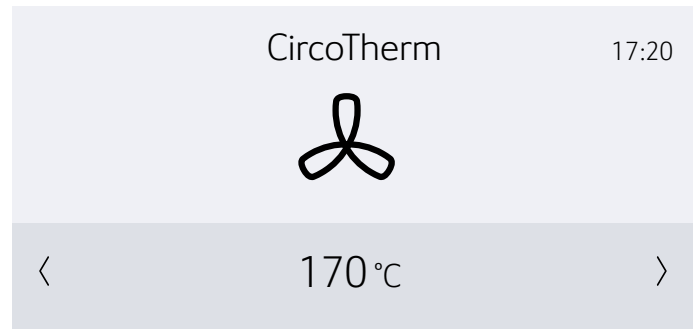

2. Use the  or  button to select the type of heating.
3. Use the  button to navigate to the next line.

4. Use the  or  button to select the temperature.



- Note:** Depending on the operating mode, different settings are available. For each further setting, use the  button to navigate to the next line. Use the  or  button to select the setting.
5. Touch the  touch button to start the appliance operation.
The heating bar and run time appear on the display.

Note: If you would like to go directly to the  main menu after switching on the appliance, you can select the main menu under "Operation after switching on" in the basic settings chapter.

Default values

The appliance suggests a temperature or setting for each type of heating. You can accept this value or change it in the appropriate area.

Heating bar

As soon as a type of heating has started, the heating bar appears on the display. The heating bar shows the temperature increase in the cooking compartment.

Run time



When a type of heating has been started, the run time is displayed. The run time counts upwards during the operation. You can therefore check how long the operation has already been running.

Displaying the current temperature

To show the current temperature on the display, press the  touch button.

The current temperature is shown briefly only when heating up.

Further information

If the  touch button lights up, information can be displayed. Touch the  touch button to do this. The information is displayed for a few seconds.

Changing or cancelling the appliance operation

Changing the appliance operation

1. Use the ▷|| button to stop the operation.
2. Use the ∨ or ∨ button to navigate to the line for the setting that should be changed.
3. Use the < or > button to change the setting.
4. Use the ▷|| touch button to start the changed operation.

Notes

- The cooling fan may continue to run while an operation is interrupted.
- After a temperature change, the paused running time continues to count. After a change in the type of heating, the running time starts again from zero.



Cancelling the appliance operation

Press and hold the ▷|| touch button until the appliance operation is cancelled.

Note: Operating modes such as the cleaning function cannot be cancelled.

Heating up the appliance quickly

You can use the "Rapid heat-up" and "PowerBoost" functions to reduce the preheat time. Whether the appliance is preheated with the "Rapid heat-up" function or the "PowerBoost" function depends on the type of heating that has been set. With the "PowerBoost" function, unlike with the "Rapid heat-up" function, you can place your food into the cold cooking compartment even before preheating has begun. Only cook on one level when using the "PowerBoost" function.

Function	Type of heating	Place the food in the cooking compartment
Rapid heat-up	Top/bottom heating 	after preheating
PowerBoost*	CircoTherm hot air  Bread-baking setting 	before preheating

* Do not use more than one level for cooking



Notes

- If the ⌘ touch button is lit, the "Rapid heat-up" or "PowerBoost" function can be activated.
- To deactivate the "Rapid heat-up" or "PowerBoost" function before it has finished, touch the ⌘ touch button.

Activating the "Rapid heat-up" function

1. Set top/bottom heating  and the temperature.
Note: Set a temperature above 100 °C to allow the appliance to preheat quickly.
2. Touch the ▷|| touch button to start the appliance operation.
3. Touch the ⌘ touch button to activate the "Rapid heat-up" function.
The ⌘ symbol appears on the display.
4. Once the set temperature has been reached, the "Rapid heat-up" function switches itself off automatically. The ⌘ symbol disappears from the display. Place the food in the cooking compartment

Activating the "PowerBoost" function

1. Set CircoTherm hot air  or the bread baking setting  and the temperature.
Note: Set a temperature above 100 °C to allow the appliance to preheat quickly.
2. Place the food on a single level in the cooking compartment.
3. Touch the ▷|| touch button to start the appliance operation.
4. Touch the ⌘ touch button to activate the "PowerBoost" function.
The ⌘ symbol appears on the display. Once the set temperature has been reached, the "PowerBoost" function switches itself off automatically. The ⌘ symbol disappears from the display.

Steam

Food can be cooked particularly gently using steam. With some heating modes, you can prepare food with steam assistance. In addition, the Dough proving, Defrost and Reheat heating modes are available.

Warning – Risk of scalding!

When you open the appliance door, hot steam can escape. Steam may not be visible, depending on its temperature. When opening, do not stand too close to the appliance. Open the appliance door carefully. Keep children away.

Noise

Pump

You will hear a humming noise while the pump is in operation and after switching it off. This noise is caused by the pump function test. It is a normal operating noise.

Control panel

You will hear a humming or clicking noise when opening the control panel. These noises are caused by the control panel being pushed out. They are normal operating noises.

FullSteam – Steam cooking











During steaming, hot steam surrounds the food and therefore prevents loss of nutrients from the food. The shape, colour and typical aroma of the dishes are retained as a result of this preparation method.

Note: If the water tank runs dry during steaming, operation is interrupted. Fill the water tank.

Starting

1. Touch the  touch button.
2. Fill the water tank.

Note: Only switch on steaming once the cooking compartment has cooled down completely (to room temperature).

3. Touch the  touch button.
4. Use the  or  button to select "Steaming .
5. Use the  button to navigate to the next line.
6. Use the  or  button to select the temperature.
7. Use the  button to navigate to the next line.
8. Use the  or  button to select the cooking time.
9. Touch the  touch button.

The appliance starts the operation.

As soon as the cooking time has elapsed, an audible signal sounds and the appliance ends the operation automatically. Touch the  touch button to end the audible signal.

Cancelling

Press and hold the  touch button until the appliance operation is cancelled.

Finishing

Touch the  touch button to switch the appliance off.

Menu cooking

With steam, you can cook a whole menu at once, without the different flavours mixing. → "Tested for you in our cooking studio" on page 39

VarioSteam – Steam-assisted cooking

When you cook with steam assistance, steam is introduced into the cooking compartment at various intervals and with varying degrees of intensity. This gives you a better cooking result.

Your food

- Becomes crispy on the outside
- Develops a shiny surface
- Is succulent and tender on the inside
- Only undergoes a minimum reduction in volume

You set the combination of heating mode and steam intensity that you want. Use the information in the tables to select a suitable heating mode and steam intensity. Alternatively, select a program from the steam programs. → "Tested for you in our cooking studio" on page 39 → "Programmes" on page 25





Steam intensity

Different intensity levels are available when adding steam:







- Low
- Medium
- High

Suitable heating modes

You can switch on steam assistance for these heating modes:

- CircoTherm hot air 
- Top/bottom heating 
- Circo-roasting 
- Bread-baking 
- Keeping warm 

Starting

1. Touch the  touch button.
2. Refill the water tank.
3. Set the heating mode and temperature.
4. Touch the  touch button to switch on steam assistance.
5. Use the  button to navigate to the line with steam assistance .
6. Use the  or  button to select the steam intensity.
7. Touch the  touch button.
The appliance starts the operation.

Note: If the water tank runs dry during an operation with steam assistance, a message appears on the display prompting you to fill up the water tank. The operation continues without adding steam.

Cancelling steam addition

Touch the  touch button to cancel the addition of steam early.

Note: The operation continues without adding steam.

Cancelling appliance operation

Press and hold the ▷|| touch button until the appliance operation is cancelled.

Finishing

Touch the ⓪ touch button to switch the appliance off.

Dough proving setting

Dough will prove considerably more quickly using the "Dough proving ☰" heating mode than at room temperature and does not dry out.

There are two levels available for the Dough proving setting. Use the information in the tables to select the appropriate level. → *"Tested for you in our cooking studio" on page 39*

Note: If the water tank runs dry during operation with the Dough proving setting, operation is interrupted. Fill the water tank.

Starting

1. Touch the ⓪ touch button.
2. Refill the water tank.

Note: Only switch on Dough proving once the cooking compartment has completely cooled down (to room temperature).

3. Use the < or > button to select "Dough proving ☰".
4. Use the ∨ button to navigate to the next line.
5. Use the < or > button to select the level.
6. Use the ∨ button to navigate to the next line.
7. Use the < or > button to select the cooking time.
8. Touch the ▷|| touch button.

The appliance starts the operation.

As soon as the cooking time has elapsed, an audible signal sounds and the appliance ends the operation automatically. Touch the ⓪ touch button to end the audible signal.

Cancelling

Press and hold the ▷|| touch button until the appliance operation is cancelled.

Finishing

Touch the ⓪ touch button to switch the appliance off.

Defrost setting

Use the "Defrost ☼" heating mode to defrost frozen products.

Note: If the water tank runs dry during operation with the Defrost setting, operation is interrupted. Fill the water tank.

Starting

1. Touch the ⓪ touch button.
2. Refill the water tank.
3. Use the < or > button to select "Defrost ☼".
4. Use the ∨ button to navigate to the next line.
5. Use the < or > button to select the temperature.

6. Use the ∨ button to navigate to the next line.
7. Use the < or > button to select the cooking time.
8. Touch the ▷|| touch button.
The appliance starts the operation.

As soon as the cooking time has elapsed, an audible signal sounds and the appliance ends the operation automatically. Touch the ⓪ touch button to end the audible signal.

Cancelling

Press and hold the ▷|| touch button until the appliance operation is cancelled.

Finishing

Touch the ⓪ touch button to switch the appliance off.

Reheating

With the "Reheat ☰" heating mode, you can gently reheat food that has already been cooked or crisp up day-old baked goods. Steam is switched on automatically.

Note: If the water tank runs dry during operation with the Reheat setting, operation is interrupted. Fill the water tank.

Starting

1. Touch the ⓪ touch button.
2. Refill the water tank.
3. Use the < or > button to select "Reheat ☰".
4. Use the ∨ button to navigate to the next line.
5. Use the < or > button to select the temperature.
6. Use the ∨ button to navigate to the next line.
7. Use the < or > button to select the cooking time.
8. Touch the ▷|| touch button.
The appliance starts the operation.

As soon as the cooking time has elapsed, an audible signal sounds and the appliance ends the operation automatically. Touch the ⓪ touch button to end the audible signal.

Cancelling

Press and hold the ▷|| touch button until the appliance operation is cancelled.

Finishing

Touch the ⓪ touch button to switch the appliance off.

Filling the water tank

The water tank is located behind the control panel. Before starting an operation with steam, open the control panel and fill the water tank with water.

Make sure that you have set the water hardness range correctly. → *"Basic settings" on page 23*

Warning – Risk of injury and risk of fire!

Only fill the water tank with water or with the descaling solution that is recommended by us. Do not pour any flammable liquids (e.g. alcoholic drinks) into the water tank. Due to hot surfaces, vapours from flammable

liquids may catch fire in the cooking compartment (explosion). The appliance door may spring open. Hot steam and jets of flame may escape.

⚠ Warning – Risk of burns!

The water tank may heat up while the appliance is in operation. Wait until the water tank has cooled down after the previous appliance operation. Remove the water tank from the water tank recess.

Caution!

The appliance may become damaged due to the use of unsuitable liquids.

Do not use distilled water, highly chlorinated tap water (> 40 mg/l) or other liquids.

Only use cold, fresh tap water, softened water or uncarbonated mineral water.

Caution!

Malfunctions may occur when using filtered or demineralised water.

The appliance may request that you top up the water tank even though it may be full, or operation with steam is cancelled after approx. two minutes.

If required, mix filtered or demineralised water with the bottled non-carbonated mineral water with a ratio of one to one.

Notes

- If your water is very hard, we recommend that you use softened water.
- If you use only softened water, you can set your appliance to the "softened" water hardness range.
- If you use mineral water, set the water hardness range to "4 very hard".
- If you use mineral water, you must only use non-carbonated mineral water.

1. Touch the  touch button. The control panel is pushed forwards automatically.
2. Pull the control panel forwards with both hands and then push it upwards until it locks into place (Fig. 1).
3. Lift the water tank and remove it from the water tank recess (Fig. 2).

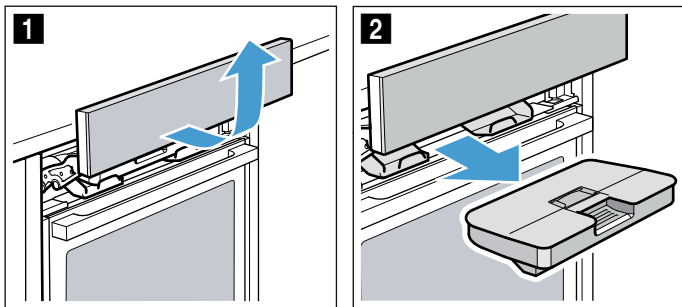

4. Press down on the cover along the seal to prevent water from leaking out of the water tank.

5. Take out the cover **a** (Fig. 3).

Note: Whether or not there is a cover **a** depends on the appliance type.

6. Fill the water tank with cold water up to the "max." mark (Fig. 4).

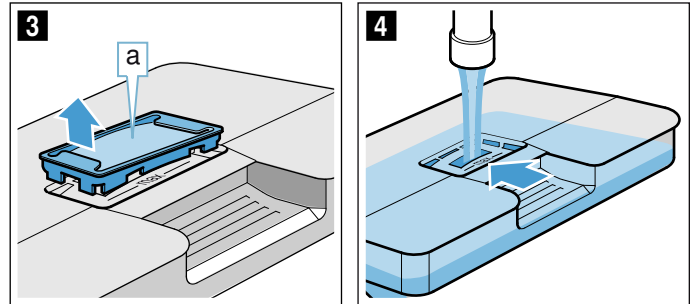

7. Put the cover **a** back into the opening on the water tank.

8. Insert the filled water tank (Fig. 5). Ensure that the water tank locks into place behind both holders **b** (Fig. 6).

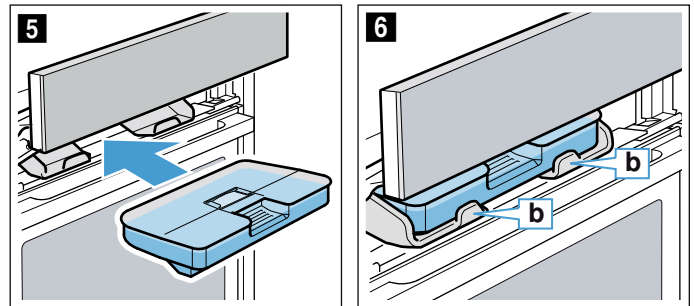

9. Slowly slide the control panel downwards and then push it towards the rear until it is closed completely. The water tank has been filled. You can start using operating modes with steam.

Refilling the water tank

Notes

- Steam-assisted operations continue without adding steam.
- If the water tank runs dry during operation with the Steaming, Dough proving, Defrost or Reheat settings, operation is interrupted. Fill the water tank.

1. Open the control panel.
2. Remove and refill the water tank.
3. Insert the filled water tank and close the control panel.

After every steam operation

⚠ Warning – Risk of scalding!

When you open the appliance door, hot steam can escape. Steam may not be visible, depending on its temperature. When opening, do not stand too close to the appliance. Open the appliance door carefully. Keep children away.

⚠ Warning – Risk of burns!

The appliance becomes hot during operation. Allow the appliance to cool down before cleaning.

Caution!

Enamel damage: Do not start any operations when there is water on the cooking compartment floor. Before operation, wipe away the water from the cooking compartment floor.

The remaining water is pumped back into the water tank after every operation with steam. Then empty and dry the water tank. Moisture remains in the cooking compartment. To dry the cooking compartment, you can either use the "Drying ☺" operating mode or dry the cooking compartment by hand.

Notes

- Once the appliance has been switched off, the  touch button remains lit for a little longer to remind you to empty the water tank.
- Remove limescale marks with a cloth soaked in vinegar, then wipe with clean water and dry with a soft cloth.

Emptying the water tank

Caution!

- Do not dry the water tank in the hot cooking compartment. This will damage the water tank.
- Do not clean the water tank in the dishwasher. This will damage the water tank.

1. Open the control panel.
2. Remove water tank.
3. Carefully remove the lid of the water tank.
4. Empty the water tank, clean it with detergent and then rinse it thoroughly with clean water.
5. Dry all parts with a soft cloth.
6. Rub the seal on the lid until dry.
7. Leave to dry with the lid open.
8. Place the lid on the water tank and push it down.
9. Insert the water tank and close the control panel.

Cleaning the drip trough

1. Allow the appliance to cool down.
2. Open the appliance door.
3. Soak up the water in the drip trough **a** with a sponge cloth and wipe it carefully (figure **1**). When you wipe it, be careful not to detach the seal **b** from the drip trough (figure **2**).

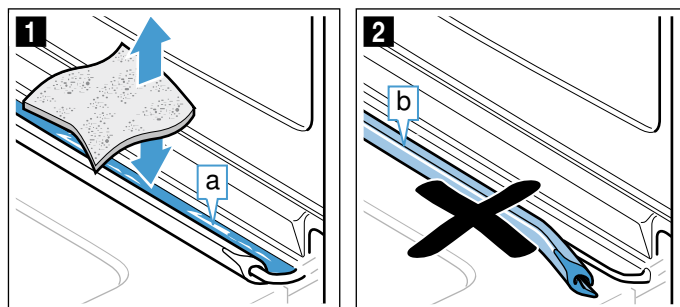

The drip trough **a** is located below the cooking compartment (figure **3**).

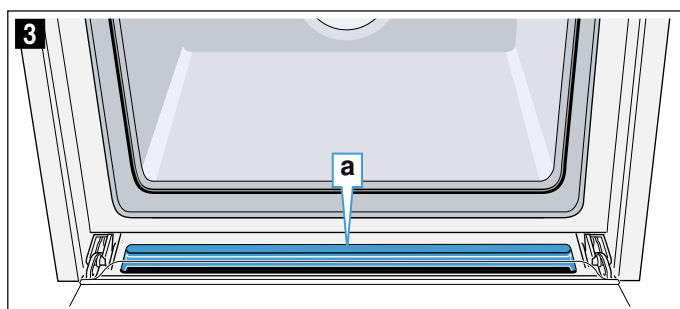







Note: If the seal has become detached, fit the seal back onto the drip trough. → "Appliance door" on page 34

Starting drying

To dry the cooking compartment, it is heated up so that the moisture in the cooking compartment evaporates. You will then need to open the appliance door to allow the steam to escape from the cooking compartment.

Caution!

Enamel damage: Do not start any operations when there is water on the cooking compartment floor. Before operation, wipe away the water from the cooking compartment floor.



1. Leave the appliance to cool down.
2. Remove the worst dirt from the cooking compartment immediately and wipe away moisture from the cooking compartment floor.
3. If necessary, touch the  touch button to switch the appliance on.
4. Touch the  touch button to display the operating modes.
5. Use the  or  button to select "Drying ☺".
6. Use the  button to navigate to the next line. The duration is displayed. It cannot be changed.
7. Use the  button to navigate to the next line.
8. Touch the  touch button. The drying function is started and is ended automatically after 10 minutes.
9. Open the appliance door and leave it open for 1 to 2 minutes so that the moisture in the cooking compartment can escape.

Drying the cooking compartment by hand

1. Allow the appliance to cool down.
2. Remove any food remnants from the walls of the cooking compartment.
3. Dry the cooking compartment with a sponge.
4. Leave the appliance door open for 1 hour so that the cooking compartment dries completely.

Time-setting options

Your appliance has different time-setting options.



Time-setting option	Use
 Timer	The timer functions like an egg timer. The appliance does not switch on and off automatically.
 Cooking time	Once the set cooking time has elapsed, the appliance switches off automatically.
 Ready at	The appliance switches on automatically, and once the set cooking time has elapsed and the end time has passed, it switches off automatically.

Note: If you have set a time-setting option, the time interval increases if you set a higher value. Example: You can set a cooking time of up to one hour in one-minute increments; for cooking times over one hour, you can set a cooking time in five-minute increments.

Showing and hiding the time-setting options





To show or hide the time-setting options, touch the  touch button.

Note: After a particular length of time, the time-setting options that are shown are automatically hidden. If you have already set a cooking time, it will be applied.

 Timer	--:-- min s >
 Cooking time	--:-- h min
 Ready at	17:20

Setting the timer



The timer can be set when the appliance is switched on or off.

1. Touch the  touch button.
The time-setting options are shown on the display.
2. Select the cooking time using the > button.
Note: When the appliance is switched on, use the  button to navigate to the Timer  line and then select the cooking time using the > button.
3. Touch the  touch button to start the timer.
The  symbol appears on the display. The timer counts down.

Note: As soon as the set time has elapsed, a signal sounds. To cancel the signal tone, touch the  touch button.

Setting the cooking time

Once the set cooking time has elapsed, the appliance switches off automatically. The function can only be used in combination with a type of heating.

1. Touch the  touch button.
2. Set the type of heating and temperature.
3. Touch the  touch button.
The time-setting options are shown in the display.
4. Use the < or > button to set the cooking time.
 - Default value for the < button = 10 minutes
 - Default value for the > button = 30 minutes
5. Touch the  touch button to start the set cooking time.





As soon as the cooking time has elapsed, an audible signal sounds and the appliance ends the operation automatically. Touch the  touch button to end the audible signal.

Start delay – "Ready at"

The appliance switches on automatically and switches off at the preset end time. To do this, set the cooking time and determine the end time for the operation.



The start delay can only be used in combination with a type of heating.

Notes

- Ensure that food is not left in the cooking compartment for too long as it may spoil.
 - It is not possible to start every type of heating with a start delay.
1. Slide food into the cooking compartment on a suitable accessory and close the appliance door.
 2. Touch the  touch button.
 3. Set the type of heating and temperature.
 4. Touch the  touch button.
The time-setting options are shown on the display.
 5. Select the cooking time using the > button.
 6. Use the  button to navigate to the " Ready at" line.
 7. Select the end time using the > button.
 8. Touch the  touch button.
The appliance waits until the appropriate time to start the operation.

As soon as the end time has passed, a signal sounds and the appliance stops the operation automatically. To cancel the signal tone, touch the  touch button.

Checking, changing or deleting settings



1. Touch the  touch button.
The time-setting options are shown on the display.
2. Use the  or  button to navigate through the lines.
3. If necessary, change the setting using the < or > button. Set "00:00" to delete a time function.
The setting is applied automatically.

Childproof lock

Your appliance is equipped with a childproof lock so that children cannot switch it on accidentally or change any settings.

Your appliance has two different locks.













Lock	Activate/deactivate
Automatic childproof lock	Via the MyProfile menu → "Basic settings" on page 23
One-time childproof lock	Via the  touch button

Note: As soon as you activate the childproof lock, the control panel is locked. The  and  touch buttons are not included. You can deactivate the childproof lock at any time.



Automatic childproof lock

The control panel is locked so that the appliance cannot be switched on. To switch it on, the automatic childproof lock must be interrupted. After the appliance operation, the control panel is locked automatically.













Activating

1. Touch the  touch button.
2. Touch the  touch button.
3. Use the  or  button to select "MyProfile".
4. Use the  button to navigate to the next line.
5. Use the  or  button to select "Automatic childproof lock".
6. Use the  button to navigate to the bottom line.
7. Use the  button to select "Activated".
8. Touch the  touch button.
9. Use the  button to navigate to the next line to save the setting.
The "Automatic childproof lock" is activated. The  symbol appears on the display after switching off the appliance.

Cancelling

1. Press and hold the  touch button until "Childproof lock deactivated" appears on the display.
2. Touch the  touch button.
3. Switch on the required appliance operation.



Deactivating

1. Press and hold the  touch button until "Childproof lock deactivated" appears on the display.
2. Touch the  touch button.
3. Touch the  touch button.
4. Use the  or  button to select "MyProfile".
5. Use the  button to navigate to the next line.
6. Use the  or  button to select "Automatic childproof lock".
7. Use the  button to navigate to the bottom line.
8. Use the  button to select "Deactivated".
9. Touch the  touch button.
10. Use the  button to navigate to the next line to save the setting.
The "Automatic childproof lock" is deactivated.
11. Touch the  touch button.

One-time childproof lock

The control panel is locked so that the appliance cannot be switched on. To switch it on, the one-time childproof lock must be deactivated. After the appliance is switched off, the control panel is no longer locked.















Activating and deactivating

1. Press and hold the  touch button until "Childproof lock activated" appears on the display.
The childproof lock is activated.
2. Press and hold the  touch button until "Childproof lock deactivated" appears on the display.
The childproof lock is deactivated.

Basic settings

There are various settings available to you in order to help use your appliance effectively and simply. If necessary, you can change these settings in MyProfile .

Changing MyProfile

1. Touch the  touch button.
2. Touch the  touch button.
3. Use the  or  button to select "MyProfile .
4. Use the  button to navigate to the next line.
5. Use the  or  button to select the setting.
6. Use the  button to navigate to the selection.
7. Use the  or  button to select the setting.
8. Touch the  touch button.
9. To save the setting, use the  button to select "Save".
To discard the setting, use the  button to select "Discard".

List of basic settings















Setting	Selection
Language	Select language
Time of day	Sets the current time
Date	Sets the current date
Water hardness	0 (softened)
	1 (soft)
	2 (medium)
	3 (hard)
	4 (very hard)
Favourites	Set the heating types that should be shown in the heating types menu
Audible signal	Short duration
	Medium duration
	Long duration
Button tone	Switched off (Exception: The button tone for the  touch button remains switched on)
	Switched on
Display brightness	Adjustable across 5 levels
Clock display	Digital
	Off
Lighting	On during operation
	Off during operation
Childproof lock*	Only key lock
	Door lock and key lock
Automatic childproof lock	Deactivated
	Activated

Action after switching on	Main menu
	Heating types
	Steam
	Baking and roasting assistant
	Steam programmes
Night-time dimming	Switched off
	Switched on (display dimmed between 10 p.m. and 5.59 a.m.)
Brand name logo	Display
	Do not display
Fan run-on time	Recommended
	Minimum
Pull-out system*	Not retrofitted (rack)
	Retrofitted (single pull-out)
Home Connect	Switching WiFi on or off → "Home Connect" on page 27
	Establishing a connection via Home Connect
Factory settings	Restore
*) Depending on the appliance model, this basic setting cannot be selected	



Setting favourites

You can set which heating types are shown in the heating types menu.

Note: The "CircoTherm hot air", "Circo-roasting" and "Grill, large area" heating types are always shown in the heating types menu. They cannot be deactivated.

1. Touch the  touch button.
2. Touch the  touch button.
3. Use the  or  button to select "MyProfile .
4. Use the  button to navigate to the next line.
5. Use the  or  button to select "Favourites".
6. Use the  button to select "Setting favourites".
7. Use the  or  button to select the heating type.
8. Use the  button to navigate to the next line.
9. Use the  or  button to select "Activated" or "Deactivated".

Note: If you have selected "Activated", the heating type is shown in the heating types menu. If you have selected "Deactivated", the heating type is not shown in the heating types menu.

10. Touch the  touch button.
11. To save the setting, use the  button to select "Save".
To discard the setting, use the  button to select "Discard".

Baking and roasting assistant

The baking and roasting assistant helps you to prepare meals with ease. The appliance applies the most suitable settings.

To achieve good results, the cooking compartment must not be too hot for the type of food you have selected. If it is, a message will appear on the display. Allow the cooking compartment to cool down and start again.

Information on the settings

- The cooking result depends on the quality of the food and the type of cookware. For an optimal cooking result, use food that is in good condition and chilled meat only.
- The baking and roasting assistant helps you to prepare classic cakes, bread and roasts. The appliance selects the optimal type of heating for you. It suggests a suitable temperature and cooking time, which you can change if you wish.
- Information is provided, e.g. on cookware, shelf position or the addition of liquid when cooking meat. Some food requires turning or stirring, etc. during cooking. This is shown in the display shortly after operation starts. An audible signal will remind you at the right time.
- Information on the right kind of cookware to use and tips and tricks for preparation can be found at the end of the instruction manual.

Selecting a meal



















The following table shows the corresponding setting values for the listed meals.

Dishes
Rich fruit cake
Victoria sponge cake
Victoria sponge cake, on two levels
Swiss roll
Jam tarts
Jam tarts, on two levels
Fruit crumble
Pavlova
Vol au vents
Small cakes
Small cakes, on two levels
White bread
Scones
Scones, on two levels
Pizza, frozen
Oven chips
Baked potatoes
Baked potatoes, on two levels

Dishes
Lasagne, chilled
Roast pork
Top rump
Slow roasting joint
Leg of lamb
Whole chicken
Chicken drumsticks
Duck

Setting the food

You will be guided through the entire setting process for your chosen food.

1. Touch the  touch button to switch on the appliance.
2. Touch the  touch button.
3. Use the  or  button to select the "Baking and roasting assistant".
4. Use the  button to navigate to the next line.
5. Use the  or  button to select the required category.
6. Use the  button to navigate to the next line.
7. Use the  or  button to select the required meal.
8. Use the  button to navigate to the next line. The recommended settings appear on the display.
Note: For some meals, you can also display notes, e.g. on the shelf height and cookware. Touch the  button to do this. To return to the recommended settings, touch the  button.
9. If required, you can change the recommended settings. Touch the  button to do this. Use the  or  button to navigate to the required setting. Use the  or  button to adjust the setting.
10. Touch the  touch button to start the appliance operation.





As soon as the cooking time has elapsed, an audible signal sounds and the appliance ends the operation automatically. Touch the  touch button to end the audible signal.

Some recommended settings offer you the opportunity to continue cooking your dish.

When you are happy with the cooking result, use the  button to select "End".

If you are not happy with the cooking result, you can continue cooking your dish.

Continue cooking

1. Use the  button to select "Continue cooking".
2. If necessary, use the  or  button to change the recommended setting.
3. Touch the  touch button to start "Continue cooking".

Cancelling

Press and hold the  touch button until the appliance operation is cancelled.

Switching off the appliance

Touch the ① touch button to switch off the appliance.

Programmes

You can prepare food very easily using the various programmes. You select a programme and enter the weight of your food. The program then applies the most suitable settings.

To achieve good results, the cooking compartment must not be too hot for the type of food you have selected. If it is, a message will appear on the display. Allow the cooking compartment to cool down and start again.

Information on the settings

- The cooking result depends on the quality of the food and the type of cookware used. For best results, only use high-quality food and refrigerated meat. For frozen products, only use food directly from the freezer.
- For some dishes, you will be required to enter the weight. The appliance will then apply the time and temperature settings for you. It is not possible to set weights outside the intended weight range.
- For roasting programmes, for which the appliance applies the temperature selection, temperatures can be as high as 300 °C. Therefore ensure that you are using heat-resistant cookware.
- Information about cookware, shelf position or adding liquid for meat is provided for you. For some dishes, the food needs to be turned or stirred during cooking. This is shown briefly on the display after the start. A signal reminds you to do this at the right time.
- Information about suitable cookware and preparation tips and tricks can be found at the end of the instruction manual.

Steam

For the steam programme, the appliance provides you with programmes you can use to prepare your meals easily and professionally.

Information about the steam functions can be found in the relevant sections. → "Steam" on page 17

Warning – Risk of scalding!

When you open the appliance door, hot steam can escape. Steam may not be visible, depending on its temperature. When opening, do not stand too close to the appliance. Open the appliance door carefully. Keep children away.











Selecting a dish









The following table shows the corresponding setting values for the listed dishes.

Food
White bread, without a tin
Wheat bread, multi-grain wheat bread in a loaf tin
Flatbread
Plaited loaf, unfilled/savarin
Sponge cake
Pork neck joint, boned
Top side, top rump
Leg of lamb
Chicken, whole, fresh
Chicken portions, fresh
Chicken breast, steam
Goose, duck, unstuffed, fresh
Fish fillet, au gratin
Fish fillet, braise
Fish, whole
Fish, whole, steam
Cauliflower florets, steam
Broccoli florets, steam
Green beans, steam
Sliced carrots, steam
Vegetables, frozen
Basmati rice
Brown rice
Couscous
Cooked side dishes, reheat
Chicken breast
Fish fillet, fresh
Rice pudding
Fruit compote
Eggs, soft-boiled
Eggs, hard-boiled
Bottles, sterilise

Setting a programme

You will be guided through the entire setting process for your chosen food.

1. Touch the  touch button to switch on the appliance.
2. Touch the  touch button.
3. Use the  or  button to select "Steam programmes".
4. Use the  button to navigate to the next line.
5. Use the  or  button to select the required meal category.
6. Use the  button to navigate to the next line.
7. Use the  or  button to select the required steam programme.





8. Use the  button to navigate to the next line. The settings for this dish appear on the display.
Note: For some meals, you can also display notes, e.g. on the shelf height and cookware. Touch the  button to do this. To return to the settings, touch the  button.
 9. If required, you can adjust the weight for some meals. Touch the  button to do this. Use the  or  button to set the weight.
 10. Touch the  touch button to start the appliance operation. The estimated cooking time is shown.
Note: For some programmes, the displayed cooking time may change during the first few minutes, as the heating-up time depends on the temperature of the food and the water, amongst other things.
- As soon as the cooking time has elapsed, an audible signal sounds and the appliance ends the operation automatically. Touch the  touch button to end the audible signal.

Some programmes offer you the opportunity to continue cooking your dish.

When you are happy with the cooking result, use the  button to select "End".

If you are not happy with the cooking result, you can continue cooking your dish.

Continue cooking

1. Use the  button to select "Continue cooking".
2. If necessary, use the  or  button to change the recommended setting.
3. Touch the  touch button to start "Continue cooking".

Cancelling

Press and hold the  touch button until the appliance operation is cancelled.

Switching off the appliance

Touch the  touch button to switch off the appliance.

Sabbath mode











You can set a time of up to 74 hours using Sabbath mode. The food in the cooking compartment remains warm, without you having to switch the appliance on or off.

Starting Sabbath mode

Before you can use Sabbath mode, you must activate it under "Favourites" in the basic settings.

Once the Sabbath mode has been activated, you can select it under the menu for the types of heating.

The appliance heats up with top/bottom heating. The temperature can be set between 85 °C and 140 °C.

1. Touch the  touch button.
2. Use the  or  button to select "Sabbath mode".
3. Use the  button to navigate to the next line.
4. Use the  or  button to select the temperature.
5. Use the  button to navigate to the next line.
6. Use the  or  button to select the cooking time.
7. Touch the  touch button.

The appliance starts the operation.

Notes

- Once Sabbath mode has started, you can no longer change any settings or cancel the operation using the  touch button.
- The operation is not interrupted if you open the appliance door.

Once the Sabbath mode duration has elapsed, a signal sounds. The appliance stops heating. Use the  touch button to switch off the appliance.

Cancelling Sabbath mode

Touch the  touch button to cancel Sabbath mode.

Home Connect

This appliance is Wi-Fi-capable and can be remotely controlled using a mobile device.

If the appliance is not connected to the home network, the appliance functions in the same way as an oven with no network connection and can still be operated via the display.

The availability of the Home Connect function depends on the availability of Home Connect services in your country. Home Connect services are not available in every country. You can find more information on this at www.home-connect.com.

Notes

- Ensure that you follow the safety instructions in this instruction manual and that you comply with these even when you are away from home and are operating the appliance via the Home Connect app. You must also follow the instructions in the Home Connect app. → *"Important safety information" on page 5*
- Operating the appliance directly from the appliance always has priority. During this time, it is not possible to operate the appliance using the Home Connect app.

Setting up

To set up Home Connect for your appliance, you require the following:

- Your appliance, which must be connected to the mains and switched on,
- A smartphone or tablet with the latest version of the iOS or Android operating system,
- The Home Connect app,
- The supplied Home Connect installation instructions,
- And your appliance within range of the Wi-Fi signal for your home network

The app guides you through the entire process. Follow the instructions in the app.

Remote Start

In order to start and operate your appliance via the Home Connect app, you must activate remote start. If remote start has been deactivated, you can only display the operating statuses in the Home Connect app and implement appliance settings.







Note: Some of the operating modes can only be started on the oven.

Remote start is automatically deactivated:

- if you open the oven door 15 minutes after remote start has been activated.
- if you open the oven door 15 minutes after the end of operation.

When you start the oven using the controls on the appliance itself, remote start is automatically activated. You can now make changes or start a new programme from your mobile device.

Activating remote start

1. Touch the  touch button to switch on the appliance.
2. Touch the  touch button. The main menu appears.
3. Use the  or  button to select "Remote start" .
4. Press the  button to activate remote start.  appears in the display.

Home Connect settings

You can adjust Home Connect to suit your requirements at any time.

Note: You will find the Home Connect settings in the basic settings for your appliance. Which settings the display shows will depend on whether Home Connect has been set up and whether the appliance is connected to your home network.

Basic setting	Possible settings	Explanation
Wi-Fi	Switching on/off	You can switch the radio module on and off. If Wi-Fi has been activated, you can use the Home Connect functions. In networked standby mode, the appliance requires max. 2 W.
Network	Connecting to the network/disconnecting from the network	Switch the network connection on or off as required (e.g. for holiday). The network information is retained after the appliance is switched off. After switching on the appliance, wait for a few seconds while it reconnects to the network.
Connect to app		Start the connection process between the app and the appliance.
Remote control	On/off	Access the appliance's functions via the Home Connect app. When deactivated, only the appliance's operating statuses will be displayed in the app.
Appliance information 		The display shows the network and appliance information.

Remote diagnostics

If a fault occurs, the after-sales service can use remote diagnostics to access your appliance.

Contact the after-sales service, making sure that your appliance is connected to the Home Connect server and checking that the remote diagnostics service is available in your country.

Note: For more information and to check whether the remote diagnostics service is available in your country, please visit the Help & Support area of the Home Connect website for your country: www.home-connect.com

About data protection

When your appliance is connected for the first time to a WLAN network, which is connected to the Internet, your appliance transmits the following categories of data to the Home Connect server (initial registration):

- Unique appliance identification (consisting of appliance codes as well as the MAC address of the installed WiFi communication module).
- Security certificate of the WiFi communication module (to ensure a secure IT connection).
- The current software and hardware version of your domestic appliance.
- Status of any previous resetting to factory settings.

This initial registration prepares the Home Connect functions for use and is only required when you want to use these Home Connect functions for the first time.

Note: Ensure that the Home Connect functions can be used only in conjunction with the Home Connect app. Information on data protection can be accessed in the Home Connect app.

Declaration of Conformity

Constructa Neff Vertriebs-GmbH hereby declares that the appliance with functionality meets the basic requirements and other relevant provisions of Directive 2014/53/EU.

A detailed RED Declaration of Conformity can be found online at www.neff-international.com among the additional documents on the product page for your appliance.



2.4 GHz band: max. 100 mW
5 GHz band: max. 100 mW

	BE	BG	CZ	DK	DE	EE	IE	EL
	ES	FR	HR	IT	CY	LV	LT	LU
	HU	MT	NL	AT	PL	PT	RO	SI
	SK	FI	SE	UK	NO	CH	TR	
5 GHz Wi-Fi: for indoor use only								

Cleaning agent

With good care and cleaning, your appliance will retain its appearance and remain fully functioning for a long time to come. We will explain here how you should correctly care for and clean your appliance.

Suitable cleaning agents

To ensure that the different surfaces are not damaged by using the wrong cleaning agent, observe the information in the table. Depending on the appliance model, not all of the areas listed may be on/in your appliance.

Caution!

Risk of surface damage

Do not use:

- Harsh or abrasive cleaning agents,
- Cleaning agents with a high alcohol content,
- Hard scouring pads or cleaning sponges,
- High-pressure cleaners or steam cleaners,
- Special cleaners for cleaning the appliance while it is hot.

Wash new sponge cloths thoroughly before use.

Tip: Highly recommended cleaning and care products can be purchased through the after-sales service. Observe the respective manufacturer's instructions.

Warning – Risk of burns!

The appliance becomes very hot. Never touch the interior surfaces of the cooking compartment or the heating elements. Always allow the appliance to cool down. Keep children at a safe distance.

Area	Cleaning
Appliance exterior	
Stainless steel front	Hot soapy water: Clean with a dish cloth and then dry with a soft cloth. Remove flecks of limescale, grease, starch and albumin (e.g. egg white) immediately. Corrosion can form under such flecks. Special stainless steel cleaning products suitable for hot surfaces are available from our after-sales service or from specialist retailers. Apply a very thin layer of the cleaning product with a soft cloth.
Plastic	Hot soapy water: Clean with a dish cloth and then dry with a soft cloth. Do not use glass cleaner or a glass scraper.
Painted surfaces	Hot soapy water: Clean with a dish cloth and then dry with a soft cloth.
Control panel	Hot soapy water: Clean with a dish cloth and dry with a soft cloth. Do not use glass cleaner or a glass scraper. If descaler comes into contact with the control panel, wipe it off immediately. If you leave it, it may stain the control panel.

Door panels	Hot soapy water: Clean with a dish cloth and then dry with a soft cloth. Do not use a glass scraper or a stainless steel scouring pad.
Door handle	Hot soapy water: Clean with a dish cloth and then dry with a soft cloth. If descaler comes into contact with the door handle, wipe it off immediately. Otherwise, any stains will not be able to be removed.
Appliance interior	
Enamel surfaces and self-cleaning surfaces	Observe the instructions for the surfaces of the cooking compartment that follow the table.
Glass cover for the interior lighting	Hot soapy water: Clean with a dish cloth and then dry with a soft cloth. If the cooking compartment is heavily soiled, use oven cleaner.
Door seal Do not remove.	Hot soapy water: Clean with a dish cloth. Do not scour.
Door cover	made from stainless steel: Use stainless steel cleaner. Follow the manufacturers' instructions. Do not use stainless steel care products. made from plastic: Clean using hot soapy water and a dish cloth. Dry with a soft cloth. Do not use glass cleaner or a glass scraper. Remove the door cover for cleaning.
Rails	Hot soapy water: Soak and clean with a dish cloth or brush.
Pull-out system	Hot soapy water: Clean with a dish cloth or a brush. Do not remove the lubricant while the pull-out rails are pulled out – it is best to clean them when they are pushed in. Do not clean in the dishwasher.
Accessories	Hot soapy water: Soak and clean with a dish cloth or brush. Clean dirt on stainless steel roasting dishes caused by starchy foods (e.g. rice) using a vinegar solution.
Water tank	Hot soapy water: Clean with a dish cloth and rinse thoroughly to remove residual detergent. Then dry with a soft cloth. Leave the water tank to dry with the lid open. Rub the seal on the lid until dry. Do not clean in the dishwasher.

Notes

- Slight differences in colour on the front of the appliance are caused by the use of different materials, such as glass, plastic and metal.
- Shadows on the door panels, which look like streaks, are caused by reflections made by the interior lighting.
- Enamel is baked on at very high temperatures. This can cause some slight colour variation. This is normal and does not affect operation. The edges of thin trays cannot be completely enamelled. As a result, these edges can be rough. This does not impair the anti-corrosion protection.

Surfaces in the cooking compartment

The back wall, ceiling and side parts in the cooking compartment are self-cleaning. You can tell this from the rough surface.

The cooking compartment floor is enamelled and has smooth surfaces.

Cleaning enamel surfaces

Clean the smooth enamel surfaces with a dish cloth and hot soapy water or a vinegar solution. Then dry them with a soft cloth.

Soften baked-on food remnants with a damp cloth and soapy water. Use stainless steel wire wool or oven cleaner to remove stubborn dirt.

Caution!

Never use oven cleaner in the cooking compartment when it is still warm. This may damage the enamel. Remove all food remnants from the cooking compartment and the appliance door before you next heat up the appliance.

Leave the cooking compartment open to dry after cleaning it.

Tip: It is best to use the cleaning aid. → "Cleaning function" on page 31

Note: Food residues can cause white deposits to form. These are harmless and do not affect how the appliance works. You can remove these residues using lemon juice if required.

Cleaning self-cleaning surfaces

The self-cleaning surfaces are coated with a porous, matte ceramic layer. This coating absorbs and dispels splashes from baking and roasting while the appliance is in operation.

If the self-cleaning surfaces no longer clean themselves sufficiently and dark stains appear, they can be cleaned using the cleaning function. To do this, refer to the information in the relevant section. → "Cleaning function" on page 31

Caution!

Do not use oven cleaner on self-cleaning surfaces. This will damage the surfaces. If oven cleaner does get onto these surfaces, dab it off immediately using water and a sponge cloth. Do not rub the surface and do not use abrasive cleaning aids.

Keeping the appliance clean

Always keep the appliance clean and remove dirt immediately so that stubborn deposits of dirt do not build up.

Warning – Risk of fire!

Loose food remnants, fat and meat juices may catch fire. Before using the appliance, remove the worst of the food remnants from the cooking compartment, heating elements and accessories.

Tips

- Clean the cooking compartment after each use. This will ensure that dirt cannot be baked on.
- Always remove flecks of limescale, grease, starch and albumin (e.g. egg white) immediately.
- Use the universal pan for baking very moist cakes.
- Use suitable ovenware for roasting, e.g. a roasting dish.

Cleaning function

Your appliance is equipped with EcoClean, the floor cleaning aid and a descaling function. The EcoClean cleaning function is used to clean the self-cleaning surfaces in the cooking compartment. Use the floor cleaning aid for intermediate cleaning of the cooking compartment floor. Dirt is soaked beforehand using the floor cleaning aid. It can then be removed more easily. You can use the descaling function to remove limescale from the evaporator.

EcoClean

The self-cleaning surfaces in the cooking compartment are cleaned with the "EcoClean" operating mode.

The self-cleaning surfaces (back panel, ceiling panel and side panels) are coated with a porous, matt ceramic material. This coating absorbs and breaks down splashes from baking, roasting and grilling while the oven is in operation. If the surfaces no longer clean themselves adequately and dark patches appear, the surfaces can be cleaned by the cleaning function.

Note: The appliance records the number of times it is used. The appliance indicates when it has reached a point in time after which cleaning is recommended. The recommendation is displayed until the cleaning function has finished.

If you do not act on this recommendation, the self-cleaning surfaces may become damaged.

If your appliance is already prematurely very dirty or if you notice dark patches on the back panel, do not wait until your appliance recommends cleaning to do so. This is because the more often the appliance is cleaned, the longer the self-cleaning surfaces will retain their cleaning capability. You can clean your appliance at any time as required using the cleaning function.

Before running the cleaning function

Remove shelves, rails, accessories and ovenware from the cooking compartment.

Cleaning the cooking compartment floor and the inside of the appliance door

Remove the worst dirt from the cooking compartment floor, the inside of the appliance door and the interior lighting. Otherwise, patches will appear that can no longer be removed.

Caution!

Do not use oven cleaner on the self-cleaning surfaces. This will damage the surfaces. If oven cleaner does get onto these surfaces, dab it off immediately using water and a sponge cloth. Do not rub the surface and do not use abrasive cleaning aids.









Warning – Risk of burns!

 The appliance becomes very hot on the outside during the cleaning function. Never touch the appliance door. Allow the appliance to cool down. Keep children at a safe distance.

Starting

Make sure you follow all the preparation instructions before setting the cleaning function.

The duration for the cleaning function is preset to one hour. This duration cannot be changed.

1. Touch the  touch button.
2. Touch the  touch button.
3. Use the  or  button to select "EcoClean .
4. Use the  button to navigate to the next line. The cleaning time with EcoClean is displayed.
5. Use the  button to navigate to the next line.
6. Touch the  touch button. The appliance starts EcoClean. The remaining time appears on the display.

Keep the kitchen ventilated while the cleaning function is running.

As soon as the cleaning aid has run through, a signal sounds and the appliance ends the operation automatically.

Once the cleaning function has finished

Once the cooking compartment has cooled down, wipe down the cooking compartment with a damp cloth if necessary.

Note: During operation and while the cleaning function is active, reddish patches may form on the surfaces. This is not rust, but residue from food. These spots are not harmful and do not impair the cleaning ability of the self-cleaning surfaces.

Floor cleaning aid



The floor cleaning aid makes it easier to clean the cooking compartment floor. Dirt is soaked beforehand by vaporizing the soapy water. It can then be removed more easily.







Warning – Risk of scalding!

Water in a hot cooking compartment may create hot steam. Never pour water into the cooking compartment when the cooking compartment is hot.

Starting

Notes

- The "Floor cleaning aid " cleaning aid can only be started once the cooking compartment is cold (room temperature) and the appliance door is closed.
- Do not open the appliance door while it is running. Doing this will interrupt the "Floor cleaning aid " cleaning aid.

1. Remove any accessories from the cooking compartment.
2. Mix 0.4 litres water (not distilled water) with a drop of washing-up liquid and pour into the middle of the cooking compartment floor.
3. Touch the  touch button.
4. Touch the  touch button.
5. Use the  or  button to select "Floor cleaning aid .
6. Use the  button to navigate to the next line.
7. Touch the  touch button. The appliance starts the floor cleaning aid. The remaining time appears on the display.

End

As soon as the cleaning aid has run through, a signal sounds and the appliance ends the operation automatically.

As soon as you open the appliance door, the interior lighting is switched on so that you can rinse the cooking compartment more easily. The remaining water in the cooking compartment must be removed promptly. Do not leave the remaining water in the cooking compartment for a long time (e.g. overnight). The appliance must not be operated when the cooking compartment is still wet or damp.

Subsequent cleaning

1. Open the appliance door and remove the remaining water with an absorbent sponge cloth.
2. Clean the smooth surfaces in the cooking compartment with a dish cloth or a soft brush. Stubborn residues can be removed using a stainless steel scouring pad.
3. Remove limescale with a cloth soaked in vinegar. Then wipe with clean water and rub dry with a soft cloth (including under the door seal).
4. Use the  touch button to switch off the appliance.
5. Leave the appliance door ajar in the stop position (approx. 30°) for approx. one hour to allow the enamel surfaces in the cooking compartment to dry thoroughly. Alternatively, you can also run the rapid drying function for the cooking compartment.

Running the rapid drying function for the cooking compartment

1. After the cleaning aid has been run through, leave the appliance door ajar in the stop position (approx. 30°).
2. Touch the  touch button.
3. Start CircoTherm hot air at 50 °C.
4. After five minutes, switch off the appliance and close the appliance door.

Removing heavy deposits of dirt

You have several options for removing particularly stubborn deposits of dirt.

- Leave the soapy water to work for some time before starting the cleaning aid.
- Rub soapy water onto the dirt on the smooth surfaces before starting the cleaning aid.
- Repeat the cleaning aid after the cooking compartment has cooled down.

Descaling

To ensure that your appliance continues to operate correctly, it must be descaled regularly.

Descaling comprises a number of different steps. For hygiene reasons, the descaling programme must be run through completely before the appliance is ready for operation again. In total, the descaling programme runs for approx. 70–95 minutes.

- Descale (approx. 55–70 minutes), then empty and refill the water tank
- First rinsing cycle (approx. 9–12 minutes), then empty and refill the water tank
- Second rinsing cycle (approx. 9–12 minutes), then empty and dry the water tank

If descaling is interrupted (e.g. due to a power failure or because the appliance is switched off), you will be prompted to rinse the appliance twice when you switch it back on. The appliance cannot be used until the second rinsing cycle has finished.







The frequency with which the appliance must be descaled depends on the hardness of the water used. When only another five or fewer steam-assisted operations are possible, the appliance reminds you to descale it with a message on the display. The number of remaining operations is displayed after the appliance is switched on. You can therefore prepare for the descaling in good time.



Starting

Caution!

- Risk of damage to the appliance: Only use the liquid descaler recommended by us for the descaling programme. The length of time for which the descaler is left to work is based on this product. Using other descalers may damage the appliance. Descaler order no. 311 680
- Descaling solution: Do not allow any descaling solution or descaler to come into contact with the control panel or other surfaces on the appliance. This may damage the surfaces. If this does happen, remove the descaling solution immediately with water.

If you have used a steam-assisted operation immediately before descaling, you must first switch the appliance off so that the residual water is pumped out of the evaporator system.

1. Mix 400 ml water with 200 ml liquid descaler to make a descaling solution.
2. Touch the  touch button.
3. Remove the water tank and pour the descaling solution into it.
4. Once the descaling solution has been poured into the water tank, push the tank back in again fully.
5. Close the control panel.
6. Touch the  touch button.
7. Use the  or  button to select "Descale ".
8. Use the  button to navigate to the next line. The duration of the descaling process is displayed. It cannot be changed.

9. Use the  button to navigate to the next line.
10. Touch the  touch button.
The appliance will now be descaled. The time counts down in the display. An audible signal sounds once descaling has finished.

First rinse cycle

1. Open the control panel.
2. Remove the water tank, rinse thoroughly, fill with water and reinsert.
3. Close the control panel.
4. Touch the  touch button.
The appliance now rinses itself. Once the rinse cycle has run through to the end, an audible signal sounds.

Second rinse cycle

1. Open the control panel.
2. Remove the water tank, rinse thoroughly, fill with water and reinsert.
3. Close the control panel.
4. Touch the  touch button.
The appliance now rinses itself. Once the rinse cycle has run through to the end, an audible signal sounds.

Subsequent cleaning

1. Open the control panel.
2. Empty and dry the water tank.
3. Switch off the appliance.
Descaling is complete and the appliance is ready for use again.

Rails

With good care and cleaning, your appliance will retain its appearance and remain fully functional for a long time to come. This will tell you how to remove the shelves and clean them.

Detaching and refitting the rails

Warning – Risk of burns!

The rails become very hot. Never touch the hot rails. Always allow the appliance to cool down. Keep children away from the appliance.

Detaching the rails

1. Lift the rail slightly at the front **a** and detach it **b** (figure **1**).
2. Then pull the whole rail towards you and take it out (figure **2**).

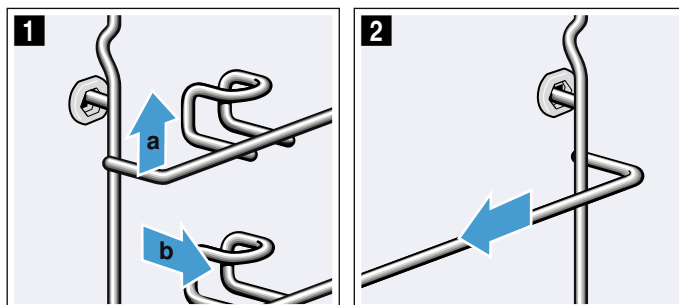

Clean the rails with cleaning agent and a sponge. For stubborn deposits of dirt, use a brush.

Attaching the rails

The rails only fit on the right or the left side. For both rails, ensure that the retaining bracket is at the front.

1. First, insert the rail in the middle of the rear socket **a**, until the rail rests against the cooking compartment wall, and push it back **b** (figure **1**).
2. Then insert the rail into the front socket **c**, until the rail also rests against the cooking compartment wall here, and press it downwards **d** (figure **2**).

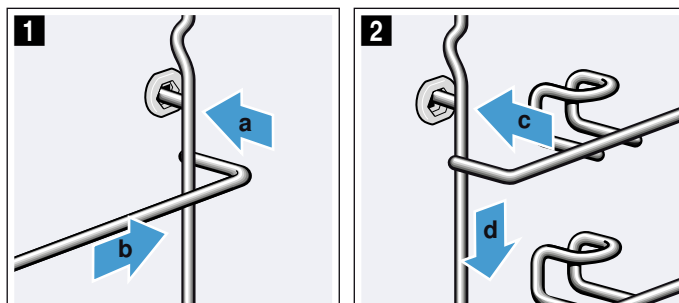

Appliance door

With good care and cleaning, your appliance will retain its appearance and remain fully functional for a long time to come. This will tell you how to clean the appliance door.

Detaching and refitting the appliance door

For cleaning purposes or to remove the door panels, you can detach the appliance door.

The appliance door hinges each have a locking lever. When the locking levers are closed (fig. 1), the appliance door is secured in place. It cannot be detached.

When the locking levers are open in order to detach the appliance door (fig. 2), the hinges are locked. They cannot snap shut.

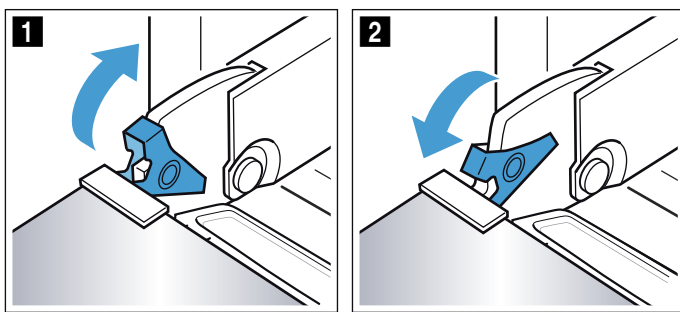

Warning Risk of injury!

- If the hinges are not locked, they can snap shut with great force. Ensure that the locking levers are always fully closed or, when detaching the appliance door, fully open.
- The hinges on the appliance door move when opening and closing the door, and you may be trapped. Keep your hands away from the hinges.

Detaching the appliance door

1. Open the appliance door fully.
2. Open the two locking levers on the left and right (fig. 1).
3. Close the appliance door fully **a**. Take hold of the appliance door with both hands, one on the left and one on the right **b**, and pull it up and out (fig. 2).

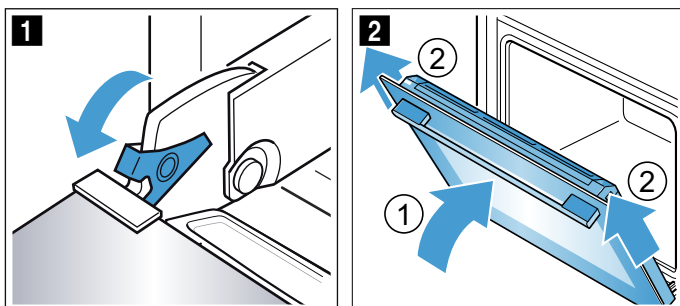

Refitting the appliance door

Follow the instructions in the reverse order to refit the appliance door.

1. Press down on the seal **a** along the drip trough (fig. 1); otherwise, the seal **a** may become detached during cleaning.

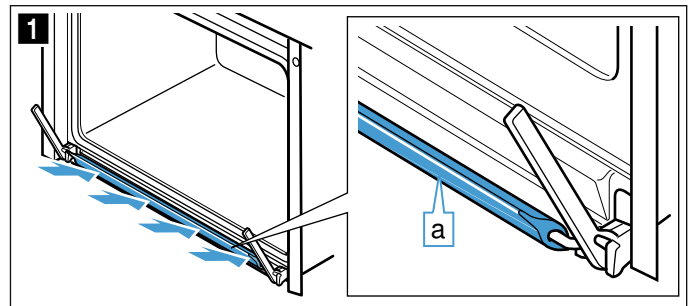

2. When fitting the appliance door, ensure that both hinges are inserted straight into the opening (fig. 2). Slide the appliance door down as far as it will go.
3. Open the appliance door fully. Close the two locking levers (fig. 3).

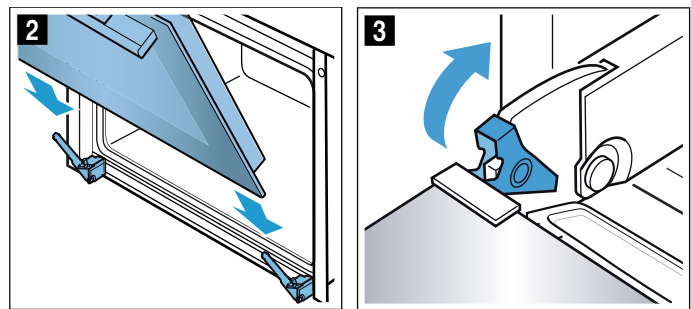

4. Close the cooking compartment door.

Removing and installing the door panels

To facilitate cleaning, you can remove the glass panels from the appliance door.

Locking the appliance door

1. Open the appliance door fully.
2. Open the two locking levers on the left and right (fig. 1).
3. Close the appliance door as far as it goes (fig. 2).

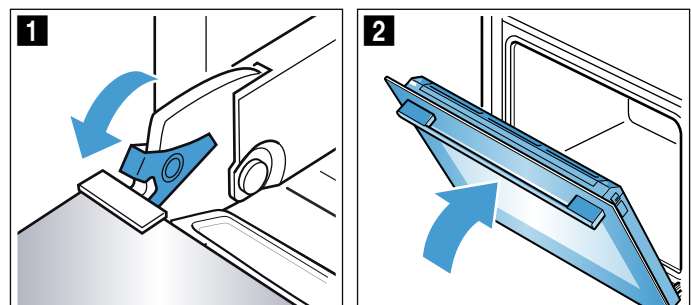

Removing panels

1. Press on the left- and right-hand sides of the cover (fig. **1**).
2. Remove the cover (fig. **2**).

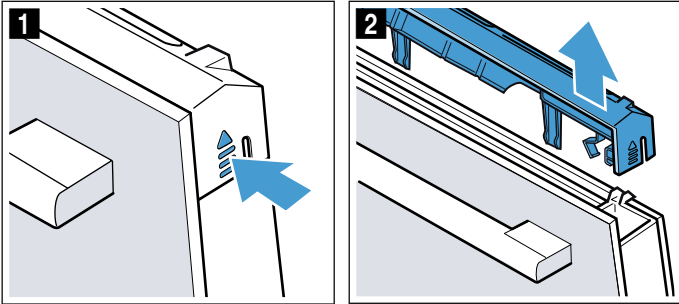

3. Lift out the inner panel (fig. **3**) and set it down carefully on a flat surface.

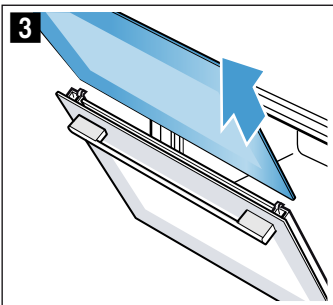

4. Take off the seal on both sides and remove it (fig. **4**).

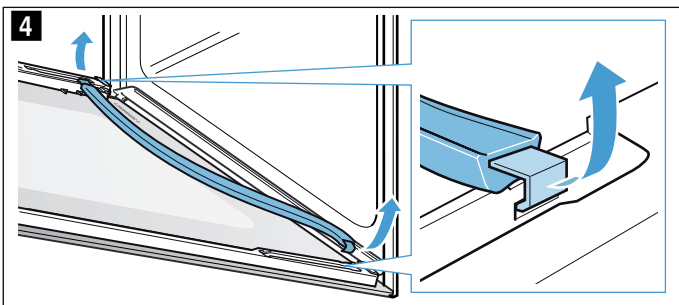

5. Lift out the intermediate glass panel (fig. **5**) and set it down carefully on a flat surface.

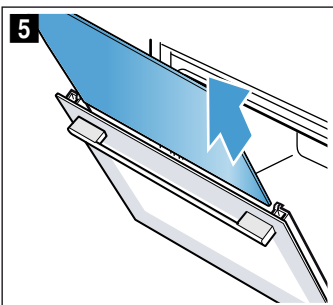

6. If necessary, you can remove the condensate trough for cleaning. To do this, open the appliance door fully (fig. **6**).
7. Tilt the condensate trough up and remove it (fig. **7**).

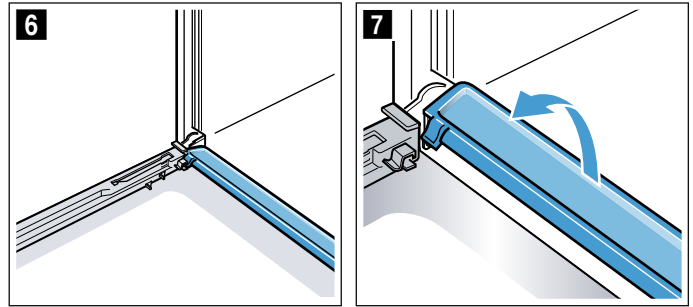

Clean the panels with glass cleaner and a soft cloth. Wipe the condensate trough with a cloth and some hot soapy water.

Warning Risk of injury!

- Scratched glass in the appliance door may develop into a crack. Do not use a glass scraper, sharp or abrasive cleaning aids or detergents.
- The hinges on the appliance door move when opening and closing the door, and you may be trapped. Keep your hands away from the hinges.

Fitting panels

1. Open the appliance door fully and refit the condensate trough. To do this, insert the trough from above and rotate it at the bottom (fig. **1**).

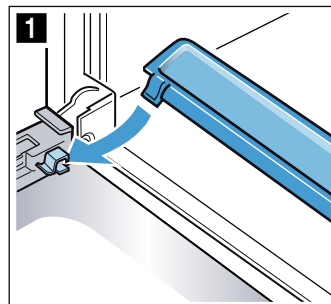

2. Slide the intermediate glass panel back in and make sure that it is sitting correctly at the bottom in the retainer (fig. **2**).

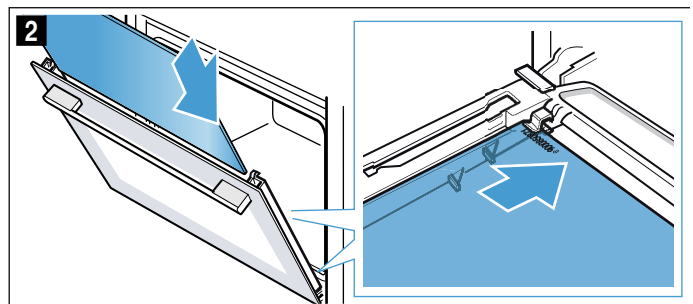

3. Press down on the top of the intermediate glass panel (fig. 3).

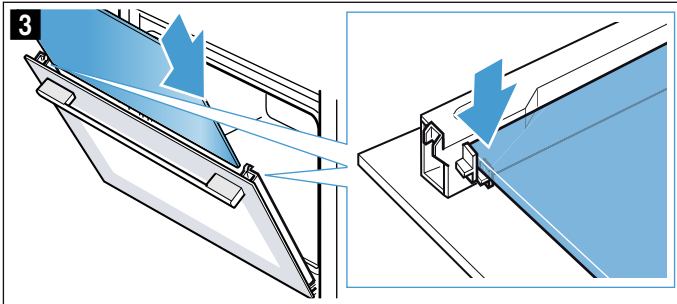

4. Refit the seal on the left and right (fig. 4)

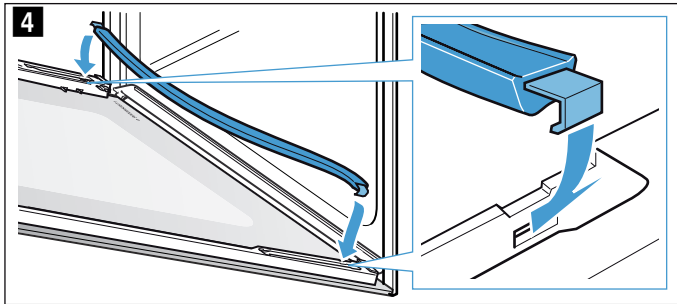

5. Push in the inner glass panel.
Before sliding the panel in, make sure that the glossy side of the panel is on the outside and the cut-outs on the left and right are at the top.
The panel must be sitting correctly at the bottom in the retainer (fig. 5).

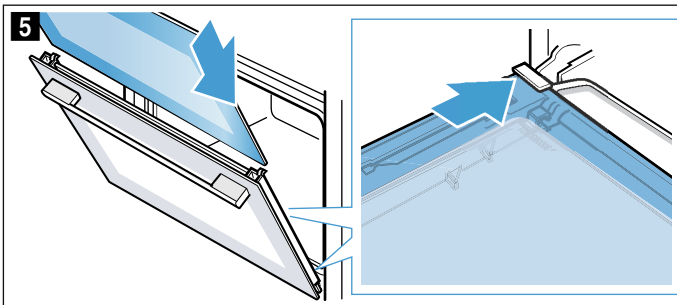

6. Push the inner panel in at the top (fig. 6).

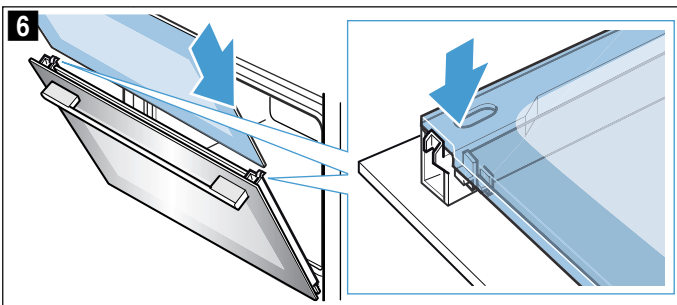

7. Put the cover back in place and press on it until you hear it click into place (fig. 7).
8. Open the appliance door again fully.
9. Close the two locking levers on the left and right (fig. 8)

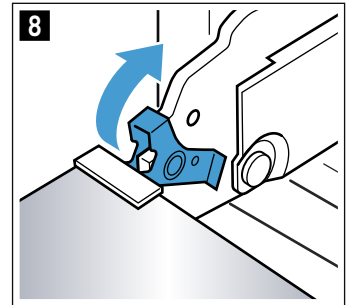
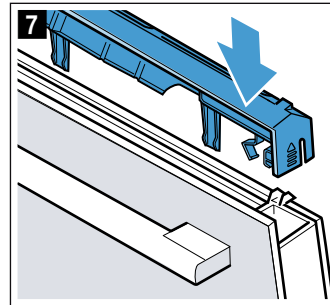

10. Close the appliance door.

Caution!

Do not use the cooking compartment again until the panels have been correctly fitted.

Trouble shooting

If a fault occurs, there is often a simple explanation. Before calling the after-sales service, please refer to the fault table and attempt to correct the fault yourself.

Tip: If a meal does not turn out exactly as you wanted, refer to the "Tested for you in our cooking studio" section. Here, you will find plenty of cooking tips and notes.

Warning – Risk of injury!

Incorrect repairs are dangerous. Do not attempt to repair the appliance yourself. Repairs must only be carried out by one of our trained after-sales engineers. If the appliance is defective, call the after-sales service.

Warning – Risk of electric shock!







Incorrect repairs are dangerous. Repairs may only be carried out and damaged power cables replaced by one of our trained after-sales technicians. If the appliance is defective, unplug the appliance from the mains or switch off the circuit breaker in the fuse box. Contact the after-sales service.

Fault table

Warning – Risk of electric shock!

- Work on the appliance electronics may only be performed by a specialist.
- Always disconnect the appliance from the power supply when work is carried out on the electronics. Switch off the circuit breaker or remove the fuse from your household fuse box.

Fault	Possible cause	Notes/remedy
The appliance does not work	The plug is not plugged into the mains	Connect the appliance to the power supply
	Power cut	Check whether other kitchen appliances are working
	The circuit breaker is faulty	Check in the fuse box to make sure that the fuse for the appliance is OK
Operations with steam or descaling do not start or do not continue	Water tank empty	Refill water tank
	The panel is open	Close the panel
	Descaling locks operations with steam	Carry out descaling
	Faulty sensor	Call the after-sales service
After switching on an operating mode, a message is shown on the display which indicates that the temperature is too high	The appliance has not cooled down sufficiently	Allow the appliance to cool down and switch the operating mode on again
The appliance prompts you to rinse	The power supply was interrupted or the appliance was switched off during the descaling process	Once the appliance is switched on again, rinse it twice
The appliance prompts you to descale without the counter appearing beforehand	The set water hardness range is too low	Carry out descaling Check the set water hardness range and adjust it, if necessary
Buttons flash	Normal occurrence caused by condensation behind the control panel	As soon as the condensation has evaporated, the buttons no longer flash
Cooked dishes turn out too moist or too dry when cooking with steam-assisted applications	The wrong steam intensity was selected	Select a higher or lower steam intensity
The "Fill water tank" message appears even though the water tank is full	The panel is open	Close the panel
	The water tank is not clicked into place	Click the water tank into place → "Steam" on page 17
	Faulty sensor	Call the after-sales service
	The water tank has fallen off. Due to the impact, components inside the water tank have come loose, and the tank is leaking.	Order a new water tank
The panel for removing the tank does not open	The plug is not plugged into the mains	Connect the appliance to the power supply
	Power cut	Check whether other kitchen appliances are working
	The circuit breaker is faulty	Check in the fuse box to make sure that the fuse for the appliance is OK
	Faulty sensor for the  touch button	Call the after-sales service If required, empty the water tank: Open the appliance door, take hold of the lower part of the panel on the left and right with your fingers and pull out the panel

Steam escapes from the ventilation slots during cooking	Normal procedure	Not possible
When you cook with steam, a lot of steam is produced	The appliance is being automatically calibrated	Normal procedure
When cooking with steam, a lot of steam is produced repeatedly	The appliance is unable to calibrate itself automatically if cooking times are too short	Reset the appliance to the factory settings and repeat the calibration process
The appliance cannot be switched on; the  symbol is shown on the display	The automatic childproof lock is activated	Press and hold the  touch button until the  symbol goes out
The appliance cannot be operated when it is switched on; the  symbol is shown on the display	The childproof lock is activated	Press and hold the  touch button until the  symbol goes out
The appliance does not heat up;  is shown on the display	Demo mode is activated in the basic settings	Disconnect the appliance from the mains for approx. 10 seconds (switch off the circuit breaker in the fuse box) and then deactivate demo mode in the basic settings within 3 minutes → "Basic settings" on page 23
There is a "pop" noise during cooking	Cold/warm effect with frozen food, caused by the steam	Not possible
"D" or "E" appears on the display, e.g. D0111 or E0111	Technical problem	Switch the appliance off and on again If the message appears again, call the after-sales service. Quote the exact error message
Home Connect does not work correctly.		Go to www.home-connect.com

Maximum operating time exceeded

Your appliance ends the operation automatically when no cooking time is set and the setting has not been changed for a long time.

The actual cooking time until the operation is stopped automatically varies according to the selected settings.

The appliance display indicates that the operation will end automatically. Afterwards, the operation is stopped.

To use the appliance again, switch it off beforehand. Then switch the appliance on again and set the required operation.

Cooking compartment bulbs

To light the interior of your cooking compartment, your appliance has one or more long-life LED bulbs.

However, if ever an LED bulb or the bulb's glass cover is defective, call the after-sales service. The lamp cover must not be removed.

Customer service

Our after-sales service is there for you if your appliance needs to be repaired. We will always find an appropriate solution, also in order to avoid after-sales personnel having to make unnecessary visits.

E number and FD number

When calling us, please give the full product number (E no.) and the production number (FD no.) so that we can provide you with the correct advice. The rating plate bearing these numbers can be found on the right-hand side when you open the fascia panel. Touch the  touch button to do this. → "Steam" on page 17

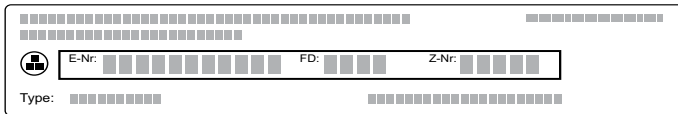

To save time, you can make a note of the number of your appliance and the telephone number of the after-sales service in the space below, should it be required.

E no.

FD no.

After-sales service 

Please note that there will be a fee for a visit by a service technician in the event of a malfunction, even during the warranty period.

Please find the contact data of all countries in the enclosed customer service list.

To book an engineer visit and product advice

GB 0344 892 8989

Calls charged at local or mobile rate.

IE 01450 2655

0.03 € per minute at peak. Off peak 0.0088 € per minute.

Rely on the professionalism of the manufacturer. You can therefore be sure that the repair is carried out by trained service technicians who carry original spare parts for your appliances.

Tested for you in our cooking studio

Here, you can find a selection of dishes and the ideal settings for them. We will show you which type of heating and temperature are best suited to your dish. You will get information on suitable cooking accessories and the height at which they should be placed in the oven. You will also get tips about cookware and preparation methods.

Note: A lot of steam can build up in the cooking compartment when cooking food. Your appliance is very energy-efficient and radiates very little heat to its surroundings during operation. Due to the high difference in temperature between the appliance interior and the external parts of the appliance, condensation may build up on the door, control panel or adjacent kitchen cabinet panels. This is a normal physical phenomenon. Condensation can be reduced by preheating the oven or opening the door carefully.

When steaming or during operation with steam assistance, it is desirable that there is a significant build-up of steam in the cooking compartment. Wipe the cooking compartment clean after cooking, once it has cooled off.

Silicone moulds

For the best cooking results, we recommend dark-coloured metal baking tins/dishes.

Nevertheless, if you wish to use silicone moulds, follow the manufacturer's instructions and recipes. Silicone moulds are often smaller than normal baking tins. Quantity and recipe specifications may vary.

Silicone moulds are unsuitable for steam-assisted cooking and steaming.

Baking

Here, you can find recommended settings for many dishes.

Also refer to the notes in the section on allowing dough to rise.

Only use original accessories supplied with your appliance. These have been tailored to the cooking compartment and the operating modes of your appliance.

Steam- assisted baking

Certain types of baked item (e.g. yeast-risen pastries) get a more crispy crust and a more glossy surface if baked with the steam assist mode. The baked item does not dry out as much.

Steam-assisted baking is only possible on one level.

Some food turns out better if it is baked in several stages. These dishes are indicated in the table.

Shelf positions

Use the indicated shelf positions.

Baking on one level

When baking on one level, use the following shelf position:

- Level 1

Baking on two levels

Use CircoTherm. Baked items that are placed into the oven on trays or in baking tins/dishes at the same time will not necessarily be ready at the same time.

- Universal pan: Level 3
Baking tray: Level 1
- Baking tins/dishes on the wire rack
First wire rack: Level 3
Second wire rack: Level 1

By preparing several dishes at the same time, you can make energy savings of up to 45 per cent. Position baking tins/dishes next to one another or offset and vertically stacked in the cooking compartment.

Accessories

Ensure that you always use suitable accessories and that they are placed in the oven the right way around.

Wire rack

Insert the wire rack with the open side facing the appliance door and the curved lip pointing downwards. Always place ovenware, tins and dishes on the wire rack.

Universal pan or baking tray

Slide the universal pan or the baking tray in carefully as far as the limit stop with the bevelled edge facing the appliance door.

When baking moist cakes or pastries with many toppings, use the universal pan so that any excess liquid does not overflow and make the cooking compartment dirty.

Baking tins

Dark- coloured metal baking tins are most suitable.

Tinplate baking tins, ceramic dishes and glass dishes extend baking time and mean that the baked item will not brown evenly.

The baking tins must be resistant to heat and steam for use in steam-assisted baking.

Greaseproof paper

Only use greaseproof paper that is suitable for the selected temperature. Always cut greaseproof paper to size.

Recommended setting values

The table lists the optimal heating type for various baked items. The temperature and baking time depend on the amount and consistency of the dough/mixture. For this reason, the table specifies setting ranges. Try using the lower values to start with. A lower temperature will result in more even browning. You can use a higher setting next time if necessary.

Note: Baking times cannot be reduced by using higher temperatures. Cakes or small baked items would only be cooked on the outside, and would not be fully baked in the middle.





The setting values apply to food that is placed into a cold cooking compartment; by doing this, you can make energy savings of up to 20 per cent. If you preheat the oven, you can reduce the indicated baking times by several minutes.

Preheating is necessary for selected food, and this is indicated in the table. Do not place your food or accessories into the cooking compartment until it has finished preheating.

If you wish to follow one of your own recipes when baking, you should use the setting values listed for similar baked items in the table as reference. Additional information can be found in the baking tips listed after the settings table.







Remove unused accessories from the cooking compartment. This will ensure that you achieve the best possible cooking results and energy savings of up to 20 per cent.









































Types of heating used:





-  CircoTherm
-  Top/bottom heating
-  Circotherm intensive
-  Bread baking
-  Steam cooking

The levels of steam intensity are indicated as numbers in the table:

- 1 = Low
- 2 = Medium
- 3 = High

Dish	Accessories/cookware	Shelf position	Type of heating	Temperature in °C	Steam intensity	Cooking time in mins.
One level baking						
Victoria sponge cake	2x Ø20 cm tins	1		160-170*	-	20-30
Victoria sponge cake	2x Ø20 cm tins	1		150-160	1	25-35
Light fruit cake	high Ø20cm tin	1		140-160	-	70-90
Light fruit cake	high Ø20 cm tin	1		140-150	1	90-100
Rich Fruit Cake	high Ø23cm tin	1		130-150	-	150-180
Fruit crumble	flat glass dish	2		150-170*	-	30-45
Sponge Cake (fatless), 3 eggs	springform cake tin, Ø26 cm	1		160-170*	-	25-35
* Preheat						

Dish	Accessories/cookware	Shelf position	Type of heating	Temperature in °C	Steam intensity	Cooking time in mins.
Sponge Cake (fatless), 3 eggs	springform cake tin, Ø26 cm	1		150-160	1	10
					-	25-35
Sponge flan, 6 eggs	springform cake tin, Ø28 cm	1		150-170*	-	30-50
Sponge flan, 6 eggs	springform cake tin, Ø28 cm	1		150-160	1	10
					-	30-35
Swiss Roll	swiss roll tin	2		180-190*	-	10-18
Swiss Roll	swiss roll tin	2		180-190*	1	10-15
Fruit Pie	plate Ø20cm or pie tin	1		180-190	-	45-50
Fruit Pie	plate Ø20cm or pie tin	1		170-190	-	55-70
Quiche	quiche tin (dark coated)	1		190-210	-	30-45
(White) Bread	loaf tin (1x 900 g or 2x 450 g)	1		190-210*	-	20-30
(White) Bread	loaf tin (1x 900 g or 2x 450 g)	1		210-220	3	10-15
				180-190	-	25-35
Scones	baking tray	1		180-200*	-	10-14
Scones	baking tray	1		200-210*	-	10-15
Biscuits	baking tray	2		140-160*	-	10-25
Biscuits	baking tray	1		150-170	-	10-25
Small cakes	12-cup-tin	1		140-160*	-	20-35
Small cakes	12-cup-tin	1		150-170	-	20-30
Puff pastry slices	baking tray	2		170-190*	-	20-45
Puff pastry slices	baking tray	1		210-220*	1	15-25
Jam tarts	12-cup-tin	2		160-180*	-	15-30
Jam tarts	12-cup-tin	1		180-200	-	15-25
Meringue	baking tray	2		90-100*	-	100-130
Pavlova	baking tray	2		90-100*	-	120-180
Soufflé	1,2 L-soufflé dish	1		160-170*	-	40-50
Soufflé	1,2 L-soufflé dish	1		170-180	2	35-45
Soufflé	individual moulds	1		100	-	40-45
Choux pastry	baking tray	1		190-210*	-	30-40
Choux pastry	baking tray	1		200-220*	1	25-35
Meat Pie	rectangular pie tin	1		180-190	-	40-50
Meat Pie	rectangular pie tin	1		170-180	2	40-50
Yorkshire Pudding	12-cup-tin	1		200-220*	-	15-25
Jacket potatoes	baking tray	2		150-170	-	75-90
Jacket potatoes	baking tray	2		180-190	1	40-50
Pizza, homemade	baking tray	1		200-220	-	20-30
Pizza, homemade	baking tray	1		220-230	-	25-30
Pizza, homemade, thin base	pizza tray	1		220-240	-	25-35
Pizza, homemade, thin base	pizza tray	1		210-230	-	20-30
Multishelf baking						
Victoria sponge cake, 2 levels	4x Ø20 cm tins	3+1		160-170*	-	20-35
Scones, 2 levels	2 baking trays	3+1		180-200*	-	12-16
Biscuits, 2 levels	2 baking trays	3+1		140-160*	-	15-30
Small cakes, 2 levels	2x 12-cup-tins	3+1		140-160*	-	22-32
Puff pastry slices, 2 levels	2 baking trays	3+1		170-190*	-	20-45
* Preheat						

Dish	Accessories/cookware	Shelf position	Type of heating	Temperature in °C	Steam intensity	Cooking time in mins.
Jam tarts, 2 levels	2x 12-cup-tins	3+1		160-180*	-	20-35
Meringues, 2 levels	2 baking trays	3+1		90-100*	-	100-130
Jacket potatoes, 2 levels	universal pan + baking tray	3+1		150-170*	-	75-90
Pizza, homemade, 2 levels	universal pan + baking tray	3+1		180-200	-	35-45

* Preheat

Tips on baking

You want to find out whether the cake is completely cooked in the middle.	Push a cocktail stick into the highest point on the cake. If the cocktail stick comes out clean with no dough residue, the cake is ready.
The cake collapses.	Next time, use less liquid. Alternatively, set the temperature to be 10 °C lower and extend the baking time. Adhere to the specified ingredients and preparation instructions in the recipe.
The cake has risen in the middle but is lower around the edge.	Only grease the base of the springform cake tin. After baking, loosen the cake carefully with a knife.
The fruit juice overflows.	Next time, use the universal pan.
Small baked items stick to one another during baking.	There should be a gap of approx. 2 cm around each item. This gives enough space for the baked items to expand well and brown on all sides.
The cake is too dry.	Set the temperature 10 °C higher and shorten the baking time.
The cake is generally too light in colour.	If the shelf position and the cookware are correct, then you should increase the temperature if necessary or extend the baking time.
The cake is too light on top, and too dark underneath.	Bake the cake one level higher in the oven the next time.
The cake is too dark on top, and too light underneath.	Bake the cake one level lower in the oven the next time. Select a lower temperature and extend the baking time.
Cakes baked in a tray or tin are too brown at the back.	Place the baking tray in the middle of the accessories, not directly against the back wall.
The whole cake is too dark.	Select a lower temperature next time and extend the baking time if necessary.
The cake is unevenly browned.	Select a slightly lower temperature. Protruding greaseproof paper can affect the air circulation. Always cut greaseproof paper to size. Ensure that the baking tin does not stand directly in front of the openings in the cooking compartment back wall. When baking small items, you should use similar sizes and thicknesses wherever possible.
You were baking on several levels. The items on the top baking tray are darker than those on the lower baking tray.	Always use Circotherm when baking on several levels. Baked items that are placed into the oven on trays or in baking tins/dishes at the same time will not necessarily be ready at the same time.
The cake looks good, but is not cooked properly in the middle.	Use a lower temperature and bake slightly longer; if necessary, add slightly less liquid. For cakes with a moist topping, bake the base first. Sprinkle it with almonds or breadcrumbs and then place the topping on top.
The cake cannot be turned out of the dish when it is turned upside down.	Allow the cake to cool down for 5 to 10 minutes after baking. If it still sticks, carefully loosen the cake around the edges again using a knife. Turn the cake tin upside down again and cover it several times with a cold, wet cloth. Next time, grease the baking tin/dish and sprinkle with breadcrumbs.

Roasting and braising

Here, you can find information on roasting and braising poultry and meat. You can find the ideal settings for many dishes in the settings tables.

Poultry

For duck or goose, pierce the skin on the underside of the wings. This allows the fat to run out.

If using duck breast, score the skin. Do not turn duck breasts.

When you turn poultry, ensure that the breast side or the skin side is underneath at first.

Poultry will turn out particularly crispy and brown if you baste it towards the end of the roasting time with butter, salted water or orange juice.

Meat

Baste lean meat with fat as required or cover it with strips of bacon.

Score the rind crosswise. If you turn the joint when cooking, ensure that the rind is underneath at first.

When the joint is ready, turn off the oven and allow it to rest for another 10 minutes in the cooking compartment. This allows the meat juices to be better distributed. Wrap the joint in aluminium foil if necessary. The recommended resting time is not included in the cooking time indicated.

Roasting on the wire rack

On the wire rack, poultry and meat will become very crispy on all sides. Roasting on the wire rack is well suited for larger poultry or for multiple pieces at the same time.

Depending on the size and type of the meat, add up to ½ litres of water to the universal pan. Any dripping fat and meat juices will be caught. You can prepare a sauce using these meat juices. In addition, less smoke is generated, and the cooking compartment stays cleaner.

Slide the universal pan into the oven at the indicated shelf position with the wire rack attached. Ensure that the wire rack is correctly positioned on the universal pan. → *"Accessories" on page 12*

Roasting and braising in cookware

It is more convenient to roast and braise meat in cookware. You can take the joint out of the cooking compartment more easily in the cookware, and prepare the sauce in the cookware itself.

Only use cookware which is suitable for use in an oven. Check whether the cookware fits in the cooking compartment.

Glass cookware is most suitable. Place hot glass cookware onto a dry mat after cooking. If the surface is damp or cold, the glass may crack.

Add in a little liquid for roasting if the meat is lean. A covering of approx. ½ cm depth should be applied to the base of any glass cookware.

The amount of liquid is dependent on the type of meat, the cookware material and also on whether or not a lid is used. If preparing meat in an enamelled or dark metal roasting dish, it will need a little more liquid than if cooked in glass cookware.

The steam evaporates in the cookware when roasting. Carefully pour in more liquid if required.

Shiny roasting dishes made from stainless steel or aluminium reflect heat like a mirror and are therefore not particularly suitable. The meat cooks more slowly and will not brown so much. Use a higher temperature and/or a longer cooking time.

Observe the manufacturer's instructions for your roasting cookware.

Roasting in uncovered cookware

It is best to use a deep roasting tin/dish for roasting poultry and meat. Place the tin/dish onto the wire rack. If you do not have any suitable cookware, use the universal pan.

Braising in covered cookware

When preparing food with covered cookware, the cooking compartment remains considerably cleaner. Ensure that the lid fits well and closes properly. Place the cookware onto the wire rack.

The distance between the meat and the lid must be at least 3 cm. The meat may rise.

Very hot steam may escape when opening the lid after cooking. Lift the lid at the rear, so that the hot steam can escape away from you.

If necessary, braise the meat first by searing it. Add water, wine, vinegar or a similar liquid to the braising liquid. A covering at least 2 cm deep should be applied to the base of the cookware.

The steam evaporates in the cookware when roasting. Carefully pour in more liquid if required.

Steam- assisted roasting and braising

Certain dishes become crispier if cooked using steam, and do not dry out as much.

Use uncovered cookware. Cookware must be heat- and steam-resistant.

The joints do not have to be turned.

Use steam-assisted cooking if it is indicated in the settings table. Some dishes turn out best if they are cooked in several stages. These are indicated in the table.

Steaming

By contrast to the steam assistance function, the steaming function cooks the meat particularly gently, but it does not become crispy on the outside. It remains very succulent. As an alternative, you can also fry pieces of meat quickly before steaming; the cooking time will be reduced.

Larger pieces require a longer heating-up time and a longer cooking time. If you are using several pieces which are the same weight, the heating-up time is increased, and not the cooking time.

Pieces of meat do not need to be turned.

Use the perforated steam container (size XL) and slide the universal pan in underneath. You can also use a glass tray and place this onto the wire rack.

Recommended setting values

In the table, you can find the ideal heating type for poultry and meat. Temperature and cooking time depend on the quantity, composition and temperature of the food. Different settings ranges are indicated for this reason. Try using the lower values at first. You can increase the temperature next time if necessary.

The setting values are based on the assumption that unstuffed, chilled, ready-to-roast poultry and meat are placed into a cold cooking compartment. By doing so, you can make energy savings of up to 20 per cent. If you preheat the oven, the indicated cooking times will be reduced by several minutes.

In the table, you can find specifications for poultry and meat with default values for the weight. If you wish to prepare heavier poultry or meat, use the lower temperature in every case. If roasting several joints, use the weight of the heaviest piece as a basis for determining the cooking time. The individual pieces should be approximately equal in size.

A general rule: the larger the poultry or piece of meat is, the lower the cooking temperature and the longer the cooking time.

Turn the poultry and meat after approx. ½ to ⅔ of the indicated time.

Remove unused accessories from the cooking compartment. This will achieve the best possible cooking results and energy savings of up to 20 per cent.

Cooking time calculation (e. g. 20+35):
Please calculate the cooking time with 20 minutes per

500 g meat + 35 minutes additional time. For 1,5 kg the calculated cooking time would be 95 minutes.





















Cooking time range (e. g. 10-15):
The food is done within the stated minutes.

Type of heating used:

-  CircoTherm

The levels of steam intensity are indicated as numbers in the table:

- 1 = Low
- 2 = Medium
- 3 = High















Dish	Accessories/cookware	Shelf position	Type of heating	Temperature in °C	Steam intensity	Time in min.
Beef						
Slow roasting joint	wire rack	1		140-150	-	35+40
Slow roasting joint, 1.5 kg	wire rack	1		130-140	1	70-80
					-	40-50
Top side / Top rump	wire rack	1		160-170	-	30+25
Top side / Top rump	wire rack	1		170-180	1	100-120
Lamb						
Leg (bone-in)	wire rack	1		160-170	-	25+25
Leg (bone-in), 1.5 kg	wire rack	1		180-190	1	80-90
Shoulder (bone-in)	wire rack	1		160-170	-	25+20
Shoulder (boned and rolled)	wire rack	1		170-180	-	25+25
Rack of lamb***	wire rack	1		180-190*	-	15+25
Rack of lamb, each 700 g	wire rack	1		200	-	20
				170-180	1	25-30
Pork						
Roasting joint	wire rack	1		180-190	-	30+35
Roasting joint, 1.5 kg	wire rack	1		120	3	30
				190-200	-	30
				160-170	1	80-100
Loin joint	wire rack	1		180-190	-	35+35
Loin joint, 1 kg	wire rack	1		180-190	-	25-30
				170-180	1	70-80
Belly	wire rack	1		170-180	-	30+25
Gammon joint	wire rack	1		160-170	-	30+30
Gammon joint, 1.5 kg	wire rack	1		170-180	2	100-120
Poultry						
Chicken, whole	wire rack	1		170-180	-	25+15
Chicken, whole, 1.5 kg	wire rack	1		180-190	2	65-75
Chicken, portion, 200-250 g each**	wire rack	1		190-200	-	35-45
Chicken, portion, 200-250 g each**	wire rack	2		200-210	2	35-45
Duck	wire rack	1		180-190	-	25+20

* Preheat

** skin side down

*** without fat layer (best and neck), do not turn

**** bone side down, do not turn

Dish	Accessories/cookware	Shelf position	Type of heating	Temperature in °C	Steam intensity	Time in min.
Duck, 2-3 kg	wire rack	1		160-170	2	70-90
				170-180	-	30-40
Turkey, crown****	wire rack	1		150-160	-	20+15
Turkey, crown, 3 kg	cookware, uncovered	1		140-150	2	100-140
Turkey, thighs	wire rack	1		170-180	-	25+30
Turkey, whole, 4-8 kg	wire rack	1		150-160	-	12+12
Turkey, whole, 7 kg	universal pan	1		140-150	2	120-150
				170-180	-	30-40
Meat dishes						
Meat loaf	cookware, uncovered	1		170-180	-	20+35
Meat loaf, 1 kg	cookware, uncovered	1		190-200	1	70-80
Casserole						
Diced meat (beef, pork, lamb), 500 g meat	cookware, covered	1		140*	-	100-120
Braising steak	cookware, covered	1		140	-	65+60
Chicken pieces (boned), 500 g meat	cookware, covered	1		140*	-	90-100
Complete meal						
With beef	wire rack + wire rack	3+1		160, then 200 (Yorkshire Pudding)	-	calculation for meat (see table above) + 15-25 for Yorkshire Pudding
With chicken	wire rack + wire rack	3+1		180	-	calculation for chicken (see table above)
With chicken	wire rack + wire rack	3+1		180	low (steam 0 when Yorkshire Pudding is inserted)	65-75
* Preheat						
** skin side down						
*** without fat layer (best and neck), do not turn						
**** bone side down, do not turn						

Tips on roasting and braising

The cooking compartment becomes very dirty.	Prepare your food in an enclosed roasting dish with higher temperature or use the grill tray. You will achieve the best roasting results if you use the grill tray. The grill tray can be bought later as a special accessory.
The roast is too dark and the crackling is burned in places, and/or the roast is too dry.	Check the shelf position and temperature. Select a lower temperature the next time and reduce the roasting time if necessary.
The crackling is too thin.	Increase the temperature or switch on the grill briefly at the end of the roasting time.
The roast looks good but the juices are burnt.	Next time, use a smaller roasting dish and add more liquid if necessary.
The roast looks good but the juices are too clear and watery.	Next time, use a larger roasting dish and add less liquid if necessary.
The meat gets burned during braising.	The roasting dish and lid must fit together well and close properly. Reduce the temperature and add more liquid when braising if necessary.

Grilling

Here, you can find information on grilling poultry, meat and fish, as well as toast. You can find the ideal settings for certain dishes in the settings tables.

Grilling with circo-roasting

Circo-roasting is very well suited to the preparation of whole poultry and fish, in addition to meat, e.g. roast pork with crackling.

Poultry

For duck or goose, pierce the skin on the underside of the wings. This allows the fat to run out.

If using duck breast, score the skin. Do not turn duck breasts.

When you turn poultry, ensure that the breast side or the skin side is underneath at first.

Poultry will turn out particularly crispy and brown if you baste it towards the end of the roasting time with butter, salted water or orange juice.

Meat

Baste lean meat with fat as required or cover it with strips of bacon.

Score the rind crosswise. If you turn the joint when cooking, ensure that the rind is underneath at first.

When the joint is ready, turn off the oven and allow it to rest for another 10 minutes in the cooking compartment. This allows the meat juices to be better distributed. Wrap the joint in aluminium foil if necessary. The recommended resting time is not included in the cooking time indicated.

Fish

Fish cooked whole does not have to be turned. Place the whole fish into the cooking compartment in swimming position with the dorsal fin facing upwards. Placing half a potato or a small oven-proof container in the stomach cavity of the fish will provide stability.

You can tell when the fish is cooked because the dorsal fin can be removed easily.

Roasting on the wire rack

On the wire rack, poultry and meat will become very crispy on all sides. Roasting on the wire rack is well suited for larger poultry or for multiple pieces at the same time.

Depending on the size and type of the meat, add up to ½ litres of water to the universal pan. Any dripping fat and meat juices will be caught. You can prepare a sauce using these meat juices. In addition, less smoke is generated, and the cooking compartment stays cleaner.

Slide the universal pan into the oven at the indicated shelf position with the wire rack attached. Ensure that the wire rack is correctly positioned on the universal pan. → "Accessories" on page 12

Roasting in cookware

It is more convenient to roast and braise meat in cookware. You can take the joint out of the cooking compartment more easily in the cookware, and prepare the sauce in the cookware itself.

Only use cookware which is suitable for use in an oven. Check whether the cookware fits in the cooking compartment.

Glass cookware is most suitable. Place hot glass cookware onto a dry mat after cooking. If the surface is damp or cold, the glass may crack.

Add in a little liquid if the meat is lean. A covering of approx. ½ cm depth should be applied to the base of any glass cookware.

The quantity of liquid is dependent on the type of meat, the cookware material and also on whether or not a lid is used. If preparing poultry, meat or fish in an enamelled or dark metal roasting dish, it will need a little more liquid than if cooked in glass cookware.

The steam evaporates in the cookware when roasting. Carefully pour in more liquid if required.

Shiny roasting dishes made from stainless steel or aluminium reflect heat like a mirror and are therefore not particularly suitable. The meat cooks more slowly and will not brown so much. Use a higher temperature and/or a longer cooking time.

Observe the manufacturer's instructions for your roasting cookware.

Uncovered cookware

Use a deep roasting tin/dish for roasting meat. Place the tin/dish onto the wire rack. If you do not have any suitable cookware, use the universal pan.

Covered cookware

When cooking with covered cookware, the cooking compartment remains considerably cleaner. Ensure that the lid fits well and closes properly. Place the cookware onto the wire rack.

The distance between the meat and the lid must be at least 3 cm. The meat may rise.

Very hot steam may escape when opening the lid after cooking. Lift the lid at the rear, so that the hot steam can escape away from you.

If necessary, braise the meat first by searing it. Add water, wine, vinegar or a similar liquid to the braising liquid. A covering approx. 1-2 cm deep should be applied to the base of the cookware.

The steam evaporates in the cookware when roasting. Carefully pour in more liquid if required.

Meat can also become crispy in a covered roasting dish. To do so, use a roasting dish with a glass lid and set a higher temperature.

Steam-assisted roasting

Certain foodstuffs will become crispier during steam-assisted cooking. Their surface becomes glossier and they dry out less.

Use uncovered cookware. Cookware must be heat- and steam-resistant.

Use steam-assisted cooking if it is indicated in the settings table. Some dishes turn out best if they are cooked in several stages. These are indicated in the table.

Grilling flat pieces

Flat pieces of poultry, meat and fish, such as steaks, drumsticks and burgers, can be prepared well using the "Grill" heating type. Excellent results are also achieved when grilling toast.

Grilling

Keep the appliance door closed when using the grill. Never grill with the appliance door open.

Place the food to be grilled on the wire rack. In addition, slide the universal pan in at least one shelf position lower, with the slanted edge facing the appliance door. Any dripping fat will be caught.

When grilling, try wherever possible to use pieces of food which are of a similar thickness and weight. This will allow them to brown evenly and remain succulent and juicy. Place the food to be grilled directly onto the wire rack.

Use tongs to turn the pieces of food you are grilling. If you pierce the meat with a fork, the juices will run out and it will become dry.

Do not add salt until after the meat has been grilled. Salt draws water from the meat.

Notes

- The grill element switches itself continuously on and off; this is normal. The set temperature determines how frequently this occurs.
- Smoke may be produced when grilling.

Recommended setting values

In the table, you can find the ideal heating type for your poultry, meat and fish, in addition to toast. Temperature and cooking time depend on the quantity, composition and temperature of the food. Settings ranges are indicated for this reason. Try using the lower values at

first. You can use a higher setting next time if necessary.

The setting values are based on the assumption that unstuffed, chilled, ready-to-roast poultry, meat and fish are placed into a cold cooking compartment.

In the table, you can find specifications for poultry, meat and fish with default values for the weight. If you wish to prepare heavier poultry, meat or fish, use the lower temperature in every case. If roasting several joints, use the weight of the heaviest piece as a basis for determining the cooking time. The individual pieces should be approximately equal in size.

A general rule: the larger the poultry, meat or fish is, the lower the cooking temperature and the longer the cooking time.

Turn the poultry, meat and fish after approx. 1/2 to 2/3 of the indicated time.

Remove unused accessories from the cooking compartment. This will achieve the best possible cooking results and energy savings of up to 20 per cent.



Cooking time calculation (e. g. 20+35):

Please calculate the cooking time with 20 minutes per 500 g meat + 35 minutes additional time. For 1,5 kg the calculated cooking time would be 95 minutes.

Cooking time range (e. g. 10-15):





The food is done within the stated minutes.





























Types of heating used:

-  Circo-roasting
-  Full-surface grill

The levels of steam intensity are indicated as numbers in the table:

- 1 = Low
- 2 = Medium
- 3 = High

Dish	Accessories	Shelf position	Type of heating	Temperature in °C	Steam intensity	Time in min.
Beef						
Steaks, height 2-3 cm	wire rack	2		275	-	1st side 8-10 2nd side 5-7
Burger, height 1-2 cm	wire rack	2		275*	-	1st side 6-8 2nd side 4-6
Top side / Top rump	wire rack	2		150-160	-	30+30
Lamb						
Steaks, height 2-3 cm	wire rack	2		275*	-	1st side 8-10 2nd side 4-6
Chops, height 2-3 cm	wire rack	2		275	-	1st side 6-8 2nd side 6-8
* Preheat						
** Preheat 3 minutes						
*** Preheat 5 minutes						
**** Preheat 3 minutes, turn over several times						
***** Skin side down						

Dish	Accessories	Shelf position	Type of heating	Temperature in °C	Steam intensity	Time in min.
Leg (bone-in)	wire rack	1		170-180	-	25+30
Leg (bone-in), 1.5 kg	wire rack	1		170-180	1	80-90
Shoulder (bone-in)	wire rack	1		170-190	-	25+15
Shoulder (boned and rolled)	wire rack	1		170-180	-	20+15
Rack of lamb	wire rack	1		190-200	-	15+25
Pork						
Steaks, height 2 cm	wire rack	3		250	-	1st side 12-14 2nd side 6-8
Chops, height 2-3 cm	wire rack	2		275*	-	1st side 10-12 2nd side 9-10
Burger, height 1-2 cm	wire rack	2		275*	-	1st side 6-8 2nd side 4-6
Bacon rashers	wire rack	2		275***	-	1st side 5-6 2nd side 4-5
Sausages, thickness 2-4 cm	wire rack	2		275****	-	10-15
Roasting joint	wire rack	1		180-200	-	30-40
Loin joint	wire rack	1		170-180	-	35+35
Belly	wire rack	1		200-220	-	30+25
Belly, 1 kg	wire rack	1		170-180	1	50-60
				190-200	-	25-35
Gammon joint	wire rack	2		180-200	-	30+25
Poultry						
Chicken drumstick, 150 g each	wire rack	2		210-230	-	20-30
Chicken drumstick, 150 g each	wire rack	2		210-220	2	30-40
Chicken breast, boned, 150 g each	wire rack	2		275**	-	1st side 10-15 2nd side 10-15
Chicken breast, boned, 150 g each	wire rack	2		200-210	2	20-30
Chicken, whole	wire rack	1		200-220	-	25+15
Chicken, whole, 1.5 kg	wire rack	1		180-190	2	65-75
Chicken, portion, 200-250 g each****	wire rack	2		200-220	-	30-45
Chicken, portion, 200-250 g each****	wire rack	2		200-210	2	35-45
Duck, 2-3 kg	wire rack	1		190-200	-	20+20
Duck, 2-3 kg	wire rack	1		150-160	2	100-120
Turkey thighs	wire rack	1		180-190	-	25+30
Turkey, whole, 4-8 kg	wire rack	1		140-160	-	12+12
Fish						
Trout, whole, 300 g each	wire rack	1		170-190	-	20-30
Fillets, each 150 g	wire rack	2		220**	-	1st side 5-10 2nd side 5-10
* Preheat						
** Preheat 3 minutes						
*** Preheat 5 minutes						
**** Preheat 3 minutes, turn over several times						
***** Skin side down						

Dish	Accessories	Shelf position	Type of heating	Temperature in °C	Steam intensity	Time in min.
Toast						
Grilling white bread	wire rack	3		275	-	2-6
* Preheat						
** Preheat 3 minutes						
*** Preheat 5 minutes						
**** Preheat 3 minutes, turn over several times						
***** Skin side down						

Convenience products

Here, you can find the ideal settings for preparing chilled and frozen food.

Only use original accessories supplied with your appliance. These have been tailored to the cooking compartment and the operating modes of your appliance.

Tips

- The cooking result greatly depends on the quality of the food. Pre-browning and unevenness may already be present on the packaged product.
- Do not use frozen products that are heavily frosted. Remove any ice on the food.
- Distribute foods which are in pieces, such as bread rolls and potato products, so that they are spread flat and evenly on the accessories. Leave a little space between the individual pieces.
- Observe the instructions on the packaging.

Steam- assisted baking

Certain types of baked item (e.g. yeast-risen pastries) get a more crispy crust and a more glossy surface if baked with the steam assist mode. The baked item does not dry out as much.

Steam-assisted baking is only possible on one level.

Shelf positions

Use the indicated shelf positions.

Baking on one level

When baking on one level, use the following shelf position:

- Level 1

Baking on two levels

Use CircoTherm. Baked items that are placed into the oven on trays or in baking tins/dishes at the same time will not necessarily be ready at the same time.

- Universal pan: Level 3
Baking tray: Level 1

Accessories

Ensure that you always use suitable accessories and that they are placed in the oven the right way around.

Wire rack

Insert the wire rack with the open side facing the appliance door and the curved lip pointing downwards. Always place ovenware, tins and dishes on the wire rack.

Universal pan or baking tray

Slide the universal pan or the baking tray in carefully as far as the limit stop with the bevelled edge facing the appliance door.

Greaseproof paper

Only use greaseproof paper that is suitable for the selected temperature. Always cut greaseproof paper to size.

Recommended setting values

In the table, you can find the ideal heating type for various dishes. Temperature and cooking time depend on the quantity and composition of the product. Setting ranges are indicated for this reason. Try using the lower values at first. A lower temperature results in more even browning. You can use a higher setting next time if necessary.





Note: Cooking times cannot be reduced by using higher temperatures. The dish would only be cooked on the outside, but would not be fully cooked in the middle.

The setting values apply to dishes placed into a cold cooking compartment. By doing so, you can make energy savings of up to 20 per cent. If you preheat the oven, the indicated cooking times will be reduced by several minutes.

Preheating is necessary for selected dishes, and this is indicated in the table.

























Remove unused accessories from the cooking compartment. This will achieve the best possible cooking results and energy savings of up to 20 per cent.

Types of heating used:

-  CircoTherm
-  Top/bottom heating
-  Circotherm intensive
-  Bread baking

The levels of steam intensity are indicated as numbers in the table:

- 1 = Low
- 2 = Medium
- 3 = High

Dish	Accessories/cookware	Shelf position	Type of heating	Temperature in °C	Steam intensity	Cooking time in mins.
Pizza, chilled						
Pizza, chilled	wire rack	1		210-230	-	10-20
Pizza, frozen						
Pizza, thin base	wire rack	1		210-230	-	10-20
Pizza, thin base, 2 levels	2 wire racks	3+1		200-220	-	15-25
Pizza, thick base	wire rack	1		190-210	-	20-30
Pizza, thick base	wire rack	1		180-200	-	20-30
Pizza, thick base, 2 levels	2 wire racks	3+1		160-180	-	25-35
Pizza baguette	wire rack	1		200-220	-	20-30
Potatoe products, frozen						
Oven chips*	baking tray	1		190-210	-	20-30
Oven chips, 2 levels*	universal pan + baking tray	3+1		200-220	-	30-40
Croquettes*	baking tray	1		210-230	-	15-25
Hash browns*	universal pan	2		200-220	-	20-30
Potatoe wedges	baking tray	1		200-220	-	20-30
Baked goods, frozen, prebaked						
Rolls, baguettes	universal pan	2		200-220	-	15-25
Rolls, baguettes	universal pan	2		180-200	1	15-25
Rolls, baguettes, 2 levels	grid + universal pan	3+1		160-180	-	15-25
Fried food, frozen						
Fish fingers*	baking tray	1		220-240	-	10-20
Chicken nuggets	universal pan	2		200-220	-	10-20
Food, chilled						
Lasagna, 500 g	ovenproof dish on wire rack	1		180-200	-	30-40
Lasagna, 500 g	ovenproof dish on wire rack	1		180-190	2	30-40
Lasagna, 1,5 kg	ovenproof dish on universal pan	1		180-200	-	35-45
Lasagna, 1,5 kg	ovenproof dish on wire rack	1		160-170	2	35-45
Food, frozen						
Lasagna, 500 g	ovenproof dish on universal pan	1		190-210	-	30-40
Lasagna, 500 g	ovenproof dish on wire rack	1		180-190	2	40-50
Lasagna, 1,5 kg	ovenproof dish on universal pan	1		160-180	-	60-80
Lasagna, 1,5 kg	ovenproof dish on wire rack	1		160-170	2	45-55

* Turn during cooking

Steaming

Only use original accessories. When steaming in the perforated steam container (size XL), always slide the universal pan in underneath as well. Dripping liquid is caught.

Steaming on one level

Use the shelf positions indicated in the settings tables.

Steaming on two levels

Steaming on two levels is very well suited to simultaneously cooking broccoli and potatoes, for example. In cases where the cooking times are

different, insert the foodstuff with the shorter cooking time later.

- Wire rack and attached steam container (size S), perforated and/or unperforated: Level 3
- Perforated steam container (size XL): Level 2

Cookware

If you use cookware, place it onto the wire rack or the perforated steam container, size XL.

Ovenware must be heat and steam resistant. Cooking times are increased when using cookware with thick edges.

Food which would normally be prepared in a water bath should always be covered with foil.

Cooking time and quantity

Cooking times when steaming are dependent on the size of the pieces, but not dependent on the total quantity. If a larger total quantity is used, the heating-up time is increased and not the cooking time.

Larger pieces require a longer heating-up time and a longer cooking time. If you are using several pieces which are the same weight, the heating-up time is increased, and not the cooking time.

Observe the unit sizes indicated in the settings table. The cooking time is reduced for smaller pieces and increased for larger ones. Cooking time is also influenced by the quality and ripeness of the food. This means that the setting values indicated are purely guidelines.

Always distribute the food evenly in the cookware. It will not cook evenly if the layers are of different depths. When layering delicate foods in the cooking container, do not pile them too high. It is better to use two containers.

Rice and cereals

Add water or liquid in the proportion indicated. E.g. "1:1.5" means adding 150 ml liquid per 100 g rice.

Menu cooking

With your appliance you can cook a whole menu at once without the different flavours or aromas mixing with each other.

Place the food with the longest cooking time in the appliance first and add the rest at the appropriate time. This means that all the food will be ready at the same time.

The overall cooking time is extended with menu cooking, as a little steam escapes each time the appliance door is opened and has to be reheated.

Observe the information in the relevant paragraphs of this section:

- The heating-up time varies depending on the size and weight of the food
- The cooking time does not depend on the quantity
- Use cookware that is steam-resistant
- Cover soufflé with foil
- Always insert the universal pan at level 1

Shelf positions for accessories

Always insert accessories in the following order:

- Level 3: Wire rack with steam container, size S
- Level 2: Steam container, size XL
- Level 1: Universal pan

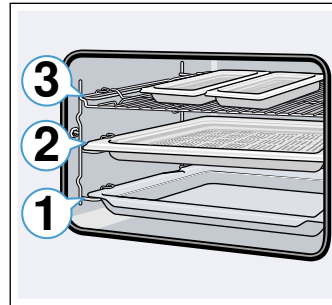

Making rice pudding

1. Weigh the rice and add 2.5 times as much milk.
2. Fill a bowl with the rice and milk so that the mixture is max. 2.5 cm deep.
You can also use the universal pan for large quantities.
3. Use the settings indicated in the table.
4. Stir after cooking.
The remaining milk is quickly absorbed.

Compote

Weigh the fruit and add approx. 1/3 as much water. Add sugar and spices to taste. Use the settings indicated in the table.

Crème caramel and soufflé

Place the small dishes directly into the perforated steam container (size XL). A water bath is not required. Use the settings indicated in the table.

Food which would normally be prepared in a water bath should always be covered with foil.

Dampfnudeln (steamed bread rolls)

Prepare the yeast dough according to your recipe without cooking. Place the shaped balls into a greased, perforated steam container (size XL), and allow them to prove. Use the settings indicated in the table.

Recommended setting values

Type of heating used:

- ☁️ Steam cooking

Dish	Accessories/cookware	Shelf position	Type of heating	Temperature in °C	Cooking time in mins.
Poultry					
Chicken breast, 150 g each	steam container	2	☁️	100	15-25
Pork					
Pork fillet, 400 g	steam container	2	☁️	100	18-20
Fish					
Fish, whole 300 g, e.g. trout	steam container, perforated	2	☁️	80-90	15-25
Fish, whole 1,5 kg, e.g. cod	steam container, perforated	2	☁️	80-90	35-50
Fish fillet, 200 g	steam container, perforated	2	☁️	80-100	10-16

Dish	Accessories/cookware	Shelf position	Type of heating	Temperature in °C	Cooking time in mins.
Fish, frozen					
Fish, whole 300 g, e.g. trout	steam container, perforated	2	☁	80-100	20-25
Fish dishes					
Fish terrine	bain marie	2	☁	70-80	45-80
Potatoes					
Unpeeled boiled potatoes	steam container, perforated	2	☁	100	35-45
Boiled potatoes, quartered	steam container, perforated	2	☁	100	20-25
Vegetables, fresh					
Artichokes, whole	steam container, perforated	2	☁	100	30-35
Cauliflower, whole	steam container, perforated	2	☁	100	25-35
Broccoli, florets	steam container, perforated	2	☁	100	6-9
Green beans	steam container, perforated	2	☁	100	18-25
Carrots, slices	steam container, perforated	2	☁	100	10-20
Cabbage turnip, slices	steam container, perforated	2	☁	100	17-20
Leek, slices	steam container, perforated	2	☁	100	6-9
Sweetcorn, whole	steam container, perforated	2	☁	100	30-40
Beetroot, whole	steam container, perforated	2	☁	100	43-50
White asparagus, whole	steam container, perforated	2	☁	100	7-15
Spinach	steam container, perforated	2	☁	100	2-3
Courgette, slices	steam container, perforated	2	☁	100	3-4
Vegetables, frozen					
Cauliflower	steam container, perforated	2	☁	100	15-25
Green beans	steam container, perforated	2	☁	100	5-8
Broccoli	steam container, perforated	2	☁	100	6-10
Peas	steam container, perforated	2	☁	100	6-10
Carrots	steam container, perforated	2	☁	100	3-10
Brussel sprouts	steam container, perforated	2	☁	100	4-6
Mixed vegetables, 1 kg	steam container, perforated	2	☁	100	5-10
Rice					
Basmati rice, 1:1,5	cookware, flat	1	☁	100	10-15
Long-grain rice, 1:1,5	cookware, flat	1	☁	100	20-30
Brown rice, 1:1,5	cookware, flat	1	☁	100	30-40
Parboiled rice, 1:1,5	cookware, flat	1	☁	100	15-20
Risotto, 1:2	cookware, flat	1	☁	100	25-35
Cereals					
Couscous, 1:1	cookware, flat	1	☁	100	6-10
Millet, whole, 1:1,25	cookware, flat	1	☁	100	25-35
Polenta, 1:5	cookware, flat	1	☁	100	20-45
Egg					
Hard-boiled eggs	steam container, perforated	2	☁	100	9-11
Soft-boiled eggs	steam container, perforated	2	☁	100	6-8
Dessert					
Crème Brulée	individual moulds	1	☁	85	20-30

Dish	Accessories/cookware	Shelf position	Type of heating	Temperature in °C	Cooking time in mins.
Crème caramel	individual moulds	1	☰	85	25-35
Soufflé	individual moulds	1	☰	100	40-45
Yeast dumplings	universal pan	1	☰	100	25-30
Rice pudding, 1:2,5	universal pan	1	☰	100	25-35
Fruit compote, 1/3 water	universal pan	1	☰	100	10-20
Complete meal					
Frozen salmon fillet	steam container, solid, size S	3	☰	100	20
Broccoli, florets	steam container, perforated, size XL	2	☰	100	9
Potatoes boiled	steam container, perforated, size S	3	☰	100	25

Yogurt

You can make your own yogurt using your appliance.

Making yoghurt

Remove accessories and shelf supports from the cooking compartment. The cooking compartment must be empty. Do not open the appliance door while the appliance is in operation.

1. Heat 1 litre of milk (3.5% fat) to 90 °C on the hob and then leave it to cool down to 40 °C. It is sufficient to heat UHT milk to 40 °C.

2. Stir in 150 g (chilled) yoghurt.
3. Pour into cups or small jars and cover with cling film.
4. Place the cups or jars onto the cooking compartment floor and use the settings indicated in the table.
5. After making the yoghurt, leave it to cool in the refrigerator.

Type of heating used:

- ☰ Dough proving

Dish	Cookware	Shelf position	Type of heating	Dough proving setting	Cooking time in hours
Yoghurt	individual moulds	cooking compartment floor	☰	1	5-6

Eco heating functions

CircoTherm eco and Top/bottom heating eco are intelligent heating functions that allow you to gently cook meat, fish and baked items. The appliance optimally controls the supply of energy to the cooking compartment. The food is cooked in phases using residual heat. This means that it remains more succulent and browns less. Depending on the method of preparation and the type of food, it is possible to save energy. If you open the appliance door before the food has finished cooking or if you preheat the appliance, you may not be able to achieve this result.

Only use genuine accessories for your appliance. These have been tailored to the cooking compartment and the operating modes of your appliance. Remove any accessories that are not being used from the cooking compartment.

Place the food into the empty cooking compartment before the oven is heated up. For CircoTherm eco, select a temperature of between 125 and 200 °C, and for Top/bottom heating eco, select a temperature of between 150 and 250 °C. Always keep the appliance door closed when cooking. Only cook on one level when using this function.

The CircoTherm eco heating function is used to measure both the energy consumption in air recirculation mode and the energy efficiency class. The Top/bottom heating eco heating function is used to

measure the energy consumption in the conventional mode.

Accessories

Ensure that you always use suitable accessories and that they are placed in the oven the right way around.

Wire rack

Insert the wire rack with the open side facing the appliance door and the curved lip pointing downwards. Always place ovenware, tins and dishes on the wire rack.

Universal pan or baking tray

Slide the universal pan or the baking tray in carefully as far as the limit stop with the bevelled edge facing the appliance door.

Baking tins and cookware

Dark- coloured metal baking tins are most suitable. These allow you to make energy savings of up to 35 per cent.

Cookware made from stainless steel or aluminium reflects heat like a mirror. Non-reflective cookware made from enamel, heat-resistant glass or coated, die-cast aluminium is more suitable.

Tinplate baking tins, ceramic dishes or glass dishes prolong baking time, and the cake will not brown so evenly.

Greaseproof paper

Only use greaseproof paper that is suitable for the selected temperature. Always cut greaseproof paper to size.



Recommended setting values





















Here, you can find specifications for the various dishes with CircoTherm Eco and Top/bottom heating Eco. The temperature and baking time depend on the consistency and amount of the dough. Settings ranges are indicated for this reason. Try with the lower values first. A lower temperature results in more even

browning. You can increase the temperature next time if necessary.

Note: Baking times can not be reduced by using higher temperatures. Cakes or baked items would only be cooked on the outside, but would not be fully cooked in the middle.

Types of heating used:

-  CircoTherm eco
-  Top/bottom heating Eco

Dish	Accessories/cookware	Shelf position	Type of heating	Temperature in °C	Cooking time in mins.
Baking					
Victoria sponge cake	2x Ø20 cm tins	1		170-180	25-35
Light fruit cake	high Ø20 cm tin	1		150-170	70-90
Rich Fruit Cake	high Ø23 cm tin	1		140-160	120-180
Fruit crumble	flat glass dish	1		160-180	40-60
Sponge cake (fatless), 3 eggs	springform cake tin, Ø26 cm	1		160-170	25-35
Swiss Roll	swiss roll tin	1		180-200	10-20
Fruit Pie	plate Ø20 cm or pie tin	1		170-190	60-75
Quiche	quiche tin (dark coated)	1		190-200	35-45
(White) Bread	loaf tin (1x 900 g or 2x 450 g)	1		190-200	45-55
Scones	baking tray	1		190-210	15-20
Biscuits	baking tray	2		140-160	15-30
Jam tarts	12-cup-tin	1		170-190	15-30
Soufflé	1,2 L-soufflé dish	1		160-170	40-50
Meat Pie	rectangular pie tin	1		190-210	40-55
Jacket potatoes	baking tray	2		150-170	60-90
Meat					
Beef, slow roast joint	wire rack	1		140+150	35+40
Casserole					
Diced meat (beef, pork, lamb), 500 g meat	cookware, covered	1		140	100-120
Braising steak	cookware, covered	1		140	65+60
Fish					
Fish, braised, whole 300 g, e.g. trout	cookware, covered	1		190-210	25-35
Fish, braised, whole 1,5 kg, e.g. salmon	cookware, covered	1		190-210	45-55
Fish fillet, plain, braised, 100 g	cookware, covered	1		190-210	15-35

Acrylamide in foodstuffs

Acrylamide is mainly produced in grain and potato products prepared at high temperatures, such as potato

crisps, chips, sliced bread, bread rolls, bread or fine baked goods (biscuits, gingerbread, spiced biscuit).

Tips for keeping acrylamide to a minimum	
General	<ul style="list-style-type: none"> ■ Keep cooking times as short as possible. ■ Cook food until it is golden brown, but not too dark. ■ Large, thick pieces of food contain less acrylamide.
Baking	<p>With top/bottom heating at max. 200 °C.</p> <p>With hot air at max. 180 °C.</p>

Tips for keeping acrylamide to a minimum

Biscuits	With top/bottom heating at max. 190 °C. With hot air at max. 170 °C. Egg or egg yolk reduces the production of acrylamide.
Oven chips	Spread out a single layer evenly on the baking tray. Cook at least 400 g at once on a baking tray so that the chips do not dry out.

Slow cook

Slow cooking is a technique for cooking food over a long period at low temperatures. For this reason, it is also called "low-temperature cooking".

Slow cooking is ideal for all prime cuts (e.g. tender portions of beef, veal, pork, lamb or poultry) which are to be cooked "à point". The meat will remain succulent and tender.

The benefit of this cooking method is that it allows lots of scope for menu planning because slow-cooked meat is easy to keep warm. You do not have to turn the meat when cooking. Keep the appliance door closed in order to maintain an even cooking climate.

Only use fresh, clean and hygienic meat without bones. Carefully remove sinews and fat from around the edge. Fat develops a strong, distinct flavour during slow cooking. You can also use seasoned or marinated meat. Do not use defrosted meat.

Meat can be carved immediately following slow cooking. No standing time is required. Due to the special cooking method, the meat looks pink, but is not raw or undercooked.

Note: Delayed-start operation with an end time is not possible for the slow cooking heating type.

Cookware

Use flat cookware, e.g. a glass/porcelain serving dish. Place the cookware into the cooking compartment to preheat it.

Always place the uncovered cookware onto the wire rack at level 1.

You can find additional information in the tips on slow cooking attached to the settings table.

Your appliance features the heating type "Slow cook". Only start operation when the cooking compartment has fully cooled down. Allow the cooking compartment to warm up for around 10 minutes with the cookware inside.









Sear the meat on the hotplate at a very high heat and for a sufficiently long time on all sides, even on the ends. Place into the preheated cookware right away. Place the cookware containing the meat into the cooking compartment once again and cook slowly.

Recommended setting values

The slow cooking temperature and cooking time are dependent on the size, thickness and quality of the meat. Different settings ranges are indicated for this reason.

Type of heating used:

■  Low temperature cooking

Dish	Cookware	Shelf position	Heating function	Searing time in mins	Temperature in °C	Cooking time in mins
Poultry						
Duck breast, medium rare, 300 g each	Cookware, uncovered	1		6-8	95*	45-60
Chicken breast fillet, 200 g each, well done	Cookware, uncovered	1		4	120*	45-60
Turkey breast, boned, 1 kg, well done	Cookware, uncovered	1		6-8	120*	100-130
Pork						
Pork tenderloin steak, 5-6 cm thick, 1.5 kg	Cookware, uncovered	1		6-8	85*	130-180
Fillet of pork, whole	Cookware, uncovered	1		4-6	85*	45-70
Beef						
Joint of beef (rump), 6-7 cm thick, 1.5 kg	Cookware, uncovered	1		6-8	100*	150-190
Fillet of beef, 1 kg	Cookware, uncovered	1		4-6	85*	90-120
Sirloin, 5-6 cm thick	Cookware, uncovered	1		6-8	85*	120-180
Beef medallions/rump steak, 4 cm thick	Cookware, uncovered	1		4	85*	40-60
* Preheat						

Dish	Cookware	Shelf position	Heating function	Searing time in mins	Temperature in °C	Cooking time in mins
Veal						
Joint of veal, 4-5 cm thick, 1.5 kg	Cookware, uncovered	1		6-8	85*	100-130
Joint of veal, 7-10 cm thick, 1.5 kg	Cookware, uncovered	1		6-8	85*	150-210
Fillet of veal, whole, 800 g	Cookware, uncovered	1		4-6	85*	70-120
Veal medallions, 4 cm thick	Cookware, uncovered	1		4	80*	40-60
Lamb						
Saddle of lamb, boneless, 200 g each	Cookware, uncovered	1		4	85*	30-45
Leg of lamb, boned, medium, 1 kg, tied	Cookware, uncovered	1		6-8	95*	120-180
* Preheat						

Tips for slow cooking

Slow-cooking duck breast.	Place the cold duck breast into a pan and fry the skin side first. After slow cooking, grill for 3 to 5 minutes until crispy.
The slow-cooked meat is not as hot as conventionally roasted meat.	So that the roasted meat does not cool so quickly, warm the plates and serve the sauces very hot.

Drying

You can achieve outstanding drying results with CircoTherm. With this type of preserving, flavourings are concentrated by the dehydration.

Only use unblemished fruit, vegetables and herbs and wash them thoroughly. Line the wire rack with greaseproof paper or parchment paper. Drain the excess water from the fruit and dry it.

If necessary, cut it into equal chunks or thin slices. Place unpeeled fruit onto the dish with the sliced surfaces facing upwards. Ensure that neither fruit nor mushrooms overlap on the wire rack.

Grate vegetables and then blanch them. Allow the blanched vegetables to drain off and distribute them evenly on the wire rack.

Dry herbs on the stem. Position the herbs evenly and slightly heaped on the wire rack.

Use the following shelf positions when drying:

- 1 wire rack: Level 2
- 2 wire racks: Level 3+1

Turn very juicy fruit and vegetables several times. After drying, remove the dried products from the paper immediately.

Recommended setting values

In the table, you can find settings for drying various foodstuffs. The temperature and cooking time are dependent on the type, moisture, ripeness and thickness of the food to be dried. The longer you leave the food to be dried, the better it will be preserved. The thinner the slices are, the quicker the drying process will be and the more aromatic the dried food will remain. Setting ranges are indicated for this reason.

If you wish to dry additional foodstuffs, you should use similar foodstuffs in the table as a reference.

Type of heating used:

-

Dish	Accessories	Shelf position	Type of heating	Temperature in °C	Cooking time in hours
Pomes (apple rings, 3 mm thick, 200 g per wire rack)	Wire rack	2		80	4-7
Stone fruit (plums)	Wire rack	2		80	8-10
Root vegetables (carrots), grated, blanched	Wire rack	2		80	4-7
Sliced mushrooms	Wire rack	2		60	6-8
Herbs, washed	1-2 wire racks	-		60	2-6

Preserving and juicing

Your appliance is also suitable for preserving and juicing.

Preserving

You can preserve fruit and vegetables using your appliance.

Warning – Risk of injury!

If the food is preserved incorrectly, the preserving jars may burst. Follow the instructions for preserving.

Jars

Use only clean and undamaged preserving jars. Only use heat-resistant, clean and undamaged rubber rings. Check clips and clamps in advance.

Tip: You can use the disinfecting function to clean the jars.

For each preserving process, only use preserving jars that are the same size and contain the same food. In the cooking compartment, you can preserve the contents of a maximum of six ½, 1 or 1½-litre preserving jars at the same time. Do not use jars that are larger or taller than this. The lids could rupture.

Preserving jars must not touch one another in the cooking compartment during the preserving process.

Preparing fruit and vegetables

Only use fruit and vegetables that are in good condition. Wash them thoroughly.

Peel, core and chop fruit and vegetables appropriate to their type and fill the preserving jars with them up to approx. 2 cm below the rim.

Fruit: Fill the preserving jars with the fruit along with a hot, skimmed sugar solution (approx. 400 ml for a 1-litre jar). For one litre of water:

- Approx. 250 g sugar for sweet fruit
- Approx. 500 g sugar for sour fruit

Vegetables: Fill the jars with the vegetables along with hot, boiled water.

Wipe the rims of the jars, as they must be clean. Place a damp rubber ring and a lid on each jar. Seal the jars with clamps. Place the jars into the perforated steam container (size XL) so that they do not touch each other. Use the settings indicated in the table.

Ending the preserving process

After the specified cooking time, open the appliance door. Do not remove the preserving jars from the cooking compartment until they have completely cooled down.

Wipe the cooking compartment clean afterwards.

Juicing

Before juicing, place the berries in a bowl and sprinkle with sugar. Leave to stand for at least one hour to draw out the juice.

Then fill the perforated steam container (size XL) with the berries and insert into the oven at level 2. Slide the universal pan in underneath to collect any juice. Use the settings indicated in the table.

After cooking, wrap the berries in a cloth and squeeze out the remaining juice.





Wipe the cooking compartment clean afterwards.

Recommended setting values

The times indicated in the settings table are guideline values for preserving fruit and vegetables and for juicing fruit. They may be influenced by room temperature, number of jars, quantity, heat and the quality of the jar contents. The specifications are based on 1-litre round jars.

Type of heating used:

-  Steam cooking

Dish	Accessories/cookware	Shelf position	Type of heating	Temperature in °C	Cooking time in mins.
Preserving					
Vegetables, e.g. carrots	1-litre preserving jars + XL steam container	1		100	30-120
Stone fruit, e.g. cherries, damsons	1-litre preserving jars + XL steam container	1		100	25-30
Pomes, e.g. apples, strawberries	1-litre preserving jars + XL steam container	1		100	25-30
Juicing					
Raspberries	Steam container	2		100	30-45
Redcurrants	Steam container	2		100	40-50

Sterilising bottles and hygiene

Using your appliance, you can very easily sterilise cookware and baby feeding bottles. The process corresponds to normal sterilisation by boiling.

Sterilising bottles

Always clean the bottles with a bottle brush immediately after use. Then clean them in the dishwasher.

Place the bottles into the steam container, size XL, so that they do not touch each other. Start the programme "Sterilising". After sterilising, wipe the appliance down inside. Dry the bottles with a clean cloth after sterilising.

Hygiene

Your appliance is also suitable for preparing jam jars or preserving jars and their corresponding lids.

Post-treatment of jam is also possible. This improves the storage life of the jam.



Recommended setting values

Only use clean, intact jars and lids. They should ideally be cleaned in the dishwasher in advance. Cookware must be heat- and steam-resistant.

The recommended times are dependent on the jars used.

Type of heating used:

-  Steam cooking

Dish	Accessory	Shelf position	Type of heating	Temperature in °C	Cooking time in mins.
Hygiene					
Preparing jam jars or preserving jars	XL steam container	1		100	10-15
Post-treating jam jars	XL steam container	1		100	15-20
Sterilising clean cookware*	XL steam container	1		100	15-20
* This process corresponds to normal sterilisation by boiling.					

Allowing the dough to prove at dough proving setting

Yeast dough will prove considerably more quickly using the "Dough proving" heating type than at room temperature and does not dry out. Only start operation when the cooking compartment has fully cooled down.

Always allow yeast dough to prove twice. Observe the specifications in the settings tables for the 1st and 2nd proving processes (dough fermentation and final fermentation).

Dough fermentation

Position the dough bowl on the wire rack for the dough fermentation. Use the settings indicated in the table.

Do not open the appliance door during the proving process, as moisture will escape. Do not cover the dough.

Final fermentation

Place your baked item into the oven at the shelf position indicated in the table.







Wipe moisture from the cooking compartment before baking.

Recommended setting values

The temperature and proving time are dependent on the type and quantity of the ingredients. The values in the table are therefore only meant to be average values.

Type of heating used:

-  Dough proving

Dish	Accessories/cookware	Shelf position	Type of heating	Step	Dough proving setting	Cooking time in mins.
Yeast dough, sweet						
E.g. small baked items	Bowl	1		Dough fermentation	1	30-45
	Universal pan	1		Final fermentation	1	10-20
Rich dough, e.g. panettone	Bowl	1		Dough fermentation	2	40-90
	Tin on wire rack	1		Final fermentation	2	30-60
Yeast dough, savoury						
E.g. pizza	Bowl	1		Dough fermentation	1	20-30
	Universal pan	1		Final fermentation	1	10-15

Dish	Accessories/cookware	Shelf position	Type of heating	Step	Dough proving setting	Cooking time in mins.
Bread dough						
White bread	Bowl	1	☰	Dough fermentation	1	30-40
	Universal pan	1	☰	Final fermentation	1	15-25
Multigrain bread	Bowl	1	☰	Dough fermentation	1	25-40
	Universal pan	1	☰	Final fermentation	1	10-20
Bread rolls	Bowl	1	☰	Dough fermentation	1	30-40
	Universal pan	1	☰	Final fermentation	1	15-25

Defrosting

The defrost setting is suitable for defrosting frozen fruit and vegetables. Use the heating type 4D hot air to defrost baked items. Poultry, meat and fish should ideally be defrosted in the refrigerator.

Remove frozen food from any packaging when defrosting it.

Place frozen fruit and vegetables into the perforated steam container (size XL) and slide the universal pan in underneath. This means that the food does not remain in the meltwater and that any dripping liquid will be caught. Use the universal pan or cookware on the wire rack for frozen food where liquid should remain in the dish, e.g. frozen creamed spinach.

Place the baked item onto the wire rack.

Recommended setting values

The times in the table are average values. They are dependent on the quality, freezing temperature (-18 °C) and composition of the food. Time ranges are indicated. Set the shortest time first and then increase the time if necessary.

Tip: Items which were frozen flat or portioned defrost faster than those frozen in a block.

Types of heating used:

- ☰ CircoTherm
- ☼ Defrost setting

Dish	Accessories	Shelf position	Type of heating	Temperature in °C	Cooking time in mins.
Bread, bread rolls					
General	Baking tray	1	☰	50	40-70
Cake					
Cake, moist	Baking tray	1	☰	50	70-90
Cake, dry	Baking tray	1	☰	60	60-75
Fruit, vegetables					
Berries	Steam container	2	☼	30-40	10-15
Vegetables	Steam container	2	☼	40-50	15-50

Reheating

Using heating type "Reheating", food is reheated gently using steam. It tastes and looks as though it has been freshly prepared. Even baked items from the day before can be re-crisped.

Use containers which are as flat, wide and heat-resistant as possible. Cold containers prolong the reheating process.

Where possible, only reheat dishes of the same size and type at the same time. If this is not possible, the time required for the component with the longest reheating time should be used as a basis.

Do not cover food while it is being reheated.

Place the food in the cookware onto the wire rack or place it directly onto the wire rack at level 1.

Do not open the appliance door during operation, as a lot of steam will escape.

Recommended setting values











In the table, you can find the ideal settings for various dishes. The times specified are only average values. They are dependent on the cookware used, the quality, temperature and consistency of the food. Time ranges are indicated. Set the shortest time first and then extend the time if necessary.

The values in the table apply to dishes placed into a cold cooking compartment. Preheating is necessary for selected dishes, and this is indicated in the table.

Remove unused accessories from the cooking compartment. This will allow you to achieve ideal cooking results and save energy.

Type of heating used:

-  Reheat

Dish	Accessories/cookware	Shelf position	Type of heating	Temperature in °C	Cooking time in mins.
Vegetables, chilled					
1 kg	Cookware, uncovered	1		120-130	15-25
250 g	Cookware, uncovered	1		120-130	5-15
Dishes, chilled					
Plated meal, 1 portion	Cookware, uncovered	1		120-130	15-25
Soup, stew, 400 ml	Cookware, uncovered	1		120-130	10-25
Side dishes, e.g. pasta, dumplings, potatoes, rice	Cookware, uncovered	1		120-130	8-25
Bakes, e.g. lasagne, potato gratin	Cookware, uncovered	1		120-140	10-25
Pizza, cooked	Wire rack	1		170-180*	5-15
Baked goods					
Bread rolls, baguette, baked	Wire rack	1		150-160*	10-20
Pastries (vol-au-vents)	Wire rack	1		180*	4-10
Baked goods, frozen					
Pizza, cooked	Wire rack	1		170-180*	5-15
Bread rolls, baguette, baked	Wire rack	1		160-170*	10-20
* Preheat					

Keeping warm

You can keep cooked dishes warm using the "Keeping warm" heating type. You can use the various moisture levels to prevent the cooked dishes from drying out.

Do not cover the food.

Do not keep cooked dishes warm for longer than two hours. Be aware that some dishes may continue cooking whilst being kept warm. Do not cover the food.

The various steam levels are suitable for keeping the following foods warm:

- Level 1: Roasted joints and pan-fried foods
- Level 2: Bakes and side dishes
- Level 3: Stews and soups

Test dishes

These tables have been produced for test institutes to facilitate appliance testing.

As per EN 60350-1.

Baking

Baked items that are placed into the oven on trays or in baking tins/dishes at the same time will not necessarily be ready at the same time.

Shelf positions for baking on two levels:

- Universal pan: Level 3
- Baking tray: Level 1

Apple pie



Apple pie on one level: place dark-coloured springform cake tins diagonally next to each other.

Cakes in tinplate springform cake tins: bake on one level with top/bottom heating. Place the springform cake tin onto the universal pan instead of onto the wire rack.

Notes











- The setting values apply to dishes placed into a cold cooking compartment.
- Please note the information in the tables about preheating. The setting values are valid without rapid heating-up.
- For baking, use the lower of the indicated temperatures first.

Types of heating used:

-  CircoTherm
-  Top/bottom heating
-  Circotherm intensive

The levels of steam intensity are indicated as numbers in the table:

- 1 = Low
- 2 = Medium
- 3 = High

Dish	Accessories/cookware	Shelf position	Type of heating	Temperature in °C	Steam intensity	Cooking time in mins.
Baking						
Shortbread	Baking tray	1		150-160*	-	25-40
Shortbread	Baking tray	1		140-150*	-	25-35
Shortbread, 2 levels	Universal pan + baking tray	3+1		140-150*	-	30-40
Small cakes	Baking tray	1		160*	-	25-35
Small cakes	Baking tray	1		150*	-	25-35
Small cakes, 2 levels	Universal pan + baking tray	3+1		150*	-	25-35
Fatless sponge cake	Springform cake tin, diameter 26 cm	1		160-170**	-	25-35
Fatless sponge cake	Springform cake tin, diameter 26 cm	1		160-170**	-	25-35
Fatless sponge cake	Springform cake tin, diameter 26 cm	1		150-160	1	10
					-	20-30
Apple pie	2 x black plate tins, diameter 20 cm	1		180-200	-	60-70
Apple pie	2 x black plate tins, diameter 20 cm	1		170-180	-	60-80
* Preheat for 5 mins, do not use quick heat function						
** Preheat, do not use quick heat function						

en Tested for you in our cooking studio

Steam

Slide the universal pan in under the perforated steam container (size XL) if indicated in the table. Any dripping liquid is caught.

Shelf positions for steaming on one level (use a maximum of 2.5 kg):



- Perforated steam container (size XL): Level 2

Shelf positions for steaming on two levels (use a maximum of 1.8 kg per level):

- Perforated steam container (size XL): Level 3
- Perforated steam container (size XL): Level 2

Type of heating used:

-  Steam cooking

Dish	Accessories	Shelf position	Type of heating	Temperature in °C	Cooking time in mins.
Steam					
Peas, frozen, two containers, 1.8 kg each	XL steam container x 2 + universal pan	3+2+1		100	3-15**
Broccoli, fresh, 300 g	XL steam container	2		100*	6-7***
Broccoli, fresh, one container	XL steam container	2		100*	6-7***
* Preheat					
** Test is over when 85°C is reached at the coldest spot (see IEC 60350-1)					
*** A comparable degree of cooking between reference sample and main sample is achieved if the reference sample is cooked for 5 minutes (produced as described in IEC 60350-1).					

Grilling

Also slide in the universal pan. The liquid will be caught and the cooking compartment stays cleaner.

Type of heating used:

-  Full-surface grill

Dish	Accessories	Shelf position	Type of heating	Temperature in °C	Cooking time in mins.
Grilling					
Browning toast	Wire rack	3		275	2-6
Beefburgers, x 12*	Wire rack	2		275	20-30
* Turn after 2/3 of the total time					



Blank lined writing area with horizontal lines extending across the page.



REGISTER YOUR PRODUCT
ONLINE NEFF-HOME.COM



Constructa NEFF Vertriebs-GmbH |
Carl-Wery-Straße 34 | 81739 Munich | Germany

9001421264
981010
en