



BUILT-IN OVEN

[en] INSTRUCTION MANUAL

B4AVH1AH0B

Table of contents

	Intended use	4		Childproof lock	18
	Automatic childproof lock	18		One-time childproof lock	18
	Important safety information	5		Basic settings	19
	General information	5		List of basic settings	19
	Halogen lamp	6		Changing the basic settings	19
	Steam	6		Programmes	20
	Causes of damage	6		Information on the settings	20
	General information	6		Selecting a dish	20
	Steam	7		Setting a program	21
	Environmental protection	7		Sabbath mode	21
	Saving energy	7		Starting Sabbath mode	21
	Environmentally-friendly disposal	8		Home Connect	22
	Getting to know your appliance	9		Setting up	22
	Control panel	9		Remote Start	22
	Buttons and display	9		Home Connect settings	22
	Types of heating and functions	10		Remote diagnostics	23
	Temperature	11		About data protection	23
	Cooking compartment	11		Declaration of Conformity	23
	Accessories	11		Cleaning agent	23
	Control accessories	11		Suitable cleaning agents	23
	Inserting accessories	11		Surfaces in the cooking compartment	24
	Optional accessories	12		After cleaning	25
	Before using for the first time	13		Keeping the appliance clean	25
	Before using for the first time	13		Cleaning function	25
	Initial use	13		Descaling	25
	Cleaning the cooking compartment	13		Rails	26
	Cleaning the accessories	13		Detaching and refitting the rails	26
	Operating the appliance	14		Appliance door	27
	Switching the appliance on and off	14		Removing and fitting the appliance door	27
	Setting the type of heating and temperature	14		Removing and installing the door panels	29
	Temperature display	14		Trouble shooting	30
	Rapid heating	14		Rectifying faults yourself	30
	Steam	15		Maximum operating time	31
	Steam-assisted cooking	15		Replacing the bulb in the top of the cooking compartment	31
	Reheating	15		Customer service	32
	Filling the water tank	15		E number and FD number	32
	After every steam operation	16			
	Time-setting options	17			
	Setting the timer	17			
	Setting the cooking time	17			
	Setting the end time	17			
	Setting the time	18			
	Checking, changing or deleting settings	18			



Tested for you in our cooking studio. 33

General information 33
 Baking 34
 Roasting, braising and grilling 36
 Ready meals 40
 Desserts 41
 Acrylamide in foodstuffs 41
 Drying 42
 Preserving 42
 Prove dough 43
 Defrosting 44
 Keeping warm 44
 Test dishes 44

Additional information on products, accessories, replacement parts and services can be found at **www.neff-international.com** and in the online shop **www.neff-eshop.com**



Intended use

Read these instructions carefully. Only then will you be able to operate your appliance safely and correctly. Retain the instruction manual and installation instructions for future use or for subsequent owners.

This appliance is only intended to be fully fitted in a kitchen. Observe the special installation instructions.

Check the appliance for damage after unpacking it. Do not connect the appliance if it has been damaged in transport.

Only a licensed professional may connect appliances without plugs. Damage caused by incorrect connection is not covered under warranty.

This appliance is intended for domestic use only. The appliance must only be used for the preparation of food and drink. The appliance must be supervised during operation. Only use this appliance indoors.

This appliance is intended for use up to a maximum height of 4000 metres above sea level.

This appliance may be used by children over the age of 8 years old and by persons with reduced physical, sensory or mental capabilities or by persons with a lack of experience or knowledge if they are supervised or are instructed by a person responsible for their safety how to use the appliance safely and have understood the associated hazards.

Children must not play with, on, or around the appliance. Children must not clean the appliance or carry out general maintenance unless they are at least 15 years old and are being supervised.

Keep children below the age of 8 years old at a safe distance from the appliance and power cable.

Always slide accessories into the cooking compartment the right way round.

→ "Accessories" on page 11

Important safety information

General information

Warning – Risk of fire!

- Combustible items stored in the cooking compartment may catch fire. Never store combustible items in the cooking compartment. Never open the appliance door if there is smoke inside. Switch off the appliance and unplug it from the mains or switch off the circuit breaker in the fuse box.
- Loose food remnants, fat and meat juices may catch fire. Before using the appliance, remove the worst of the food remnants from the cooking compartment, heating elements and accessories.
- A draught is created when the appliance door is opened. Greaseproof paper may come into contact with the heating element and catch fire. Do not place greaseproof paper loosely over accessories during preheating. Always weight down the greaseproof paper with a dish or a baking tin. Only cover the surface required with greaseproof paper. Greaseproof paper must not protrude over the accessories.

Warning – Risk of burns!

- The appliance becomes very hot. Never touch the interior surfaces of the cooking compartment or the heating elements. Always allow the appliance to cool down. Keep children at a safe distance.
- Accessories and ovenware become very hot. Always use oven gloves to remove accessories or ovenware from the cooking compartment.
- Alcoholic vapours may catch fire in the hot cooking compartment. Never prepare food containing large quantities of drinks with a high alcohol content. Only use small quantities of drinks with a high alcohol content. Open the appliance door with care.

Warning – Risk of scalding!

- The accessible parts become hot during operation. Never touch the hot parts. Keep children at a safe distance.
- When you open the appliance door, hot steam can escape. Steam may not be visible, depending on its temperature. When opening, do not stand too close to the appliance. Open the appliance door carefully. Keep children away.
- Water in a hot cooking compartment may create hot steam. Never pour water into the cooking compartment when the cooking compartment is hot.

Warning – Risk of injury!

- Scratched glass in the appliance door may develop into a crack. Do not use a glass scraper, sharp or abrasive cleaning aids or detergents.
- The hinges on the appliance door move when opening and closing the door, and you may be trapped. Keep your hands away from the hinges.
- Components inside the appliance door may have sharp edges. Wear protective gloves.

Warning – Risk of electric shock!

- Incorrect repairs are dangerous. Repairs may only be carried out and damaged power cables replaced by one of our trained after-sales technicians. If the appliance is defective, unplug the appliance from the mains or switch off the circuit breaker in the fuse box. Contact the after-sales service.
- The cable insulation on electrical appliances may melt when touching hot parts of the appliance. Never bring electrical appliance cables into contact with hot parts of the appliance.
- Do not use any high-pressure cleaners or steam cleaners, which can result in an electric shock.
- A defective appliance may cause electric shock. Never switch on a defective appliance. Unplug the appliance from the mains or switch off the circuit breaker in the fuse box. Contact the after-sales service.

⚠ Warning – Hazard due to magnetism!

Permanent magnets are used in the control panel or in the control elements. They may affect electronic implants, e.g. heart pacemakers or insulin pumps. Wearers of electronic implants must stay at least 10 cm away from the control panel.

Halogen lamp**⚠ Warning – Risk of burns!**

The bulbs in the cooking compartment become very hot. There is still a risk of burning your skin for some time after they have been switched off. Do not touch the glass cover. Avoid contact with your skin when cleaning.

⚠ Warning – Risk of electric shock!

When replacing the cooking compartment bulb, the bulb socket contacts are live. Before replacing the bulb, unplug the appliance from the mains or switch off the circuit breaker in the fuse box.

Steam**⚠ Warning – Risk of scalding!**

- The water in the water tank may become very hot if you continue to operate the appliance. Empty the water tank after every operation with steam.
- Hot steam is generated in the cooking compartment. Do not reach into the cooking compartment during any operation with steam.
- Hot liquid may spill over the sides of the accessory when it is removed from the cooking compartment. Remove hot accessories with care and always wear oven gloves.

⚠ Warning – Risk of injury and risk of fire!

Flammable liquids can catch fire in the cooking compartment when it is hot (explosion). Do not fill the water tank with any flammable fluids (e.g. alcoholic drinks). Only fill the water tank with water or with the descaling solution that is recommended by us.

➔ Causes of damage**General information****Caution!**

- Accessories, foil, greaseproof paper or ovenware on the cooking compartment floor: do not place accessories on the cooking compartment floor. Do not cover the cooking compartment floor with any sort of foil or greaseproof paper. Do not place ovenware on the cooking compartment floor if a temperature of over 50 °C has been set. This will cause heat to accumulate. The baking and roasting times will no longer be correct and the enamel will be damaged.
- Aluminium foil: Aluminium foil in the cooking compartment must not come into contact with the door glass. This could cause permanent discolouration of the door glass.
- Water in a hot cooking compartment: do not pour water into the cooking compartment when it is hot. This will cause steam. The temperature change can cause damage to the enamel.
- Moisture in the cooking compartment: Over an extended period of time, moisture in the cooking compartment may lead to corrosion. Allow the cooking compartment to dry after use. Do not keep moist food in the closed cooking compartment for extended periods of time. Do not store food in the cooking compartment.
- Cooling with the appliance door open: Following operation at high temperatures, only allow the cooking compartment to cool down with the door closed. Do not trap anything in the appliance door. Even if the door is only left open a crack, the front of nearby furniture may become damaged over time. Only leave the cooking compartment to dry with the door open if a lot of moisture was produced whilst the oven was operating.
- Fruit juice: when baking particularly juicy fruit pies, do not pack the baking tray too generously. Fruit juice dripping from the baking tray leaves stains that cannot be removed. If possible, use the deeper universal pan.
- Extremely dirty seal: If the seal is very dirty, the appliance door will no longer close properly during operation. The fronts of adjacent units could be damaged. Always keep the seal clean. Never operate the appliance if the seal is damaged or missing.
- Appliance door as a seat, shelf or worktop: Do not sit on the appliance door, or place or hang anything on it. Do not place any cookware or accessories on the appliance door.
- Inserting accessories: depending on the appliance model, accessories can scratch the door panel when closing the appliance door. Always insert the accessories into the cooking compartment as far as they will go.
- Carrying the appliance: do not carry or hold the appliance by the door handle. The door handle cannot support the weight of the appliance and could break.

Steam

Caution!

- Baking tins: Ovenware must be heat and steam resistant. Silicone baking tins are not suitable for combined operation with steam.
- Ovenware with areas of rust: Do not use any ovenware which displays areas of rust. Even the smallest spots of rust can lead to corrosion in the cooking compartment.
- Hot water in the water tank: Hot water may damage the steam system. Only fill the water tank with cold water.
- Enamel damage: Do not start any operations when there is water on the cooking compartment floor. Before operation, wipe away the water from the cooking compartment floor.
- Descaling solution: Do not allow any descaling solution to come into contact with the control panel or other surfaces on the appliance. This damages the surfaces. If this does happen, remove the descaling solution immediately with water.
- Cleaning the water tank: Do not clean the water tank in the dishwasher. Otherwise, the water tank will be damaged. Clean the water tank with a soft cloth and standard washing-up liquid.

Environmental protection

Your new appliance is particularly energy-efficient. Here you can find tips on how to save even more energy when using the appliance, and how to dispose of your appliance properly.

Saving energy

- Only preheat the appliance if this is specified in the recipe or in the tables in the operating instructions.
- Leave frozen food to defrost before placing it in the cooking compartment.

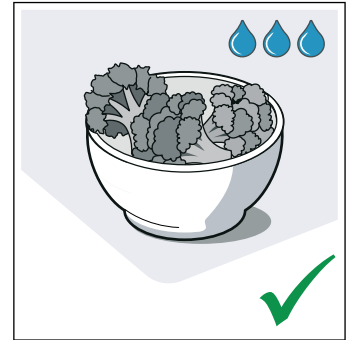
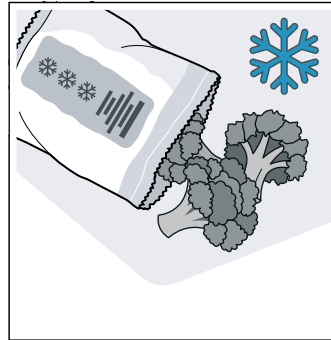

- Use baking tins that are dark-coloured, painted black or have an enamel coating. These absorb the heat particularly well.

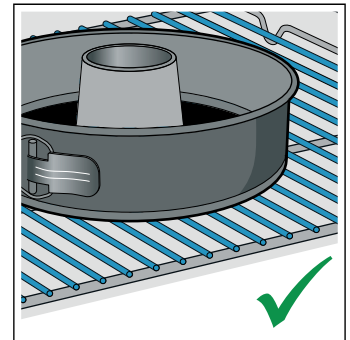
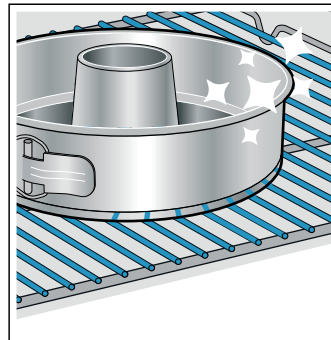

- Remove any unnecessary accessories from the cooking compartment.

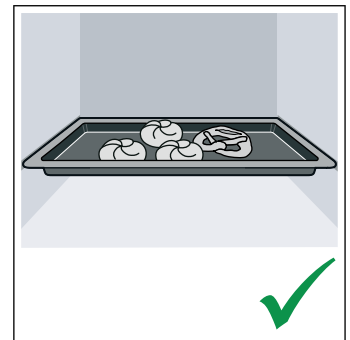
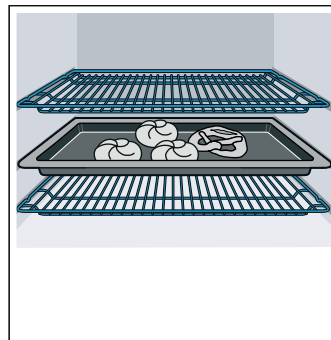

en Environmental protection

- Open the appliance door as infrequently as possible when the appliance is in use.

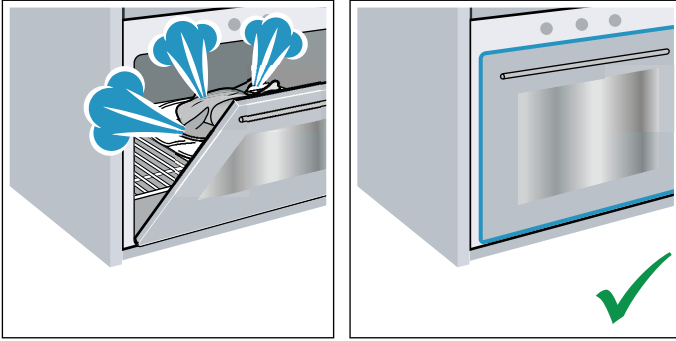

- It is best to bake several cakes one after the other. The cooking compartment stays warm. This reduces the baking time for the second cake. You can place two cake tins next to each other in the cooking compartment.

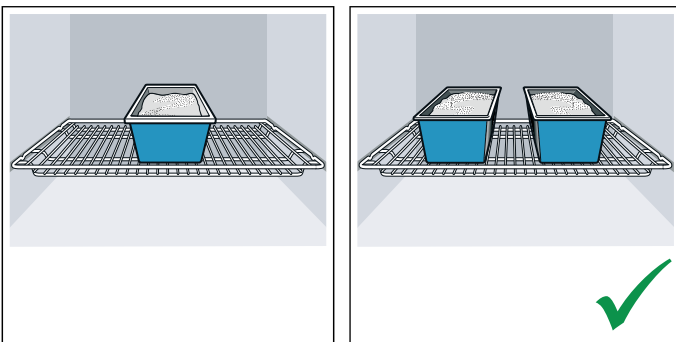

- For longer cooking times, you can switch the appliance off 10 minutes before the end of the cooking time and use the residual heat to finish cooking.

Environmentally-friendly disposal

Dispose of packaging in an environmentally-friendly manner.



This appliance is labelled in accordance with European Directive 2012/19/EU concerning used electrical and electronic appliances (waste electrical and electronic equipment - WEEE). The guideline determines the framework for the return and recycling of used appliances as applicable throughout the EU.

Getting to know your appliance

In this section, we will explain the indicators and controls. You will also find out about the various functions of your appliance.

Note: Depending on the appliance model, individual details and colours may differ.

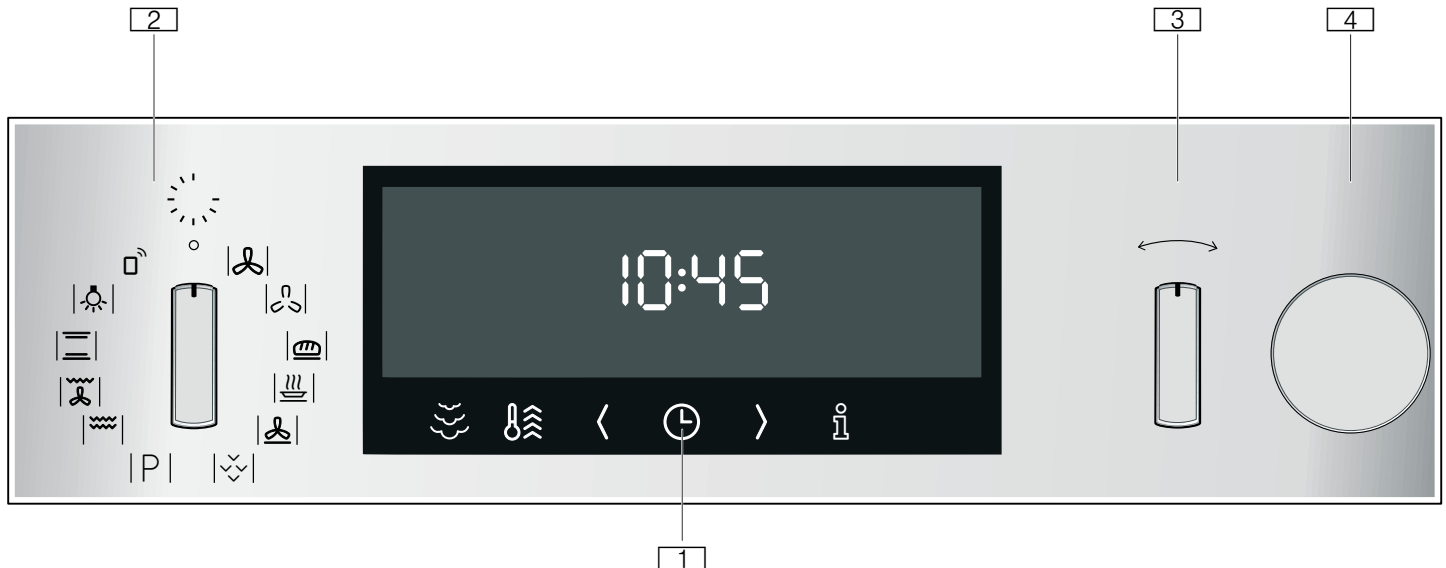

1 Buttons and display

The buttons are touch keys with sensors underneath. Simply touch a symbol to select the function.

The display shows symbols for active functions and the time-setting options.

2 Function selector

Use the function selector to set the heating function or other functions.

You can turn the function selector clockwise or anti-clockwise from the "Off" position.

3 Temperature selector

Use the temperature selector to set the temperature for the heating function or select the setting for other functions.

You can also turn the temperature selector clockwise or anti-clockwise. It does not have an "Off" position.

4 Water tank

Filling and emptying the water tank → *"Filling the water tank" on page 15*







Note: On some appliances, the control knobs can be pushed in. To push the control knob in and engage it or to release it again, turn it to the "Off" position.

Control panel

You can set your appliance's various functions on the control panel. Below, you will see an overview of the control panel and the layout of the controls.

Buttons and display

You can use the buttons to set various additional functions on your appliance. You will be able to see the values for these on the display.

Symbol	Meaning	
Buttons		
	Time-setting options	Tap the symbol repeatedly to select the time ⌚, timer ⌚, duration → and end time → .
<	Minus	Reduce setting values.
>	Plus	Increase setting values.
	Steam-assisted cooking	Switching on steam-assisted cooking
	Rapid heating	Starts or cancels rapid heating for the cooking compartment.
	Information	Displays current temperature in the cooking compartment.
	Basic settings	Basic settings e.g. activate child safety lock.
Display		
	* Empty water tank	Prompt to empty the water tank
	* Fill water tank	Prompt to fill the water tank
	* Descale	Descal the appliance
* Symbol appears on the display, depending on the situation		

Display

The cooking compartment temperature you set using the temperature selector will be shown on the display.









In addition, you can read the settings for the time-setting options. The value that can be set at the present time or that is elapsing will be shown in large digits on the display. To use the individual time-setting options, touch

the  button several times. If there is a red bar above or below a symbol, this means that the value being shown in large digits on the display refers to the function that this symbol represents.

Types of heating and functions

Use the function selector to set the types of heating and other functions.





To make sure you always use the right type of heating to cook your food, we have explained the differences and applications below.

Type of heating	Temperature	Use
 CircoTherm hot air*	30 - 200 °C	For baking and cooking on one or more levels. The fan distributes the heat from the ring-shaped heating element in the back panel evenly around the cooking compartment.
 CircoTherm gentle	125-200 °C	For gently cooking selected types of food on one level without preheating. The fan distributes the heat from the ring-shaped heating element in the back panel around the cooking compartment. This heating function is used to measure both the energy consumption in air recirculation mode and the energy efficiency class.
 Bread-baking setting*	180 - 240 °C	For baking bread, bread rolls and baked goods that require high temperatures.
 Reheating**	80 - 180 °C	For gently reheating food or for crisping up baked goods.
 Pizza setting	30 - 275 °C	For cooking pizza and dishes that require a lot of heat from underneath. The bottom heating element and the ring-shaped heating element in the back panel heat the cooking compartment.
 Grill, large area	30 - 275 °C	For grilling flat items, such as steaks or sausages, for making toast, and for browning food. The whole area below the grill element becomes hot.
Grill, intensive	from 275 °C: <i>int</i>	
 Circo-roasting*	30 - 250 °C	For roasting poultry, whole fish and larger pieces of meat. The grill element and the fan switch on and off alternately. The fan circulates the hot air around the food.
 Top/bottom heating*	30 - 275 °C	For traditional baking and roasting on one level. Especially suitable for cakes with moist toppings. Heat is emitted evenly from above and below. This type of heating is used to measure the energy consumption in the conventional mode.
* Steam assistance possible with this type of heating from 80 °C and over (water tank must be full before appliance is operated)		
** Steam heating function (water tank must be full before appliance is operated)		

Note: For each heating function, the appliance specifies a default temperature or level. You can accept this value or change it in the appropriate area.

Other functions

Your new oven has yet more functions; see below for a brief description of these.

Function	Use
 Interior lighting	Switches on the interior lighting; all other functions remain off. Makes it easier to clean the cooking compartment, for example.
 Remote start	Start and operate the appliance via the Home Connect app. → "Home Connect" on page 22
 Descaling	Descaling  your appliance keeps it working properly. → "Cleaning function" on page 25
 Programs	For many types of food, the appliance has preprogrammed setting values that you can use. → "Programmes" on page 20

Temperature

Use the temperature selector to set the temperature in the cooking compartment. It can also be used to select the grill and cleaning settings, for example.

The settings appear in the display.

Notes

- The temperature can be set in 1-degree increments up to 100 °C, and in 5-degree increments thereafter.
- For temperature settings above 275 °C for the Grill type of heating, the appliance reduces the temperature to approx. 250 °C after approx. 20 minutes.

Cooking compartment

Various functions in the cooking compartment make your appliance easier to use. For example, the cooking compartment is well lit and a cooling fan prevents the appliance from overheating.

Opening the appliance door

If you open the appliance door when the appliance is in operation, the appliance will continue to operate as before.

Interior lighting

With most heating functions and other functions, the interior lighting in the cooking compartment will remain lit while the oven is in operation. When the function selector is turned to bring operation to an end, the lighting will go out.

By turning the function selector to the interior lighting setting, you can switch on the lighting without heating the oven. This makes it easier to clean your appliance, for example.

Cooling fan

The cooling fan switches on and off as required. The hot air escapes above the door.

Caution!

Do not cover the ventilation slots. Otherwise, the appliance may overheat.

So that the cooking compartment cools down more quickly after operation, the cooling fan continues to run for a certain period afterwards.

Accessories

Your appliance is accompanied by a range of accessories. Here, you can find an overview of the accessories included and information on how to use them correctly.

Control accessories

The accessories supplied may differ depending on the appliance model.



Only use original accessories. They are specially adapted for your appliance.

You can buy accessories from the after-sales service, from specialist retailers or online.

Note: The accessories may deform when they become hot. This does not affect their function. Once they have cooled down again, they regain their original shape.

Inserting accessories

The cooking compartment has four shelf positions. The shelf positions are counted from the bottom up.

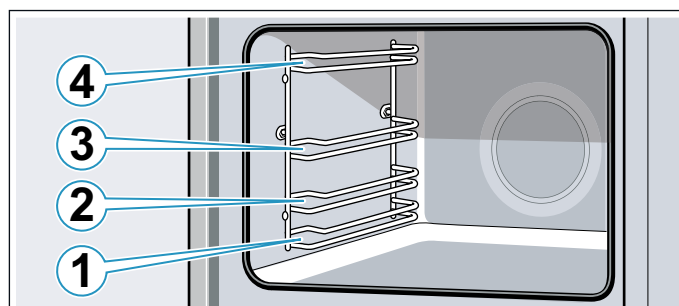

Always insert accessories between the two guide rods for the shelf position.

Accessories can be pulled out approximately halfway without tipping.

Notes

- Make sure that you always insert the accessories into the cooking compartment the right way round.
- Always insert the accessories fully into the cooking compartment so that they do not touch the appliance door.
- Take any accessories that you will not be using out of the cooking compartment.
- The shelves can be taken out of the cooking compartment for cleaning. → Page 26

Locking function

The accessories can be pulled out approximately halfway until they lock in place. The locking function prevents the accessories from tilting when they are pulled out. The accessories must be inserted into the cooking compartment correctly for the tilt protection to work properly.

When inserting the wire rack, ensure that lug **a** is at the rear and is facing downwards. The open side must be facing the appliance door and the outer rail must be facing downwards .

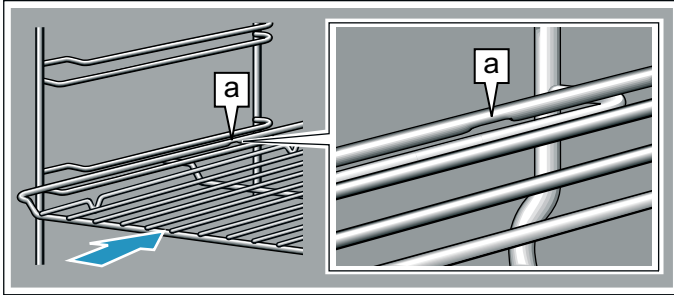

When inserting baking trays, make sure that the recess **a** is at the rear and is facing downwards. The sloping edge of the accessory **b** must be facing towards the appliance door.

Example in the picture: Universal pan

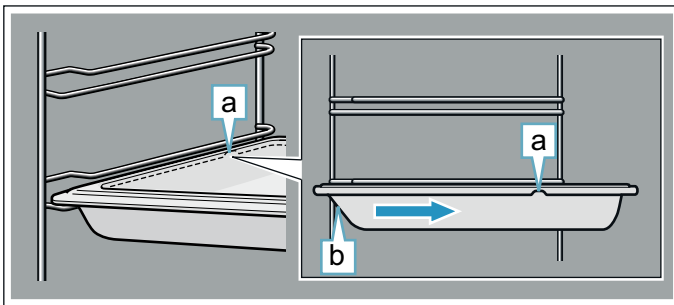

Combining accessories

You can insert the wire rack and the universal pan at the same time to catch drops of liquid.

When inserting the wire rack, ensure that both spacers **a** are at the rear edge. When inserting the universal pan, the wire rack is on top of the upper guide rod of the shelf position.

Example in the picture: Universal pan

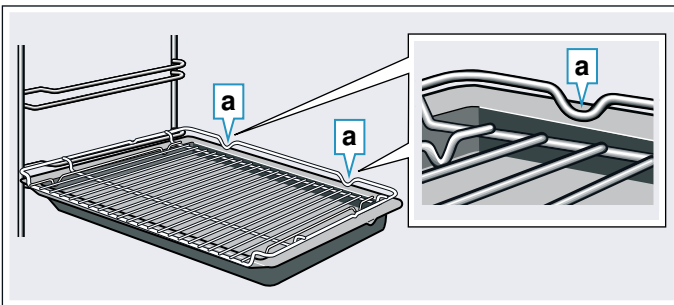

Optional accessories

You can purchase optional accessories from the after-sales service and specialist retailers, or on the Internet. You will find a comprehensive range of products for your appliance in our brochures and on the Internet.

Both availability and whether it is possible to order online differ between countries. Please see your sales documents for more details.

Note: Not all optional accessories are suitable for every appliance. When purchasing, please always quote the exact designation (E no.) of your appliance.

→ "Customer service" on page 32

Accessories
Baking and roasting shelf
Baking tray
Universal pan
Baking tray, non-stick
Universal pan, non-stick
Extra-deep pan
Steaming set for ovens
Profi pan
Lid for the Profi pan
Pizza tray
Grill tray
Ceramic brick
Glass roasting dish, 5.1 litres
Glass pan
ComfortFlex rail (1 level)*
3 x fully extendable pull-out rack*
*Accessory does not fit in every appliance, quote the E no. when ordering

Before using for the first time

Before you can use your new appliance, you must make some settings. You must also clean the cooking compartment and accessories.

Before using for the first time

Before using the appliance for the first time, ask your water supplier about the hardness of your tap water.

Caution!

- Damage to the appliance caused by the water hardness being set incorrectly. The appliance cannot remind you to descale it at the right time. Ensure that the water hardness is set correctly.
- Using unsuitable liquids may damage the appliance. Do not use distilled water, highly chlorinated tap water (>40 mg/l) or other liquids. Only use cold, fresh tap water, softened water or non-carbonated mineral water.

Notes

- If your water is very hard, we recommend that you use softened water.
- If you only use softened water, you can set the water hardness range to "softened".
- If you use mineral water, set the water hardness range to "very hard".
- If you use mineral water, you must only use non-carbonated mineral water.

Initial use



As soon as the appliance is connected to the power supply, **12:00** flashes in the display.

Setting the time

Use the < or > buttons to set the current time.

After a few seconds, the time that has been set is adopted.

Changing the time

1. Press the  button repeatedly until the  symbol lights up.
2. Use the < or > button to change the time. After a few seconds, the time that has been set is adopted.

Setting the water hardness

Set the water hardness in the basic settings. → "Basic settings" on page 19

Setting	Water hardness range		
	mmol/l	German (°dH)	French (°fH)
c 110 = softened	-	-	-
c 111 = soft	Up to 1.3	Up to 7.3	Up to 13
c 112 = medium	1.3–2.5	7.3–14	13–25
c 113 = hard	2.5–3.8	14–21.3	25–38
c 114 = very hard	Above 3.8	Above 21.3	Above 38

Cleaning the cooking compartment

To eliminate the new-appliance smell, heat up the cooking compartment without anything in it and with the oven door closed.

1. Remove the accessories from the cooking compartment.
2. Remove any leftover packaging, such as polystyrene pellets, from the cooking compartment.
3. Before heating the appliance, wipe the smooth surfaces in the cooking compartment with a soft, damp cloth.
4. Fill the water tank. → "Filling the water tank" on page 15
5. Set the specified type of heating and temperature for steam-assisted heating. → "Operating the appliance" on page 14 → "Steam" on page 15

Steam-assisted heating

Type of heating	CircoTherm  steam-assisted programme high
Temperature	200 °C
Cooking time	30 minutes

6. After heating up the appliance with steam assistance, heat it without steam assistance.
7. Set the specified type of heating and temperature for heating without steam assistance.

Heating without steam assistance

Type of heating	Top/bottom heating 
Temperature	240 °C
Cooking time	30 minutes

8. Keep the kitchen ventilated while the appliance is heating.
9. Switch off the appliance after the specified cooking time.
10. Wait until the cooking compartment has cooled down.
11. Clean the smooth surfaces with soapy water and a dish cloth.
12. Empty the water tank and dry the cooking compartment. → "After every steam operation" on page 16

Cleaning the accessories

Clean the accessories thoroughly using soapy water and a dish cloth or soft brush.

Operating the appliance

You have already learnt about the controls and how they work. Now we will explain how to apply settings on your appliance.

Switching the appliance on and off

Use the function selector to switch the appliance on or off. Turning the function selector to any position other than the "Off" position switches on the appliance. To switch off the appliance, always turn the function selector to the "Off" position.

Setting the type of heating and temperature

It is very easy to use the function and temperature selector to make settings for your appliance. To find out which type of heating is best for which type of food, refer to the beginning of the instruction manual. → "Getting to know your appliance" on page 9

Example in the picture: CircoTherm Hot Air  at 160 °C.

1. Use the function selector to set the type of heating.

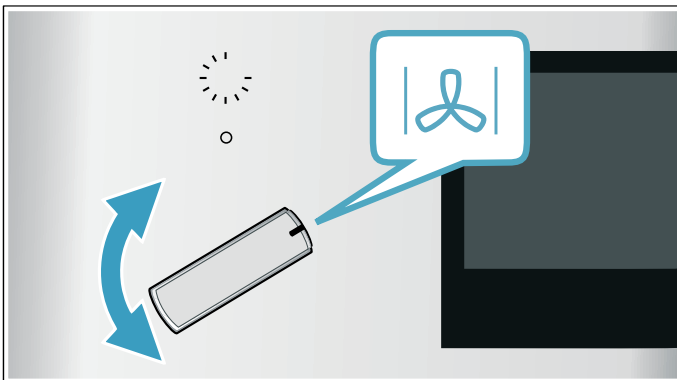

2. Use the temperature selector to set the temperature or grill setting.

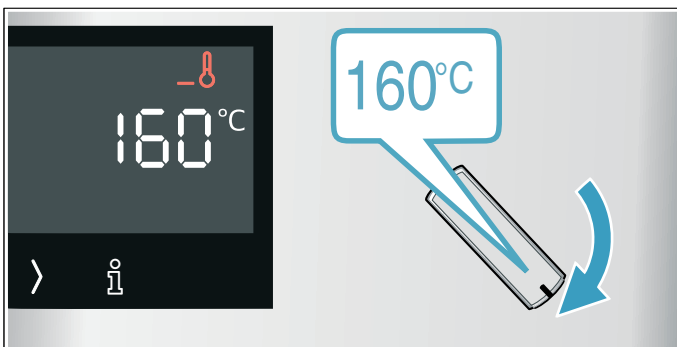

The appliance starts to heat up after a few seconds.

Note: If **h** flashes in the display, the temperature in the cooking compartment is too high for the selected operating mode. Switch the appliance off, wait until it has cooled down and then switch it back on again.

Once your food is cooked, turn the function selector to the "Off" position to switch the appliance off.

Note: You can set both a cooking time and an end time on the appliance. → "Time-setting options" on page 17

Changing

The heating function and temperature can be changed at any time using the relevant selector.

If you change the heating function, the temperature will be changed to the corresponding default value.

Temperature display

As soon as the appliance heats up, the  symbol appears in the display. The lines are filled from the bottom to the top as the cooking compartment heats up.

When you are preheating the appliance, the optimal time to place your food in the cooking compartment is when the  symbol first goes out.

- Appliance heats up (fig. 1)
- Temperature has been reached (fig. 2)

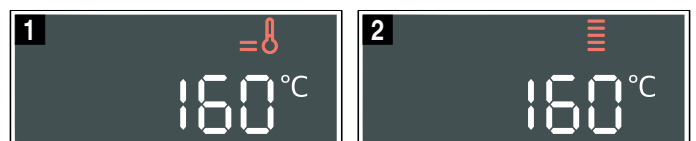

Residual heat

When the appliance is switched off, the temperature indicator shows the residual heat in the cooking compartment. The lower the temperature drops, the less the indicator is filled.



Notes

- The temperature indicator only shows the increasing temperature for types of heating for which a temperature is set. With cleaning functions, for example, it is filled immediately.
- Due to thermal inertia, the temperature displayed may be slightly different to the actual temperature inside the cooking compartment.

Rapid heating

With Rapid heating, you can shorten the heat-up time.



Suitable heating functions include:

-  CircoTherm hot air
-  Bread-baking setting
-  Top/bottom heating

Only use rapid heating when a temperature of over 100 °C has been selected.

To achieve an even cooking result, do not place your food into the cooking compartment until rapid heating is complete.

1. Set the type of heating and temperature.
2. Touch the  button.

The  symbol appears in the display, and the  arrows are filled from the bottom to the top.

The oven starts to heat up after a few seconds.

Once rapid heating is complete, an audible signal sounds and the  symbol goes out. Place your food in the cooking compartment.

Steam

Cook food with steam assistance.

Warning – Risk of scalding!

When you open the appliance door, hot steam can escape. Steam may not be visible, depending on its temperature. When opening, do not stand too close to the appliance. Open the appliance door carefully. Keep children away.

Warning – Risk of scalding!

The water tank may heat up while the appliance is in operation. Allow the water tank to cool down before emptying it.

Steam-assisted cooking

When you cook with steam assistance, steam is introduced into the cooking compartment at various intervals and with varying degrees of intensity. This gives you a better cooking result.

Your food

- Becomes crispy on the outside
- Develops a glossy surface
- Is succulent and tender on the inside
- Only undergoes a minimal reduction in volume

Use the settings in the tables. → "Tested for you in our cooking studio" on page 33 → "Programmes" on page 20





Steam intensity

Different intensity levels are available for steam-assisted cooking:

- low = **low**
- high = **high**

Suitable heating functions

You can switch on steam assistance for the following heating functions:

- CircoTherm hot air 
- Top/bottom heating 
- Circo-roasting 
- Bread-baking setting 

Starting

1. Fill the water tank.
2. Set the type of heating and temperature.
Note: When you cook with steam, the appliance can be set to between 80 and 240 °C.
3. Touch the  button to switch on the steam intensity you require.

The appliance starts.

Cancelling steam addition

To switch off the added steam function early, touch the  button repeatedly until the steam intensity has been deactivated.

Note: The appliance will continue to operate, but steam will not be injected into the cooking compartment.

Finishing

To switch off the appliance, turn the function selector to the "Off" position. → "After every steam operation" on page 16

Reheating

With the "Reheat" heating function , you can gently reheat food that has already been cooked or crisp up day-old baked goods. The added steam function is activated automatically.

Starting

1. Wait until the cooking compartment has cooled down.
2. Fill the water tank.
3. Use the function selector to set "Reheating ".
4. Use the temperature selector to set the temperature. The appliance starts.

Finishing

To switch off the appliance, turn the function selector to the "Off" position. → "After every steam operation" on page 16

Filling the water tank

Make that you have set the correct water hardness range. → "Basic settings" on page 19

Warning – Risk of injury and risk of fire!

Only fill the water tank with water or with the descaling solution that is recommended by us. Do not pour any flammable liquids (e.g. alcoholic drinks) into the water tank. Due to hot surfaces, vapours from flammable liquids may catch fire in the cooking compartment (explosion). The appliance door may spring open. Hot steam and jets of flame may escape.

Warning – Risk of burns!

The water tank may heat up while the appliance is in operation. Wait until the water tank has cooled down after the previous appliance operation. Remove the water tank from the water tank recess.

Caution!

The appliance may become damaged due to the use of unsuitable liquids.

Do not use distilled water, highly chlorinated tap water (> 40 mg/l) or other liquids.

Only use cold, fresh tap water, softened water or uncarbonated mineral water.

Notes

- If your water is very hard, we recommend that you use softened water.
- If you only use softened water, you can set the water hardness range to "softened".
- If you use mineral water, set the water hardness range to "very hard".
- If you use mineral water, you must only use non-carbonated mineral water.

1. Press on the water tank (Fig. 1).
2. Pull out the water tank (Fig. 2).

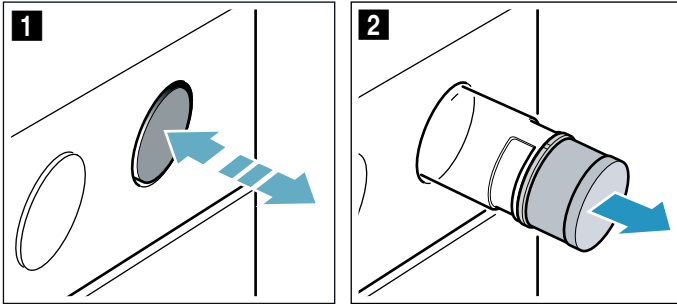

3. Press the lid of the water tank down and unscrew it (Fig. 3).
4. Fill with water (Fig. 4).

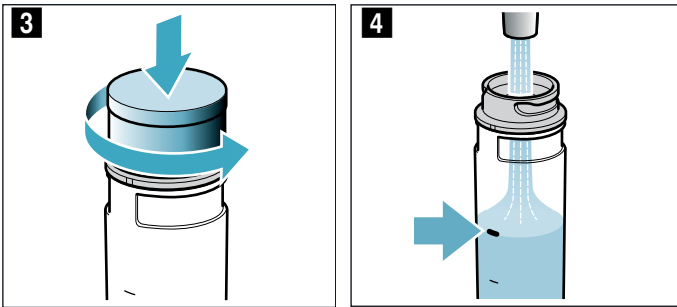

5. Screw the lid of the water tank closed (Fig. 5).

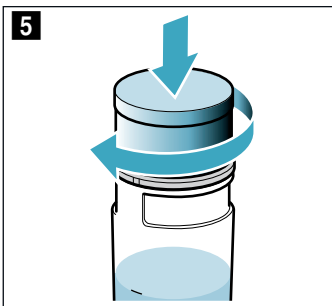

6. Place the water tank back in the opening and press it down until it clicks into place (Fig. 6).

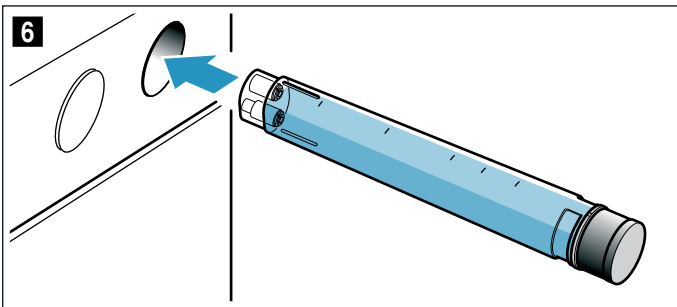

Refilling the water tank

If the water tank is empty, an audible signal sounds and the "Fill water tank" symbol appears on the display. → "Getting to know your appliance" on page 9

1. Remove and refill the water tank.
2. Insert the full water tank.

Note: If you do not refill the water tank, operation continues without steam-assisted cooking.

After every steam operation

Warning – Risk of scalding!

When you open the appliance door, hot steam can escape. Steam may not be visible, depending on its temperature. When opening, do not stand too close to the appliance. Open the appliance door carefully. Keep children away.

Warning – Risk of burns!

The appliance becomes hot during operation. Allow the appliance to cool down before cleaning.

Warning – Risk of scalding!

The water tank may heat up while the appliance is in operation. Allow the water tank to cool down before emptying it.

Caution!

Enamel damage: Do not start any operations when there is water on the cooking compartment floor. Before operation, wipe away the water from the cooking compartment floor.

The remaining water is pumped back into the water tank after every operation with steam. Then empty and dry the water tank. Moisture remains in the cooking compartment. Dry the cooking compartment.

Note: Remove limescale marks with a cloth soaked in vinegar, then rinse with clean water and dry with a soft cloth.

Emptying the water tank

Caution!

- Do not dry the water tank in the hot cooking compartment. This will damage the water tank.
- Do not clean the water tank in the dishwasher. This will damage the water tank.





1. Press on the water tank.
2. Pull out the water tank.
3. Unscrew the lid on the water tank.
4. Empty the water tank, clean it with detergent and then rinse it thoroughly with clean water.
5. Dry all parts with a soft cloth.
6. Rub the seal on the lid until dry.
7. Leave the water tank to dry with the lid off.
8. Place the lid on the water tank and screw it on.
9. Put the water tank in.

Drying the cooking compartment by hand

1. Allow the appliance to cool down.
2. Remove any food remnants from the walls of the cooking compartment.
3. Dry the cooking compartment with a sponge.
4. Leave the appliance door open for 1 hour so that the cooking compartment dries completely.

Time-setting options

Your appliance has different time-setting options.

Time-setting option	Use
 Timer	The timer functions like an egg timer. It runs independently of the appliance when it is heating and of other time-setting options, and does not affect the appliance.
 Cooking time	Once the set cooking time has elapsed, the appliance automatically stops heating.
 End time	Enter a cooking time and the required end time. The appliance starts up automatically so that it finishes cooking at the required time.
 Time	Set the time, e.g. after a power cut, or change it, e.g. from summer time to winter time.

An audible signal sounds once the cooking time or timer duration has elapsed. You can cancel the audible signal early by pressing the  button.







Note: You can change how long the audible signal sounds for in the basic settings. → *"Basic settings"* on page 19

Note: If you have set a time-setting option, the time interval increases if you set a higher value. Example: You can set a cooking time of up to one hour in one-minute increments; for cooking times over one hour, you can set a cooking time in five-minute increments.

Setting the timer

The timer can be set when the appliance is switched on or off. It has its own audible signal so that you can tell whether it is the timer duration or a cooking time that has elapsed.

Tip: If the set timer duration is the duration for which you want to cook your food, use the cooking time. The appliance then switches off automatically.

1. Press the  button repeatedly until the  symbol is selected.
2. Use the  and  buttons to set the timer duration.
 - Default value for the  button = 5 minutes
 - Default value for the  button = 10 minutes









The setting is applied automatically. The timer duration starts to count down after a few seconds.

Note: When the set time has elapsed, a signal sounds. To end the timer, press the  button.

Setting the cooking time

Once the set cooking time has elapsed, the appliance switches off automatically. The function can only be used in combination with a type of heating.

1. Set the type of heating and temperature.
2. Press the  button repeatedly until the  symbol is selected.
3. Use the  and  buttons to set the cooking time.
 - Default value for the  button = 10 minutes
 - Default value for the  button = 30 minutes
 The setting is applied automatically. The appliance starts heating after a few seconds. The duration counts down in the display.









Once the cooking time has elapsed, an audible signal sounds and the appliance brings the operating mode to an end automatically.

To switch off, turn the function selector back to the "Off" position.

Setting the end time

You can delay the time at which cooking is due to finish. You can, for example, put your food in the cooking compartment in the morning and set the cooking time so that it is ready at lunch time.

Notes





- Ensure that food is not left in the cooking compartment for too long as it may spoil.
 - Do not adjust the end time once the appliance is already in operation. Otherwise the cooking result would no longer be satisfactory.
1. Place the food onto the appropriate accessory in the cooking compartment and close the appliance door.
 2. Set the type of heating and temperature.
 3. Press the  button repeatedly until the  symbol is selected.
 4. Use the  and  buttons to set the cooking time.
 5. Press the  button repeatedly until the  symbol is selected.
 6. Use the  and  buttons to set the end time. The appliance applies the settings after a few seconds. The end time is shown in the display. Once the appliance starts, the time begins counting down.

As soon as the end time has been reached, an audible signal sounds and the appliance ends the operation automatically.

To switch off, turn the function selector back to the "Off" position.



Setting the time

You can only change the time when no other time-setting option is active and the function selector is at the "Off" position.

1. Press the  button repeatedly until the  symbol is selected.
2. Use the  or  button to change the time.
The appliance applies the time after a few seconds.

Note: You can go to the basic settings to specify whether or not the time should be shown in the display.

Checking, changing or deleting settings

1. Press the  button repeatedly until the appropriate symbol is selected.
2. If required, use the  or  button to change the setting. To delete a time-setting option, set **00:00**.
The setting is applied automatically.

Childproof lock

Your appliance is equipped with a childproof lock so that children cannot switch it on accidentally or change any settings.



Notes

- You can go to the basic settings to specify whether you want the option to set the childproof lock.
→ "Basic settings" on page 19
- If a hob is connected, it will not be affected by the childproof lock on the oven.

Automatic childproof lock



The control panel is locked so that the appliance cannot be switched on. To switch it on, the automatic childproof lock must be interrupted. After the appliance operation, the control panel is locked automatically.

To set or interrupt the automatic childproof lock, the function selector must be in the "Off" position.

1. Press and hold the  button for approx. four seconds.
000 0 or **000 1** appears in the display.
2. Use the temperature selector to change the setting as required.
 - **0** = deactivate
 - **1** = activate
3. When you have finished, press and hold the  button again for approx. four seconds to confirm the settings.

The basic setting is applied.

Cancelling

1. Press and hold the  button until the  symbol goes out in the display.
2. Set the type of heating and temperature.



As soon as the appliance is switched off, the automatic childproof lock is reactivated.

One-time childproof lock



The control panel is locked so that the appliance cannot be switched on. To switch it on, the one-time childproof lock must be deactivated. After the appliance is switched off, the control panel is no longer locked.

To set, activate or deactivate the one-time childproof lock, the function selector must be at the "Off" position.

Activating

Press and hold the  button until the  symbol appears in the display.

Deactivating

Press and hold the  button until the  symbol goes out in the display.

Basic settings

There are various settings available to you in order to help use your appliance effectively and simply. You can change these settings as required.

List of basic settings

Depending on the features of your appliance, not all basic settings will be available.

Basic setting	Options
c00 Automatic childproof lock	0 = no* 1 = yes
c01 Audible signal duration upon completion of a cooking time or timer duration	1 = approx. 10 seconds 2 = approx. 30 seconds* 3 = approx. 2 minutes
c02 Amount of time until a setting is applied	1 = approx. 3 seconds* 2 = approx. 6 seconds 3 = approx. 10 seconds
c03 Button tone that sounds when a button is touched	0 = off 1 = on*
c04 Brightness of the display illumination	1 = dark 2 = medium* 3 = bright
c05 Display time of day	0 = hide the time 1 = display the time*
c06 Enable childproof lock activation?	0 = no 1 = yes* 2 = yes, with locked door**
c07 Interior lighting on when appliance in operation?	0 = no 1 = yes*
c08 Cooling fan run-on time	1 = short 2 = medium* 3 = long 4 = extra long
c09 Telescopic rails retrofitted?*	0 = no* (for rails and single pull-out system) 1 = yes (for double and triple pull-out systems)
c10 Sabbath mode available?	0 = no* 1 = yes
c11 Water hardness**	0 = softened 1 = soft (up to 1.3 mmol/l) 2 = medium (1.3 - 2.5 mmol/l) 3 = hard (2.5 - 3.8 mmol/l) 4 = very hard* (above 3.8 mmol/l)
c12 Reset all values to factory settings?	0 = no* 1 = yes

* Factory setting (factory settings may vary depending on the appliance model)



** Not available for all appliance types.

Note: If your appliance is equipped with the Home Connect function, you will find the Home Connect settings at the end of the basic settings for your appliance. → Page 22

The Home Connect settings begin with HC.

Changing the basic settings

The function selector must be set to the "Off" position.

1. Press and hold the  button for approx. four seconds.
The first basic setting appears in the display, e.g. c00 0.
2. Use the temperature selector to change the setting as required.
3. Use the > or < button to continue going through all the basic settings, and use the temperature selector if you want to change any of these settings.
4. When you have finished, press and hold the  button again for approx. four seconds to confirm the settings.

This applies all of the basic settings.

You can change the basic settings again at any time.

Programmes

You can prepare food very easily using the various programmes. Simply select a programme and the appliance will apply the optimal settings for you.

To achieve good results, the cooking compartment must not be too hot. Allow the cooking compartment to cool before starting the programme.

Information on the settings

- The cooking result depends on the quality of the food and the type of cookware. For an optimal cooking result, only use food that is fresh and in good condition and meat that is chilled to refrigerator temperature. For frozen food, only use food straight out of the freezer.
- For all food, you are asked to enter the weight. The appliance then applies the time and temperature settings for you.
It is not possible to set weights outside the preprogrammed weight range.

- It is therefore important that you use heat-resistant cookware.
- Information on the right kind of cookware to use and tips and tricks for preparing your food can be found at the end of the instruction manual.

Steam

For the steam programme, the appliance provides you with programmes you can use to prepare your meals easily and professionally.

Information about the steam functions can be found in the relevant sections. → "Steam" on page 15

Warning – Risk of scalding!

When you open the appliance door, hot steam can escape. Steam may not be visible, depending on its temperature. When opening, do not stand too close to the appliance. Open the appliance door carefully. Keep children away.

Selecting a dish

The following table shows the corresponding setting values for the listed dishes.

Programme	Food	Cookware	Weight range	Shelf position	Set weight	Information
<i>P1</i> Plaited loaf, savarin	-	Baking tray with greaseproof paper	0.6–1.5 kg	3	Dough weight	The cooking compartment must be cold to begin with.
<i>P2</i> Proving dough	Yeast dough	Bowl on wire rack	0.5–1.5 kg	2	Dough weight	The cooking compartment must be cold to begin with.
<i>P3</i> Wheat bread, multi-grain wheat bread on a baking tray*	-	Baking tray with greaseproof paper	0.5–2.0 kg	2	Dough weight	The cooking compartment must be cold to begin with.
<i>P4</i> Wheat bread, multi-grain wheat bread in a loaf tin	-	Cake tin, greased and floured	0.8–2.0 kg	2	Dough weight	The cooking compartment must be cold to begin with.
<i>P5</i> White bread on a baking tray	-	Baking tray with greaseproof paper	0.5–2.0 kg	2	Dough weight	If you are baking two loaves at the same time, enter the weight of the heavier bread
<i>P6</i> Multi-grain rye bread	-	Cake tin, greased and floured	0.8–2.0 kg	2	Dough weight	The cooking compartment must be cold to begin with.
<i>P7</i> Flatbread	-	Baking tray with greaseproof paper	0.4–1.0 kg	2	Dough weight	The cooking compartment must be cold to begin with.
<i>P8</i> Chicken, not stuffed	Ready to cook, seasoned	Roasting dish without lid or universal pan	0.9–1.5 kg	2	Chicken weight	Place in the cookware with the breast at the top.
<i>P9</i> Chicken pieces	Ready to cook, seasoned	Roasting dish without lid or universal pan	0.1–0.8 kg	3	Weight of the heaviest piece	-
<i>P10</i> Duck, unstuffed	Ready to cook, seasoned	Roasting dish without lid or universal pan	1.3–2.5 kg	2	Duck weight	Place in the cookware with the breast at the top.
<i>P11</i> Goose, unstuffed	Ready to cook, seasoned	Roasting dish without lid or universal pan	2.3–4.5 kg	2	Goose weight	Place in the cookware with the breast at the top.

Programme	Food	Cookware	Weight range	Shelf position	Set weight	Information	
P 12	Fillet of beef , medium	Ready to cook, seasoned	Roasting dish without lid or universal pan	0.8–2.0 kg	2	Meat weight	The meat does not need to be seared beforehand.
P 13	Fish , whole	Ready to cook, seasoned	Roasting dish without lid or universal pan	0.8–1.5 kg	2	Fish weight	Place in the dish in a swimming position.
P 14	Shoulder of pork	Boned, seasoned	Roasting dish without lid or universal pan	0.8–2.5 kg	2	Meat weight	The meat does not need to be seared beforehand.
P 15	Joint of pork , with crackling	E.g. shoulder, seasoned, and scored rind	Roasting dish without lid or universal pan	1.0–2.0 kg	2	Meat weight	Place in the cookware fatty side up; salt the rind well

Setting a program

You will be guided through the entire setting process for your chosen food.

1. Fill the water tank.
2. Use the function selector to set programs P. P 1 will appear on the display.
3. Use the < or > button to select the program.
4. Use the temperature selector to set the weight. The program will start after a few seconds.

Once the cooking time has elapsed, an audible signal will sound and the appliance will bring the operating mode to an end automatically. To silence the signal tone, press the  button.

If you are not satisfied with the cooking result, you can cook your food for a little longer.

Adding extra cooking time

Use the > button to set the amount of extra cooking time you want to add. The appliance will then start cooking the food for the extra time you set.

Cancelling

Turn the function selector to the function you require or back to "Programs" to select the program you require.

Switching off the appliance

Turn the function selector to the "Off" position.

Sabbath mode

Sabbath mode lets you set a cooking time of over 70 hours. This enables you to keep dishes in the cooking compartment warm without having to switch the appliance on or off.

Starting Sabbath mode

Before you can use Sabbath mode, you will need to activate it in the basic settings. → "Basic settings" on page 19

The appliance heats from the top and the bottom. You can set a temperature between 85 °C and 140 °C. The cooking time can be adjusted to the nearest half hour between 24 and 72 hours.

1. Use the function selector to set bottom heating . **SAb** will appear on the display.
2. Use the temperature selector to set the temperature.
3. Use the < and > buttons to set the cooking time.

Note: The end time cannot be delayed.

The appliance will start heating after a few seconds. The cooking time will count down on the display.

Once the Sabbath mode cooking time comes to an end, the appliance will stop heating.

To switch off, turn the function selector back to the "Off" position.

Changing and cancelling

The settings cannot be changed once the appliance has started.

If you would like to cancel Sabbath mode, switch the appliance off by turning the function selector to the "Off" position.

Home Connect

This appliance is Wi-Fi-capable and can be remotely controlled using a mobile device.

If the appliance is not connected to the home network, the appliance functions in the same way as an oven with no network connection and can still be operated via the display.

The availability of the Home Connect function depends on the availability of Home Connect services in your country. Home Connect services are not available in every country. You can find more information on this at www.home-connect.com.

Notes

- Ensure that you follow the safety instructions in this instruction manual and that you comply with these even when you are away from home and are operating the appliance via the Home Connect app. You must also follow the instructions in the Home Connect app. → "Important safety information" on page 5
- Operating the appliance directly from the appliance always has priority. During this time, it is not possible to operate the appliance using the Home Connect app.

Setting up

To set up Home Connect for your appliance, you require the following:

- Your appliance that is connected to the power supply and switched on,
- A smartphone or tablet with a current version of the iOS or Android operating system,
- And your appliance within range of your home network's Wi-Fi signal.

1. Download the Home Connect app (household).



2. Open the Home Connect app (household) and scan the QR code.



3. Follow the instructions in the Home Connect (household) app.

Remote Start

To start and operate your appliance via the Home Connect app, you must activate remote start. If remote start is not activated, you can only view the operating statuses in the Home Connect app and configure your appliance's settings.

Note: If you open the appliance door 15 minutes after remote start activation or the end of operation, the remote start is automatically deactivated.

Warning – Fire hazard!

Combustible objects that are left in the cooking compartment may catch fire. Never store combustible objects in the cooking compartment.

Activating remote start

Turn the function selector to .

Home Connect settings

You can adjust Home Connect to suit your requirements at any time.

Note: You will find the Home Connect settings in your appliance's basic settings. Which settings the display shows will depend on whether Home Connect has been set up and whether the appliance is connected to your home network.

Setting		Selection/display
HCO1	Network connection	0 = Not connected* 1 = Connect automatically 2 = Connect manually 3 = Connected*
HCO2	Pairing (connecting to the app)	0 = Ready 1 = Connect appliance 2 = Appliance is connected*
HCO3	Wi-Fi	0 = Switch off 1 = Switch on If Wi-Fi has been activated, you can use the Home Connect functions. In networked standby mode, the appliance requires a maximum of 2 W.
HCO4	Remote control behaviour	0 = Monitoring You can display the operating statuses of your appliance in the Home Connect app. 1 = Manual remote start** You can operate and start your appliance remotely. However, you must activate the remote start before each operation. 2 = Continuous remote start You can always operate and start your appliance always remotely without having to activate remote start.
HCO5	Software update	0 = No update available* 1 = Update available* 2 = Start an available update
HCO6	Allow remote diagnostics	0 = No** 1 = Yes

* Display value (not adjustable)

** Factory setting

Remote diagnostics

Customer Service can use Remote Diagnostics to access your appliance if you contact them, have your appliance connected to the Home Connect server and if Remote Diagnostics is available in the country in which you are using the appliance.

Note: For further information and details about the availability of Remote Diagnostics in your country, please visit the service/support section of your local website: www.home-connect.com

About data protection

When your appliance is connected for the first time to a WLAN network, which is connected to the Internet, your appliance transmits the following categories of data to the Home Connect server (initial registration):

- Unique appliance identification (consisting of appliance codes as well as the MAC address of the installed WiFi communication module).
- Security certificate of the WiFi communication module (to ensure a secure IT connection).
- The current software and hardware version of your domestic appliance.
- Status of any previous resetting to factory settings.

This initial registration prepares the Home Connect functions for use and is only required when you want to use these Home Connect functions for the first time.

Note: Ensure that the Home Connect functions can be used only in conjunction with the Home Connect app. Information on data protection can be accessed in the Home Connect app.

Declaration of Conformity

Constructa Neff Vertriebs-GmbH hereby declares that the appliance with functionality meets the basic requirements and other relevant provisions of Directive 2014/53/EU.

A detailed RED Declaration of Conformity can be found online at www.neff-international.com among the additional documents on the product page for your appliance.



2.4 GHz band: max. 100 mW
5 GHz band: max. 100 mW

	BE	BG	CZ	DK	DE	EE	IE	EL
	ES	FR	HR	IT	CY	LV	LT	LU
	HU	MT	NL	AT	PL	PT	RO	SI
	SK	FI	SE	UK	NO	CH	TR	

5 GHz Wi-Fi: for indoor use only

Cleaning agent

With good care and cleaning, your appliance will retain its appearance and remain fully functioning for a long time to come. We will explain here how you should correctly care for and clean your appliance.

Suitable cleaning agents

To ensure that the different surfaces are not damaged by using the wrong cleaning agent, observe the information in the table. Depending on the appliance model, not all of the areas listed may be on/in your appliance.

Caution!

Risk of surface damage

Do not use:

- Harsh or abrasive cleaning agents,
- Cleaning agents with a high alcohol content,
- Hard scouring pads or cleaning sponges,
- High-pressure cleaners or steam cleaners,
- Special cleaners for cleaning the appliance while it is hot.

Wash new sponge cloths thoroughly before use.

Tip: Highly recommended cleaning and care products can be purchased through the after-sales service. Observe the respective manufacturer's instructions.

Warning – Risk of burns!

The appliance becomes very hot. Never touch the interior surfaces of the cooking compartment or the heating elements. Always allow the appliance to cool down. Keep children at a safe distance.

Area	Cleaning
Appliance exterior	
Stainless steel front	Hot soapy water: Clean with a dish cloth and then dry with a soft cloth. Remove flecks of limescale, grease, starch and albumin (e.g. egg white) immediately. Corrosion can form under such flecks. Special stainless steel cleaning products suitable for hot surfaces are available from our after-sales service or from specialist retailers. Apply a very thin layer of the cleaning product with a soft cloth.
Plastic	Hot soapy water: Clean with a dish cloth and then dry with a soft cloth. Do not use glass cleaner or a glass scraper.
Painted surfaces	Hot soapy water: Clean with a dish cloth and then dry with a soft cloth.
Control panel	Hot soapy water: Clean with a dish cloth and dry with a soft cloth. Do not use glass cleaner or a glass scraper. If descaler comes into contact with the control panel, wipe it off immediately. If you leave it, it may stain the control panel.

Door panels	Hot soapy water: Clean with a dish cloth and then dry with a soft cloth. Do not use a glass scraper or a stainless steel scouring pad.
Door handle	Hot soapy water: Clean with a dish cloth and then dry with a soft cloth. If descaler comes into contact with the door handle, wipe it off immediately. Otherwise, any stains will not be able to be removed.
Appliance interior	
Enamel surfaces and self-cleaning surfaces	Observe the instructions for the surfaces of the cooking compartment that follow the table.
Glass cover for the interior lighting	Hot soapy water: Clean with a dish cloth and then dry with a soft cloth. If the cooking compartment is heavily soiled, use oven cleaner.
Door seal Do not remove.	Hot soapy water: Clean with a dishcloth. Do not scour. Check the position of the door seal after cleaning it. → "After cleaning" on page 25
Door cover	made from stainless steel: Use stainless steel cleaner. Follow the manufacturers' instructions. Do not use stainless steel care products. made from plastic: Clean using hot soapy water and a dish cloth. Dry with a soft cloth. Do not use glass cleaner or a glass scraper. Remove the door cover for cleaning.
Rails	Hot soapy water: Soak and clean with a dish cloth or brush.
Pull-out system	Hot soapy water: Clean with a dish cloth or a brush. Do not remove the lubricant while the pull-out rails are pulled out – it is best to clean them when they are pushed in. Do not clean in the dishwasher.
Accessories	Hot soapy water: Soak and clean using a dishcloth or brush. If there are heavy deposits of dirt, use a stainless steel scouring pad. Enamelled accessories are dishwasher-safe.
Water tank	Hot soapy water: Clean with a dish cloth and rinse thoroughly to remove residual detergent. Then dry with a soft cloth. Leave the water tank to dry with the lid open. Rub the seal on the lid until dry. Do not clean in the dishwasher.

Notes

- Slight differences in colour on the front of the appliance are caused by the use of different materials, such as glass, plastic and metal.
- Shadows on the door panels, which look like streaks, are caused by reflections made by the interior lighting.
- Enamel is baked on at very high temperatures. This can cause some slight colour variation. This is normal and does not affect operation. The edges of thin trays cannot be completely enamelled. As a result, these edges can be rough. This does not impair the anti-corrosion protection.

Surfaces in the cooking compartment

The back wall in the cooking compartment is self-cleaning. You can tell this from the rough surface.

The base, ceiling and side panel are enamelled and have smooth surfaces.

Cleaning enamel surfaces

Clean the smooth enamel surfaces with a dish cloth and hot soapy water or a vinegar solution. Then dry them with a soft cloth.

Soften baked-on food remnants with a damp cloth and soapy water. Use stainless steel wire wool or oven cleaner to remove stubborn dirt.

Caution!

Never use oven cleaner in the cooking compartment when it is still warm. This may damage the enamel. Remove all food remnants from the cooking compartment and the appliance door before you next heat up the appliance.

Leave the cooking compartment open to dry after cleaning it.

Note: Food residues can cause white deposits to form. These are harmless and do not affect how the appliance works. You can remove these residues using lemon juice if required.

Cleaning self-cleaning surfaces

The self-cleaning surfaces are coated with a porous, matte ceramic layer. This coating absorbs and dispels splashes from baking and roasting while the appliance is in operation.

If the self-cleaning surfaces no longer clean themselves sufficiently and dark stains appear, they can be cleaned using targeted heating.

Making settings

Remove the rails, pull-out shelves, accessories and ovenware from the cooking compartment beforehand. Thoroughly clean the smooth enamel surfaces in the cooking compartment, the inside of the appliance door and the glass cover on the interior lighting.

1. Set the type of heating for baking bread.
2. Set the maximum temperature.
3. Start the mode and leave it to run for at least one hour.

The ceramic coating is regenerated.

When the cooking compartment has cooled down, remove the brown or white residue with water and a soft sponge.

Note: During operation, reddish spots form on the surfaces. This is not rust, but residues from food. These spots are not harmful and do not restrict the cleaning ability of the self-cleaning surfaces.

Caution!

Do not use oven cleaner on the self-cleaning surfaces. This will damage the surfaces. If oven cleaner does get onto these surfaces, dab it off immediately using water and a sponge cloth. Do not rub the surface and do not use abrasive cleaning aids.

After cleaning

After cleaning the door seal, check whether it is sitting correctly on the left- and right-hand side (fig. 1).

If the door seal is running over the spacer **a**, push the door seal inwards so that it now runs beside the spacer **a** (fig. 2).

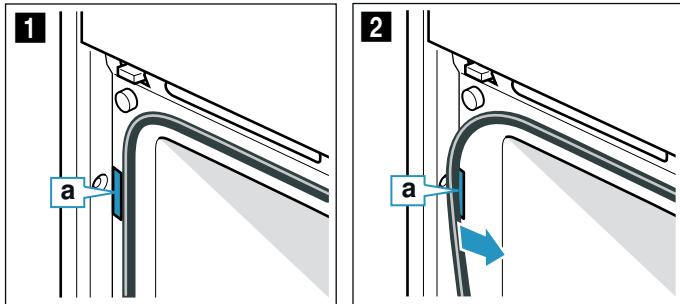

Keeping the appliance clean

Always keep the appliance clean and remove dirt immediately so that stubborn deposits of dirt do not build up.

⚠ Warning – Risk of fire!

Loose food remnants, fat and meat juices may catch fire. Before using the appliance, remove the worst of the food remnants from the cooking compartment, heating elements and accessories.

Tips

- Clean the cooking compartment after each use. This will ensure that dirt cannot be baked on.
- Always remove flecks of limescale, grease, starch and albumin (e.g. egg white) immediately.
- Use the universal pan for baking very moist cakes.
- Use suitable ovenware for roasting, e.g. a roasting dish.

Cleaning function

Your appliance has the "Descaling" operating mode. You can use the "descaling" operating mode to remove limescale from the evaporator.

Descaling

To ensure that your appliance continues to operate correctly, it must be descaled regularly.

The frequency with which the appliance must be descaled depends on the hardness of the water used. The  symbol appears on the display if the appliance needs to be descaled.

There are four steps in the descaling programme. For hygiene reasons, the descaling programme must be run through completely before the appliance is ready for operation again. Descaling takes around 90–110 minutes in total:

- First step (1_4): Descale (approx. 65 minutes), then empty and refill the water tank
- Second step (2/4): Rinse (approx. 9 minutes), then empty and refill the water tank
- Third step (3_4): Rinse (approx. 9 minutes), then empty and refill the water tank
- Fourth step (4_4): Rinse (approx. 9 minutes), then empty and dry the water tank



Start descaling

Caution!

- Risk of damage to the appliance: Only use the liquid descaler recommended by us for the descaling programme. The length of time for which the descaler is left to work is based on this product. Using other descalers may damage the appliance. Descaler order no. 311 680
- Descaling solution: Do not allow any descaling solution or descaler to come into contact with the control panel or other surfaces on the appliance. This may damage the surfaces. If this does happen, remove the descaling solution immediately with water.

Note: Do not pour more than 150 ml of liquid into the water tank throughout the descaling process.

First step (1_4)

1. Mix 100 ml water with 50 ml liquid descaler to make a descaling solution.
2. Pour the descaling solution into the water tank and insert the water tank.
3. Use the function selector to set the cleaning functions . The  symbol and the cleaning functions appear on the display. The first cleaning function is highlighted.
4. Press the **>** or **<** button repeatedly until the  symbol is highlighted. "CLC" appears on the display.

- Turn the temperature selector.
"0h" appears on the display. Descaling starts after a few seconds.
- After operation of the descaling programme, "2/4" appears on the display. Remove the water tank and clean thoroughly with water.

Second step (2/4)

- Fill the water tank with 150 ml water and insert it.
- After operation of the rinse cycle, "3_4" appears on the display. Remove the water tank and clean thoroughly with water.

Third step (3/4)

- Fill the water tank with 150 ml water and insert it.
- After operation of the rinse cycle, "4_4" appears on the display. Remove the water tank and clean thoroughly with water.

Fourth step (4/4)

- Fill the water tank with 150 ml water and insert it.
- After operation of the rinse cycle, "00:00" appears on the display and the operation ends. Remove the water tank and clean thoroughly with water.

After descaling

- Dry the water tank.
 - Reinsert the water tank.
- Descaling is complete and the appliance is ready for use again.

Descaling programme interrupted

If descaling is interrupted (for example, due to a power failure or because the appliance is switched off), the descaling symbol appears on the display after the appliance is switched back on. You will be prompted to rinse three times. The appliance cannot be used for other operations until the third rinse cycle comes to an end. If you set another operation, "C i" (Cleaning) appears on the display. Repeat the interrupted descaling programme after rinsing.

- Empty the water tank and clean thoroughly with water.
- Insert the empty water tank.
- Use the function selector to set descaling.
- Turn the temperature selector.
"0h" appears on the display. After a few seconds, the remaining liquid pumped back.
- Empty the water tank and clean thoroughly with water.
- To rinse the steam system, run the three rinse cycles in the descaling programme.
- Restart descaling.

Rails

With good care and cleaning, your appliance will retain its appearance and remain fully functional for a long time to come. This will tell you how to remove the shelves and clean them.

Detaching and refitting the rails

Warning – Risk of burns!

The rails become very hot. Never touch the hot rails. Always allow the appliance to cool down. Keep children away from the appliance.

Detaching the rails

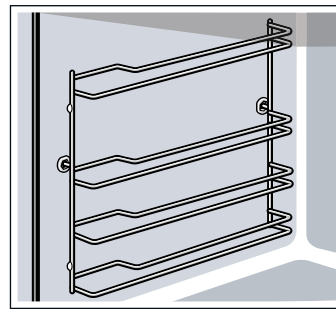

- Lift the rail slightly at the front **a** and detach it **b** (fig. **1**).
- Then pull the whole rail to the front and remove it (fig. **2**).

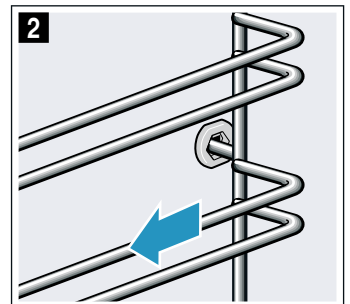
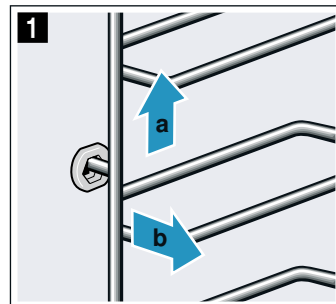

Clean the rails with cleaning agent and a sponge. For stubborn dirt deposits, use a brush.

Attaching the rails

The rails only fit on the right or the left side. For both rails, ensure that the curved rods are at the front.

1. First, insert the rail in the middle of the rear socket **a**, until the rail rests against the cooking compartment wall, and push it back **b** (figure **1**).
2. Then insert the rail into the front socket **c**, until the rail also rests against the cooking compartment wall here, and press it downwards **d** (figure **2**).

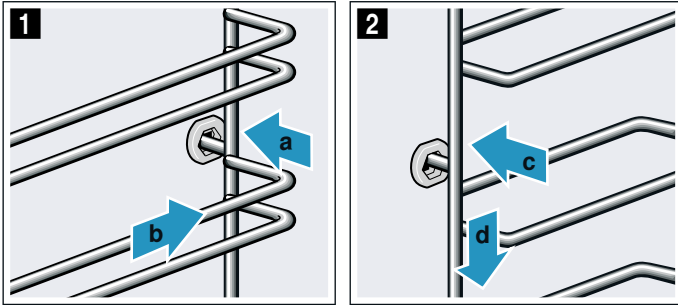

Appliance door

With good care and cleaning, your appliance will retain its appearance and remain fully functional for a long time to come. This will tell you how to remove the appliance door and clean it.

Removing and fitting the appliance door

To clean the door panels, you can detach the appliance door.

⚠ Warning – Risk of injury!

The hinges of the appliance door may snap shut with great force. Always fully turn the two locks for fitting and removing the appliance door.

⚠ Warning – Risk of injury!

If the appliance door has been removed without turning both locking levers to their limit stops, the hinge may snap shut. Do not reach into the hinge. Call the after-sales service.

Detaching the appliance door

1. Open the left- and right-hand door locks (fig. **1**).
To do this, hold the screwdriver horizontally and use it to push the door lock (black component) on each side of the door all the way up (fig. **2**).

Tip: Use a torch to light up the gap so that you can see the door locks.

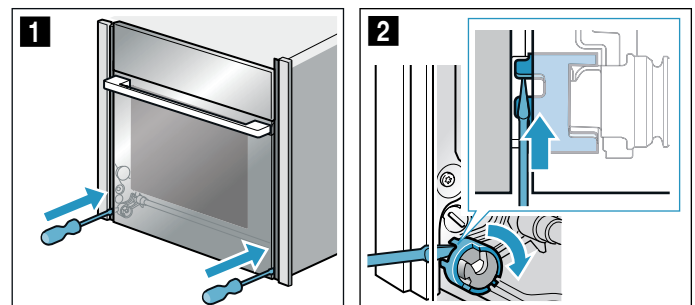

Door lock closed (fig. **3**)

Door lock open (fig. **4**)

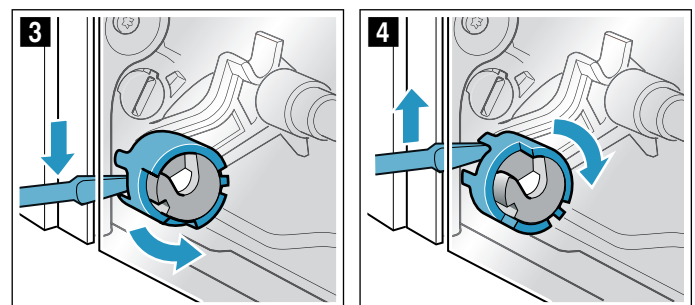

2. Open the appliance door approx. 45° (fig. 5).

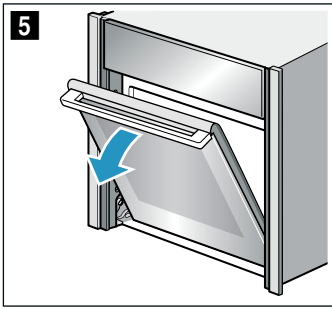

3. Using a coin, turn both the left- and right-hand locks on the inside of the appliance at the bottom as far as they will go.

Left-hand lock: Clockwise

Right-hand lock: Anti-clockwise

The arrows will now be pointing to one another and the lock will click into place (fig. 6).

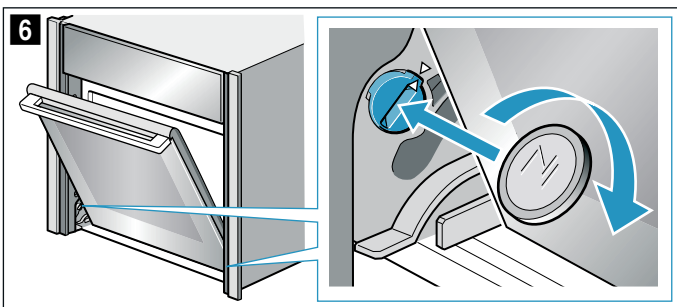

Left-hand lock secured (fig. 7)

Right-hand lock released (fig. 8)

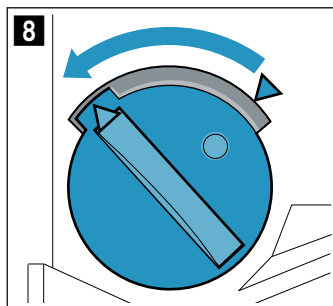
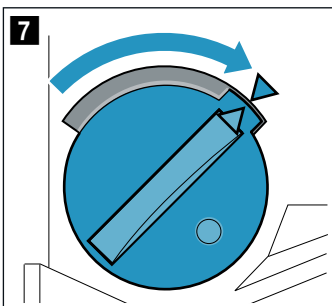

4. Move the appliance door back and forth until you hear a quiet click (fig. 9).

The appliance door is now in the lock position. You will only be able to move it slightly.

Caution!

Risk of damaging the door hinges. Do not force the appliance door open or closed when it is in the lock position.

If you have forced the appliance door open or closed when it was in the lock position, please contact our after-sales service.

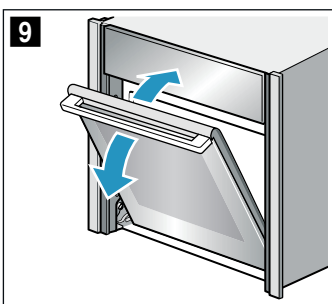

Warning

Risk of injury!

The door handle may break off. Do not carry the appliance door by the door handle. To carry or remove the appliance door, take hold of it with both hands, one on the left and one on the right.

5. Take hold of the appliance door with both hands, one on the left and one on the right, and rotate the door handle upwards slightly **a** until you are able to pull up the appliance door and remove it **b** (fig. 10).

Warning

Risk of injury!

Do not drop the appliance door.

The appliance door weighs 7 - 10 kg – handle it with care.

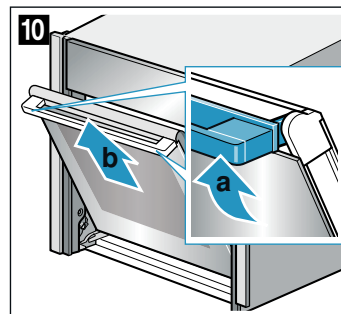

6. Set the appliance door down on a flat, soft, clean surface.

Refitting the appliance door

1. Slide the appliance door over the left- and right-hand guide rollers simultaneously (fig. 1 and 2). Ensure that the appliance door is not wedged at an angle and that it is properly fitted in place.

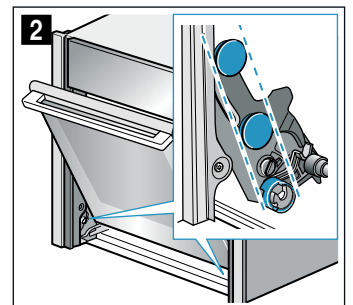
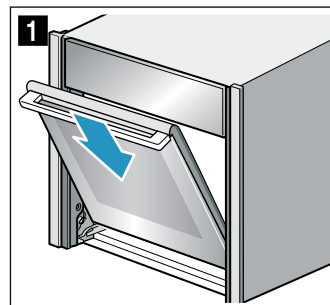

2. Rotate the door handle upwards slightly **a** (fig. 3). The appliance door will slide the short distance remaining to the bottom **b** (fig. 3).

3. Use a coin to release the locks on both sides of the appliance door (fig. 4).

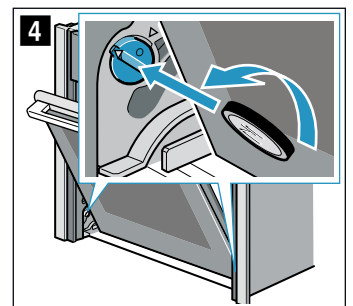
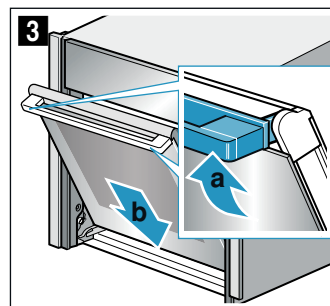

Left-hand lock: Anti-clockwise
Right-hand lock: Clockwise

- Open the appliance door slightly until you hear a quiet click. Close the appliance door.

⚠ Warning

Risk of injury if the door locks are not closed!

The appliance door may become detached. You may be injured and the appliance door damaged. After refitting the door, always close the left- and right-hand door locks.

- Close the left- and right-hand door locks (fig. 5). To do this, hold the screwdriver horizontally and use it to push the door lock on each side of the door all the way down (fig. 6).

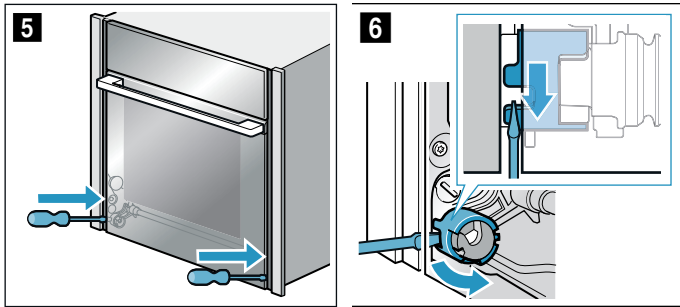

Removing and installing the door panels

For cleaning, you can remove the glass panels from the appliance door.

To do this, the appliance door must be removed beforehand (see section "Removing and fitting the appliance door").

⚠ Warning – Risk of injury!

The appliance must not be used again until the door panels and appliance door have been correctly fitted.

⚠ Warning – Risk of injury!

Components inside the appliance door may have sharp edges. Wear protective gloves.

Removal

Note: Lay the removed glass panels on an even, soft and clean surface.

- Remove the appliance door.
- Lay the appliance door with the front side facing down on an even, soft and clean surface.
- Push on the left- and right-hand side on the outside of the appliance door until the inner glass is released on both sides (Fig. 1).
- Carefully lift the inner glass and remove it in the direction of the arrow (Fig. 2).

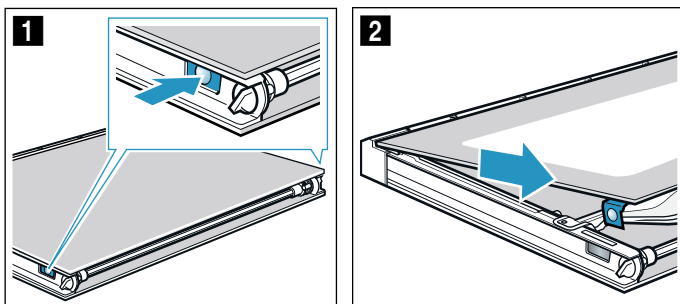

- Push the intermediate panel downwards in the **a** area, carefully lift the **b** holder until it can be pulled out (Fig. 3).
- Lift the intermediate panel from below (Fig. 4) and remove it.

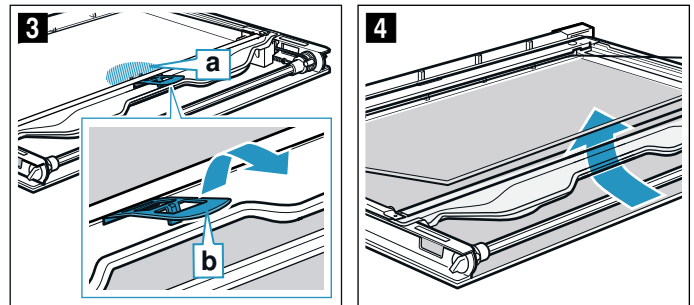

- Clean all panels on both sides with glass cleaner and a soft cloth.

⚠ Warning

Risk of injury!

Scratched glass in the appliance door may develop into a crack. Do not use a glass scraper, or sharp or abrasive cleaning aids or detergents.

- Dry and refit all panels.

Installation

Note: When fitting the door panels, ensure that they are in the original order.

- Insert the intermediate panel and push it in the direction of the arrow until it is fitted in the frame. The arrow on the intermediate panel must line up with the arrow on the frame (Fig. 1).

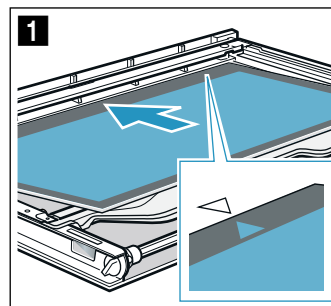

- Push the intermediate panel downwards in the **a** area, insert the **b** holder at an angle and push down until it locks into place (Fig. 2). The holder is inserted (Fig. 3).

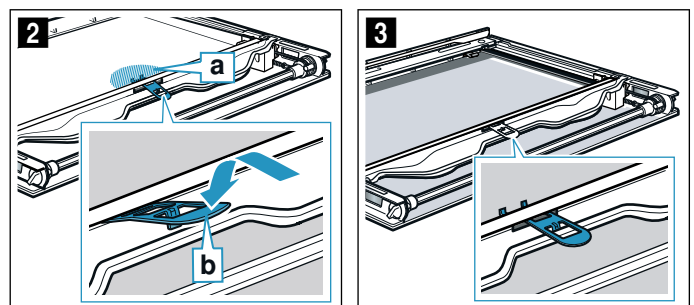

3. Insert the inner glass into the holder **c** on the left and right (Fig. 4).
4. Push the inner glass downwards until it locks into place (Fig. 5).

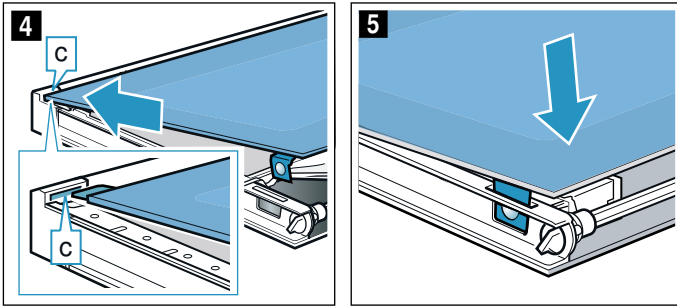

? Trouble shooting







If a fault occurs, there is often a simple explanation. Before calling the after-sales service, please refer to the fault table and attempt to correct the fault yourself.

Rectifying faults yourself

You can often easily rectify technical faults with the appliance yourself.

If a dish does not turn out exactly as you wanted, you can find useful cooking tips and instructions at the end of this instruction manual. → "Tested for you in our cooking studio" on page 33

Fault	Possible cause	Notes/remedy
The appliance is not working.	Defective circuit breaker.	Check the circuit breaker in the fuse box.
	Power failure	Check whether the kitchen light or other kitchen appliances are working.
Steam-assisted operation does not start.	Water tank is empty.	Fill the water tank.
	Descaling locks operations with steam.	Carry out descaling.
	Defective steam system.	Call after-sales service.
Cooked dishes turn out too moist or too dry when cooking with steam-assisted applications	The wrong steam intensity was selected	Select a higher or lower steam intensity
Steam escapes from the ventilation slots during cooking	Normal procedure	Not possible
The "fill water tank" symbol lights up continuously	No water in the water tank.	Fill the water tank.
	The water tank has not been put in fully.	Put the water tank in fully.
	The sensor is defective.	Call after-sales service.
	The water tank is leaking.	Order a new water tank.
The time is flashing on the display.	Power failure.	Reset the time.
After switching on an operating mode, h flashes in the display.	The appliance has not cooled down sufficiently.	Switch off the appliance, allow it to cool down and switch the operating mode on again.

No settings can be made on the appliance. The symbol  lights up in the display.	The childproof lock is activated.	Press and hold the  button until the  symbol goes out in the display. Settings can be made on the appliance. The childproof lock can be deactivated in the basic settings. → "Basic settings" on page 19
The "descale" symbol appears in the display. → "Getting to know your appliance" on page 9	Build-up of limescale in appliance.	Run the descaling programme in full. → "Cleaning function" on page 25
 appears in the display.	The power supply has been disconnected or the appliance has been switched off during the descaling process.	Run "Descaling interrupted" in full. → "Cleaning function" on page 25
E5 122 appears in the display.	There is too much water in the steam system. The water cannot be pumped back into the water tank.	Empty the water tank then insert it. Touch the  button. Reset the time. Switch off the appliance and switch it back on again. Run "Descaling interrupted" in full. → "Cleaning function" on page 25
The appliance is not heating. "DEMO" is shown on the display.	Demo mode is activated.	Briefly disconnect the appliance from the mains (switch off the circuit breaker in the fuse box) and then deactivate demo mode within approx. 5 minutes by changing the basic setting  to  . → "Basic settings" on page 19
Home Connect does not work correctly.		Go to www.home-connect.com

 Warning – Risk of injury!

Incorrect repairs are dangerous. Do not attempt to repair the appliance yourself. Repairs must only be carried out by one of our trained after-sales engineers. If the appliance is defective, call the after-sales service.

 Warning – Risk of electric shock!

Incorrect repairs are dangerous. Repairs may only be carried out and damaged power cables replaced by one of our trained after-sales technicians. If the appliance is defective, unplug the appliance from the mains or switch off the circuit breaker in the fuse box. Contact the after-sales service.

Error messages on the display

If an error message with "E" appears on the display, e.g. **E05-32**, touch the  button. This will reset the error message. Reset the time, if necessary.

If the fault was a one-off, you can continue to use your appliance as normal. If the error message appears again, call our after-sales service and quote the exact error message and the E no. of your appliance.
→ "Customer service" on page 32

Maximum operating time

If you do not change the settings on your appliance for several hours, the appliance will stop heating automatically. This prevents unintentional continuous operation.

When the maximum operating time is reached depends on the various different settings that have been configured on the appliance.

Maximum operating time reached

F8 appears on the display.

Turn the function selector to the "Off" position. You can configure new settings if required.

Tip: To prevent the appliance from switching off when you do not want it to, e.g. with an extremely long cooking time, you should always set a cooking time. The appliance will heat up until the set cooking time has elapsed.

Replacing the bulb in the top of the cooking compartment

If the cooking compartment light bulb fails, it must be replaced. Heat-resistant, 25 watt, 230 V halogen bulbs are available from the after-sales service or specialist retailers.

When handling the halogen bulb, use a dry cloth. This will increase the service life of the bulb. Only use these bulbs.

 Warning – Risk of electric shock!

When replacing the cooking compartment bulb, the bulb socket contacts are live. Before replacing the bulb, unplug the appliance from the mains or switch off the circuit breaker in the fuse box.

 Warning – Risk of burns!

The appliance becomes very hot. Never touch the interior surfaces of the cooking compartment or the heating elements. Always allow the appliance to cool down. Keep children at a safe distance.

- 1. Place a tea towel in the cold cooking compartment to prevent damage.
- 2. Turn the glass cover anti-clockwise to remove it (figure 1).
- 3. Pull out the bulb – do not turn it (figure 2). Insert the new bulb, making sure that the pins are in the correct position. Push the bulb in firmly.

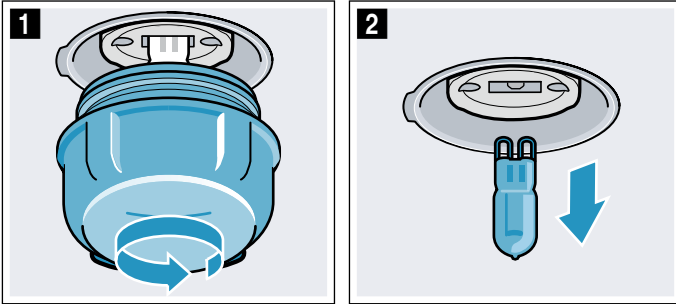

- 4. Screw the glass cover back on. Depending on the appliance model, the glass cover may have a sealing ring. If the glass cover has a sealing ring, put it back in place before screwing the cover back on.
- 5. Remove the tea towel and switch on the circuit breaker.

Customer service

Our after-sales service is there for you if your appliance needs to be repaired. We will always find an appropriate solution, also in order to avoid after-sales personnel having to make unnecessary visits.

E number and FD number

When calling us, please give the full product number (E no.) and the production number (FD no.) so that we can provide you with the correct advice. The rating plate bearing these numbers can be found on the base of the appliance when you open the appliance door.

.....		
.....		
	E-Nr:	FD: Z-Nr:
Type:	

To save time, you can make a note of the number of your appliance and the telephone number of the after-sales service in the space below, should it be required.

E no.	FD no.
-------	--------

After-sales service

Please note that a visit from an after-sales service engineer is not free of charge in the event that the appliance has been misused, even during the warranty period.

Please find the contact data of all countries in the enclosed customer service list.

To book an engineer visit and product advice

- GB** 0344 892 8989
Calls charged at local or mobile rate.
- IE** 01450 2655
0.03 € per minute at peak. Off peak 0.0088 € per minute.

Rely on the professionalism of the manufacturer. You can therefore be sure that the repair is carried out by trained service technicians who carry original spare parts for your appliances.

Tested for you in our cooking studio

Here, you can find a selection of dishes and the ideal settings for them. We will show you which type of heating and temperature are best suited to your dish. You will get information on suitable cooking accessories and the height at which they should be placed in the oven. You will also get tips about cookware and preparation methods.

Note: A lot of steam can build up in the cooking compartment when cooking food. Your appliance is very energy-efficient and radiates very little heat to its surroundings during operation. Due to the high difference in temperature between the appliance interior and the external parts of the appliance, condensation may build up on the door, control panel or adjacent kitchen cabinet panels. This is a normal physical phenomenon. Condensation can be reduced by preheating the oven or opening the door carefully. During operation with steam assistance, it is desirable that there is a significant build-up of steam in the cooking compartment. Wipe the cooking compartment clean after cooking, once it has cooled off.

Caution!

Never pour water into the hot cooking compartment or place cookware containing water onto the bottom of the cooking compartment. The change in temperature can cause damage to the enamel.

General information

Recommended setting values

The table lists the optimal heating type for various types of food. The temperature and cooking time are dependent on the quantity of food and the recipe. Settings ranges are indicated for this reason. Try using the lower values to start with. A lower temperature will result in more even browning. You can use a higher setting next time if necessary.

Note: Cooking times cannot be reduced by using higher temperatures. The food would only be cooked on the outside, but would not be fully baked in the middle.

The setting values apply to food that is placed into a cold cooking compartment. By doing so, you can make energy savings of up to 20 per cent. If you preheat the oven, you can reduce the indicated baking times by several minutes.

Preheating is necessary for selected food, and this is indicated in the table. Do not place your food or accessories into the cooking compartment until it has finished preheating.

If you wish to follow one of your own recipes when baking, you should use the setting values listed for similar food in the table as reference. Additional information can be found in the baking tips listed after the settings tables.

Remove unused accessories from the cooking compartment. This will ensure that you achieve the best possible cooking results and energy savings of up to 20 per cent.

Accessories

Only use original accessories supplied with your appliance. These have been tailored to the cooking compartment and the operating modes of your appliance.

Ensure that you always use suitable accessories and that they are placed in the oven the right way around.
→ "Accessories" on page 11

Greaseproof paper

Only use greaseproof paper that is suitable for the selected temperature. Always cut greaseproof paper to size.

CircoTherm gentle heating function

CircoTherm gentle is an intelligent heating function that allows you to gently cook meat, fish and baked items. The appliance optimally controls the supply of energy to the cooking compartment. The food is cooked in phases using residual heat. This means that it remains more succulent and browns less. Depending on the method of preparation and the type of food, it is possible to save energy. If you open the appliance door before the food has finished cooking or if you preheat the appliance, you may not be able to achieve this result.

Only use genuine accessories for your appliance. These have been tailored to the cooking compartment and the heating functions of your appliance. Remove any accessories that are not being used from the cooking compartment.

Place the food into the empty cooking compartment before the oven is heated up. Always keep the appliance door closed when cooking. Only cook on one level when using this function.

The CircoTherm gentle heating function is used to measure both the energy consumption in air recirculation mode and the energy efficiency class.

Steam-assisted baking

Certain dishes (e.g. yeast-risen pastries) get a more crispy crust and a more glossy surface if baked with the steam-assisted cooking mode. The baked item does not dry out as much.

Steam-assisted baking is only possible on one level.

Some dishes turn out best if they are cooked in multiple stages. These are indicated in the table.

Baking

Here, you can find recommended settings for many dishes.

In addition, refer to the information in the section on proving dough.

Baking on one level

When baking on one level, use the following shelf positions:

- Tall baked goods or tin on wire rack: Level 2
- Flat baked goods or goods in a baking tray: Level 3

Baking on two or more levels

Use CircoTherm. Items that are placed in the oven on baking trays or in baking tins/dishes at the same time will not necessarily be ready at the same time.

Baking on two levels:

- Universal pan: Level 3
Baking tray: Level 1
- Baking tins/dishes on the wire rack
First wire rack: Level 3
Second wire rack: Level 1

Baking on 3 levels:

- Baking tray: Level 4
Universal pan: Level 3
Baking tray: Level 1

You can cut energy use by up to 45% by preparing items at the same time. Position baking tins/dishes either next to one another or offset on different shelves so that they are not directly one above the other in the cooking compartment.

Baking

Baking on one level

Food	Dish	Shelf position	Type of heating	Temperature in °C	Steam intensity	Time in minutes
Victoria sponge cake	2x Ø20cm tins	2	🌀	150-160	low	20-35
Light fruit cake	High Ø20cm tin	2	🌀	150-160	low	40
					-	50-70
Rich fruit cake	High Ø23cm tin	2	🌀	140-150	-	180-210
Fruit crumble	Flat glass dish	3	🌀	160-180*	-	30-40
Sponge Cake (fatless), 3 eggs	Springform cake tin Ø26cm	2	🌀	150-160	low	30-35
Swiss roll	Swiss roll tin	3	🌀	180-190*	low	10-15
Fruit Pie	Plate Ø20cm or pie tin	2	🌀	160-170	-	60-70
Quiche	Quiche tin (dark coated)	3	🌀	180-200	-	40-55
(White) Bread	Loaf tin (1x900g or 2x 450g)	2	☞	190-200	low	15
					-	15-25
Scones	Baking sheet on wire rack	3	≡	190-200*	-	10-15
Biscuits	Baking sheet on wire rack	3	🌀	140-160*	-	10-20
Small Cakes	12-cup-tin	3	≡	150**	-	25-35

* Preheat; do not use rapid heat-up function

** Preheat for 5 mins; do not use rapid heat-up function

*** Preheat with Hotair 180 °C

**** Preheat for 20 mins

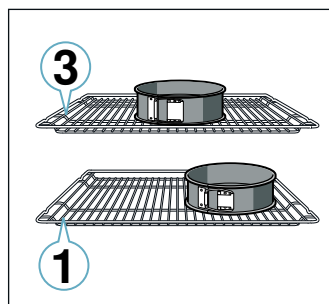

Baking tins

For optimal cooking results, we recommend using dark-coloured metal baking tins.

Tinplate baking tins, ceramic dishes and glass dishes extend baking time and mean that the baked item will not brown evenly.

If you are using silicone moulds, follow the manufacturer's instructions and recipes. Silicone moulds are often smaller than normal baking tins. Quantity and recipe specifications may vary.











Steam-assisted baking

Certain types of baked item (e.g. yeast-risen pastries, bread and bread rolls) get a more crispy crust and a more glossy surface if baked with steam-assisted cooking. The baked item does not dry out as much.













Steam-assisted baking is only possible on one level.

Some dishes turn out best if they are cooked in multiple stages. These are indicated in the table.

The baking tins must be resistant to heat and steam for preparing with steam-assisted cooking.

Food	Dish	Shelf position	Type of heating	Temperature in °C	Steam intensity	Time in minutes
Puff pastry slices	Universal pan	3		200-220*	low	15-25
Jam tarts	12-cup-tin	3		170-190*	-	15-25
Meringue	Baking sheet on wire rack	3		80-90*	-	120-150
Pavlova	Baking sheet on wire rack	3		100-110***	-	150-180
Choux pastry	Universal pan	3		200-220*	low	25-35
Meat Pie	rectangular pie tin	2		170-180	low	30
					-	20-30
Yorkshire pudding	12-cup-tin	3		200-220****	-	15-25
Jacket potatoes	Universal pan	3		180-190	high	20
					-	35-45
Pizza, homemade	Baking tray	3		210-230	-	20-30
Pizza, homemade, thin base	Pizza tray	2		250-270	-	8-13
* Preheat; do not use rapid heat-up function						
** Preheat for 5 mins; do not use rapid heat-up function						
*** Preheat with Hotair 180 °C						
**** Preheat for 20 mins						

Baking on two or more levels

Food	Dish	Shelf position	Type of heating	Temperature in °C	Time in minutes
Victoria sponge cake, 2 levels	4x Ø20cm tins	3+1		150-160*	20-30
Scones, 2 levels	2 baking sheets on 2 wire racks	3+1		160-180*	10-20
Biscuits, 2 levels	2 baking sheets on 2 wire racks	3+1		140-160*	15-25
Biscuits, 3 levels	3 baking sheets on 3 wire racks	4+3+1		140-160*	15-25
Small Cakes, 2 levels	2x 12-cup-tins	3+1		150**	20-30
Puff pastry slices, 2 levels	Universal pan + baking tray	3+1		170-190*	25-45
Puff pastry slices, 3 levels	Baking trays + universal pan	4+3+1		170-190*	25-45
Jam tarts, 2 levels	2x 12-cup-tins	3+1		170-190*	15-25
Meringue, 2 levels	2 baking sheets on 2 wire racks	3+1		90-100*	100-130
Jacket potatoes, 2 levels	Universal pan + baking tray	3+1		150-170*	75-90
(White) Bread, 2 levels	4x loaf tins	3+1		170-190*	30-40
Pizza, homemade, 2 levels	Universal pan + baking tray	3+1		180-200	35-45
* Preheat					
** Preheat for 5 mins; do not use rapid heat-up function					

Baking tips

You want to find out whether the baked item is completely cooked in the middle.	Push a cocktail stick into the highest point on the baked item. If the cocktail stick comes out clean with no dough residue, the baked item is ready.
The baked item collapses.	Next time, use less liquid. Alternatively, set the temperature 10 °C lower and extend the baking time. Adhere to the specified ingredients and preparation instructions in the recipe.
The baked item has risen in the middle but is lower around the edge.	Only grease the base of the springform cake tin. After baking, loosen the baked item carefully with a knife.
The fruit juice overflows.	Next time, use the universal pan.
Small baked items stick to one another during baking.	There should be a gap of approx. 2 cm around each item. This gives enough space for the baked items to expand well and brown on all sides.
The baked item is too dry.	Set the temperature 10 °C higher and shorten the baking time.
The baked item is too light in colour overall.	If the shelf position and the accessories are correct, then you should increase the temperature if necessary or extend the baking time.

The baked item is too light on top, and too dark underneath.	Bake the cake one level higher in the oven the next time.
The baked item is too dark on top, and too light underneath.	Bake the cake one level lower in the oven the next time. Select a lower temperature and extend the baking time.
The baked item is too dark in a tin or loaf tin.	Place the baking tray in the middle of the accessory, not directly against the back wall.
The baked item is too dark in colour overall.	Select a lower temperature next time and extend the baking time if necessary.
The baked item is unevenly browned.	Select a slightly lower temperature. Protruding greaseproof paper can affect the air circulation. Always cut greaseproof paper to size. Ensure that the baking tin does not stand directly in front of the openings in the cooking compartment back wall. When baking small items, you should use similar sizes and thicknesses wherever possible.
You were baking on several levels. The items on the top baking tray are darker than those on the lower baking tray.	Always select hot air when baking on several levels. Baked items that are placed into the oven on trays or in baking tins at the same time will not necessarily be ready at the same time.
The baked item looks good, but is not cooked properly in the middle.	Use a lower temperature and bake slightly longer; if necessary, add slightly less liquid. For baked items with a moist topping, bake the base first. Sprinkle it with almonds or breadcrumbs and then place the topping on top.
The baked item cannot be turned out of the dish when it is turned upside down.	Allow the baked item to cool down for 5 to 10 minutes after baking. If it still sticks, carefully loosen it around the edges again using a knife. Turn the baked item upside down again and cover it several times with a cold, wet cloth. Next time, grease the baking tin and sprinkle with breadcrumbs.

Roasting, braising and grilling

Here, you will find information on roasting, braising and grilling poultry, meat and fish. The settings tables list the optimal settings for a wide range of dishes.

Poultry

When cooking duck or goose, pierce the skin on the underside of the wings. This allows the fat to run out. If using duck breast, score the skin. Do not turn duck breasts.

Add some liquid to the poultry in the dish. Cover the base of the ovenware with approx. 1-2 cm of liquid.

When you turn poultry, ensure that the breast side or the skin side is underneath at first.

Poultry will turn out particularly crispy and brown if you baste it towards the end of the roasting time with butter, salted water or orange juice.

Meat

Baste lean meat with fat as required or cover it with strips of bacon. Score the rind crosswise. If you turn the joint when cooking it, ensure that the rind is underneath to begin with.

When the joint is ready, turn off the oven and allow it to rest for a further 10 minutes in the cooking compartment, keeping the door closed. This helps distribute the meat juices more evenly. Wrap the joint in aluminium foil if necessary. The recommended resting time is not included in the indicated cooking time.

Fish

Whole fish does not need to be turned. Place the whole fish into the cooking compartment in its swimming position, with the dorsal fin at the top. Placing half a potato or a small oven-proof container in the stomach cavity of the fish will keep it upright.

You can tell when the fish is cooked because the dorsal fin can be removed easily.

Roasting and braising on the wire rack

On the wire rack, poultry and meat will become very crispy on all sides. Roasting on the wire rack works particularly well for large poultry or for multiple pieces at the same time.

Add up to 1/2 litre of water to the universal pan, depending on the size and type of meat. Any dripping fat and meat juices will be caught. You can make a sauce from these juices. This will also result in less smoke being produced and keep the cooking compartment cleaner.

Slide the universal pan into the oven at the indicated shelf position with the wire rack on top. Ensure that the wire rack is correctly positioned on the universal pan.

Roasting and braising in cookware

⚠ Warning – Risk of injury from shattering glass!
Place hot glass cookware on a dry mat after cooking. The glass may crack if placed on a cold or wet surface.

⚠ Warning – Risk of scalding!
Very hot steam may escape when opening the lid after cooking. Lift the lid at the rear, so that the hot steam can escape away from you.

It is more convenient to roast and braise meat in cookware. You can take the joint out of the cooking compartment more easily in the cookware, and prepare the sauce in the cookware itself.

Only use cookware that is suitable for use in an oven. Check whether the cookware fits in the cooking compartment.

It is best to use glass cookware. Place hot glass cookware onto a dry mat after cooking. The glass may crack if placed on a cold or wet surface.

When roasting poultry and other meat, add a little liquid.

The liquid in the cookware evaporates as the meat roasts. Carefully pour in more liquid if required.

Shiny roasting dishes made from stainless steel or aluminium reflect heat like a mirror and are therefore not particularly suitable. The meat cooks more slowly and does not brown so well. Use a higher temperature and/or a longer cooking time.

Follow the manufacturer's instructions for your roasting dishes.

Roasting in uncovered cookware

It is best to use a deep roasting dish for roasting poultry and meat. Place the dish onto the wire rack. If you do not have any suitable cookware, use the universal pan.

Braising in covered cookware

Cooking with covered cookware keeps the cooking compartment considerably cleaner. Ensure that the lid fits well and closes properly. Place the cookware onto the wire rack.

The distance between the meat and the lid should be at least 3 cm, as the meat may expand.

Very hot steam may escape when the lid is opened after cooking. Lift the lid at the rear, so that the hot steam can escape away from you.

To braise the meat, sear it first as required. Add water, wine, vinegar or a similar liquid to the braising liquid. Cover the bottom of the cookware with at least 2 cm of liquid.

The liquid in the cookware evaporates as the meat roasts. Carefully pour in more liquid if required.

Grilling flat items

Flat pieces of poultry, meat and fish, such as steaks, drumsticks and burgers, can be cooked effectively using the "Grill" heating function. It is also excellent for toasting bread.

Grilling

Keep the appliance door closed when using the grill. Never grill with the appliance door open.

Place the food to be grilled on the wire rack. In addition, slide the universal pan in at least one shelf position lower, with the slanted edge facing the appliance door. Any dripping fat will be caught.

When grilling, try wherever possible to use pieces of food which are of a similar thickness and weight. This will allow them to brown evenly and remain succulent and juicy. Place the food to be grilled directly onto the wire rack.

Use tongs to turn the pieces of food you are grilling. If you pierce the meat with a fork, the juices will run out and it will become dry.

Do not add salt to the meat until it has been grilled. Salt draws water from the meat.

Notes

- The grill element switches itself continuously on and off; this is normal. The set temperature determines how frequently this occurs.
- Smoke may be produced when grilling.

Meat thermometer

Depending on your appliance's features, you may have a meat thermometer. You can cook accurately using a meat thermometer. Read important notes on using the meat thermometer in the corresponding chapter. There, you can find notes on inserting the meat thermometer, the possible heating types and additional information.

Recommended setting values

The table lists values for poultry, meat and fish, with default values for the weight.

The setting values are based on the assumption that unstuffed, chilled, ready-to-roast poultry, meat or fish is placed into a cold cooking compartment.

If you wish to cook heavier poultry, meat or fish, always use the lower temperature. If cooking more than one item, use the weight of the heaviest item as a basis for determining the cooking time. The individual pieces should be approximately the same size.

As a general rule: The larger the poultry, meat or fish, the lower the cooking temperature and the longer the cooking time.

Turn the poultry, meat or fish after approx. $\frac{1}{2}$ to $\frac{2}{3}$ of the time listed.

Cover the bottom of the glass cookware with approx. 1/2 cm of liquid.

The quantity of liquid depends on the type of meat, the material the cookware is made from and on whether or not a lid is used. If you are cooking meat in an enamelled or dark-coloured metal roasting dish, it will need a little more liquid than if cooked in glass cookware.

Calculating the cooking time (e.g. 20+35):

To calculate the cooking time, assume 20 minutes per 500 g of meat plus an extra 35 minutes. For 1.5 kg, the cooking time would therefore be 95 minutes.

Cooking time range (e.g. 10-15):

Your food will be ready within the specified range of time (in minutes).

Roasting, braising and grilling

Roasting and Braising

Food	Dish	Shelf position	Type of heating	Temperature in °C	Time in minutes
Slow roast joint (beef)	Cookware, uncovered	2		140	50+50
Beef top side / top rump	Cookware, uncovered	2		170	40+30
Lamb leg (bone-in)	Cookware, uncovered	2		160-170	25+15
Lamb shoulder (bone-in)	Cookware, uncovered	2		160-170	15+25
Lamb shoulder (boned and rolled)	Cookware, uncovered	2		170-180	18+30
Rack of lamb**	Cookware, uncovered	2		170-190*	15+20
Pork, roast joint	Cookware, uncovered	2		180-190	30+35
Pork, loin joint	Cookware, uncovered	2		160	35+30
				<i>int</i> /	3-5
Pork, belly	Cookware, uncovered	2		170-180***	30+30
				250	3-5
Pork, gammon joint	Cookware, uncovered	2		160-170***	30+30
Chicken, whole	Wire rack*****	2		170-180	25+15
Chicken portion, bone-in, 200-250 g each	Cookware, uncovered	2		200-220	40-50
Duck, 2-3 kg	Cookware, uncovered	2		180-190	25+20
Turkey, crown	Wire rack	2		140-150****	20+25
Turkey, thighs	Cookware, uncovered	2		180-190	40+25
Turkey, whole, 4-8 kg	Wire rack	1		150-160*****	12+12
Fish, braised, whole 300 g, e.g. trout	Cookware, covered	2		170-190	25-35
Fish, braised, whole 1,5 kg, e.g. salmon	Cookware, covered	2		180-200	55-65
Fish fillet, plain, braised, 400 g	Cookware, covered	2		170-190	30-40
Meat loaf	Cookware, uncovered	2		170-180	20+40
Diced meat (beef, pork, lamb), 500 g meat	Cookware, covered	2		140	120-140
Diced chicken (boned), 500 g meat	Cookware, covered	2		140	100-120
Braising steak	Cookware, covered	2		140	100-120
Complete meal with beef	Wire rack + wire rack + universal pan	4+1		160, then 200 (yorkshire pudding)	beef: (20+15) + 20 for yorkshire pudding
Complete meal with chicken	Wire rack + wire rack + universal pan	4+1		180, then 200 (yorkshire pudding)	chicken: (25+25) + 20 for yorkshire pudding

* Preheat
 ** Without fat layer (best end neck), do not turn
 *** Do not turn
 **** Bone side down, do not turn
 ***** Turn after app. 1 hour
 ***** Slide in the universal pan underneath the wire rack

Grilling

Food	Dish	Shelf position	Type of heating	Grill setting	Time in minutes
Beef steak, height 2-3cm, medium	Wire rack	3		<i>int</i> /	1. side 11-13 2. side 4-6

* Preheat for 3 mins
 ** Preheat for 5 mins; do not use rapid heat-up function
 *** Slide the universal pan in underneath at shelf position 2
 **** Turn over several times

Food	Dish	Shelf position	Type of heating	Grill setting	Time in minutes
Beef burger, height 1-2cm	Wire rack	4		<i>Int/</i> *	1. side 8-9 2. side 4-5
Lamb chops, height 1-2cm	Wire rack	3		<i>Int/</i> **	1. side 5-6 2. side 5-6
Bacon rashers	Wire rack***	3		<i>Int/</i> **	1. side 4-5 2. side 3-4
Sausages, thickness 2-4cm	Wire rack	3		<i>Int/</i> *	10-15****
Fish fillets/chops	Wire rack	4		<i>Int/</i> *	12-16
Grilling white bread	Wire rack	4		<i>Int/</i> **	0-1

* Preheat for 3 mins
 ** Preheat for 5 mins; do not use rapid heat-up function
 *** Slide the universal pan in underneath at shelf position 2
 **** Turn over several times

Food	Dish	Shelf position	Type of heating	Temperature in °C	Time in minutes
Beef, top side / top rump	Cookware, uncovered	2		160	40+35
Lamb, leg (bone-in)	Cookware, uncovered	2		160-170	25+15
Lamb, shoulder (bone-in)	Cookware, uncovered	2		170-180	15+15
Lamb, shoulder (boned and rolled)	Cookware, uncovered	2		160-170	20+15
Rack of lamb**	Cookware, uncovered	2		170-190*	15+25
Pork, roast joint	Cookware, uncovered	2		180-200	30+40
Pork, loin joint	Cookware, uncovered	3		160-170***	35+35
Pork, belly	Cookware, uncovered	2		160-170***	30+30
Pork, gammon joint	Cookware, uncovered	2		170-180***	25+20
Chicken drumstick, 150 g each	Cookware, uncovered	3		210-230	30-40
Chicken portion, bone-in, 200-250 g each	Cookware, uncovered	3		200-220	35-45
Chicken, whole	Wire rack****	2		170-180	25+20
Duck, 2-3 kg	Cookware, uncovered	2		190-200	20+20
Turkey, thighs	Cookware, uncovered	2		160-170	35+30
Trout, whole, 300 g each	Wire rack	2		160-180	20-30

* Preheat
 ** Without fat layer (best end neck), do not turn
 *** Do not turn
 **** Slide in the universal pan underneath the wire rack

Steam- assisted roasting, braising and grilling

Certain foodstuffs become crispier during steam-assisted cooking. Their surface becomes glossier and they dry out less.

Use cookware without a lid. Cookware must be heat- and steam-resistant.

The roast does not have to be turned.

Use steam-assisted cooking if it is indicated in the table. Some dishes turn out best if they are cooked in several stages. These are indicated in the table.

Food	Dish	Shelf position	Type of heating	Temperature in °C	Steam intensity	Time in minutes
Slow roast joint (beef), 1,5 kg	Wire rack	2		140	low	30
					-	150-160
Beef top side / top rump, 1,5 kg	Cookware, uncovered	2		180-200	low	40
					-	10-20

Food	Dish	Shelf position	Type of heating	Temperature in °C	Steam intensity	Time in minutes		
Lamb leg (bone-in), 1,5 kg	Wire rack	2		180-190	low	30		
						-		
Rack of lamb (each 700 g)	Wire rack	2		200	low	20		
						160-170		
Pork, roast joint, 1,5 kg	Cookware, uncovered	2		160-170	low	40		
						-		
Pork, loin joint, 1,5 kg	Cookware, uncovered	2		170-180	low	40		
						-		
Pork, gammon joint, 1,5 kg	Cookware, uncovered	2		170-180	low	30		
						-		
Pork, belly, 1 kg	Cookware, uncovered	2		160-170	low	30		
						-		
Chicken, whole, 1,5 kg	Cookware, uncovered	2		170-180	low	30		
						-		
Chicken drumstick (each 150 g)	Wire rack	3		200-210	low	30-40		
Chicken portion (each 200-250 g)	Wire rack	2		200-220	low	20		
						-		
Duck, 2-3 kg	Wire rack	2		160-170	low	30-40		
							-	30-40
							-	30-40
Turkey, crown, 3 kg	Wire rack	2		140-150	low	35		
						-		
Turkey, whole, 7 kg	Wire rack	1		140-150	low	40		
						140-150	-	80-110
						170-180	-	30-40
Meat loaf, 1 kg	Cookware, uncovered	2		170-180	low	40		
						-		

Ready meals

Here, you will find the ideal settings for preparing chilled and frozen meals.

Notes

- The cooking result greatly depends on the quality of the food. Pre-browning and irregularities are sometimes already present on the raw product.
- Do not use frozen products that are covered with a thick layer of ice. Remove any ice on the food.
- Distribute foods that are in the form of separate pieces, such as bread rolls and potato products, so that they are spread out flat and evenly on the accessory. Leave a little space between the individual pieces.
- Follow the manufacturer's instructions on the packaging.

Shelf positions

Use the shelf positions indicated.

Baking on one level

When baking on one level, use the following shelf positions:

- Tall baked items: Position 2
- Flat baked items: Position 3

Baking on two levels

Use CircoTherm hot air. Items that are placed in the oven on baking trays or in baking tins/dishes at the same time will not necessarily be ready at the same time.















- Universal pan: Position 3
Baking tray: Position 1

Recommended setting values

The table lists the optimal heating function for various types of food. The temperature and cooking time depend on the amount and consistency of the dough/mixture. Settings ranges are specified for this reason. Try using the lower values to start with. A lower temperature will result in more even browning. You can use a higher setting next time if necessary.

The baking tins must be resistant to heat and steam for preparing with steam-assisted cooking.

Baking

Food	Dish	Shelf position	Type of heating	Temperature in °C	Steam intensity	Time in minutes
Pizza, chilled	Wire rack	3		190-210	-	15-20
Pizza, frozen, thin base	Wire rack	3		210-230	-	15-20
Pizza, frozen, thin base, 2 levels	Universal pan + wire rack	3+1		190-210	-	20-25
Pizza, frozen, thick base	Wire rack	3		180-200	-	20-25
Pizza, frozen, thick base, 2 levels	Universal pan + wire rack	3+1		190-210	-	20-30
Oven chips, Croquettes, frozen	Universal pan	3		190-210	-	25-35
Oven chips, frozen, 2 levels	Universal pan + baking tray	3+1		190-210	-	30-40
Hash browns, frozen	Universal pan	2		210-230	-	30-40
Fish fingers, frozen	Universal pan	3		200-220	-	20-25
Chicken nuggets, frozen	Universal pan	3		190-210	-	20-25
Lasagna, chilled, 500 g	Ovenproof dish on wire rack	2		180-190	low	20
					-	10-20
Lasagna, chilled, 1,5 kg	Ovenproof dish on wire rack	2		160-170	low	30
					-	10-20
Lasagna, frozen, 500 g	Ovenproof dish on wire rack	2		180-190	low	20
					-	20-30
Lasagna, frozen, 1,5 kg	Ovenproof dish on wire rack	2		160-170	low	30
					-	20-30

Desserts

You can make your own soufflés and yogurt using your appliance.



Soufflés

You can also prepare soufflés in a water bath in the universal pan. To do so, slide the universal pan in at level 2.

Yogurt

Remove accessories and shelves from the cooking compartment. The cooking compartment must be empty.

1. Heat 1 litre of milk (3.5 % fat) to 90 °C on the hob and then cool down to 40 °C.
It is sufficient to heat UHT milk to 40 °C.
2. Stir in 150 g (chilled) yogurt.
3. Pour into cups or small jars and cover with cling film.
4. Place the cups or jars onto the cooking compartment floor and set as indicated in the table.
5. After preparation, leave the yogurt to cool in the refrigerator.

Dish	Accessories/cookware	Shelf position	Type of heating	Temperature in °C	Cooking time in mins
Yoghurt	Individual moulds	Cooking compartment floor		40-45	8-9h
Soufflé in individual moulds	Individual moulds	2		160-180	35-45

Acrylamide in foodstuffs

Acrylamide is mainly produced in grain and potato products prepared at high temperatures, such as potato

crisps, chips, sliced bread, bread rolls, bread or fine baked goods (biscuits, gingerbread, spiced biscuit).

Tips for keeping acrylamide to a minimum

General	<ul style="list-style-type: none"> ■ Keep cooking times as short as possible. ■ Cook food until it is golden brown, but not too dark. ■ Large, thick pieces of food contain less acrylamide.
Baking	<p>With top/bottom heating at max. 200 °C. With hot air at max. 180 °C.</p>

Tips for keeping acrylamide to a minimum	
Biscuits	With top/bottom heating at max. 190 °C. With hot air at max. 170 °C. Egg or egg yolk reduces the production of acrylamide.
Oven chips	Spread out a single layer evenly on the baking tray. Cook approx. 400-600 g at once on a baking tray so that the chips do not dry out and become crunchy.

Drying

You can achieve outstanding drying results with CircoTherm. With this type of preserving, flavours are concentrated as a result of the dehydration.

Only use unblemished, fresh fruit, vegetables and herbs and wash them thoroughly. Line the wire rack with greaseproof paper or parchment paper. Drain the excess water from the fruit and then dry it.

If necessary, cut it into equal chunks or thin slices. Place unpeeled fruit onto the dish with the sliced surfaces facing upwards. Ensure that neither fruit nor mushrooms overlap on the wire rack.

Grate vegetables and then blanch them. Drain the blanched vegetables thoroughly and spread them evenly on the wire rack.

Dry herbs on the stem. Position the herbs evenly and slightly heaped on the wire rack.





Use the following shelf positions for drying:

- 1 wire rack: Level 3
- 2 wire racks: Levels 3 + 1

Turn very juicy fruit and vegetables several times. After drying, remove the dried fruit and vegetables from the paper immediately.

In the table, you will find settings for drying various foodstuffs. The temperature and drying time are dependent on the type, moisture, ripeness and thickness of the food to be dried. The longer you leave the food to be dried, the better it will be preserved. The thinner the slices are, the quicker the drying process will be and the more flavour the dried food will retain. Settings ranges are indicated for this reason.

If you wish to dry food that is not listed in the table, you should use similar foodstuffs in the table as a reference.

Fruit, vegetables and herbs	Accessories	Heating function	Temperature in °C	Cooking time in hours
Pomes (apple rings, 3 mm thick, 200 g per wire rack)	1-2 wire racks		80	4-8
Root vegetables (carrots), grated, blanched	1-2 wire racks		80	4-7
Sliced mushrooms	1-2 wire racks		80	5-8
Herbs, prepared	1-2 wire racks		60	2-5

Preserving

You can preserve fruit and vegetables using your appliance.

Warning – Risk of injury!

If the food is preserved incorrectly, the preserving jars may burst. Follow the instructions for preserving.

Jars

Only use clean and undamaged preserving jars. Only use heat-resistant, clean and undamaged rubber rings. Check clips and clamps in advance.

For each preserving process, only use preserving jars that are the same size and contain the same food. In the cooking compartment, you can preserve the contents of a maximum of six ½, 1 or 1½-litre preserving jars at the same time. Do not use jars that are larger or taller than this. The lids could rupture.

Preserving jars must not touch one another in the cooking compartment during the preserving process.

Preparing fruit and vegetables

Only use fruit and vegetables that are in good condition. Wash them thoroughly.

Peel, core and chop fruit and vegetables appropriate to their type and fill the preserving jars with them up to approx. 2 cm below the rim.

Fruit: Fill the preserving jars with the fruit along with a hot, skimmed sugar solution (approx. 400 ml for a 1-litre jar). For one litre of water:

- Approx. 250 g sugar for sweet fruit
- Approx. 500 g sugar for sour fruit

Vegetables: Fill the jars with the vegetables along with hot, boiled water.

Wipe the rims of the jars, as they must be clean. Place a damp rubber ring and a lid on each jar. Seal the jars with the clips. Place the jars into the universal pan so that they do not touch each other. Pour 500 ml hot water (approx. 80 °C) into the universal pan. Use the settings indicated in the table.

Ending the preserving process





Fruit: After a short while, small bubbles will form at short intervals. Switch off the appliance once all preserving jars are bubbling. Remove the jars from the cooking compartment after the indicated residual heating time.

Vegetables: After a short while, small bubbles will form at short intervals. As soon as all preserving jars are bubbling, reduce the temperature to 120 °C and allow the jars to continue to bubble in the closed cooking compartment as indicated in the table. After this time has elapsed, switch off the appliance and make use of the residual heat for several minutes as indicated in the table.

After preserving, remove the jars from the cooking compartment and place them onto a clean cloth. Do not place these hot jars onto a cold or damp surface, as they may crack. Cover the preserving jars to protect

them from draughts. Only remove the clamps once the jars are cold.

The indicated times in the settings table are average values for preserving fruit and vegetables. They may be influenced by room temperature, the number of jars, quantity, heat and quality of the jar contents. The specifications are based on 1-litre round jars. Before you switch off the appliance or change the cooking mode, check whether the contents of the jars are bubbling as they should. The bubbling process starts after approx. 30-60 minutes.

Meal	Accessory/cookware	Shelf position	Type of heating	Step	Temperature in °C	Cooking time in mins
Vegetables, e.g. carrots	1-litre preserving jars	1		1.	160-170	Before it starts bubbling: 30-40
				2.	120	Once it starts bubbling: 30-40
				3.	-	Residual heat: 30
Vegetables, e.g. cucumbers	1-litre preserving jars	1		1.	160-170	Before it starts bubbling: 30-40
				2.	-	Residual heat: 30
Stone fruit, e.g. cherries, damsons	1-litre preserving jars	1		1.	160-170	Before it starts bubbling: 30-40
				2.	-	Residual heat: 35
Pomes, e.g. apples, strawberries	1-litre preserving jars	1		1.	160-170	Before it starts bubbling: 30-40
				2.	-	Residual heat: 25

Prove dough

Your yeast dough will prove considerably more quickly using this heating function than at room temperature and will not dry out. Do not start the appliance if the cooking compartment is not completely cool.

Always allow yeast dough to prove twice. Use the settings indicated in the settings tables for the first and second proving stages (dough fermentation stage and final fermentation stage).

Dough fermentation

Place the dough into a heat-resistant bowl and place this onto the wire rack. Use the settings indicated in the table.

Do not open the appliance door while the dough is proving, otherwise moisture will escape. Do not cover the dough.





Condensation builds up during the proving process, which steams up the door panel. Wipe out the cooking compartment after dough proving. Remove any limescale with a little vinegar and wipe with clean water.

Final fermentation

Place your dough into the oven at the shelf position indicated in the table.

If you want to preheat the oven, the final fermentation stage takes place outside the appliance in a warm place.

The temperature and proving time are dependent on the type and quantity of the ingredients. For this reason, the values indicated in the settings table are intended as a guide only.

Dish	Accessories/cookware	Shelf position	Type of heating	Step	Temperature in °C	Cooking time in mins
Yeast dough, light	Bowl	2		1.	35-40	25-30
	Baking tray	2		2.	35-40	10-20
Yeast dough, heavy and rich	Bowl	2		1.	35-40	60-75
	Heat-resistant cookware	2		2.	35-40	45-60



Defrosting

For defrosting frozen fruit, vegetables and baked items. Poultry, meat and fish should ideally be defrosted in the refrigerator. Not suitable for cream cakes or cream gateaux.

Use the following shelf positions when defrosting:

- 1 wire rack: Position 2
- 2 wire racks: Positions 3 + 1

The times indicated in the table are intended as a guide only. They are dependent on the quality, freezing temperature (-18 °C) and composition of the food. Time ranges are indicated. Set the shortest time to begin with, and then extend the time if necessary.

Dish	Accessories/cookware	Shelf position	Heating function	Temperature in °C	Cooking time in mins
Bread, general	Baking tray	2		50	40-70
Cake, moist	Baking tray	2		50	70-90
Cake, dry	Baking tray	2		60	60-75

Keeping warm

You can keep cooked dishes warm using the top/bottom heating type at 70 °C. This will avoid condensation developing, and means you will not have to wipe out the cooking compartment.

Do not keep cooked dishes warm for longer than two hours. Be aware that some dishes may continue cooking whilst being kept warm. Cover the dishes if necessary.

Test dishes

These tables have been produced for test institutes to facilitate appliance testing.

As per EN 60350-1.

Baking

Baked items that are placed into the oven on trays or in baking tins/dishes at the same time will not necessarily be ready at the same time.

Shelf positions for baking on two levels:

- Universal pan: Level 3
- Baking tray: Level 1
- Baking tins/dishes on the wire rack
- First wire rack: Level 3
- Second wire rack: Level 1

Shelf positions for baking on three levels:

- Baking tray: Level 4
- Universal pan: Level 3
- Baking tray: Level 1

Tip: Food that has been frozen in thinner pieces or in portions defrosts more quickly than food items frozen in a block.

Remove frozen food from its packaging and place it onto the wire rack in suitable cookware.

Redistribute the food or turn it once or twice as it defrosts. Large pieces of food should be turned several times. As the food defrosts, break up any clumps and remove items which have already defrosted from the cooking compartment.

To allow the temperature to equalise, leave the defrosted food to rest for another 10 to 30 minutes in the appliance after switching it off.

Baking with two springform tins:

- On one level (figure 1)
- On two levels (figure 2)

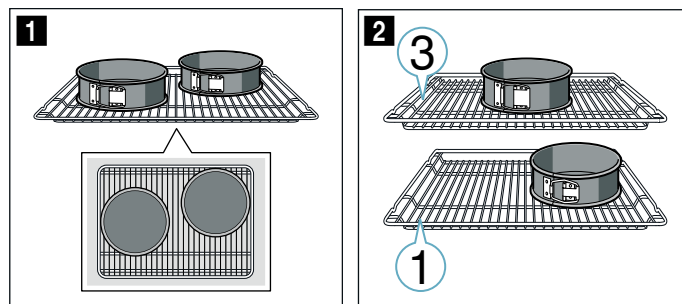

Notes

- The setting values apply to dishes placed into a cold cooking compartment.
- Please note the information in the tables about preheating. The setting values are valid without rapid heating-up.
- For baking, use the lower of the indicated temperatures first.

Grilling

Also slide in the universal pan. The liquid will be caught and the cooking compartment stays cleaner.

Steam-assisted baking

Certain foodstuffs become crispier during steam-assisted cooking. Their surface becomes glossier and they dry out less.

Steam-assisted baking is only possible on one level.

The baking tins must be resistant to heat and steam for preparing with steam-assisted cooking.

Baking

Meal	Accessories/cookware	Shelf position	Type of heating	Temperature in °C	Steam intensity	Cooking time in mins
Piped cookies	Baking tray	3	≡	140-150*	-	25-35
Piped cookies	Baking tray	3	⌒	140-150*	-	20-30
Viennese whirls, 2 levels	Universal pan + baking tray	3+1	⌒	140-150*	-	25-35
Viennese whirls, 3 levels	Baking trays + universal pan	4+3+1	⌒	130-140*	-	35-55
Small cakes	Baking tray	3	≡	150*	-	25-35
Small cakes	Baking tray	3	⌒	150*	-	20-30
Small cakes, 2 levels	Universal pan + baking tray	3+1	⌒	140*	-	25-35
Small cakes, 3 levels	Baking trays + universal pan	4+3+1	⌒	140*	-	25-35
Hot water sponge cake	Springform cake tin, 26 cm diameter	2	≡	160-170**	-	25-35
Hot water sponge cake	Springform cake tin, 26 cm diameter	2	⌒	150-160	low	30-35
Hot water sponge cake, 2 levels	2 x 26 cm springform cake tins	3+1	⌒	150-160**	-	35-50
Double-crust ed apple pie	Black cake tin, 20 cm diameter	2	⌒	160-170	-	70-90
Double-crust ed apple pie	Black cake tin, 20 cm diameter	1	≡	190-210	-	70-80
Double-crust ed apple pie, 2 levels	2 x 20 cm black cake tins	3+1	⌒	160-180	-	70-90
* Preheat for 5 mins; do not use rapid heat-up function						
** Preheat; do not use rapid heat-up function						

Grilling

Dish	Accessories	Shelf position	Heating function	Temperature in °C	Cooking time in mins
Toast*	Wire rack	4	⚡	<i>int</i>	5-6
Beefburgers, x 12**	Wire rack	4	⚡	<i>int</i>	25-30
* Do not preheat					
** Turn after 2/3 of the total time					



A series of horizontal lines for writing, consisting of 18 evenly spaced lines extending across the width of the page.



REGISTER YOUR PRODUCT
ONLINE NEFF-HOME.COM



Constructa NEFF Vertriebs-GmbH |
Carl-Wery-Straße 34 | 81739 Munich | Germany

9001437040
990115
en