



Oven

[en] User manual and installation instructions

C17FS32.0B



# Table of contents

## USER MANUAL

1	Safety .....	2
2	Preventing material damage .....	4
3	Environmental protection and saving energy .....	5
4	Familiarising yourself with your appliance .....	6
5	Accessories.....	9
6	Before using for the first time .....	11
7	Basic operation .....	12
8	Steam .....	13
9	Time-setting options.....	17
10	Baking and roasting assistant .....	18
11	Steam programs.....	19
12	Childproof lock.....	20
13	Rapid heat-up .....	20
14	Sabbath mode .....	21
15	Basic settings.....	21
16	Home Connect .....	22
17	Cleaning and servicing.....	24
18	Cleaning functions.....	26
19	Rails .....	29
20	Appliance door.....	29
21	Troubleshooting.....	32
22	Disposal.....	35
23	Customer Service.....	35
24	Declaration of Conformity .....	36
25	How it works.....	36
26	INSTALLATION INSTRUCTIONS .....	44
26.1	General installation instructions.....	44

## 1 Safety

Observe the following safety instructions.

### 1.1 General information

- Read this instruction manual carefully.

- Keep the instruction manual and the product information safe for future reference or for the next owner.
- Do not connect the appliance if it has been damaged in transit.

### 1.2 Intended use

This appliance is designed only to be built into kitchen units. Read the special installation instructions.

Only a licensed professional may connect appliances without plugs. Damage caused by incorrect connection is not covered under the warranty.

Only use this appliance:

- To prepare meals and drinks.
- In private households and in enclosed spaces in a domestic environment.
- Up to an altitude of max. 2000 m above sea level.

### 1.3 Restriction on user group

This appliance may be used by children aged 8 or over and by people who have reduced physical, sensory or mental abilities or inadequate experience and/or knowledge, provided that they are supervised or have been instructed on how to use the appliance safely and have understood the resulting dangers.

Children must not play with the appliance. Children must not perform cleaning or user maintenance unless they are at least 15 years old and are being supervised.

Keep children under the age of 8 years away from the appliance and power cable.

### 1.4 Safe use

Always place accessories in the cooking compartment the right way round.

→ "Accessories", Page 9

#### **WARNING – Risk of fire!**

Combustible objects that are left in the cooking compartment may catch fire.

- ▶ Never store combustible objects in the cooking compartment.
- ▶ If smoke is emitted, the appliance must be switched off or the plug must be pulled out and the door must be held closed in order to stifle any flames.

Loose food remnants, fat and meat juices may catch fire.

- ▶ Before using the appliance, remove the worst of the food residues and remnants from the cooking compartment, heating elements and accessories.

Opening the appliance door creates a draught. Greaseproof paper may come into contact with the heating element and catch fire.

- ▶ Never place greaseproof paper loosely over accessories when preheating the appliance and while cooking.
- ▶ Always cut greaseproof paper to size and use a plate or baking tin to hold it down.

### **⚠ WARNING – Risk of burns!**

The appliance and its parts that can be touched become hot during use.

- ▶ Caution should be exercised here in order to avoid touching heating elements.
- ▶ Young children under 8 years of age must be kept away from the appliance.

Accessories and cookware get very hot.

- ▶ Always use oven gloves to remove accessories or cookware from the cooking compartment.

When the cooking compartment is hot, any alcoholic vapours inside may catch fire.

- ▶ Only use small quantities of drinks with a high alcohol content in food.
- ▶ Open the appliance door carefully.

### **⚠ WARNING – Risk of scalding!**

The accessible parts of the appliance become hot during operation.

- ▶ Never touch these hot parts.
- ▶ Keep children at a safe distance.

Hot steam may escape when you open the appliance door. Steam may not be visible, depending on the temperature.

- ▶ Open the appliance door carefully.
- ▶ Keep children at a safe distance.

If there is water in the cooking compartment when it is hot, this may create hot steam.

- ▶ Never pour water into the cooking compartment when the cooking compartment is hot.

### **⚠ WARNING – Risk of injury!**

Scratched glass in the appliance door may develop into a crack.

- ▶ Do not use any harsh or abrasive cleaners or sharp metal scrapers to clean the glass on the oven door, as they may scratch the surface.

The hinges on the appliance door move when the door is opened and closed, which could trap your fingers.

- ▶ Keep your hands away from the hinges. Components inside the appliance door may have sharp edges.

- ▶ Wear protective gloves.

### **⚠ WARNING – Risk of electric shock!**

Incorrect repairs are dangerous.

- ▶ Repairs to the appliance should only be carried out by trained specialist staff.
- ▶ Only use genuine spare parts when repairing the appliance.
- ▶ If the power cord of this appliance is damaged, it must be replaced by trained specialist staff.

If the insulation of the power cord is damaged, this is dangerous.

- ▶ Never let the power cord come into contact with hot appliance parts or heat sources.
- ▶ Never let the power cord come into contact with sharp points or edges.
- ▶ Never kink, crush or modify the power cord.

An ingress of moisture can cause an electric shock.

- ▶ Do not use steam- or high-pressure cleaners to clean the appliance.

If the appliance or the power cord is damaged, this is dangerous.

- ▶ Never operate a damaged appliance.
- ▶ Never operate an appliance with a cracked or fractured surface.
- ▶ Never pull on the power cord to unplug the appliance. Always unplug the appliance at the mains.
- ▶ If the appliance or the power cord is damaged, immediately unplug the power cord or switch off the fuse in the fuse box.
- ▶ Call customer services. → Page 35

**⚠ WARNING – Danger: Magnetism!**

Permanent magnets are used in the control panel or in the controls. These may affect electronic implants, e.g. heart pacemakers or insulin pumps.

- ▶ Wearers of electronic implants must stay at least 10 cm away from the control panel.

**⚠ WARNING – Risk of suffocation!**

Children may put packaging material over their heads or wrap themselves up in it and suffocate.

- ▶ Keep packaging material away from children.
- ▶ Do not let children play with packaging material.

Children may breathe in or swallow small parts, causing them to suffocate.

- ▶ Keep small parts away from children.
- ▶ Do not let children play with small parts.

## 1.5 Steam

Follow these instructions when using a steam function.

**⚠ WARNING – Risk of scalding!**

The water in the water tank may become very hot if you operate the appliance for long periods.

- ▶ Always empty the water tank after using the steam function.

Hot steam is generated in the cooking compartment.

- ▶ Do not reach into the cooking compartment when using steam.

Hot liquid may spill over the sides of the accessory when it is removed from the cooking compartment.

- ▶ Remove hot accessories with care and always wear oven gloves.

**⚠ WARNING – Risk of fire!**

Due to the hot surfaces, vapours from flammable liquids may catch fire in the cooking compartment (explosion). The appliance door may spring open. Hot steam and jets of flame may escape.

- ▶ Do not pour flammable liquids (e.g. alcoholic drinks) into the water tank.
- ▶ Only fill the water tank with water or with the descaling solution we have recommended.

## 1.6 Cleaning function

**⚠ WARNING – Risk of burns!**

⚠ The outside of the appliance gets very hot when the cleaning function is in progress.

- ▶ Never touch the appliance door.
- ▶ Allow the appliance to cool down.
- ▶ Keep children at a safe distance.

---

# 2 Preventing material damage

## 2.1 General

**ATTENTION!**

Objects on the cooking compartment floor at over 50 °C will cause heat to build up. The baking and roasting times will no longer be correct and the enamel will be damaged.

- ▶ Do not place any accessories, greaseproof paper or foil of any kind on the cooking compartment floor.
- ▶ Only place cookware on the cooking compartment floor if a temperature above 50 °C has been set.

When the cooking compartment is hot, any water inside it will create steam. The change in temperature may cause damage.

- ▶ Never pour water into the cooking compartment when it is still hot.
- ▶ Never place cookware containing water on the cooking compartment floor.

The prolonged presence of moisture in the cooking compartment leads to corrosion.

- ▶ Allow the cooking compartment to dry after use.
- ▶ Do not keep moist food in the cooking compartment for a long time with the door closed.
- ▶ Do not store food in the cooking compartment.

Leaving the appliance to cool down with the door open will damage the front of neighbouring kitchen units over time.

- ▶ Always allow the cooking compartment to cool down with the door closed after cooking at high temperatures.
- ▶ Take care not to trap anything in the appliance door.
- ▶ Only leave the cooking compartment to dry with the door open if a lot of moisture was produced during operation.

Fruit juice dripping from the baking tray leaves stains that cannot be removed.

- ▶ When baking very juicy fruit flans, do not pack too much on the baking tray.
- ▶ If possible, use the deeper universal pan.

Using oven cleaner in a hot cooking compartment damages the enamel.

- ▶ Never use oven cleaner in the cooking compartment when it is still warm.
- ▶ Remove all food remnants from the cooking compartment and the appliance door before you next heat up the appliance.

If the seal is very dirty, the appliance door will no longer close properly during operation. This may damage the front of adjacent kitchen units.

- ▶ Keep the seal clean at all times.
- ▶ Never operate the appliance if the seal is damaged or missing.

Sitting or placing objects on the appliance door may damage it.

- ▶ Do not place or hang objects on the appliance door.
- ▶ Do not place cookware or accessories on the appliance door.

With certain models, accessories may scratch the door pane when closing the appliance door.

- ▶ Always push accessories fully into the cooking compartment.

## 2.2 Steam

Follow these instructions when using the steam function.

### ATTENTION!

Silicone bakeware is not suitable for combined operation with steam.

- ▶ Cookware must be heat- and steam-resistant.

Using cookware with rust spots may cause corrosion in the cooking compartment. Even the smallest spots of rust can cause corrosion.

- ▶ Do not use cookware with rust spots.

Dripping liquids make the cooking compartment floor dirty.

- ▶ When steaming with a perforated cooking container, always place the baking tray, the universal pan or the unperforated cooking container underneath. This will catch any liquid that drips down.

Hot water in the water tank may damage the steam system.

- ▶ Only fill the water tank with cold water.

If there is water on the cooking compartment floor when operating the appliance at temperatures above 120 °C, this will damage the enamel.

- ▶ Do not use the appliance if there is water on the cooking compartment floor.
- ▶ Wipe away any water on the cooking compartment floor before operation.

If descaling solution comes into contact with the control panel or other delicate surfaces, it will damage them.

- ▶ Remove descaling solution immediately with water. Cleaning the water tank in the dishwasher will damage it.

- ▶ Do not clean the water tank in the dishwasher.
- ▶ Clean the water tank with a soft cloth and standard washing-up liquid.

---

# 3 Environmental protection and saving energy

## 3.1 Disposing of packaging

The packaging materials are environmentally compatible and can be recycled.

- ▶ Sort the individual components by type and dispose of them separately.

## 3.2 Saving energy

If you follow these instructions, your appliance will use less power.

Only preheat the appliance if the recipe or the recommended settings tell you to do so.

- Not preheating the appliance can reduce the energy used by up to 20%.

Use dark-coloured, black-coated or enamelled baking tins.

- These types of baking tin absorb the heat particularly well.

Open the appliance door as little as possible during operation.

- This will maintain the temperature in the cooking compartment and eliminate the need for the appliance to reheat.

When baking multiple dishes, do so in succession or in parallel.

- The cooking compartment is heated after baking the first dish. This reduces the baking time for the second cake.

If the cooking time is relatively long, you can switch the appliance off 10 minutes before the cooking time ends.

- There will be enough residual heat to finish cooking the dish.

Remove any accessories that are not being used from the cooking compartment.

- Accessories that are not being used do not need to be heated.

Allow frozen food to defrost before cooking.

- This will save the energy that would otherwise be required to defrost it.

## 4 Familiarising yourself with your appliance

### 4.1 Control panel

You can use the control panel to configure all functions of your appliance and to obtain information about the operating status.

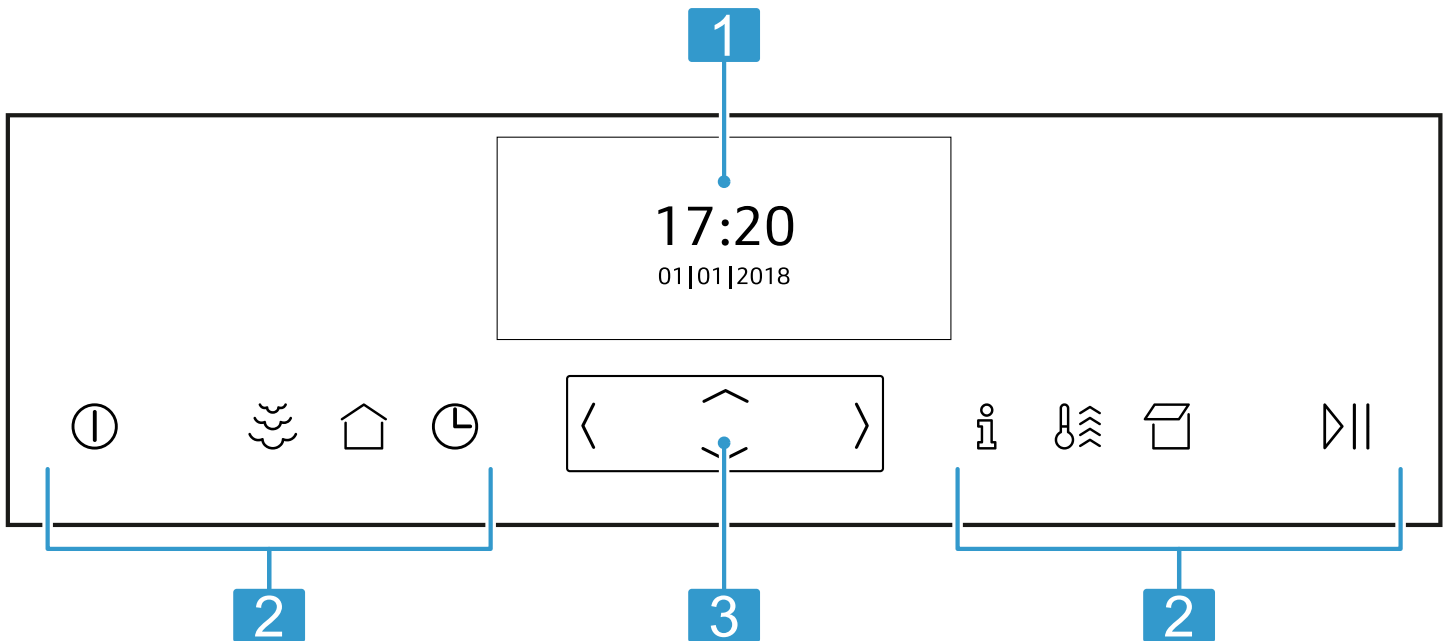

**1** Display

**2** Buttons

**3** Control element

### 4.2 Buttons

The buttons are touch-sensitive areas. To select a function, press the corresponding button.

Symbol	Name	Use
ⓘ	On/off	Switch the appliance on or off
☁	Steam assistance	Switch on steam assistance
🏠	Main menu	Select operating modes and settings
🕒	Time-setting options/ childproof lock	<ul style="list-style-type: none"> <li>Set the "timer", "cooking time" or "Ready at" time for delayed starts</li> <li>Activate or deactivate the "childproof lock"</li> </ul>
ℹ	Information	<ul style="list-style-type: none"> <li>View additional information</li> <li>View the current temperature</li> </ul>
🔥	Rapid heat-up	<ul style="list-style-type: none"> <li>Activate or deactivate the "Rapid heat-up" function</li> <li>Activate or deactivate the "PowerBoost" function</li> </ul>
📦	Open control panel	Fill or empty the water tank
▶	Start/stop	Start or pause the appliance

### 4.3 Control element

You can configure all the functions on your appliance using the control element. You can change the setting values that are displayed more brightly.











Press and hold a button to scroll through the setting values quickly. Release the button to stop scrolling quickly.

Button	Name	Use
<	Left	Navigate to the left on the display
>	Right	Navigate to the right on the display
^	Up	Navigate upwards on the display
v	Down	Navigate downwards on the display

## 4.4 Main menu









The main menu provides an overview of your appliance's functions.







Press the  button to open the main menu.

Function	Name	Use
	Heating functions	Select the required heating function and temperature for your food
	Steam	Cooking with steam
	Baking and roasting assistant	Recommended settings for baking and roasting
	Steam programs	Cooking food with steam
	MyProfile	Individually adjust the appliance settings
	Home Connect	Connect the oven to a mobile end device and remotely control it. → "Home Connect ", Page 22
	Descal	Descal the steam system
	Dry	Dry the cooking compartment after cooking with steam
	Floor cleaning aid	Clean less stubborn dirt from the cooking compartment floor
	EcoClean	Clean the cooking compartment

## 4.5 Heating functions

Here you will find an overview of the heating functions. You will find recommendations on using the heating functions. For temperatures above 275 °C, the appliance reduces the temperature to approx. 275 °C after approx. 40 minutes.

Symbol	Heating function	Temperature	Use
	CircoTherm hot air	40 - 200 °C	Bake or roast on one or more levels. The fan distributes the heat from the ring-shaped heating element in the back wall evenly around the cooking compartment.
	Top/bottom heating	50 - 275 °C	Traditionally bake or roast on one level. This heating function is ideal for cakes with moist toppings. The heat is emitted evenly from above and below.
	Circo-roasting	50 - 250 °C	Roast poultry, whole fish or large pieces of meat. The grill element and the fan switch on and off alternately. The fan circulates the hot air around the food.
	Pizza setting	50 - 275 °C	Cook pizza or food that requires a lot of heat from below. The bottom heating element and the ring-shaped heating element in the back wall heat the cooking compartment.
	Bread-baking setting	180 - 240 °C	For baking bread, bread rolls and baked goods that require high temperatures.
	Full-surface grill	50 - 290 °C	For grilling thin items such as steaks, sausages or bread and for browning food. The entire area below the grill element becomes hot.
	Centre-area grill	50 - 290 °C	For grilling small amounts of steaks, sausages or bread and for browning food. The central area underneath the grill element becomes hot.
	Bottom heating	50 - 250 °C	For cooking in a bain marie and for baking food for extra time. Heat is emitted from below.

Symbol	Heating function	Temperature	Use
	Slow cooking	70 - 120 °C	For gentle, slow cooking of seared, tender pieces of meat in ovenware without a lid. Heat is emitted evenly from above and below at a low temperature.
	Dough proving	2 settings	For proving dough and culturing yoghurt. Dough will prove more quickly than at room temperature. The surface of the dough will not dry out.
	Defrost	30 - 60 °C	For gently defrosting frozen food.
	Keep warm	60 - 100 °C	For keeping cooked food warm.
	Top/bottom heating eco	50 - 275 °C	For gently cooking selected types of food. Heat is emitted from above and below. This heating function is most effective between 150 and 250 °C. This heating function is used to measure the energy consumption in the standard mode.
	CircoTherm eco	40 - 200 °C	For gently cooking selected types of food on one level without preheating. The fan distributes the heat from the ring-shaped heating element in the back wall around the cooking compartment. This heating function is most effective between 125 and 200 °C. This heating function is used to measure the energy consumption in air recirculation mode and determine the energy efficiency class.
	Reheat	80 - 180 °C	For gently reheating food or for crisping up baked goods.

## 4.6 Cooking compartment

The functions in the cooking compartment make your appliance easier to use.

### Shelf supports

The rails in the cooking compartment enable you to place accessories at different heights.

→ "Accessories", Page 9

Your appliance has three shelf positions. The shelf positions are numbered from bottom to top.

You can remove the rails, e.g. for cleaning.

→ "Rails", Page 29

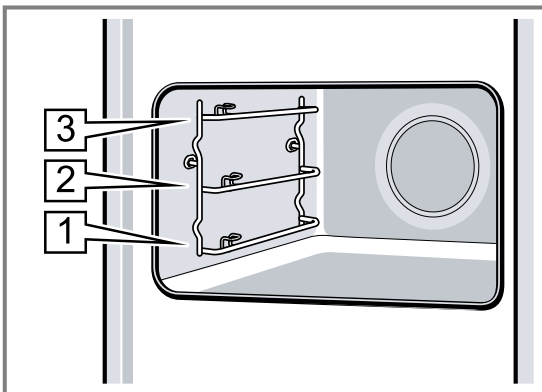

### Self-cleaning surfaces

The self-cleaning surfaces in the cooking compartment are coated with a porous, matt ceramic layer and have a rough surface. When the appliance is in operation, the self-cleaning surfaces absorb splashes from roasting or grilling and break them down.

The following surfaces are self-cleaning:

- Back wall

- Ceiling
- Side walls

Use the cleaning function regularly to help retain the cleaning ability of the self-cleaning surfaces and prevent damage.

→ "EcoClean cleaning function", Page 26

### Lighting

One or more oven lights illuminate the cooking compartment.

When you open the appliance door, the light in the cooking compartment switches on. If the appliance door remains open for longer than 15 minutes, the light switches off again.

For most operating modes, the lighting is switched on during operation. The lighting switches off again when the operation ends.

### Cooling fan

The cooling fan switches on and off depending on the appliance's temperature. The hot air escapes above the door.

#### ATTENTION!

Do not cover the ventilation slot above the appliance door. The appliance overheats.

- Ensure that the ventilation slots are unobstructed.

To ensure that the appliance cools down more quickly after operation, the cooling fan continues to run for a certain period afterwards.

### Appliance door

If you open the appliance door during operation, the operation stops. When you close the appliance door, the operation continues automatically.



## Water tank

You need the water tank for the types of steam heating. The water tank is behind the control panel.  
→ "Filling the water tank", Page 13

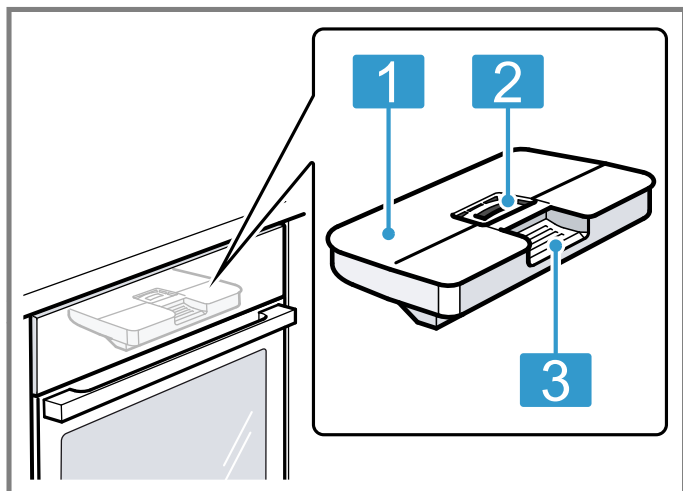

- |   |                                   |
|---|-----------------------------------|
| 1 | Tank cover                        |
| 2 | Opening for filling and emptying  |
| 3 | Handle for removing and inserting |

## 5 Accessories

Use original accessories. These have been made especially for your appliance.

**Note:** Accessories may become deformed if they get hot. Deformation has no effect on function. As the accessory cools down, it will regain its original shape.

The accessories supplied may differ depending on the appliance model.

### Accessories

Wire rack

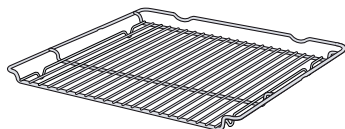

### Use

- Cake tins
- Ovenproof dishes
- Cookware
- Meat, e.g. roasting joints or steak
- Frozen meals

Universal pan

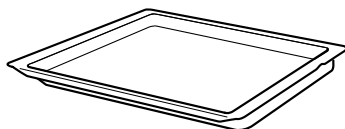

- Moist cakes
- Baked items
- Bread
- Large roasts
- Frozen meals
- Catch dripping liquids, e.g. fat when grilling food on the wire rack or water when cooking with steam.

Unperforated steam container, size S

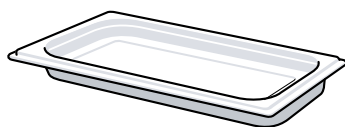

- Cooking:
- Rice
  - Pulses
  - Cereals
- Place the steam container on the wire rack.

Perforated steam container, size S

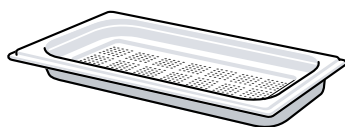

- Steaming vegetables.
  - Juicing berries.
  - Defrosting.
- Place the steam container on the wire rack.

Perforated steam container, size XL

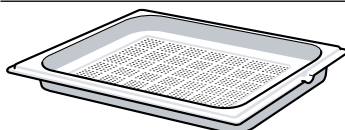

- Steaming large quantities of food.

## 5.1 Information on accessories

Some accessories are only suitable for certain types of heating.

### Steam container

The steam containers are suitable for steam-only types of heating up to 120 °C.

The steam containers are not suitable for higher temperatures or other types of heating. The containers become permanently discoloured and deformed.

## 5.2 Locking function

The locking function prevents the accessories from tilting when they are pulled out.

You can pull out the accessories approximately halfway without them tipping. The accessories must be inserted into the cooking compartment correctly for the tilt protection to work properly.

## 5.3 Sliding accessories into the cooking compartment

Always slide the accessory into the cooking compartment the right way round. This is the only way to ensure that accessories can be pulled out approximately halfway without tipping.

1. Turn the accessories so that the notch  is at the rear and is facing downwards.
2. Insert the accessory between the two guide rods for a shelf position.

Wire rack

Insert the wire rack with the open side facing the appliance door and the curved lip  facing downwards.

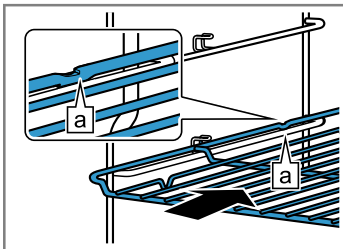

Baking tray  
E.g. universal pan or baking tray

Slide the tray in with the sloping edge  towards the appliance door.

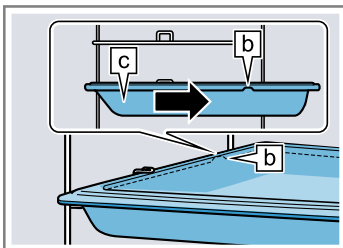

3. Push the accessory all the way in, making sure that it does not touch the appliance door.

**Note:** Take any accessories that you will not be using out of the cooking compartment while the appliance is in operation.

### Combining accessories

You can combine the wire rack with the universal pan to catch any liquid that drips down.

1. Place the wire rack on the universal pan so that both spacers  are on the rear edge of the universal pan.
2. Insert the universal pan between the two guide rods for a shelf position. In so doing, the wire rack is on top of the upper guide rod.

Wire rack  
on univer-  
sal pan

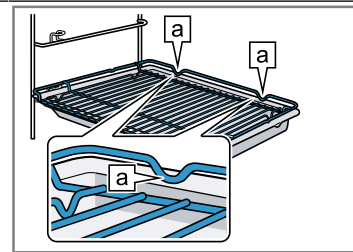

## 5.4 Other accessories

You can purchase other accessories from our after-sales service, specialist retailers or online.

You will find a comprehensive range of products for your appliance in our brochures and online: [www.neff-international.com](http://www.neff-international.com)

Accessories vary from one appliance to another. When purchasing accessories, always quote the exact product number (E no.) of your appliance.

You can find out which accessories are available for your appliance in our online shop or from our after-sales service.

## 6 Before using for the first time

Implement the settings for the initial configuration. Calibrate the appliance. Clean the appliance and accessories.

### 6.1 Before using for the first time

Before using the appliance for the first time, ask your water supplier about the hardness of your tap water. To ensure that the appliance can reliably remind you to descale it when required, you must set your water hardness range correctly.

#### ATTENTION!

If the wrong water hardness has been set, the appliance cannot remind you to descale it at the right time.

- ▶ Set the water hardness correctly.
- Using unsuitable liquids may damage the appliance.
- ▶ Do not use distilled water, highly chlorinated tap water (>40 mg/l) or other liquids.
- ▶ Only use cold, fresh tap water, softened water or non-carbonated mineral water.

Malfunctions may occur when using filtered or demineralised water. The appliance may request that you top up the water tank even though it may be full, or operation with steam is cancelled after approx. two minutes.

- ▶ If required, mix filtered or demineralised water with the bottled non-carbonated mineral water with a ratio of one to one.

**Tip:** If you use mineral water, set the water hardness range to "very hard". If you use mineral water, you must only use non-carbonated mineral water.

**Tip:** If your tap water is very hard, we recommend that you use softened water. If you use only softened water, you can set your appliance to the "softened" water hardness range.

Setting	Water hardness in mmol/l	German hardness in °dH	French hardness °fH
0 (softened) <sup>1</sup>	-	-	-
1 (soft)	Up to 1.5	Up to 8.4	Up to 15
2 (moderately hard)	1.5-2.5	8.4-14	15-25
3 (hard)	2.5-3.8	14-21.3	25-38
4 (very hard) <sup>2</sup>	Above 3.8	Above 21.3	Above 38

<sup>1</sup> Only set this if you will be using solely softened water.

<sup>2</sup> Also set for mineral water. Only use non-carbonated mineral water.

### 6.2 Initial use

When the appliance is connected to the power supply for the first time or following a lengthy power failure, the settings that you will need to configure before you can use it will appear.

#### Notes

- You can change these settings at any time by going to the basic settings.  
→ "Basic settings", Page 21
- You can also use Home Connect to configure the settings. If your appliance is connected, follow the instructions in the app.

#### Setting the language

1. Connect the appliance to the power supply.
- ✓ The first setting will appear after a few seconds.
2. Use the ∨ button to navigate to the bottom row.
3. Use the < or > button to select the language.
4. Use the ^ button to navigate back to the top row.
5. Use the > button to select the next setting.

#### Setting the time

1. Use the ∨ button to navigate to the bottom row.
2. Use the < or > button to select the correct hour.
3. Use the ∨ button to navigate to the next row.
4. Use the < or > button to select the correct number of minutes.
5. Use the ^ button to navigate back to the top row.
6. Use the > button to select the next setting.

#### Setting the date

1. Use the ∨ button to navigate to the next row.
2. Use the < or > button to select the correct day.
3. Use the ∨ button to navigate to the next row.
4. Use the < or > button to select the correct month.
5. Use the ∨ button to navigate to the next row.
6. Use the < or > button to select the correct year.
7. Press the ^ button repeatedly until "Date" appears.
8. Use the > button to apply the settings.

#### Setting the water hardness



1. Use the ∨ button to navigate to the bottom row.
2. Use the < or > button to select the water hardness range.  
→ "Before using for the first time", Page 11
3. Use the ^ button to navigate back to the top row.
4. Use the > button to save your settings.
5. Open and close the appliance door once.
- ✓ The appliance will perform a self-test, after which it will be ready to use.
- ✓ Initial configuration is now complete.

## 6.3 Calibrating and cleaning the appliance

You will need to calibrate the appliance and clean the cooking compartment and accessories before using it to cook food for the first time.

**Note:** The boiling point of water depends on the air pressure. During the calibration process, the appliance makes adjustments to adapt it to the pressure conditions in the location where it is installed.

**Requirement:** The cooking compartment must have cooled down completely.

1. Remove the product information, accessories and any leftover packaging (e.g. polystyrene pellets) from the cooking compartment.
2. Wipe the smooth surfaces in the cooking compartment with a soft, damp cloth.
3. Press  to switch the appliance on.  
→ "Switching on the appliance", Page 12
4. Fill the water tank.  
→ "Filling the water tank", Page 13
5. Set the required type of heating, temperature and cooking time for the calibration process and press  to start.  
→ "Steam", Page 14

### Calibration

Type of heating	Steam 
Temperature	100 °C
Duration	30 minutes

**Tip:** Do not open the appliance door while calibration is in progress. Calibration will otherwise be interrupted.

- ✓ Calibration starts. This generates a lot of steam.

## 6. ATTENTION!

If there is water on the cooking compartment floor when operating the appliance at temperatures above 120 °C, this will damage the enamel.

- ▶ Do not use the appliance if there is water on the cooking compartment floor.
- ▶ Wipe away any water on the cooking compartment floor before operation.

Allow the appliance to cool down and then wipe away the water from the cooking compartment floor.

7. Set the required type of heating and temperature for the heat-up process and press  to start.  
→ "Setting the type of heating and temperature", Page 12

### Heating up

Type of heating	CircoTherm hot air 
Temperature	Maximum
Duration	30 minutes

8. Ventilate the kitchen while the appliance is heating.
9. Press  to switch off the appliance after 30 minutes.  
→ "Switching off the appliance", Page 12
10. Allow the appliance to cool down.
11. Clean the smooth surfaces with soapy water and a dish cloth.
12. Empty the water tank and dry the cooking compartment.
13. Thoroughly clean any accessories you used with soapy water and a dish cloth.

**Note:** The appliance retains the calibration settings, even in the event of a power cut or disconnection from the mains.

**Tip:** To ensure that the calibration settings are updated to accommodate the conditions at the new location when you move house, restore the appliance's factory settings in the basic settings. Then repeat the calibration procedure.

→ "Basic settings", Page 21

# 7 Basic operation

## 7.1 Switching on the appliance

- ▶ Press  to switch the appliance on.

### Notes

- In the basic settings, you can specify whether the heating functions or the main menu should appear when you switch on the appliance.  
→ "Basic settings", Page 21
- If you do not perform any actions on the appliance for an extended period, it will automatically switch itself off.

## 7.2 Switching off the appliance

- ▶ Press  to switch the appliance off.

### Notes

- The residual heat indicator will appear on the display while the cooking compartment is still hot.  
→ "Residual heat indicator", Page 12



- The cooling fan will continue to run until the cooking compartment has cooled down.  
→ "Cooling fan", Page 8

## 7.3 Residual heat indicator

After you have switched off the appliance, the residual heat indicator will appear on the display.

Display	Temperature
Residual heat high	Over 120 °C
Residual heat low	Between 60 and 120 °C

## 7.4 Setting the type of heating and temperature

1. Press  to switch the appliance on.  
✓ The heating functions will then be displayed.
2. Use the  or  button to select the required heating function.



3. Use the  $\vee$  button to navigate to the next row.
4. Use the  $\langle$  or  $\rangle$  button to select the required temperature or setting.
5. Press  $\triangleright$  to start.
  - ✓ The cooking time will appear on the display.
  - ✓ The heat-up indicator bar visualises the rising temperature.
6. When the food is ready, press  $\odot$  to switch the appliance off.

## 7.5 Changing the temperature

You can also change the temperature once you have started the appliance.

1. Use the  $\wedge$  or  $\vee$  button to select the temperature row.
2. Use the  $\langle$  or  $\rangle$  button to select the required temperature.
- ✓ The temperature will now be changed.

## 7.6 Changing the type of heating

If you switch to a different heating function, the appliance will reset all the settings.

1. Press  $\triangleright$  to pause operation.
2. Use the  $\langle$  or  $\rangle$  button to select the required heating function.
3. Use the  $\vee$  button to navigate to the next row.
4. Use the  $\langle$  or  $\rangle$  button to select the required temperature.

5. Press  $\triangleright$  to start.

## 7.7 Pausing operation

1. Press  $\triangleright$ .
2. Press  $\triangleright$  again to resume operation.

## 7.8 Cancelling operation

**Note:** Some functions, e.g. cleaning functions, cannot be cancelled.

- ▶ Press and hold the  $\triangleright$  button until the function that is currently in progress is cancelled.
- ✓ Operation will stop and all the settings will be reset.
- ✓ The cooling fan will continue to run until the cooking compartment has cooled down.

## 7.9 Viewing the current temperature

You can view the current temperature while the appliance is heating up.

- ▶ Press  $\text{I}$ .
- ✓ The temperature will be displayed for a few seconds.

## 7.10 Displaying information

**Requirement:** The  $\text{I}$  button must be lit.

- ▶ Press  $\text{I}$ .
- ✓ The information will be displayed for a few seconds.

# 8 Steam

Food can be cooked particularly gently using steam. You can use the special types of steam heating, or use steam assistance with certain types of heating.

### **⚠ WARNING – Risk of scalding!**

Hot steam may escape when you open the appliance door. Steam may not be visible, depending on the temperature.

- ▶ Open the appliance door carefully.
- ▶ Keep children at a safe distance.

## 8.1 Filling the water tank

### **⚠ WARNING – Risk of fire!**

Due to the hot surfaces, vapours from flammable liquids may catch fire in the cooking compartment (explosion). The appliance door may spring open. Hot steam and jets of flame may escape.

- ▶ Do not pour flammable liquids (e.g. alcoholic drinks) into the water tank.
- ▶ Only fill the water tank with water or with the descaling solution we have recommended.

### **⚠ WARNING – Risk of burns!**

The water tank may heat up while the appliance is in operation.

- ▶ Wait until the water tank has cooled down from the previous operation.
- ▶ Remove the water tank from the tank recess.

**Requirement:** The water hardness must be set correctly.

→ "Before using for the first time", Page 11

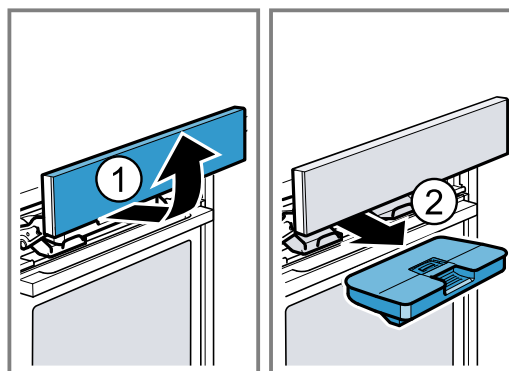

1. Press  $\text{I}$ .
- ✓ The control panel will pop out automatically.
2. Pull the control panel towards you with both hands and then push it upwards until it clicks into place  $\text{①}$ .
3. Lift the water tank and remove it from the water tank recess  $\text{②}$ .

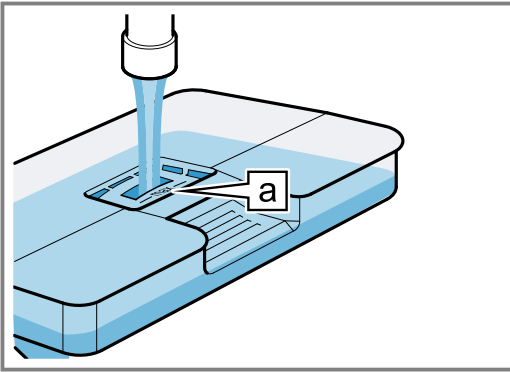

4. Press down on the water tank lid along the seal to prevent water from leaking out of the water tank.

5. Fill the water tank with water up to the "max"  mark.



6. Slide the full water tank back into the recess . When doing so, make sure that the water tank clicks into place in the retainers .

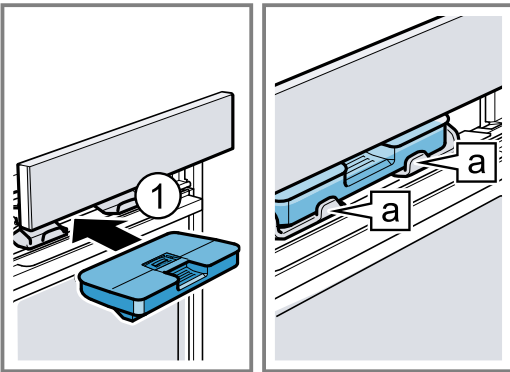

7. Slowly slide the control panel downwards and then push it away from you until it is closed completely.

## 8.2 Refilling the water tank

When "Fill water tank" appears on the display, you must refill the water tank.

### Notes

- Steam, Dough proving, Defrost and Reheat functions: If you do not refill the water tank, the appliance will stop. Refill the water tank.
- Steam-assisted heating: If you do not refill the water tank, the appliance will continue to heat but without injecting steam into the cooking compartment.

1. Open the control panel.
2. Remove and refill the water tank.
3. Insert the full water tank and close the control panel.

## 8.3 Steam heating functions

Your appliance has several steam heating functions:













- Steam 
- Dough proving 
- Defrost 
- Reheat 

### Steam

With the "Steam" heating function, the food is enveloped by hot steam, which helps to retain the nutrients. This cooking method also helps to retain the shape, colour and typical flavour of the food.

#### Configuring the Steam heating function

1. Fill the water tank.  
→ "Filling the water tank", Page 13











2. Press  to switch the appliance on.
3. Press .
4. Use the  or  button to set "Steam" .
5. Use the  button to navigate to the next row.
6. Use the  or  button to select the required temperature.
7. Use the  button to navigate to the next row.
8. Use the  or  button to select the required cooking time.
9. Press  to start the steaming process.  
→ "Pausing operation", Page 13  
→ "Cancelling operation", Page 13
- ✓ If the water tank runs dry during the steaming process, steaming will be paused.  
→ "Refilling the water tank", Page 14
- ✓ Once the cooking time has elapsed, an audible signal will sound and the appliance will stop heating.  
→ "Switching off the appliance", Page 12
10. Press any button to end the audible signal.
11. Empty the water tank and dry the cooking compartment.

### Dough proving

Yeast dough will prove considerably more quickly using the "Dough proving" heating function than at room temperature, and it will not dry out.

#### Configuring the Dough proving heating function









**Requirement:** The cooking compartment must have cooled down completely.

1. Fill the water tank.  
→ "Filling the water tank", Page 13
2. Press  to switch the appliance on.
3. Use the  or  button to set "Dough proving" .
4. Use the  button to navigate to the next row.
5. If necessary, use the  button to set setting 2.
6. Use the  button to navigate to the next row.
7. Use the  or  button to select the required proving time.
8. Press  to start the dough proving process.  
→ "Pausing operation", Page 13  
→ "Cancelling operation", Page 13
- ✓ If the water tank runs dry during the dough proving process, dough proving will be paused.  
→ "Refilling the water tank", Page 14
- ✓ Once the duration has elapsed, an audible signal will sound and the appliance will stop heating.  
→ "Switching off the appliance", Page 12
9. Press any button to end the audible signal.
10. Empty the water tank and dry the cooking compartment.

### Defrost

Use the "Defrost" function to defrost deep-frozen and frozen products.

#### Configuring the Defrost heating function

1. Fill the water tank.  
→ "Filling the water tank", Page 13
2. Press  to switch the appliance on.
3. Use the  or  button to set "Defrost" .
4. Use the  button to navigate to the next row.
5. Use the  or  button to select the required temperature.
6. Use the  button to navigate to the next row.

7. Use the < or > button to select the required defrosting time.
8. Press ▷|| to start the defrosting process.  
→ "Pausing operation", Page 13  
→ "Cancelling operation", Page 13
- ✓ If the water tank runs dry during the defrosting process, defrosting will be paused.  
→ "Refilling the water tank", Page 14
- ✓ Once the duration has elapsed, an audible signal will sound and the appliance will stop heating.  
→ "Switching off the appliance", Page 12
9. Press any button to end the audible signal.
10. Empty the water tank and dry the cooking compartment.

## Reheat

The "Reheat" function is used to warm up food that has already been cooked, or bread and pastries from the day before, without affecting its quality.

### Configuring the Reheat heating function





1. Fill the water tank.  
→ "Filling the water tank", Page 13
2. Press ⏻ to switch the appliance on.
3. Use the < or > button to set "Reheat" .
4. Use the ~ button to navigate to the next row.
5. Use the < or > button to select the required temperature.
6. Use the ~ button to navigate to the next row.
7. Use the < or > button to select the required reheating time.
8. Press ▷|| to start the reheating process.  
→ "Pausing operation", Page 13  
→ "Cancelling operation", Page 13
- ✓ If the water tank runs dry during the reheating process, reheating will be paused.  
→ "Refilling the water tank", Page 14
- ✓ Once the duration has elapsed, an audible signal will sound and the appliance will stop heating.  
→ "Switching off the appliance", Page 12
9. Press any button to end the audible signal.
10. Empty the water tank and dry the cooking compartment.

## 8.4 Steam-assisted cooking

When you cook with steam assistance, the appliance introduces steam into the cooking compartment at various intervals. This gives your food a crispy crust and a shiny surface. Meat stays juicy, tender and only undergoes a minimum reduction in volume.



### Heating functions compatible with steam assistance

You can switch on steam assistance for the following heating functions:

- "CircoTherm hot air" 
- "Top/bottom heating" 
- "Circo-roasting" 
- "Bread-baking setting" 
- "Keep warm" 

### Switching on steam assistance

1. Fill the water tank.  
→ "Filling the water tank", Page 13
2. Press ⏻ to switch the appliance on.

3. Set a suitable heating function.  
→ "Heating functions compatible with steam assistance", Page 15
4. Set the required temperature.
5. Use the  button to switch on steam assistance.
6. Use the ~ button to navigate to the row featuring the steam intensity .
7. Use the < or > button to select the required steam intensity:
  - Low
  - Medium
  - High
8. Press ▷|| to start steam-assisted heating.
  - ✓ If the water tank runs dry during steam-assisted heating, "Fill water tank" will appear on the display. The appliance will continue to heat but without injecting steam into the cooking compartment.  
→ "Refilling the water tank", Page 14

### Cancelling steam-assisted cooking

- ▶ Press .
- ✓ The appliance will continue to heat but without injecting steam into the cooking compartment.

### Ending steam-assisted heating

1. Press ⏻ to switch the appliance off.
2. Empty the water tank and dry the cooking compartment.

## 8.5 After every steam operation

The remaining water is pumped back into the water tank after every operation with steam. Then empty and dry the water tank and the cooking compartment.

### Emptying the water tank

#### WARNING – Risk of burns!

The water tank may heat up while the appliance is in operation.

- ▶ Wait until the water tank has cooled down from the previous operation.
- ▶ Remove the water tank from the tank recess.

#### ATTENTION!

Drying the water tank in the hot cooking compartment leads to damage to the water tank.

- ▶ Do not dry the water tank in the hot cooking compartment.

Cleaning the water tank in the dishwasher will damage it.

- ▶ Do not clean the water tank in the dishwasher.
- ▶ Clean the water tank with a soft cloth and standard washing-up liquid.

**Note:** Once the appliance has been switched off, the  button remains lit for a little longer to remind you to empty the water tank.

1. Use  to open the control panel.
2. Remove the water tank.
3. Carefully remove the lid of the water tank.
4. Empty the water tank, clean it with detergent and then rinse it thoroughly with clean water.
5. Dry all parts with a soft cloth.
6. Rub the seal on the lid until dry.
7. Leave the water tank to dry with the lid open.
8. Place the lid on the water tank and push down on it.

9. Insert the water tank and close the control panel.

### Drying the condensation tray

#### **⚠ WARNING – Risk of burns!**

The appliance becomes hot during operation.

- ▶ Allow the appliance to cool down before cleaning.

**Requirement:** The cooking compartment has cooled down.

1. Open the appliance door.

2. **Note:**

The condensation tray [a] is underneath the cooking compartment.

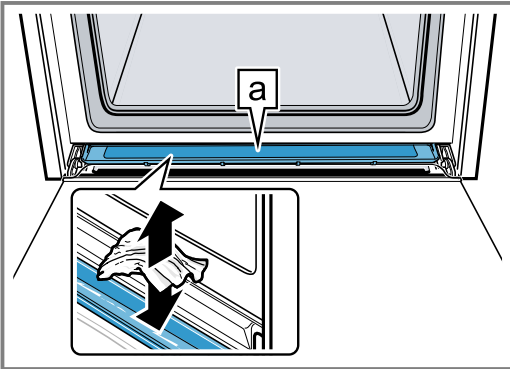

Soak up the water in the condensation tray [a] with a tea towel and wipe it carefully.

**Note:** You can remove the condensation tray in order to clean it.

### Drying the cooking compartment

To dry the cooking compartment, you can either use the "Dry" function or you can dry the cooking compartment manually.

#### Drying the cooking compartment with the Dry function

The "Dry" function heats up the cooking compartment so that the moisture in the cooking compartment evaporates. You will then need to open the appliance door to allow the steam to escape.

#### **⚠ WARNING – Risk of burns!**

The appliance becomes hot during operation.

- ▶ Allow the appliance to cool down before cleaning.

#### **ATTENTION!**

If there is water on the cooking compartment floor when operating the appliance at temperatures above 120 °C, this will damage the enamel.

- ▶ Do not use the appliance if there is water on the cooking compartment floor.
- ▶ Wipe away any water on the cooking compartment floor before operation.

**Requirement:** The cooking compartment must have cooled down.

1. Remove any food remnants from the cooking compartment.
2. Dry the cooking compartment with a sponge.
3. Press **⏻** to switch the appliance on.
4. Press **⏻**.
5. Use the **<** or **>** button to set "Dry" **☁**.
6. Use the **~** button to navigate to the next row.
  - ✓ The duration will appear on the display. The duration cannot be changed.
7. Use the **~** button to navigate to the next row.
8. Press **▶||** to start drying the appliance.
  - ✓ Once the duration has elapsed, an audible signal will sound and the appliance will stop heating.
9. Press **⏻** to switch the appliance off.
10. Remove limescale marks with a cloth soaked in vinegar, then wipe with clean water and dry with a soft cloth.
11. Leave the appliance door open for 1-2 minutes so that the cooking compartment dries completely.

### Drying the cooking compartment manually

#### **⚠ WARNING – Risk of burns!**

The appliance becomes hot during operation.

- ▶ Allow the appliance to cool down before cleaning.

#### **ATTENTION!**

If there is water on the cooking compartment floor when operating the appliance at temperatures above 120 °C, this will damage the enamel.

- ▶ Do not use the appliance if there is water on the cooking compartment floor.
- ▶ Wipe away any water on the cooking compartment floor before operation.

**Requirement:** The cooking compartment must have cooled down.

1. Remove any food remnants from the cooking compartment.
2. Dry the cooking compartment with a sponge.
3. Leave the cooking compartment to dry with the appliance door open for 1 hour.
4. Remove limescale marks with a cloth soaked in vinegar, then wipe with clean water and dry with a soft cloth.
5. Leave the appliance door open for 1-2 minutes so that the cooking compartment dries completely.





## 9 Time-setting options

Your appliance has different time-setting options, with which you can control its operation.

### 9.1 Overview of the time-setting options







When you are setting a time, the time values will increase by greater increments as you scroll through the higher values. The cooking time, for example, can be set in 1-minute increments up to 1 hour, and then in 5-minute increments thereafter.

Time-setting option	Use
Timer 	When you set a time on the timer, the timer will run independently of the appliance and will not intervene in its operation. The timer does not affect the appliance.
Cooking time 	Once the cooking time has elapsed, the appliance automatically stops heating.
Ready at 	Along with the cooking time (duration), you can set the time at which you want cooking to end. The appliance will start up automatically so that it finishes cooking at the required time.



### 9.2 Timer

You can set the timer regardless of whether the appliance is on or off.



#### Setting the timer

1. Press .
2. Once the appliance is switched on, use the  button to select "Timer" .
3. Use the  or  button to select the timer duration.
4. Press  to start the timer.
- ✓  will appear on the display. The timer duration will then count down.
- ✓ Once the timer duration has elapsed, an audible signal will sound.
5. Press any button to end the audible signal.

#### Changing the timer

1. Press .
2. Use the  or  button to change the timer duration.
- ✓ The setting will then be applied.

#### Cancelling the timer

1. Press .
2. Use the  button to set a timer duration of "00:00".
- ✓ This cancels the current timer duration.



### 9.3 Cooking time



Once the set cooking time has elapsed, the appliance switches off automatically. You can only use the cooking time in conjunction with a heating function.

#### Setting the cooking time



1. Set a heating function and a temperature.

2. Press .
3. Select the default value.



Button	Default value
	10 minutes
	30 minutes

4. Use the  or  button to select the required cooking time.
5. Once the cooking time has been set, press  to start.
  - ✓ The cooking time will appear on the display. The cooking time will count down.
  - ✓ Once the cooking time has elapsed, an audible signal will sound.
6. Press any button to end the audible signal.

#### Changing the cooking time

1. Press .
2. Use the  or  button to change the cooking time.
- ✓ The setting will then be applied.

#### Cancelling the cooking time







1. Press .
2. Use the  button to set a cooking time of "00:00".
- ✓ This cancels the current cooking time.
3. To continue without setting a cooking time, press .

### 9.4 Delayed start/"Ready at" time



With this function, the appliance automatically switches itself on, and then switches itself off at the preselected end time. To enable it to do this, you set the cooking time (duration) and specify when you want your food to be ready. You can only use the delayed start function in conjunction with a heating function.

#### Setting the Ready at time for delayed starts

##### Notes

- Do not leave food that spoils easily in the cooking compartment for too long.
  - You cannot use the delayed start function with every heating function.
1. Place the food into the cooking compartment and close the appliance door.
  2. Set a heating function and a temperature.
  3. Press .
  4. Use the  or  button to select the required cooking time.
  5. Use the  button to navigate to "Ready at" .
  - ✓ The time at which your food will be ready will appear on the display.
  6. Use the  button to select the required end time.
  7. Press  to confirm the delayed start.
  - ✓ The appliance will start at the appropriate time.
  - ✓ Once the cooking time has elapsed, an audible signal will sound.
  8. Press any button to end the audible signal.

#### Changing the Ready at time for delayed starts

1. Press .
2. Use the  button to select "Ready at" .

3. Use the < or > button to change the end time.  
✓ The setting will then be applied.

### Cancelling the Ready at time for delayed starts

1. Press ☺.

2. Use the < button to reset the end time.  
✓ The end time corresponds to the current time plus the set cooking time.  
✓ The appliance will start heating using the set cooking time.

---

## 10 Baking and roasting assistant

The baking and roasting assistant helps you to use your appliance to cook various dishes by suggesting the optimal settings.

The baking and roasting assistant helps you to make classic cakes, bread and roasts. The appliance selects the optimal heating function for you. The default temperature and cooking time can be changed according to your requirements.

### 10.1 Overview of available foods

You can choose from the following foods:

- Rich fruit cake
- Victoria sponge cake
- Victoria sponge cake, on two levels
- Swiss roll
- Jam tarts
- Jam tarts, on two levels
- Fruit crumble
- Pavlova
- Vol au vents
- Small cakes
- Small cakes, on two levels
- White bread
- Scones
- Scones, on two levels
- Pizza, frozen
- Oven chips
- Baked potatoes
- Baked potatoes, on two levels
- Lasagne, chilled
- Roast pork
- Top rump
- Slow roasting joint
- Leg of lamb
- Whole chicken
- Chicken drumsticks
- Duck

### 10.2 Configuring the baking and roasting assistant

**Note:** Use fresh and, ideally, chilled food. Use frozen food straight from the freezer.

**Requirement:** The cooking compartment must have cooled down.

1. Press ☺ to switch the appliance on.
2. Press ☒.
3. Use the < or > button to select the "Baking and roasting assistant" ☒.
4. Use the ~ button to navigate to the next row.
5. Use the < or > button to select the required category.
6. Use the ~ button to navigate to the next row.
7. Use the < or > button to select the required food.
8. Use the ~ button to navigate to the next row.  
✓ The recommended settings will appear on the display.
9. **Note:** Additional information cannot be selected for all foods.  
Use the > button to view additional information.  
✓ Additional information will appear, for example regarding which shelf position, accessories or cookware you should use or when you should turn or stir your food or add liquid.
10. Use the < button to navigate back to the recommended settings.
11. Use the ~ button to adjust the temperature or cooking time, if required.
  - Use the ~ or ^ button to select the temperature or cooking time.
  - Use the < or > button to change the setting.
12. Press ▶|| to start the baking and roasting assistant.  
✓ Some food needs to be turned or stirred. An audible signal will sound and a notification will appear on the display to let you know when it is time to turn or stir your food.  
✓ Once the duration has elapsed, an audible signal will sound and the appliance will stop heating.
13. **Note:** Some programs allow you to extend the cooking time.  
→ "Extending the cooking time", Page 18  
If you are happy with the cooking result, use the ^ button to select "End".

### 10.3 Extending the cooking time

1. Use the ~ button to select "Extend cooking time".
2. Use the < or > button to change the settings, if required.
3. Press ▶|| to start the appliance again for the extra cooking time.

# 11 Steam programs

The steam programs help you to use your appliance to cook various dishes by selecting the optimal settings automatically.

## 11.1 Cookware

The cooking result depends on the composition of the meat and the size of cookware.

You should therefore use heat-resistant cookware that is suitable for temperatures up to 300 °C. Glass or glass ceramic cookware is best. The joint should cover approx. two thirds of the cookware base.

Cookware made from the following material is not suitable:

- Bright, shiny aluminium
- Unglazed clay
- Plastic or plastic handles

## 11.2 Overview of the steam programs

You can choose from the following steam programs:

- White bread, without a tin
- Wheat bread, wheat bread with rye, in a loaf tin
- Flatbread
- Plaited loaf, unfilled/plaited ring
- Sponge cake
- Boned pork neck joint
- Top side, top rump
- Leg of lamb
- Chicken, whole, fresh
- Chicken pieces, fresh
- Duck, goose, unstuffed, fresh
- Fish fillet
- Whole fish
- Cauliflower florets, steam
- Broccoli florets, steaming
- Fish, whole, steam
- Green beans, steaming
- Sliced carrots, steaming
- Vegetables, frozen
- Basmati rice
- Brown rice
- Couscous
- Cooked side dishes, reheat
- Chicken breast
- Fish fillet, fresh
- Rice pudding
- Fruit compote
- Eggs, soft-boiled
- Eggs, hard-boiled
- Bottles, sterilise

## 11.3 Preparing food for the steam program

**Note:** Use fresh and, ideally, chilled food. Use frozen food straight from the freezer.















- ▶ Weigh the food.  
Some steam programs need to know the weight of the food in order to configure the steam program's settings accordingly.

## 11.4 Configuring the steam program





### **WARNING – Risk of scalding!**

Hot steam may escape when you open the appliance door. Steam may not be visible, depending on the temperature.

- ▶ Open the appliance door carefully.
- ▶ Keep children at a safe distance.

1. Fill the water tank and insert it.
2. Press  to switch the appliance on.
3. Press .
4. Use the  or  button to select "Steam programs" .
5. Use the  button to navigate to the next row.
6. Use the  or  button to select the required steam program.
7. Use the  button to navigate to the next row.
8. Use the  or  button to select the appropriate weight.
9. Use the  button to navigate to the next row.
- ✓ The recommended shelf position and cookware will be displayed.
10. Press  to start the steam program.
- ✓ The calculated cooking time will be displayed. For some steam programs, the cooking time may change during the first few minutes, as the heating-up time depends on the temperature of the food and the water, amongst other things.
- ✓ Once the cooking time has elapsed, an audible signal will sound and the appliance will stop heating.
11. **Note:** Some steam programs allow you to extend the cooking time.  
→ "Extending the cooking time", Page 19  
If you are happy with the cooking result, use the  button to select "End".

## 11.5 Extending the cooking time



1. Use the  button to select "Extend cooking time".
2. Use the  or  button to change the settings, if required.
3. Press  to start the appliance again for the extra cooking time.

## 12 Childproof lock

You can secure your appliance to prevent children from accidentally switching it on or changing the settings.



### 12.1 Locks

Your appliance has two different locks:













Lock	Activate/deactivate
Automatic childproof lock	Via the MyProfile menu 
One-time childproof lock	Using the  button

### 12.2 Activating the automatic childproof lock

The automatic childproof lock disables the control panel to prevent children from accidentally switching on the appliance. To switch on the appliance, interrupt the automatic childproof lock. Once the appliance has finished cooking, it automatically disables the control panel.

**Note:** When you activate the automatic childproof lock, the appliance will immediately disable the control panel. The  and  buttons will not be disabled.

**Requirement:** The appliance must be switched on.













1. Press .
  2. Use the  or  button to select "MyProfile" .
  3. Use the  button to navigate to the next row.
  4. Use the  or  button to select "Automatic childproof lock".
  5. Use the  button to select the required settings.
  6. Use the  button to set the lock to "Activated".
  7. Press .
  8. Use the  button to save your settings.
- ✓ When you switch off the appliance,  will appear on the display.

### 12.3 Interrupting the automatic childproof lock

1. Press and hold the  button until "Childproof lock deactivated" appears on the display.



2. Press  to switch the appliance on and then start it up.

### 12.4 Deactivating the automatic childproof lock

1. Press and hold the  button until "Childproof lock deactivated" appears on the display.
2. Press  to switch the appliance on.
3. Press .
4. Use the  or  button to select "MyProfile" .
5. Use the  button to navigate to the next row.
6. Use the  or  button to select "Automatic childproof lock".
7. Use the  button to select the required settings.
8. Use the  button to set the lock to "Deactivated".
9. Press .
10. Use the  button to save your settings.

### 12.5 Activating the one-time childproof lock

The one-time childproof lock disables the control panel to prevent children from accidentally switching on the appliance. To switch on the appliance, deactivate the one-time childproof lock. After you have switched off the appliance, the control panel will no longer be disabled.

**Note:** When you activate the automatic childproof lock, the appliance will immediately disable the control panel. The  and  buttons will not be disabled.

- ▶ Press and hold the  button until "Childproof lock activated" appears on the display.



### 12.6 Deactivating the one-time childproof lock

- ▶ Press and hold the  button until "Childproof lock deactivated" appears on the display.

## 13 Rapid heat-up

You can use the "Rapid heat-up" and "PowerBoost" functions to reduce the heat-up time. Whether the appliance is preheated with the "Rapid heat-up" function or the "PowerBoost" function depends on the heating function that has been set.

### 13.1 Rapid heat-up and PowerBoost

Function	Heating function	Food in the cooking compartment
Rapid heat-up	Top/bottom heating 	After preheating
PowerBoost	<ul style="list-style-type: none"> <li>■ CircoTherm hot air </li> <li>■ Bread-baking setting </li> </ul>	Before heating up Only cook on one level



## 13.2 Activating the "Rapid heat-up" function

1. Set Top/bottom heating  $\equiv$  and a temperature of at least 100 °C.
2. Press  $\triangleright$  to start.
  - ✓ The  $\text{⏏}$  button will be lit.
3. Use the  $\text{⏏}$  button to activate the "Rapid heat-up" function.
  - ✓  $\text{⏏}$  will appear on the display.
  - ✓ Once the set temperature has been reached, the "Rapid heat-up" function will switch itself off automatically and an audible signal will sound.  $\text{⏏}$  will go out on the display.
4. Place the food in the cooking compartment.

## 13.3 Deactivating the "Rapid heat-up" function

- ▶ Use the  $\text{⏏}$  button to deactivate the "Rapid heat-up" function early.

## 13.4 Activating the "PowerBoost" function

1. Place the food on a single level in the cooking compartment.
2. Set CircoTherm hot air  $\text{⏏}$  or the Bread-baking setting  $\text{⏏}$  and a temperature of at least 100 °C.
3. Press  $\triangleright$  to start.
  - ✓ The  $\text{⏏}$  button will be lit.
4. Press the  $\text{⏏}$  button to activate the "PowerBoost" function.
  - ✓  $\text{⏏}$  will appear on the display.
  - ✓ Once the set temperature has been reached, the "PowerBoost" function will switch itself off automatically and an audible signal will sound.  $\text{⏏}$  will go out on the display.

## 13.5 Deactivating the "PowerBoost" function

- ▶ Use the  $\text{⏏}$  button to deactivate the "PowerBoost" function early.

# 14 Sabbath mode

You can set a cooking time of up to 74 hours using Sabbath mode. You can use top/bottom heating to keep food warm between 85 °C and 140 °C during this time without having to switch the appliance on or off.

## 14.1 Starting Sabbath mode

### Notes

- If you open the appliance door during operation, the appliance stops heating. When you close the appliance door, the appliance continues to heat again.
- Once you have started the operation, you cannot change any settings or pause operation.

**Requirement:** Sabbath mode must be activated in "Favourites" in the basic settings.

→ "Basic settings", Page 21

1. Press  $\text{⏏}$  to switch the appliance on.
2. Use  $\langle$  or  $\rangle$  to select "Sabbath mode".

3. Use  $\vee$  to navigate to the next row.
4. Use  $\langle$  or  $\rangle$  to select the temperature.
5. Use  $\vee$  to navigate to the next row.
6. Use  $\langle$  or  $\rangle$  to select the cooking time.
7. Press  $\triangleright$  to start Sabbath mode.
  - ✓ The cooking time appears on the display. The cooking time counts down.
8. Once the cooking time has elapsed, an audible signal sounds. A note appears on the display confirming that the operation has finished. The appliance stops heating up and responds again as usual outside of Sabbath mode.
  - Press  $\text{⏏}$  to switch the appliance off. The appliance automatically switches off after approx. 10 to 20 minutes.

## 14.2 Cancelling Sabbath mode

- ▶ Press  $\text{⏏}$  to cancel Sabbath mode.

# 15 Basic settings

You can configure the appliance to meet your needs.

## 15.1 Overview of the basic settings

Here you can find an overview of the basic settings and factory settings. The basic settings depend on the features of your appliance.

Basic setting	Selection
Language	See selection on the appliance
Time	00:00 - 23:59
Date	Day, month and year

<sup>1</sup> Depending on the appliance specifications

Basic setting	Selection
Water hardness → "Before using for the first time", Page 11	<ul style="list-style-type: none"> <li>■ 0 (softened)</li> <li>■ 1 (soft)</li> <li>■ 2 (moderately hard)</li> <li>■ 3 (hard)</li> <li>■ 4 (very hard)</li> </ul>
Favourites → "Changing your favourites", Page 22	Set the heating functions that you want to appear in the heating functions menu
Audible signal	<ul style="list-style-type: none"> <li>■ Short duration</li> <li>■ Medium duration</li> <li>■ Long duration</li> </ul>

<sup>1</sup> Depending on the appliance specifications

Basic setting	Selection
Button tone	<ul style="list-style-type: none"> <li>■ Off (except for Ⓞ)</li> <li>■ On</li> </ul>
Display brightness	5 settings
Clock display	<ul style="list-style-type: none"> <li>■ Digital</li> <li>■ Off</li> </ul>
Lighting	<ul style="list-style-type: none"> <li>■ On during operation</li> <li>■ Off during operation</li> </ul>
Automatic childproof lock	<ul style="list-style-type: none"> <li>■ Deactivated</li> <li>■ Activated</li> </ul>
Operation after switch-on	<ul style="list-style-type: none"> <li>■ Main menu</li> <li>■ Types of heating</li> <li>■ Steam</li> <li>■ Baking and roasting assistant</li> <li>■ Steam programs</li> </ul>
Night-time dimming	<ul style="list-style-type: none"> <li>■ Switched off</li> <li>■ On (display dimmed between 10 p.m. and 5.59 a.m.)</li> </ul>
Brand logo	<ul style="list-style-type: none"> <li>■ Indicators/symbols</li> <li>■ Do not display</li> </ul>
Fan run-on time	<ul style="list-style-type: none"> <li>■ Recommended</li> <li>■ Minimum</li> </ul>
Pull-out rail system <sup>1</sup>	<ul style="list-style-type: none"> <li>■ Not retrofitted (rack)</li> <li>■ Retrofitted (single set of pull-out rails)</li> </ul>
Home Connect	Home Connect Settings → "Home Connect ", Page 22
Factory settings	Restore

<sup>1</sup> Depending on the appliance specifications

## 15.2 Changing MyProfile

1. Press Ⓞ to switch the appliance on.
2. Press ⏠.

3. Use the < or > button to select "MyProfile" Ⓒ.
4. Use the ~ button to navigate to the next row.
5. Use the < or > button to select a setting.
6. Use the ~ button to navigate to the next row.
7. Use the < or > button to change the setting.
8. Press ⏠.
9. To save your settings, use the ~ button to select "Save".
  - To discard your settings, use the ^ button to select "Discard".

## 15.3 Changing your favourites

In Favourites, you can set the heating functions that you want to appear in the heating functions menu.

### Note:

Some heating functions cannot be deactivated:

- CircoTherm hot air Ⓐ
- Circo-roasting Ⓐ
- Full-surface grill Ⓐ

1. Press Ⓞ to switch the appliance on.
2. Press ⏠.
3. Use the < or > button to select "MyProfile" Ⓒ.
4. Use the ~ button to navigate to the next row.
5. Use the < or > button to select "Favourites".
6. Use the ~ button to select "Set favourites".
7. Use the < or > button to select the required heating function.
8. Use the ~ button to navigate to the next row.
9. Use the < or > button to select a setting.

Setting	Display in the heating functions menu?
Activated	Yes
Deactivated	No

10. Press ⏠.
11. To save your settings, use the ~ button to select "Save".
  - To discard your settings, use the ^ button to select "Discard".

# 16 Home Connect

This appliance is network-capable. Connecting your appliance to a mobile device lets you control its functions via the Home Connect app, adjust its basic settings and monitor its operating status.

The Home Connect services are not available in every country. The availability of the Home Connect function depends on the availability of Home Connect services in your country. You can find information about this at: [www.home-connect.com](http://www.home-connect.com).

The Home Connect app guides you through the entire login process. Follow the instructions in the Home Connect app to configure the settings.

### Tips

- Please consult the documents supplied by Home Connect.
- Please also follow the instructions in the Home Connect app.

### Notes

- Please note the safety precautions in this instruction manual and make sure that they are also observed when operating the appliance via the Home Connect app.
  - "Safety", Page 2
- Operating the appliance on the appliance itself always takes priority. During this time it is not possible to operate the appliance using the Home Connect app.
- In networked standby mode, the appliance requires a maximum of 2 W.

## 16.1 Setting up Home Connect

### Requirements

- The appliance is connected to the power supply and is switched on.
- You have a mobile device with a current version of the iOS or Android operating system, e.g. a smartphone.
- The mobile device and the appliance are within range of your home network's Wi-Fi signal.

1. Download the Home Connect app.



2. Open the Home Connect app and scan the following QR code.



3. Follow the instructions in the Home Connect app.

## 16.2 Home Connect Settings

You can adjust the settings and network settings for Home Connect by going to your appliance's basic settings. Which settings the display shows will depend on whether Home Connect has been set up and whether the appliance is connected to your home network.

Basic setting	Possible settings	Explanation
Wi-Fi	Switch on Switch off	If Wi-Fi is activated, you can use Home Connect. In networked standby mode, the appliance requires a maximum of 2 W.
Network	Connect to network Disconnect from network	If you disconnect the appliance from the network, all network information will be deleted. This setting is useful if you have new login details for the router.
Connect to app	-	This setting initiates the connection between the Home Connect app and the appliance.
Remote control	On Off	When this function is deactivated, all you can do is view the appliance's operating status in the app. When this function is activated, you can remotely start and control the appliance.
Appliance information 	-	The display shows information about the network or the appliance.





## 16.3 Operating the appliance with the Home Connect app



When the Remote start function is activated, you can use the Home Connect app to remotely configure the appliance's settings and start it.

**Note:** Some operating modes can only be started on the oven itself.

### Requirements

- The appliance must be switched on.
- The appliance must be connected to your home network and to the Home Connect app.
- To configure the appliance's settings using the Home Connect app, "Remote control" must be switched on in the basic settings. When the Remote start function is deactivated, only the appliance's operating statuses are displayed in the Home Connect app.

1. Press  to switch the appliance on.
2. Tap .
- ✓ The display will show the main menu.
3. Use the  or  button to select "Remote start" .

4. To switch on the Remote start function, tap .
- ✓ The display will show .
5. Configure a setting in the Home Connect app and send it to the appliance.

### Notes

- If you open the appliance door within 15 minutes of activating the Remote start function or of the set program ending, the Remote start function will be deactivated.
- When you start the oven using the controls on the appliance itself, the Remote start function is activated automatically. You can use the Home Connect app to adjust the settings or start a new program.

## 16.4 Software update

Your appliance's software can be updated using the software update function, e.g. for the purposes of optimisation, troubleshooting or security updates. To do this, you must be a registered Home Connect user, have installed the app on your mobile device and be connected to the Home Connect server. As soon as a software update is available, you will be informed via the Home Connect app and will be able to start the software update via the app. Once the update has been successfully downloaded, you can start installing it via the Home Connect app if you are in your WLAN home network (Wi-Fi). The Home Connect app will inform you once installation is successful.

### Notes

- You can continue to use your appliance as normal while updates are downloading. Depending on your personal settings in the app, software updates can also be set to download automatically.
- We recommend that you install security updates as soon as possible.

## 16.5 Remote diagnostics

Customer Service can use Remote Diagnostics to access your appliance if you contact them, have your appliance connected to the Home Connect server and if Remote Diagnostics is available in the country in which you are using the appliance.

**Tip:** For further information and details about the availability of Remote Diagnostics in your country, please visit the service/support section of your local website: [www.home-connect.com](http://www.home-connect.com)

## 16.6 Data protection

Please see the information on data protection. The first time your appliance is registered on a home network connected to the Internet, your appliance will transmit the following types of data to the Home Connect server (initial registration):

- Unique appliance identification (consisting of appliance codes as well as the MAC address of the Wi-Fi communication module installed).
- Security certificate of the Wi-Fi communication module (to ensure a secure data connection).
- The current software and hardware version of your appliance.
- Status of any previous reset to factory settings.

This initial registration prepares the Home Connect functions for use and is only required when you want to use the Home Connect functions for the first time.

**Note:** Please note that the Home Connect functions can only be utilised with the Home Connect app. Information on data protection can be retrieved in the Home Connect app.

---

# 17 Cleaning and servicing

To keep your appliance working efficiently for a long time, it is important to clean and maintain it carefully.

## 17.1 Cleaning products

In order to avoid damaging the various oven surfaces on the appliance, do not use unsuitable cleaning products.

### **WARNING – Risk of electric shock!**

An ingress of moisture can cause an electric shock.

- ▶ Do not use steam- or high-pressure cleaners to clean the appliance.

### **ATTENTION!**

Unsuitable cleaning products may damage the surfaces of the appliance.

- ▶ Do not use harsh or abrasive cleaning products.
- ▶ Do not use cleaning products with a high alcohol content.
- ▶ Do not use hard scouring pads or cleaning sponges.
- ▶ Do not use any special cleaners for cleaning the appliance while it is hot.

Using oven cleaner in a hot cooking compartment damages the enamel.

- ▶ Never use oven cleaner in the cooking compartment when it is still warm.
- ▶ Remove all food remnants from the cooking compartment and the appliance door before you next heat up the appliance.

New sponge cloths contain residues from production.

- ▶ Wash new sponge cloths thoroughly before use.

### **Suitable cleaning agents**

Only use cleaning agents that are suitable for the different surfaces on your appliance.

Follow the instructions on cleaning the appliance.

→ "Cleaning the appliance", Page 26



## Appliance front

Surface	Suitable cleaning agents	Information
Stainless steel	<ul style="list-style-type: none"> <li>▪ Hot soapy water</li> <li>▪ Special stainless steel cleaning products suitable for hot surfaces</li> </ul>	To prevent corrosion, remove any limescale, grease, starch or albumin (e.g. egg white) stains on stainless steel fronts immediately. Apply a thin layer of the stainless steel cleaning product with a soft cloth.
Plastic or painted surfaces E.g. control panel	<ul style="list-style-type: none"> <li>▪ Hot soapy water</li> </ul>	Do not use glass cleaner or a glass scraper. To avoid permanent stains, remove any descaling agent that gets onto the surface immediately.

## Appliance door

Area	Suitable cleaning agents	Information
Door panels	<ul style="list-style-type: none"> <li>▪ Hot soapy water</li> </ul>	Do not use a glass scraper or a stainless steel wool. <b>Tip:</b> Remove the door panels in order to clean them thoroughly. → "Appliance door", Page 29
Door cover	<ul style="list-style-type: none"> <li>▪ Made of stainless steel: Stainless steel cleaner</li> <li>▪ Made of plastic: Hot soapy water</li> </ul>	Do not use glass cleaner or a glass scraper. Do not use stainless steel care products. <b>Tip:</b> Remove the door cover for thorough cleaning. → "Appliance door", Page 29
Stainless steel interior door frame	Stainless steel cleaner	Discolouration can be removed using stainless steel cleaner. Do not use stainless steel care products.
Door handle	<ul style="list-style-type: none"> <li>▪ Hot soapy water</li> </ul>	To avoid permanent stains, remove any descaling agent that gets onto the surface immediately.
Door seal	<ul style="list-style-type: none"> <li>▪ Hot soapy water</li> </ul>	Do not remove or scrub.

## Cooking compartment

Area	Suitable cleaning agents	Information
Enamel surfaces	<ul style="list-style-type: none"> <li>▪ Hot soapy water</li> <li>▪ Vinegar water</li> <li>▪ Oven cleaner</li> </ul>	Soak any heavily soiled areas and use a brush or steel wool. Leave the appliance door open to dry the cooking compartment after cleaning it. <b>Notes</b> <ul style="list-style-type: none"> <li>▪ Enamel burns at very high temperatures, causing minor discoloration. The functionality of your appliance is not affected by this.</li> <li>▪ The edges of thin trays cannot be completely enamelled and may be rough. This does not impair corrosion protection.</li> <li>▪ Food residues will leave a white coating on the enamel surfaces. The coating does not pose a health risk. The functionality of your appliance is not affected by this. You can remove residues with lemon juice.</li> </ul>
Self-cleaning surfaces	-	Follow the instructions for self-cleaning surfaces. → "Cleaning self-cleaning surfaces in the cooking compartment", Page 26
Glass cover for the oven light	<ul style="list-style-type: none"> <li>▪ Hot soapy water</li> </ul>	Use oven cleaner to remove very heavy soiling.
Rails	<ul style="list-style-type: none"> <li>▪ Hot soapy water</li> </ul>	Soak any heavily soiled areas and use a brush or steel wool. <b>Note:</b> To clean thoroughly, detach the rails. → "Rails", Page 29

Area	Suitable cleaning agents	Information
Accessories	<ul style="list-style-type: none"> <li>▪ Hot soapy water</li> <li>▪ Oven cleaner</li> </ul>	<p>Soak any heavily soiled areas and use a brush or steel wool. Enamelled accessories are dishwasher-safe. Do not use stainless steel wool on steam containers made from stainless steel.</p> <p>Use a vinegar solution to remove any dirt on stainless steel steam containers caused by starchy foods (e.g. rice).</p>
Water tank	<ul style="list-style-type: none"> <li>▪ Hot soapy water</li> </ul>	<p>To remove residual detergent after cleaning, rinse thoroughly with clean water.</p> <p>To dry the water tank after cleaning, leave the water tank to dry with the lid open. Dry the seal on the lid.</p> <p>Do not clean in the dishwasher.</p>

## 17.2 Cleaning the appliance

In order to avoid damaging the appliance, you must clean your appliance only as specified, and with suitable cleaning products.

### **WARNING – Risk of burns!**

The appliance and its parts that can be touched become hot during use.

- ▶ Caution should be exercised here in order to avoid touching heating elements.
- ▶ Young children under 8 years of age must be kept away from the appliance.

### **WARNING – Risk of fire!**

Loose food remnants, fat and meat juices may catch fire.

- ▶ Before using the appliance, remove the worst of the food residues and remnants from the cooking compartment, heating elements and accessories.

**Requirement:** Read the information on cleaning products.

→ "Cleaning products", Page 24

1. Clean the appliance using hot soapy water and a dish cloth.

- For some surfaces, you can use alternative cleaning agents.

→ "Suitable cleaning agents", Page 24

2. Dry with a soft cloth.

## 17.3 Cleaning self-cleaning surfaces in the cooking compartment

The back panel, ceiling and side walls in the cooking compartment are self-cleaning and have a coarse surface.

### **ATTENTION!**

If you do not clean the self-cleaning surfaces regularly, they may become damaged.

- ▶ If dark stains are visible on the self-cleaning surfaces, use the cleaning function to clean the cooking compartment.
- ▶ If a prompt to clean appears in the display, use the cleaning function to clean the cooking compartment.
- ▶ Do not use oven cleaner or abrasive cleaning aids. If oven cleaner accidentally comes into contact with the self-cleaning surfaces, dab it off immediately using water and a sponge cloth. Do not rub.

- ▶ Use the cleaning function.

→ "EcoClean cleaning function", Page 26

# 18 Cleaning functions

You can use the cleaning functions to clean the appliance.

## 18.1 EcoClean cleaning function

Use the "EcoClean" cleaning function regularly to help retain the cleaning ability of the self-cleaning surfaces and prevent damage.

The self-cleaning surfaces in the cooking compartment are coated with a porous, matt ceramic layer and have a rough surface. When the appliance is in operation, the self-cleaning surfaces absorb splashes from roasting or grilling and break them down.

The following surfaces are self-cleaning:

- Back wall
- Ceiling
- Side walls

### **ATTENTION!**

If you do not clean the self-cleaning surfaces regularly, they may become damaged.

- ▶ If dark stains are visible on the self-cleaning surfaces, use the cleaning function to clean the cooking compartment.
- ▶ If a prompt to clean appears in the display, use the cleaning function to clean the cooking compartment.
- ▶ Do not use oven cleaner or abrasive cleaning aids. If oven cleaner accidentally comes into contact with the self-cleaning surfaces, dab it off immediately using water and a sponge cloth. Do not rub.

### **Cleaning recommendation**

The appliance records the type and duration of the operation and, if required, recommends which cleaning function to use.

When you switch on the appliance, a notification appears in the display stating that you should use the cleaning function. Start the cleaning function as soon as possible.

You can use your appliance as normal. However, the cleaning setting appears in the display until you have run the cleaning function in full.

**Note:** If the appliance is prematurely contaminated, e.g. by greasy poultry or roasts, or if dark spots appear on the self-cleaning surfaces, do not wait until the notification appears in the display before you use the cleaning functions. The more often you use the cleaning function, the longer the cleaning ability of the self-cleaning surfaces is retained.

### Preparing the appliance for the cleaning function

In order to achieve a good cleaning result, prepare the appliance carefully.

#### ATTENTION!

Using oven cleaner on the self-cleaning surfaces damages the surfaces.

▶ Do not use oven cleaner on the self-cleaning surfaces. If oven cleaner does get onto these surfaces, dab it off immediately using water and a sponge cloth. Do not rub the surface and do not use abrasive cleaning aids.

1. Remove accessories and cookware from the cooking compartment.
2. Detach the shelf supports and remove them from the cooking compartment.  
→ "Rails", Page 29
3. Remove coarse dirt using soapy water and a soft cloth:
  - From the cooking compartment floor
  - From the inside of the appliance door
  - From the glass cover on the oven light
 This prevents stains that cannot be removed.
4. Remove any objects from the cooking compartment. The cooking compartment must be empty.









### Configuring the EcoClean cleaning function

#### ⚠ WARNING – Risk of burns!

⚠ The outside of the appliance gets very hot when the cleaning function is in progress.

- ▶ Never touch the appliance door.
- ▶ Allow the appliance to cool down.
- ▶ Keep children at a safe distance.

#### Requirements

- Prepare the appliance for the cleaning function.  
→ Page 27
  - Do not open the appliance door while the appliance is in operation, as this will abort the cleaning function.
1. Press  to switch the appliance on.
  2. Press .
  3. Use the  or  button to set "EcoClean" .
  4. Use the  button to navigate to the next row.
- ✓ The duration of the cleaning function will appear on the display.
5. Use the  button to navigate to the next row.
  6. **Note:** Keep the kitchen ventilated while the cleaning function is running.  
Press  to start the cleaning function.

- ✓ The cleaning function will start. The duration will count down on the display.
  - ✓ Once the cleaning function has run through to the end, an audible signal will sound.
7. Press any button to end the audible signal.
  8. After using the cleaning function, wipe down the cooking compartment.  
→ "Wiping the appliance clean following the cleaning function", Page 27

### Wiping the appliance clean following the cleaning function

1. Allow the appliance to cool down.
2. Wipe the cooking compartment with a damp cloth.  
**Note:** Marks may appear on the self-cleaning surfaces. Residues of sugar and egg white in the food are not removed and stick to the surfaces. Red stains are residues from salty food – they are not rust. The stains are not hazardous to health. These marks do not impair the cleaning ability of the self-cleaning surfaces.
3. Attach the shelf supports.  
→ "Rails", Page 29

## 18.2 Floor cleaning aid

You can use the "floor cleaning aid" to clean the cooking compartment floor. The "floor cleaning aid" soaks dirt by evaporating soapy water. It is then easier to remove the dirt.







### Setting the floor cleaning aid

#### ⚠ WARNING – Risk of scalding!

If there is water in the cooking compartment when it is hot, this may create hot steam.

- ▶ Never pour water into the cooking compartment when the cooking compartment is hot.

#### Requirements

- You can only start the cleaning aid once the cooking compartment is cold (room temperature) and the appliance door is closed.
  - Do not open the appliance door while the appliance is in operation, as this will abort the cleaning aid.
  - To remove particularly stubborn dirt, leave the soapy water to work for a while before starting the cleaning aid.
  - To remove particularly stubborn dirt, rub washing-up liquid onto dirty areas on the smooth surfaces before starting the cleaning aid.
1. Remove any accessories from the cooking compartment.
  2. **ATTENTION!**  
Distilled water in the cooking compartment leads to corrosion.
    - ▶ Do not use distilled water.
 Mix 0.4 litres water with a drop of washing-up liquid and pour into the centre of the cooking compartment floor.
  3. Press  to switch the appliance on.
  4. Press .
  5. Use the  or  button to select "Floor cleaning aid" .
  6. Use the  button to navigate to the next row.
  7. Press  to start the cleaning aid.

- ✓ The cleaning aid will start. The duration will count down on the display.
  - ✓ Once the cleaning aid has run through to the end, an audible signal will sound.
8. Press any button to end the audible signal.
  9. After using the cleaning aid, finish cleaning the cooking compartment.  
→ *"Wiping down the cooking compartment"*, Page 28

## Wiping down the cooking compartment

### ATTENTION!

The prolonged presence of moisture in the cooking compartment leads to corrosion.

- ▶ After using the cleaning aid, wipe the cooking compartment clean and allow it to dry fully.

**Requirement:** The cooking compartment must have cooled down.

1. Open the appliance door and remove the remaining water with an absorbent sponge cloth.
2. Clean the smooth surfaces in the cooking compartment with a dish cloth or a soft brush. Remove stubborn food remnants using a stainless steel scouring pad.
3. Remove limescale with a cloth soaked in vinegar. Then wipe with clean water and rub dry with a soft cloth (including under the door seal).
4. If there is any stubborn dirt that you are unable to remove, run the cleaning aid again once the cooking compartment has cooled down.
5. In order to dry the cooking compartment, leave the appliance door open in the detent position (approx. 30°) for approx. one hour.

## 18.3 Descaling

To ensure that your appliance continues to operate correctly, it must be descaled regularly.

How frequently you need to run the descaling programme will depend on the water hardness and how many times you have used the steam function. The appliance indicates when only another five or fewer steam-assisted operations are possible. If you do not carry out the descaling, you can no longer set any operation with steam.

Descaling comprises several steps and takes approx. 70–95 minutes:

- Descaling (approx. 55–70 minutes)
- First rinse cycle (approx. 9–12 minutes)
- Second rinse cycle (approx. 9–12 minutes)

For reasons of hygiene, the descaling programme must be run in full.

If descaling is interrupted, you can no longer set any operation. To ensure that the appliance is ready for operation again, carry out two rinse cycles.

### Preparing descaling

#### ATTENTION!

The length of time for which the descaler is left to work is based on the recommended, liquid descaler. Other descalers may damage the appliance.

- ▶ Only use the liquid descaler recommended by us for the descaling programme.

If descaling solution comes into contact with the control panel or other delicate surfaces, it will damage them.

- ▶ Remove descaling solution immediately with water.

1. Mix the descaling solution:
  - 200 ml liquid descaler
  - 400 ml water
2. Open the control panel.
3. Remove the water tank and pour the descaling solution into it.
4. Once the descaling solution has been poured into the water tank, slide the tank back in.
5. Close the control panel.









### Setting the descaling process

#### ATTENTION!

If descaling solution comes into contact with the control panel or other delicate surfaces, it will damage them.

- ▶ Remove descaling solution immediately with water.

**Requirement:** The appliance must be prepared for descaling. → Page 28

1. Press  to switch the appliance on.
2. Press .
3. Use the  or  button to set "Descaling" .
4. Use the  button to navigate to the next row.
  - ✓ The duration will appear on the display. You cannot change the duration of the descaling process.
5. Use the  button to navigate to the next row.
6. Press  to start the descaling process.
  - ✓ The descaling process will start. The duration will count down on the display.
  - ✓ Once the descaling process has run through to the end, an audible signal will sound.

### Running the first rinse cycle

1. Open the control panel and remove the water tank.
2. Thoroughly rinse the water tank and fill it with fresh water.
3. Slide in the water tank and close the control panel.
4. Press  to start the rinse cycle.
  - ✓ The rinse cycle will start. The duration will count down on the display.
  - ✓ Once the rinse cycle has run through to the end, an audible signal will sound.

### Running the second rinse cycle

1. Open the control panel and remove the water tank.
2. Thoroughly rinse the water tank and fill it with fresh water.
3. Slide in the water tank and close the control panel.
4. Press  to start the rinse cycle.
  - ✓ The rinse cycle will start. The duration will count down on the display.
  - ✓ Once the rinse cycle has run through to the end, an audible signal will sound.
5. Empty and dry the water tank.  
→ *"Emptying the water tank"*, Page 15

## 19 Rails

To thoroughly clean the rails and the cooking compartment, or to replace the rails, you can remove the rails.

### 19.1 Detaching the rails

**⚠ WARNING – Risk of burns!**

The shelf supports get very hot

- ▶ Never touch the shelf supports when hot.
- ▶ Always allow the appliance to cool down.
- ▶ Keep children at a safe distance.

1. Lift the rail forwards slightly ① and detach it ②.
2. Pull the whole rail to the front ③ and remove it.

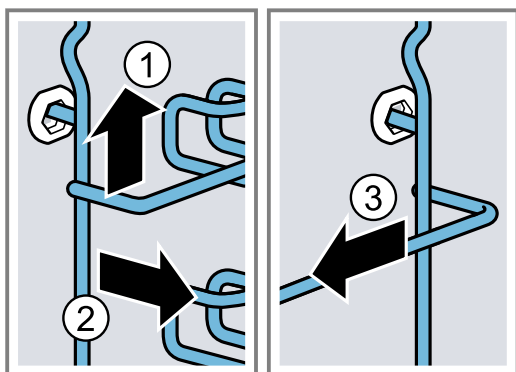

3. Clean the rail.  
→ "Cleaning products", Page 24

### 19.2 Attaching the rails

**Notes**

- The rails only fit on the right or left.
  - For both rails, ensure that the retaining bracket is at the front.
1. First, push the rail into the middle of the rear socket ① until the rail rests against the cooking compartment wall, and then push this back ②.
  2. Push the rail into the front socket ③ until the rail also rests against the cooking compartment wall, and then press this downwards ④.

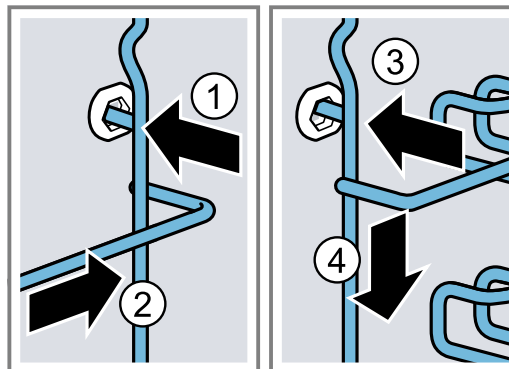

## 20 Appliance door

To clean the appliance door thoroughly, you can disassemble the appliance door.

### 20.1 Detaching the appliance door

**⚠ WARNING – Risk of injury!**

Components inside the appliance door may have sharp edges.

- ▶ Wear protective gloves.

The hinges on the appliance door move when the door is opened and closed, which could trap your fingers.

- ▶ Keep your hands away from the hinges.

1. Open the appliance door fully.



**2. ⚠ WARNING – Risk of injury!**

When the hinges are not secured, they can snap shut with great force.

- ▶ Make sure that the locking levers are always either fully closed or (when detaching the oven door) fully open.

Open the locking levers on the left- and right-hand hinges.

Locking levers opened

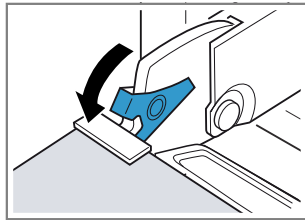

The hinge is now secured and cannot snap shut.

Locking levers closed

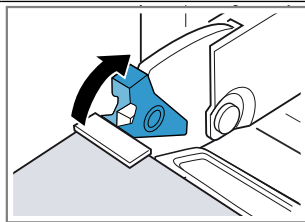

The appliance door is secured and cannot be detached.

- ✓ The locking levers are open. The hinges are now secured and cannot snap shut.

- 3.** Close the appliance door fully ①. Grab hold of the appliance door with both hands (on the left and right) and pull it upwards and out ②.

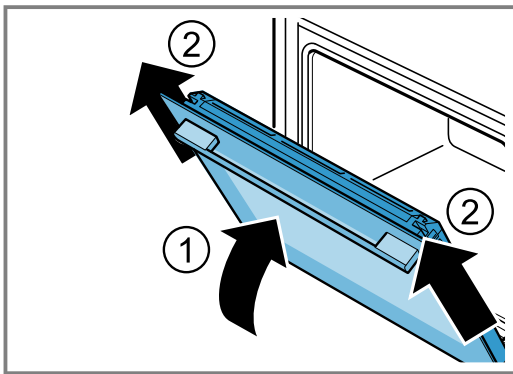

- 4.** Carefully place the appliance door on a level surface.

## 20.2 Attaching the appliance door

**⚠ WARNING – Risk of injury!**

The hinges on the appliance door move when the door is opened and closed, which could trap your fingers.

- ▶ Keep your hands away from the hinges.

When the hinges are not secured, they can snap shut with great force.

- ▶ Make sure that the locking levers are always either fully closed or (when detaching the oven door) fully open.

- 1.** If the seal becomes detached during cleaning, press down on the seal along the drip trough.

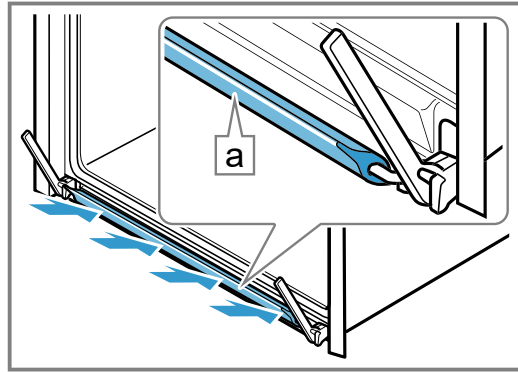

- 2.** Slide the appliance door straight onto the two hinges ①. Slide the appliance door on as far as it will go.
- 3.** Open the appliance door fully.
- 4.** Close the locking levers on the left- and right-hand hinges ②.

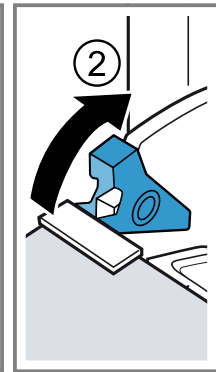
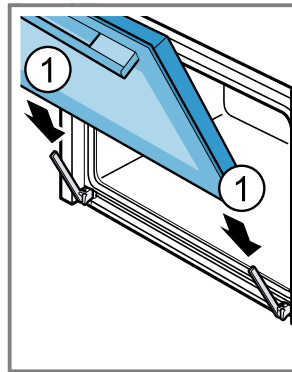

- ✓ The locking levers are closed. The appliance door is secured and cannot be detached.

- 5.** Close the appliance door.

## 20.3 Removing the door panes

**⚠ WARNING – Risk of injury!**

The hinges on the appliance door move when the door is opened and closed, which could trap your fingers.

- ▶ Keep your hands away from the hinges.

Components inside the appliance door may have sharp edges.

- ▶ Wear protective gloves.

- 1.** Open the appliance door fully.
- 2.** Open the locking levers on the left- and right-hand hinges ①.

- ✓ The locking levers are open. The hinges are now secured and cannot snap shut.

3. Close the appliance door fully ②.

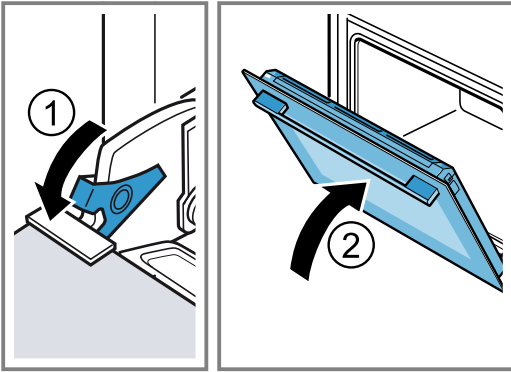

4. Push on the left- and right-hand side of the door cover from the outside ① until it is released.

5. Remove the door cover ②.

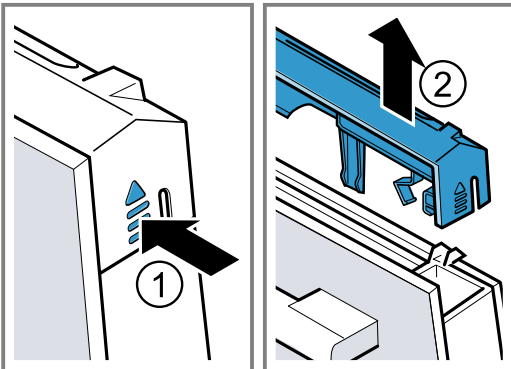

6. Lift out the inner pane ① and set it down carefully on a flat surface.

7. Lift out the intermediate pane ② and set it down carefully on a flat surface.

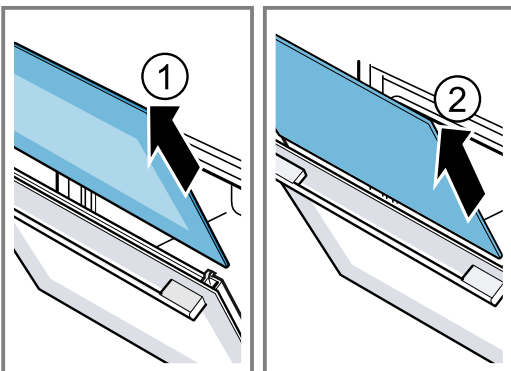

8. Open the appliance door and remove the door seal.

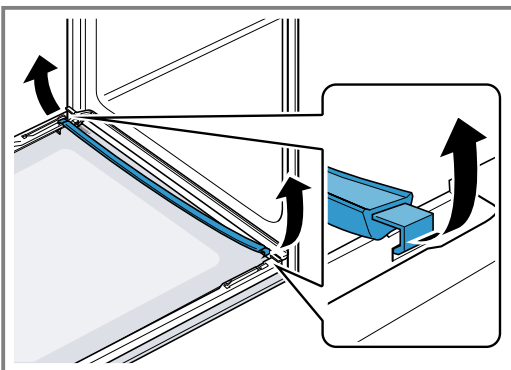

9. If necessary, you can remove the condensate trough for cleaning.
- Open the appliance door.
  - Tilt the condensate trough upwards and remove it.

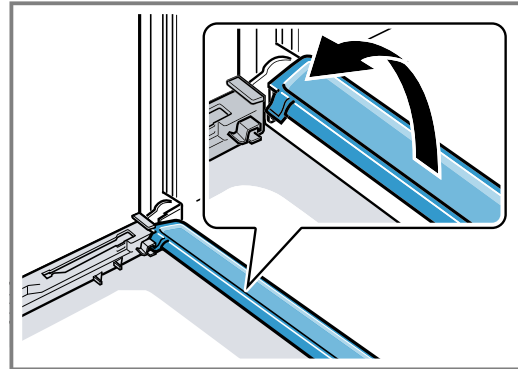

10. **⚠ WARNING – Risk of injury!**

Scratched glass in the appliance door may develop into a crack.

- ▶ Do not use any harsh or abrasive cleaners or sharp metal scrapers to clean the glass on the oven door, as they may scratch the surface.

Clean the removed door panes on both sides with glass cleaner and a soft cloth.

11. Clean the condensate trough with a cloth and hot soapy water.

12. Clean the appliance door.

→ "Suitable cleaning agents", Page 24

13. Dry the door panes and refit them.

## 20.4 Fitting the door panes

- ⚠ WARNING – Risk of injury!**

The hinges on the appliance door move when the door is opened and closed, which could trap your fingers.

- ▶ Keep your hands away from the hinges.
- Components inside the appliance door may have sharp edges.

- ▶ Wear protective gloves.

1. Open the appliance door fully.

2. Place the condensate trough vertically into the retainer **a** and turn it downwards.

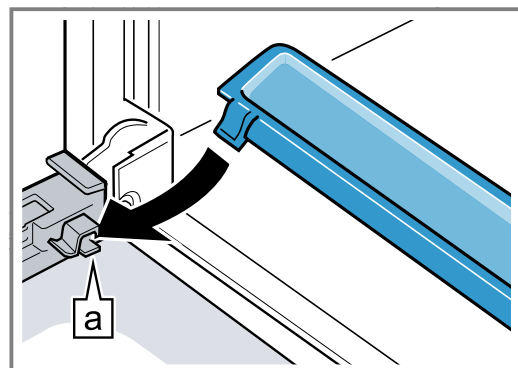

3. Slide the intermediate pane into the left- and right-hand retainers [a].

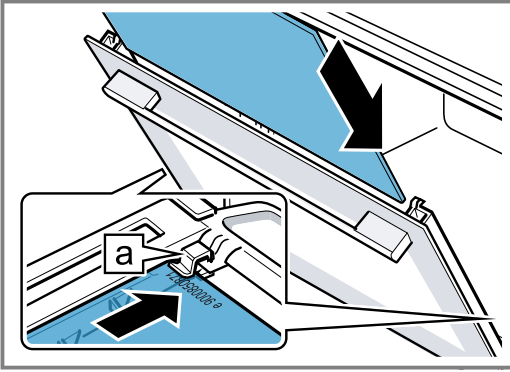

4. Push the intermediate pane upwards until it is in the left- and right-hand retainers [a].

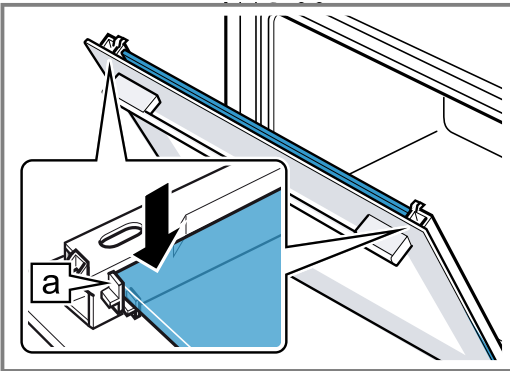

5. Open the appliance door and attach the door seal.

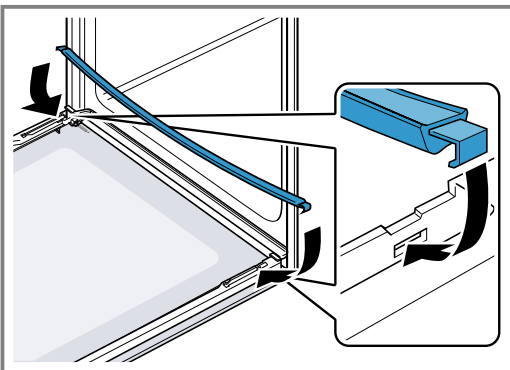

6. Slide the inner pane into the left- and right-hand retainers [a].

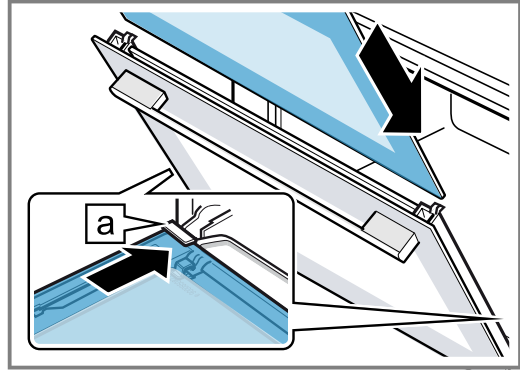

7. Push the inner pane upwards until it is in the left- and right-hand retainers [a].

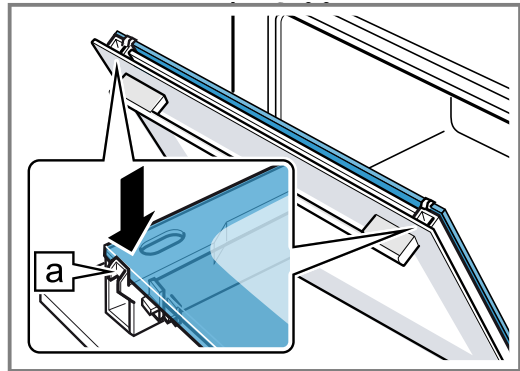

8. Put the door cover in position ① and push down on it until you hear it click into place.  
9. Open the appliance door fully.  
10. Close the locking levers on the left- and right-hand hinges ②.

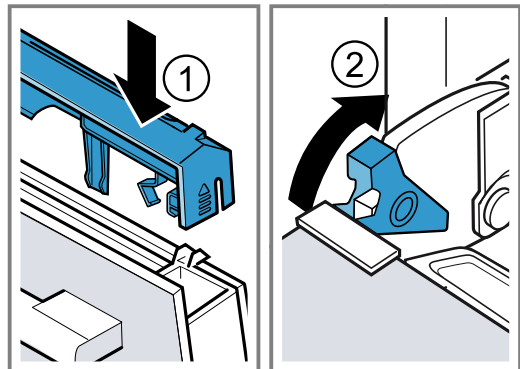

- ✓ The locking levers are closed. The appliance door is secured and cannot be detached.

11. Close the appliance door.

**Note:** Do not use the cooking compartment again until the door panes have been correctly fitted.

## 21 Troubleshooting

You can rectify minor faults on your appliance yourself. Read the troubleshooting information before contacting after-sales service. This will avoid unnecessary costs.

### **⚠ WARNING – Risk of injury!**

Improper repairs are dangerous.



- ▶ Repairs to the appliance should only be carried out by trained specialist staff.
- ▶ If the appliance is defective, call Customer Service.

### **WARNING – Risk of electric shock!**

Incorrect repairs are dangerous.

- ▶ Repairs to the appliance should only be carried out by trained specialist staff.
- ▶ Only use genuine spare parts when repairing the appliance.
- ▶ If the power cord of this appliance is damaged, it must be replaced by trained specialist staff.

## 21.1 Malfunctions

Fault	Cause and troubleshooting
The appliance is not working.	The circuit breaker is faulty. <ul style="list-style-type: none"> <li>▶ Check the circuit breaker in the fuse box.</li> </ul> <hr/> There has been a power cut. <ul style="list-style-type: none"> <li>▶ Check whether the lighting in your kitchen or other appliances are working.</li> </ul>
"Language English" appears on the display.	There has been a power cut. <ul style="list-style-type: none"> <li>▶ Configure the initial configuration settings. → <i>"Initial use", Page 11</i></li> </ul>
The appliance cannot be switched on;  appears on the display.	Automatic childproof lock or childproof lock is activated <ul style="list-style-type: none"> <li>▶ Press and hold the  button until "Childproof lock deactivated" appears on the display.</li> </ul>
Appliance will not start or cuts out during operation.	Different causes are possible. <ul style="list-style-type: none"> <li>▶ Check any notifications that appear on the display. → <i>"Displaying information", Page 13</i></li> </ul> <hr/> Malfunction <ul style="list-style-type: none"> <li>▶ Call the after-sales service. → <i>"Customer Service", Page 35</i></li> </ul>
The appliance is not heating;  appears on the display.	Demo mode is activated in the basic settings. <ol style="list-style-type: none"> <li>1. Briefly disconnect the appliance from the power supply by switching the circuit breaker in the fuse box off and then on again.</li> <li>2. Deactivate Demo mode within the next 3 minutes in the → <i>"Basic settings", Page 21.</i></li> </ol> <hr/> There has been a power cut. <ul style="list-style-type: none"> <li>▶ Open and close the appliance door once after a power failure.</li> <li>✓ The appliance will perform a self-test, after which it will be ready to use.</li> </ul>
Time not displayed when appliance switched off.	Basic setting has been changed. <ul style="list-style-type: none"> <li>▶ Change the basic setting for the clock display. → <i>"Basic settings", Page 21</i></li> </ul>
HomeConnect is not working correctly.	Different causes are possible. <ul style="list-style-type: none"> <li>▶ Go to <a href="http://www.home-connect.com">www.home-connect.com</a>.</li> </ul>
The control panel cannot be opened.	The circuit breaker is faulty. <ul style="list-style-type: none"> <li>▶ Check the circuit breaker in the fuse box.</li> </ul> <hr/> There has been a power cut. <ul style="list-style-type: none"> <li>▶ Check whether the lighting in your kitchen or other appliances are working.</li> </ul> <hr/> Malfunction <ol style="list-style-type: none"> <li>1. Call the after-sales service. → <i>"Customer Service", Page 35</i></li> <li>2. If there is water in the water tank, empty the water tank:                             <ul style="list-style-type: none"> <li>- Open the appliance door.</li> <li>- Grip on the right and left below the control panel.</li> <li>- Slowly pull out the control panel and push it upwards.</li> </ul> </li> </ol>
Intense steam generation when steaming.	The appliance is automatically calibrated. No action required.

Fault	Cause and troubleshooting
Intense steam generation when steaming.	<p>If the cooking times are too short, the appliance is not automatically calibrated. If a lot of steam is generated repeatedly, the appliance is recalibrated.</p> <ol style="list-style-type: none"> <li>1. Reset the appliance to the factory setting. → <i>"Basic settings", Page 21</i></li> <li>2. Repeat the calibrations. → <i>"Before using for the first time", Page 11</i></li> </ol>
Steam escaping from ventilation slots during cooking	<p>Escaping steam is not a fault. No action required.</p>
The appliance requests descaling without the counter appearing in advance.	<p>The set water hardness range is too low.</p> <ol style="list-style-type: none"> <li>1. Descal the appliance. → <i>"Descaling", Page 28</i></li> <li>2. Check the water hardness and set this in the basic settings. → <i>"Basic settings", Page 21</i></li> </ol>
The appliance prompts you to rinse it.	<p>During the descaling, the power supply is interrupted or the appliance is switched off.</p> <ul style="list-style-type: none"> <li>▶ Rinse the appliance twice. → <i>"Descaling", Page 28</i></li> </ul>
"Fill water tank" appears in the display even though the water tank has been filled.	<p>The water tank has not clicked into place.</p> <ul style="list-style-type: none"> <li>▶ Insert the water tank correctly so that it engages in the holder. → <i>"Filling the water tank", Page 13</i></li> </ul>
	<p>The water tank has fallen out. Shaking has caused parts to come loose in the water tank. The water tank is leaking.</p> <ul style="list-style-type: none"> <li>▶ Order a new water tank.</li> </ul>
	<p>Malfunction</p> <ul style="list-style-type: none"> <li>▶ Do not use deionised or filtered water. → <i>"Before using for the first time", Page 11</i></li> </ul>
	<p>The sensor is defective.</p> <ul style="list-style-type: none"> <li>▶ Call the after-sales service. → <i>"Customer Service", Page 35</i></li> </ul>
Buttons are flashing.	<p>Condensation has formed behind the control panel. No action required. As soon as the condensation has evaporated, the buttons no longer flash.</p>
"Plopping" sounds can be heard when cooking with steam.	<p>Water vapour requires the cold/heat effect for frozen food. No action required.</p>
The appliance hums during operation and after it is switched off.	<p>Functional test of the pump creates operating noise. No action required.</p>
The appliance hums or clicks when the control panel is opened.	<p>Removing the control panel creates operating noise. No action required.</p>
The interior lighting does not work.	<p>The LED light is defective.</p> <p><b>Note:</b> Do not remove the glass cover.</p> <ul style="list-style-type: none"> <li>▶ Call the after-sales service. → <i>"Customer Service", Page 35</i></li> </ul>
Maximum operating time reached.	<p>To prevent the appliance from continuing to run when it is no longer needed, it automatically stops heating after a few hours if the settings are not changed during this time. A notification appears on the display. The point at which the maximum operating time is reached is determined by the corresponding settings for an operating mode.</p> <ol style="list-style-type: none"> <li>1. Press any button to continue operation.</li> <li>2. If you do not need to use the appliance, press  to switch it off.</li> </ol> <p><b>Tip:</b> To prevent the appliance from switching off when you do not want it to, set a cooking time. → <i>"Setting the cooking time", Page 17</i></p>

Fault	Cause and troubleshooting
A message with "D" or "E" appears in the display, e.g. D0111 or E0111.	<p>The electronics have detected a fault.</p> <ol style="list-style-type: none"> <li>1. Switch the appliance off and on again.</li> <li>✓ If the fault was a one-off, the message disappears.</li> <li>2. If the message appears again, call the after-sales service. Please specify the exact error message when calling. → "Customer Service", Page 35</li> </ol>
The cooking result is not satisfactory.	<p>Settings were unsuitable. Setting values, e.g. temperature or cooking time, depend on the recipe, quantity and food.</p> <ul style="list-style-type: none"> <li>▶ Next time, set lower or higher values.</li> </ul> <p><b>Tip:</b> A lot of information about the food preparation and corresponding setting values can be found on our website <a href="http://www.neff-international.com">www.neff-international.com</a>.</p>

## 22 Disposal

Find out here how to dispose of old appliances correctly.

### 22.1 Disposing of old appliance

Valuable raw materials can be reused by recycling.

1. Unplug the appliance from the mains.
2. Cut through the power cord.
3. Dispose of the appliance in an environmentally friendly manner.

Information about current disposal methods are available from your specialist dealer or local authority.



This appliance is labelled in accordance with European Directive 2012/19/EU concerning used electrical and electronic appliances (waste electrical and electronic equipment - WEEE).

The guideline determines the framework for the return and recycling of used appliances as applicable throughout the EU.

## 23 Customer Service

If you have any queries on use, are unable to rectify faults on the appliance yourself or if your appliance needs to be repaired, contact Customer Service. Function-relevant genuine spare parts according to the corresponding Ecodesign Order can be obtained from Customer Service for a period of at least 10 years from the date on which your appliance was placed on the market within the European Economic Area.

**Note:** Under the terms of the manufacturer's warranty the use of Customer Service is free of charge.

Detailed information on the warranty period and terms of warranty in your country is available from our after-sales service, your retailer or on our website.

If you contact Customer Service, you will require the product number (E-Nr.) and the production number (FD) of your appliance.

The contact details for Customer Service can be found in the enclosed Customer Service directory or on our website.

This product contains light sources from energy efficiency class G. These light sources are available as a spare part and should only be replaced by trained specialist staff.

### 23.1 Product number (E-Nr.) and production number (FD)

You can find the product number (E-Nr.) and the production number (FD) on the appliance's rating plate. On some appliances with steam-assisted cooking, you will find the rating plate behind the control panel.

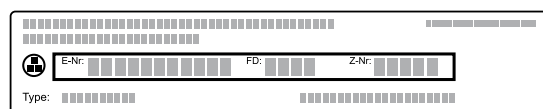

Make a note of your appliance's details and the Customer Service telephone number to find them again quickly.



## 24 Declaration of Conformity

Constructa Neff Vertriebs-GmbH hereby declares that the appliance with Home Connect functionality conforms to the basic requirements and other relevant provisions of Directive 2014/53/EU.

A detailed RED Declaration of Conformity can be found online at [www.neff-international.com](http://www.neff-international.com) among the additional documents on the product page for your appliance.



Hereby, Constructa Neff Vertriebs-GmbH declares that the appliance with Home Connect functionality is in compliance with relevant statutory requirements.

A detailed Declaration of Conformity can be found online at [www.neff-home.com/uk](http://www.neff-home.com/uk) among the additional documents on the product page for your appliance.



Only applies to Great Britain

2.4 GHz band (2400–2483.5 MHz): Max. 100 mW

5 GHz band (5150–5350 MHz + 5470–5725 MHz):

Max. 100 mW

	BE	BG	CZ	DK	DE	EE	IE	EL	ES
	FR	HR	IT	CY	LI	LV	LT	LU	HU
	MT	NL	AT	PL	PT	RO	SI	SK	FI
	SE	NO	CH	TR	IS	UK (NI)			

5 GHz WLAN (Wi-Fi): For indoor use only.

AL	BA	MD	ME	MK	RS	UK	UA
----	----	----	----	----	----	----	----

5 GHz WLAN (Wi-Fi): For indoor use only.

## 25 How it works

Here, you can find the ideal settings for various types of food as well as the best accessories and cookware. We have perfectly tailored these recommendations to your appliance.

### 25.1 General cooking tips

Please take note of the following information when cooking all types of food.

- The temperature and cooking time depend on the amount of food and the recipe. Settings ranges are specified for this reason. Try using the lower values to start with.
- The setting values apply to food placed in the cooking compartment while the cooking compartment is still cold. Do not place accessories into the cooking compartment until it has finished preheating.
- Remove any accessories that are not being used from the cooking compartment.

### 25.2 Baking tips

- Dark-coloured metal baking tins are most suitable for baking cakes, bread and other baked goods.
- Use wide, shallow cookware for bakes and gratins. Food takes longer to cook in deep, narrow cookware and it browns more on top.
- Silicone moulds are not suitable.
- If you are cooking bakes directly in the universal pan, place the universal pan into the cooking compartment at level 1.
- The setting values for bread dough apply to both dough placed on a baking tray and dough placed in a loaf tin.

### ATTENTION!

When the cooking compartment is hot, any water inside it will create steam. The change in temperature may cause damage.

- ▶ Never pour water into the cooking compartment when it is still hot.
- ▶ Never place cookware containing water on the cooking compartment floor.

### Shelf positions

If you bake on one level, use shelf position 1.

Baking on 2 levels	Shelf position
Universal pan	3
Baking tray	1
Baking tins on two wire racks	3
	1

Use the CircoTherm hot air heating function.

### Notes

- Items that are placed in the appliance on baking trays or in baking tins/dishes at the same time will not necessarily be ready at the same time.
- If you opt for steam-assisted cooking, you can only cook on one level.

### 25.3 Roasting, braising and grilling tips

- The recommended settings are for fridge-temperature food and unstuffed, oven-ready poultry.
- Place the poultry onto the cookware breast-side or skin-side down.

- Turn roasting joints, grilled items or whole fish after approx.  $\frac{1}{2}$  to  $\frac{2}{3}$  of the specified time.

Calculating the cooking time, e.g. 20+35:

- To calculate the cooking time, assume 20 minutes per 500 g of meat. Then add an extra 35 minutes to that figure.
- For 1.5 kg, the cooking time would therefore be 95 minutes.

Cooking time range, e.g. 10-15:

- Your food will be ready within the specified range of time (in minutes).

### Roasting on the wire rack

Food roasted on the wire rack will become very crispy on all sides. You can roast large poultry, for example, or multiple individual pieces at the same time.

- Roast pieces of a similar weight and thickness. The grilled food will brown evenly and will remain succulent and juicy.
- Place the food to be roasted directly on the wire rack.
- To catch any liquids that drip down, place the universal pan, with the wire rack inside it, into the cooking compartment at the specified shelf height.
- Add up to  $\frac{1}{2}$  litre of water to the universal pan, depending on the size and type of food that you want to roast.

You can make a sauce from the juices that are collected. This also means that less smoke is produced and the cooking compartment does not become as dirty.

### Roasting in cookware

If you cover the cookware when you cook your food, this will keep the cooking compartment cleaner.

#### General information about roasting in cookware

- Use heat-resistant, ovenproof cookware.
- Place the cookware on the wire rack.
- Glass cookware is best.
- Follow the manufacturer's instructions for your roasting dishes.

#### Roasting in uncovered cookware

- Use a deep roasting dish.
- If you do not have any suitable cookware, you can use the universal pan.

#### Roasting in covered cookware

- Use a suitable lid that seals well.
- When roasting meat, there should be at least 3 cm between the food and the lid. The meat may expand.

#### **WARNING – Risk of scalding!**

Very hot steam may escape when the lid is opened after cooking. Steam may not be visible, depending on the temperature.

- ▶ Lift the lid in such a way that the hot steam can escape away from you.
- ▶ Keep children away from the appliance.

### Grilling

Grill food if you want it to be crispy.

The "Grill" heating function is good for cooking thinner pieces of poultry, meat and fish such as steaks, drumsticks and burgers. It is also excellent for toasting bread.

Circo-roasting is very well suited to cooking whole poultry and fish, as well as meat, e.g. roast pork with crackling.

- When grilling several food items, choose pieces that are of a similar weight and thickness. The grilled food will brown evenly and will remain succulent and juicy.
- Place the food to be grilled directly onto the wire rack.
- To catch any liquids that drip down, place the universal pan into the cooking compartment at least one level below the wire rack.

#### Notes

- The grill element switches on and off continuously. This is normal. The temperature that you set determines how frequently this occurs.
- Smoke may be produced when grilling.

## 25.4 Cooking instructions for ready meals

- The cooking result greatly depends on the quality of the food. Pre-browning and irregularities are sometimes already present on the raw product.
- Do not use frozen products that are covered with a thick layer of ice. Remove any ice on the food.
- Distribute foods that are in the form of separate pieces, such as bread rolls and potato products, so that they are spread out flat and evenly on the accessory. Leave a little space between the individual pieces.
- Follow the manufacturer's instructions on the packaging.

## 25.5 Steaming

Cook dishes gently. The food remains particularly succulent.

In contrast to steam-assisted cooking, the meat does not become crispy on the outside.

- Use open, heat-resistant cookware that is suitable for cooking with steam.
- The perforated steam container (size XL) is the best option here. To catch any liquid that drips down, slide in the universal pan one level below in the cooking compartment.  
You can also use a glass tray and place this onto the wire rack.
- Cover food that can normally be cooked in a water bath, with film, e.g. with cling film.
- You do not need to turn the food.
- For a different flavour, you can sear the meat, poultry or fish before steaming. Reduce the cooking time.
- Larger pieces require a longer heating-up time and a longer cooking time.
- If you are using several pieces which are the same weight, the appliance's heating-up time is increased. The cooking time remains the same.
- In the main part of the instruction manual, you can find information on how to set the steam function.  
→ "Steam", Page 13

### Vegetables on several levels

You can easily cook more than one type of food or even whole menus, e.g. broccoli and potatoes, on two levels.

### Rice or cereals

- Add water or liquid in the indicated ratio. For example, this means 1:1.5 for 100 g of rice, 150 ml liquid.

## 25.6 List of foods

Recommended settings for a variety of foods, sorted into food categories.

### Recommended settings for various types of food

Food	Accessories/cook-ware	Shelf position	Heating function → Page 7	Temperature in °C	Steam intensity	Cooking time in mins
Victoria sponge cake	x 2 Baking tin, dia. 20 cm	1		160–170 <sup>1</sup>	-	20–30
Victoria sponge cake	x 2 Baking tin, dia. 20 cm	1		150–160	Added steam, low	25–35
Rich fruit cake	High Ø 23 cm tin	1		140–160	-	120–180
Fruit pie	Plate Ø 20 cm or Pie tin	1		180–190	-	45–50
Fruit pie	Plate Ø 20 cm or Pie tin	1		170–190	-	55–70
Fruit pie	Plate Ø 20 cm or Pie tin	1		170–190	-	60–75
Quiche	Dark coated quiche tin	1		190–200	-	35–45
Bread or white bread	Loaf tin, 1 x 900 g or 2 x 450 g	1		190–210 <sup>1</sup>	-	20–30
Bread or white bread	Loaf tin, 1 x 900 g or 2 x 450 g	1		<b>1.</b> 210–220 <b>2.</b> 180–190	Added steam, high	<b>1.</b> 10–15 <b>2.</b> 25–35
Bread or white bread	Loaf tin, 1 x 900 g or 2 x 450 g	1		190–200	-	45–55
Scones	Baking tray	1		180–200 <sup>1</sup>	-	10–14
Biscuits	Baking tray	2		140–160 <sup>1</sup>	-	10–25
Small cakes	12-cup-tin	1		140–160 <sup>1</sup>	-	20–35
Small cakes	12-cup-tin	1		150–170	-	20–30
Pavlova	Baking tray	2		90–100 <sup>1</sup>	-	120–180
Yorkshire pudding	12-cup-tin	1		200–220 <sup>1</sup>	-	15–25
Pizza, home-made	Baking tray	1		200–220	-	20–30
Pizza, home-made, thin crust	Pizza tray	1		210–230	-	20–30

<sup>1</sup> Preheat the appliance.

<sup>2</sup> Bone side down

<sup>3</sup> Do not turn

<sup>4</sup> Add the food after approx. one hour.

<sup>5</sup> Preheat the appliance for 5 minutes.

<sup>6</sup> Preheat the appliance for three minutes.

<sup>7</sup> Turn the dish several times.

Food	Accessories/cook-ware	Shelf position	Heating function → Page 7	Temperature in °C	Steam intensity	Cooking time in mins
Victoria sponge cake, 2 levels	4 pcs Baking tin, dia. 20 cm	3+1		160–170 <sup>1</sup>	-	20–35
Biscuits, 2 levels	2 pcs Baking tray	3+1		140–160 <sup>1</sup>	-	15–30
Top side, top rump	Wire rack	1		160 - 170	-	30 + 25
Top side, top rump	Wire rack	1		170 - 180	Added steam, low	100 - 120
Leg, bone-in	Wire rack	1		160 - 170	-	25 + 25
Leg, bone-in, 1.5 kg	Wire rack	1		180 - 190	Added steam, low	80 - 90
Belly	Wire rack	1		170 - 180	-	30 + 25
Chicken, whole	Wire rack	1		170 - 180	-	25 + 15
Chicken, whole, 1.5 kg	Wire rack	1		180 - 190	Added steam, medium	65 - 75
Turkey, crown <sup>2</sup>	Wire rack	1		150 - 160	-	20 + 15 <sup>3</sup>
Turkey, crown, 3 kg	Uncovered cook-ware	1		140 - 150	Added steam, medium	100 - 140
Turkey, whole, 4-8 kg	Wire rack	1		150 - 160	-	12 + 12 <sup>4</sup>
Turkey, whole, 7 kg	Universal pan	1		<b>1.</b> 140 - 150 <b>2.</b> 170 - 180	Added steam, medium -	<b>1.</b> 120 - 150 <b>2.</b> 30 - 40
Complete meal with chicken	Wire rack + Wire rack	3+1		180	-	Calculation for chicken (see table above)
Complete meal with chicken	Wire rack + Wire rack	3+1		180	Added steam, low Steam 0 when yorkshire pudding is placed in the oven	65 - 75
Bacon rashers	Wire rack	2		275 <sup>5</sup>	-	<b>1.</b> First side 5-6 <b>2.</b> Second side 4-5
Sausages, 2-4 cm thick	Wire rack	2		275 <sup>6</sup>	-	10 - 15 <sup>7</sup>
Belly	Wire rack	1		200 - 220	-	30 + 25

<sup>1</sup> Preheat the appliance.

<sup>2</sup> Bone side down

<sup>3</sup> Do not turn

<sup>4</sup> Add the food after approx. one hour.

<sup>5</sup> Preheat the appliance for 5 minutes.

<sup>6</sup> Preheat the appliance for three minutes.

<sup>7</sup> Turn the dish several times.

Food	Accessories/cook-ware	Shelf position	Heating function → <b>Page 7</b>	Temperature in °C	Steam intensity	Cooking time in mins
Belly, 1 kg	Wire rack	1		<b>1.</b> 170 - 180 <b>2.</b> 190 - 200	Added steam, low -	<b>1.</b> 50 - 60 <b>2.</b> 25 - 35
Gammon joint	Wire rack	2		180 - 200	-	30 + 25
Chicken, whole	Wire rack	1		200 - 220	-	25 + 15
Chicken, whole, 1.5 kg	Wire rack	1		180 - 190	Added steam, medium	65 - 75
Chicken breast, 150 g each	Steaming tray	2		100	-	15-25
Fish, whole 300 g, e.g. trout	Perforated steaming tray	2		80-90	-	15-25
Fish fillet, 200 g	Perforated steaming tray	2		80-100	-	10-16
Unpeeled boiled potatoes	Perforated steaming tray	2		100	-	35-45
Cauliflower, whole	Perforated steaming tray	2		100	-	25-35
Carrots, slices	Perforated steaming tray	2		100	-	10-20
Spinach	Perforated steaming tray	2		100	-	2-3
Long-grain rice, 1:1.5	Shallow cookware	1		100	-	20-30
Hard-boiled eggs	Perforated steaming tray	2		100	-	9-11
Crème Brulée	Individual moulds	1		85	-	20-30
Crème caramel	Individual moulds	1		85	-	25-35
<b>1.</b> Boiled potatoes <b>2.</b> Frozen salmon fillet <b>3.</b> Broccoli florets	<b>1.</b> Perforated steaming tray, size S, on the wire rack <b>2.</b> Unperforated steaming tray, size S, on the wire rack <b>3.</b> Perforated steaming tray, size XL	<b>1.</b> 3 <b>2.</b> 3 <b>3.</b> 2		100	-	<b>1.</b> 25 <b>2.</b> 20 <b>3.</b> 9
Yoghurt	Individual moulds	Cooking compartment floor		1	-	300 - 360

<sup>1</sup> Preheat the appliance.

<sup>2</sup> Bone side down

<sup>3</sup> Do not turn

<sup>4</sup> Add the food after approx. one hour.

<sup>5</sup> Preheat the appliance for 5 minutes.

<sup>6</sup> Preheat the appliance for three minutes.

<sup>7</sup> Turn the dish several times.

## 25.7 Special cooking methods and other applications

Information and recommended settings for special cooking methods and other applications, e.g. slow cooking or preserving.

### Slow cooking

Cook prime cuts of meat slowly at a low temperature, e.g. tender cuts of beef, veal, lamb or poultry.

### Slow cooking poultry or meat

**Note:** When using the Slow cooking heating function, you cannot delay the start of the program by setting an end time.

**Requirement:** The cooking compartment must be cold.

1. Use fresh, clean, hygienic meat without bones.
2. Place the cookware onto the wire rack at level 1 in the cooking compartment.





3. Preheat the cooking compartment and cookware for approx. 15 minutes.
4. Sear the meat on all sides on the hob at a very high heat.
5. Immediately place the meat into the pre-warmed cookware in the cooking compartment.  
To ensure that the climate in the cooking compartment remains constant, keep the cooking compartment door closed during slow cooking.
6. After slow cooking, remove the meat from the cooking compartment.

### Tips for slow cooking

Here you will find tips for achieving good results when slow cooking food.

Issue	Tip
You want to slow cook a duck breast.	<ul style="list-style-type: none"> <li>■ Place the cold duck breast into a pan.</li> <li>■ Sear the skin side first.</li> <li>■ Slow cook the duck breast.</li> <li>■ After slow cooking, grill the duck breast for 3 to 5 minutes until crispy.</li> </ul>
You want to serve your slow-cooked meat as hot as possible.	<ul style="list-style-type: none"> <li>■ Preheat the serving plate.</li> <li>■ Make sure that the sauces that accompany the duck breast are very hot when you serve them.</li> </ul>

### Recommended settings for slow cooking

Food	Accessory/cookware	Shelf position	Searing time in mins	Heating function → Page 7	Temperature in °C	Cooking time in mins
Duck breast, medium rare, 300 g each	Uncovered cookware	1	6 - 8		95 <sup>1</sup>	45 - 60
Fillet of pork, whole	Uncovered cookware	1	4 - 6		85 <sup>1</sup>	45 - 70
Fillet of beef, 1 kg	Uncovered cookware	1	4 - 6		85 <sup>1</sup>	90 - 120
Veal medallions, 4 cm thick	Uncovered cookware	1	4		80 <sup>1</sup>	40 - 60
Saddle of lamb, boneless, 200 g each	Uncovered cookware	1	4		85 <sup>1</sup>	30 - 45

<sup>1</sup> Preheat the appliance.

### Proving dough

Always allow dough to prove in two steps: Once in their entirety (1. - dough fermentation) and a second time when shaped (2. - final fermentation).

**Requirement:** The cooking compartment is cold.

#### 1. Dough fermentation:

- Slide the wire rack into the cooking compartment.
- Place the dough in a bowl onto the wire rack.









- Use the recommended settings when configuring the appliance settings.
- Do not open the appliance door while the dough is proving, otherwise moisture will escape.

#### 2. Final fermentation:

- Continue processing the dough and turn it into the final shape for baking.
- Place the dough in the specified shelf position.

#### 3. Wipe the cooking compartment dry before baking.

### Recommended settings for proving dough

Food	Accessory/cookware	Shelf position	Heating function → Page 7	Temperature in °C	Cooking time in mins
Rich dough, e.g. panettone	Bowl on wire rack	1. 1	1. 	1. 40-45	1. 40-90
	Tin/dish on the wire rack	2. 1	2. 	2. 40-45	2. 30-60
Rich dough, e.g. panettone	Bowl on wire rack	1. 1	1. 	1. 2	1. 40-90
	Tin/dish on the wire rack	2. 1	2. 	2. 2	2. 30-60
White bread	Bowl on wire rack	1. 1	1. 	1. 35-40	1. 30-40
	Universal pan	2. 1	2. 	2. 35-40	2. 15-25
White bread	Bowl on wire rack	1. 1	1. 	1. 1	1. 30-40
	Universal pan	2. 1	2. 	2. 1	2. 15-25



## Defrosting

You can defrost frozen food in your appliance.

### Tips for defrosting food

- The Defrost function is suitable for defrosting frozen fruit and vegetables.
- Use the CircoTherm hot air heating function to defrost baked goods.
- It is better to defrost poultry, meat and fish in the refrigerator.
- Remove frozen food from its packaging before you defrost it.
- Accessory/cookware:
  - Place frozen fruit and vegetables into the perforated steaming tray (size XL). To catch any liquids that drip down, place the universal pan into the cooking compartment below the steaming tray.
  - Frozen food for which the liquid is an integral component and needs to be retained (e.g. frozen creamed spinach) should be placed into the universal pan or into a piece of cookware that is then placed onto the wire rack.
  - Place baked goods directly onto the wire rack.

- The recommended settings are for freezer-temperature food (-18 °C).



## Reheating

You can use steam-assisted reheating to gently warm up food. The food tastes and looks as though it has been freshly cooked. You can even warm and crisp up baked goods from the day before.

### Tips for reheating food

- Use uncovered, heat-resistant cookware that is suitable for cooking with steam.
- Use wide, shallow cookware. Reheating takes longer if you use cold cookware.
- Place the cookware on the wire rack.
- Place food that you are not reheating in cookware (e.g. bread rolls) directly onto the wire rack at level 1.
- Do not cover the food.
- Do not open the cooking compartment door while the food is being reheated, otherwise large amounts of steam will escape.
- Wipe the cooking compartment dry after using it to reheat food.

### Recommended settings for reheating

Food	Accessories/cookware	Shelf position	Heating function → Page 7	Temperature in °C	Steam intensity	Cooking time in mins
Pizza, cooked	Wire rack	1		170 - 180 <sup>1</sup>	-	5 - 15
Bread rolls, baguette, baked	Wire rack	1		160 - 170 <sup>1</sup>	-	10 - 20

<sup>1</sup> Preheat the appliance.



## 25.8 Test dishes

The information in this section is provided for test institutes to facilitate testing of the appliance in accordance with EN 60350-1.

### Baking







- The setting values apply to food that is placed into a cold cooking compartment.
- Please take note of the information on preheating in the recommended settings tables. These setting values assume that the rapid heat-up function is not being used.
- For baking, use the lower of the specified temperatures to start with.
- Items that are placed in the appliance on baking trays or in baking tins/dishes at the same time will not necessarily be ready at the same time.
- Shelf positions when baking on 2 levels:
  - Universal pan: Shelf position 3
  - Baking tray: Shelf position 1
- Hot water sponge cake
  - When baking on two levels, place the springform tins at diagonally opposite corners of the wire racks.

### Recommended settings for baking

Food	Accessories/cookware	Shelf position	Heating function → Page 7	Temperature in °C	Steam intensity	Cooking time in mins
Viennese whirls	Baking tray	1		150 - 160 <sup>1</sup>	-	25 - 40
Viennese whirls	Baking tray	1		140 - 150 <sup>1</sup>	-	25 - 40

<sup>1</sup> Preheat the appliance for five minutes. Do not use the rapid heating function.

<sup>2</sup> Preheat the appliance. Do not use the rapid heating function.

Food	Accessories/cookware	Shelf position	Heating function → Page 7	Temperature in °C	Steam intensity	Cooking time in mins
Viennese whirls, on 2 levels	Universal pan + Baking tray	3+1		140 - 150 <sup>1</sup>	-	30 - 40
Small cakes	Baking tray	1		160 <sup>1</sup>	-	25 - 35
Small cakes	Baking tray	1		150 <sup>1</sup>	-	25 - 35
Small cakes, on 2 levels	Universal pan + Baking tray	3+1		150 <sup>1</sup>	-	25 - 35
Hot water sponge cake	Springform cake tin, diameter 26 cm	1		160 - 170 <sup>2</sup>	-	25 - 35
Hot water sponge cake	Springform cake tin, diameter 26 cm	1		160 - 170 <sup>2</sup>	-	25 - 35
Hot water sponge cake	Springform cake tin, diameter 26 cm	1		<b>1.</b> 150 - 160 <b>2.</b> 150 - 160	Added steam, low -	<b>1.</b> 10 <b>2.</b> 20 - 30

<sup>1</sup> Preheat the appliance for five minutes. Do not use the rapid heating function.

<sup>2</sup> Preheat the appliance. Do not use the rapid heating function.

## Steaming

Slide the universal pan into the cooking compartment one level below the perforated steaming tray (size XL) if instructed to do so in the recommended settings table.

### Shelf positions

Shelf positions when steaming on 1 level:



- Use a maximum of 2.5 kg.

- Perforated steaming tray, size XL: Shelf position 2

Shelf positions when steaming on 2 levels:

- Use a maximum of 1.8 kg per level.
- Perforated steaming tray, size XL: Shelf position 3
- Perforated steaming tray, size XL: Shelf position 2

## Recommended settings for steaming

Food	Accessory/cookware	Shelf position	Heating function → Page 7	Temperature in °C	Cooking time in mins
Peas, frozen, two containers	2 pcs Steam containers, XL size + Universal pan	3+2+1		100	- <sup>1,2</sup>
Broccoli, fresh, 300 g	Steam containers, XL size	2		100 <sup>3</sup>	6-7 <sup>4</sup>
Broccoli, fresh, one container	Steam containers, XL size	2		100 <sup>3</sup>	6-7 <sup>4</sup>

<sup>1</sup> The test is over when 85 °C is reached at the coldest spot (see IEC 60350-1).

<sup>2</sup> The test is over when 85 °C is reached at the coldest spot (see IEC 60350-1).

<sup>3</sup> Preheat the appliance.

<sup>4</sup> A comparable degree of cooking between the reference sample and the main sample is achieved if the reference sample is cooked for 5 minutes (produced as described in IEC 60350-1).

## Recommended settings for grilling

Food	Accessory/cookware	Shelf position	Heating function → Page 7	Temperature in °C	Cooking time in mins
Toasting bread	Wire rack	3		275	2-6

## 26 Installation instructions

Observe this information when installing the appliance.



### **⚠ 26.1 General installation instructions**

Follow these instructions before you start with the installation of the appliance.

- The safe operation of this appliance can only be guaranteed if it has been installed to a professional standard in accordance with these installation instructions. The installer shall be liable for damages incurred as a result of incorrect installation.
- Check the appliance for damage after unpacking it. Do not connect the appliance if it has been damaged in transit.
- Before starting up the appliance, remove any packaging material and adhesive film from the cooking compartment and the door.
- Proceed in accordance with the installation sheets for installing accessories.
- Fitted units must be heat-resistant up to 95 °C, and adjacent unit fronts up to 70 °C.
- Do not install the appliance behind a decorative door or the door of a kitchen unit. There is a risk of overheating.
- Cut-out work on the units should be carried out before installing the appliance. Remove any shavings. Otherwise, the correct operation of electrical components may be adversely affected.
- The mains socket for the appliance must either be located in the hatched area **a** or outside of the area where the appliance is installed.

Any unsecured units must be secured to the wall using a standard bracket **b**.

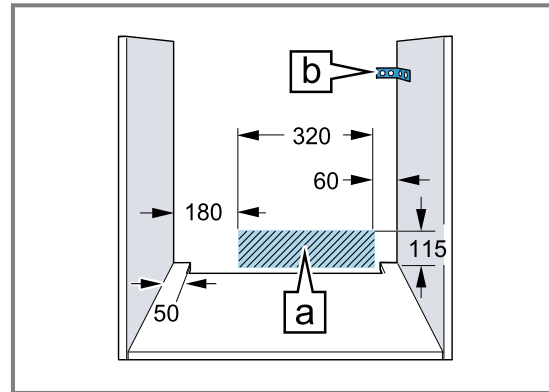

- For appliances that have a hinged switch panel, make sure that the switch panel does not hit adjacent kitchen units when you open it.
- Wear protective gloves so that you do not cut yourself. Parts that are accessible during installation may have sharp edges.
- Dimensions of the figures in mm.

### **⚠ WARNING – Danger: Magnetism!**

Permanent magnets are used in the control panel or in the controls. They may affect electronic implants, e.g. pacemakers or insulin pumps.

- ▶ Wearers of electronic implants must stay at least 10 cm away from the control panel or controls during the installation.

### **⚠ WARNING – Risk of fire!**

It is dangerous to use an extended power cord and non-approved adapters.

- ▶ Do not use multiple socket strips.
- ▶ Only use extension cables that are certified, have a minimum cross section of 1.5 mm<sup>2</sup> and comply with the applicable national safety requirements.
- ▶ If the power cord is too short, contact customer service.
- ▶ Only use adapters approved by the manufacturer.

### **ATTENTION!**

Carrying the appliance by the door handle could break it. The door handle cannot support the weight of the appliance.

- ▶ Do not carry or hold the appliance by the door handle.

## 26.2 Appliance dimensions

You will find the dimensions of the appliance here

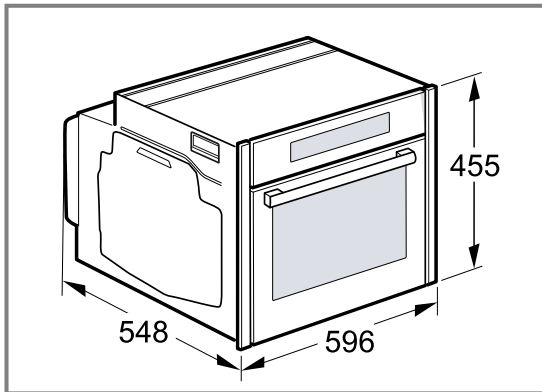

## 26.3 Installation below a worktop

Observe the installation dimensions and the installation instructions when installing below a worktop.

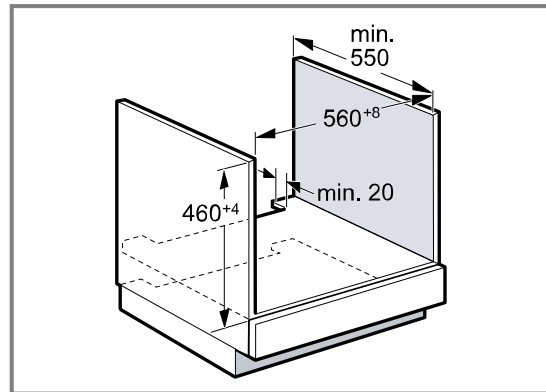

- To ventilate the appliance, the intermediate floor must have a ventilation cut-out.
- The worktop must be secured to the built-in unit.
- Observe any available installation instructions for the hob.

## 26.4 Installation underneath a hob

If the appliance is installed under a hob, the following minimum dimensions must be adhered to (including substructure, if applicable).

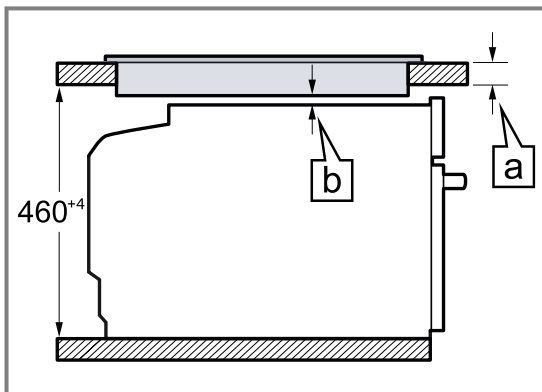

The minimum worktop thickness  $\boxed{b}$  a is based on the required minimum clearance  $\boxed{a}$ .

Hob type	a raised in mm	a flush in mm	b in mm
Induction hob	42	43	5
Full-surface induction hob	52	53	5
Gas hob	32	43	5
Electric hob	32	35	2

## 26.5 Installation in a tall unit

Observe the installation dimensions and the installation instructions when installing in a tall unit.

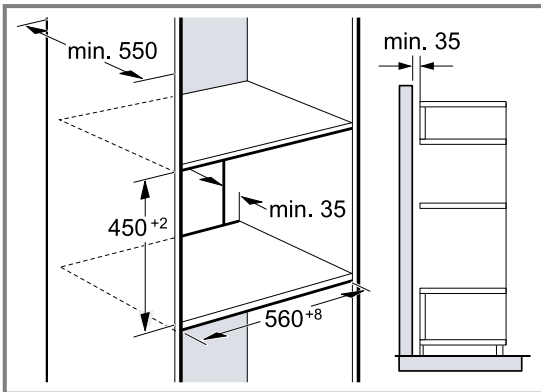

- To ventilate the appliance, the intermediate floors must have a ventilation cut-out.
- If the tall unit has another back panel in addition to the element back panels, this must be removed.
- Only fit the appliance up to a height which allows accessories to be easily removed.

## 26.6 Corner installation

Observe the installation dimensions and the installation instructions when installing in a corner.

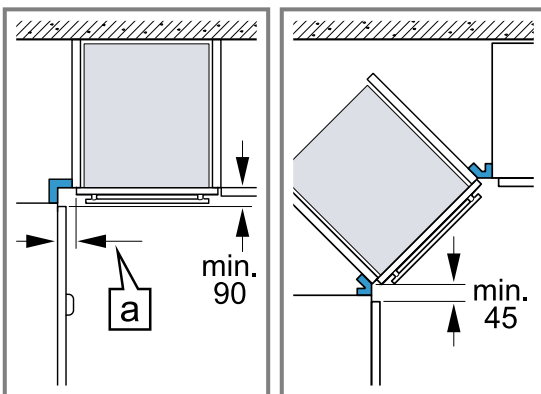

- To ensure that the appliance door can be opened, you must take the minimum dimensions into consideration when installing in a corner. The dimension **a** is dependent on the thickness of the unit front and the handle.

## 26.7 Electrical connection

In order to safely connect the appliance to the electrical system, follow these instructions.

- The appliance corresponds to protection class I and must only be operated with a protective earth connection.
- The fuse protection must correspond to the power rating specified on the appliance's rating plate and to local regulations.
- The appliance must be disconnected from the power supply whenever installation work is being carried out.
- The appliance must only be connected using the power cable provided.

- The power cable must be plugged in at the rear of the appliance until you hear a clicking sound. A 3 m power cable can be obtained from the after-sales service.
- The power cable must only be replaced with a cable from the original manufacturer. This is available from after-sales service.
- Contact protection must be ensured during the installation.

### Electrically connect the appliance with the protective contact plug

**Note:** The appliance must only be connected to a protective contact socket that has been correctly installed.

- ▶ Insert the plug into the protective contact socket. When the appliance is installed, the mains plug of the power cord must be freely accessible. If free access to the mains plug is impossible, an all-pole isolating switch must be integrated into the permanent electrical installation in accordance with the installation regulations.

### Electrically connecting an appliance without a protective contact plug

**Note:** Only a licensed professional may connect the appliance. Damage caused by incorrect connection is not covered under the warranty.

An all-pole isolating switch must be integrated into the permanent electrical installation according to the installation regulations.

1. Identify the phase and neutral conductors in the socket.  
The appliance may be damaged if it is not connected correctly.
2. Connect the hob in accordance with the connection diagram.  
See the rating plate for the voltage.
3. Connect the wires of the mains power cable according to the colour coding:
  - Green/yellow = Protective conductor  $\oplus$
  - Blue = Neutral conductor
  - Brown = Phase (external conductor)

## 26.8 Installing the appliance

**Note:** Do not use a cordless screwdriver to secure the panels. This may damage the panels.

1. Push the appliance in fully.  
Do not kink or trap the connection cable, or route it over sharp edges.

2. Centre the appliance.

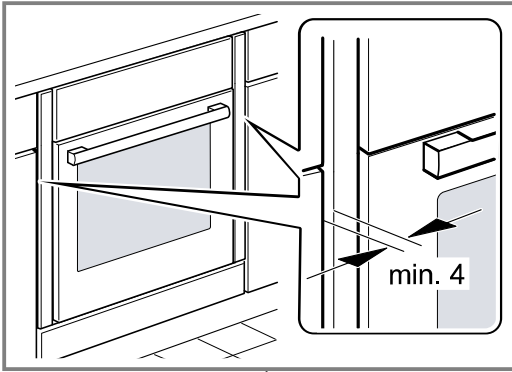

There must be an air gap of at least 4 mm between the appliance and adjacent unit fronts.

3. Open the appliance door and unscrew the left and right-hand panels.

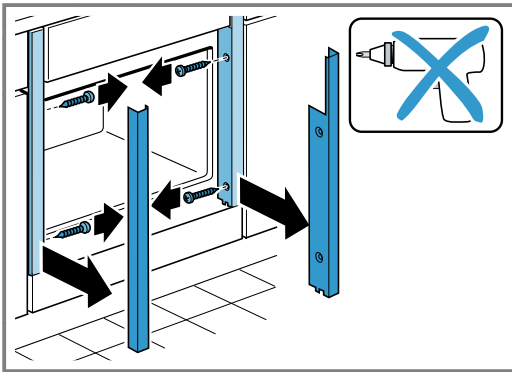

4. Close the appliance door.  
5. Screw the appliance into place.

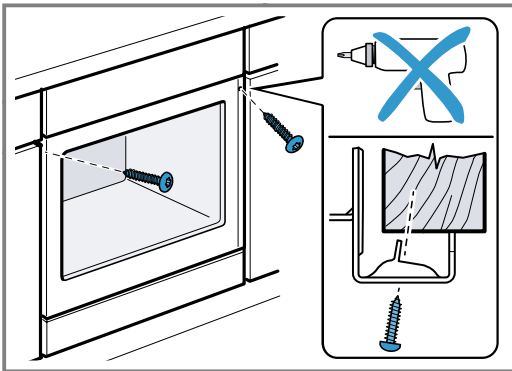

6. For handleless kitchens with vertical bar handle strips:
- Attach a suitable filling piece ① in order to cover any sharp edges and to guarantee a safe installation.
  - Pre-drill aluminium profiles to establish a screw connection ②.
  - Secure the appliance using a suitable screw ③.

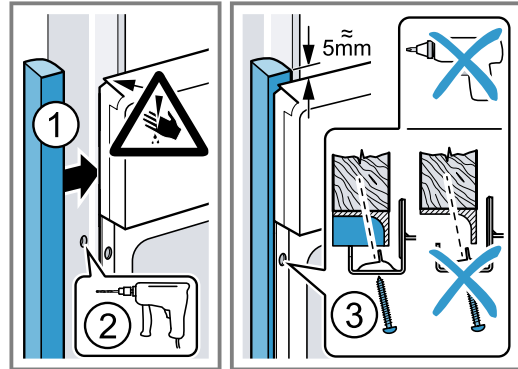

7. Refit the panels and screw them in place, first at the top and then at the bottom.

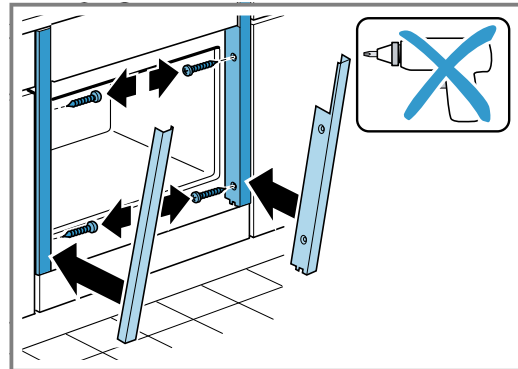

8. If required, the gap between the appliance door and the side panels can be adjusted using the screws at the top left and right.

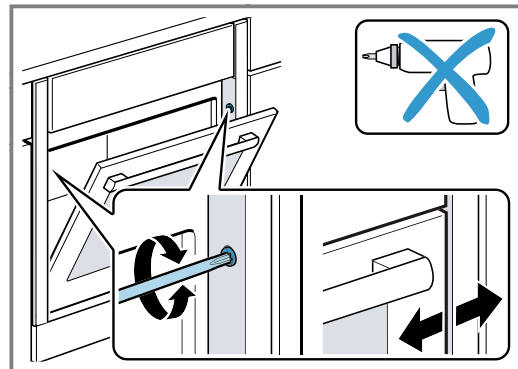

**Note:** The gap between the worktop and the appliance must not be closed by additional battens. Thermal insulation strips must not be fitted to the side panels of the surround unit.

## 26.9 Removing the appliance

1. Disconnect the appliance from the power supply.
2. Open the appliance door and unscrew the left and right-hand panels.
3. Undo the fastening screws.
4. Lift the appliance slightly and pull it out completely.





REGISTER YOUR PRODUCT  
ONLINE [NEFF-HOME.COM](http://NEFF-HOME.COM)

Valid within Great Britain:  
Imported to Great Britain by  
BSH Home Appliances Ltd.  
Grand Union House  
Old Wolverton Road  
Wolverton, Milton Keynes  
MK12 5PT  
United Kingdom



Constructa-Neff Vertriebs-GmbH  
Carl-Wery-Straße 34  
81739 München  
GERMANY

9001613276  
010810  
en