



Oven

[en] User manual and installation instructions

B17CR32N1B



Further information and explanations are available online:



Table of contents

INFORMATION FOR USE

1	Safety	2
2	Preventing material damage	4
3	Environmental protection and saving energy	5
4	Familiarising yourself with your appliance	6
5	Accessories	8
6	Before using for the first time	10
7	Basic operation	10
8	Time-setting options	11
9	Childproof lock	12
10	Rapid heat-up	13
11	Sabbath mode	14
12	Basic settings	14
13	Cleaning and servicing	15
14	Cleaning functions	17
15	Rails	18
16	Appliance door	19
17	Troubleshooting	22
18	Disposal	24
19	Customer Service	24
20	How it works	25
21	INSTALLATION INSTRUCTIONS	30
21.1	General installation instructions	30

- Keep the instruction manual and the product information safe for future reference or for the next owner.
- Do not connect the appliance if it has been damaged in transit.

1.2 Intended use

This appliance is designed only to be built into kitchen units. Read the special installation instructions.

Only a licensed professional may connect appliances without plugs. Damage caused by incorrect connection is not covered under the warranty.

Only use this appliance:

- To prepare meals and drinks.
- In private households and in enclosed spaces in a domestic environment.
- Up to an altitude of max. 4000 m above sea level.

1.3 Restriction on user group

This appliance may be used by children aged 8 or over and by people who have reduced physical, sensory or mental abilities or inadequate experience and/or knowledge, provided that they are supervised or have been instructed on how to use the appliance safely and have understood the resulting dangers.

Do not let children play with the appliance.

Children must not perform cleaning or user maintenance unless they are at least 15 years old and are being supervised.

Keep children under the age of 8 years away from the appliance and power cable.

1 Safety

Observe the following safety instructions.

1.1 General information

- Read this instruction manual carefully.

1.4 Safe use

Always place accessories in the cooking compartment the right way round.

→ "Accessories", Page 8

⚠ WARNING – Risk of fire!

Combustible objects that are left in the cooking compartment may catch fire.

- ▶ Never store combustible objects in the cooking compartment.
- ▶ If smoke is emitted, the appliance must be switched off or the plug must be pulled out and the door must be held closed in order to stifle any flames.

Loose food remnants, fat and meat juices may catch fire.

- ▶ Before using the appliance, remove the worst of the food residues and remnants from the cooking compartment, heating elements and accessories.

Opening the appliance door creates a draught. Greaseproof paper may come into contact with the heating element and catch fire.

- ▶ Never place greaseproof paper loosely over accessories when preheating the appliance and while cooking.
- ▶ Always cut greaseproof paper to size and use a plate or baking tin to hold it down.

⚠ WARNING – Risk of burns!

The appliance and its parts that can be touched become hot during use.

- ▶ Caution should be exercised here in order to avoid touching heating elements.
- ▶ Young children under 8 years of age must be kept away from the appliance.

Accessories and cookware get very hot.

- ▶ Always use oven gloves to remove accessories or cookware from the cooking compartment.

When the cooking compartment is hot, any alcoholic vapours inside may catch fire. The appliance door may spring open. Hot steam and jets of flame may escape.

- ▶ Only use small quantities of drinks with a high alcohol content in food.
- ▶ Do not heat spirits ($\geq 15\%$ vol.) when undiluted (e.g. for marinating or pouring over food).
- ▶ Open the appliance door carefully.

⚠ WARNING – Risk of scalding!

The accessible parts of the appliance become hot during operation.

- ▶ Never touch these hot parts.
- ▶ Keep children at a safe distance.

Hot steam may escape when you open the appliance door. Steam may not be visible, depending on the temperature.

- ▶ Open the appliance door carefully.
- ▶ Keep children at a safe distance.

If there is water in the cooking compartment when it is hot, this may create hot steam.

- ▶ Never pour water into the cooking compartment when the cooking compartment is hot.

⚠ WARNING – Risk of injury!

Scratched glass in the appliance door may develop into a crack.

- ▶ Do not use any harsh or abrasive cleaners or sharp metal scrapers to clean the glass on the oven door, as they may scratch the surface.

The appliance and its parts that can be touched may have sharp edges.

- ▶ Take care when handling and cleaning them.
- ▶ If possible, wear protective gloves.

The hinges on the appliance door move when the door is opened and closed, which could trap your fingers.

- ▶ Keep your hands away from the hinges. Components inside the appliance door may have sharp edges.
- ▶ Wear protective gloves.

Alcoholic vapours may catch fire in the hot cooking compartment, and the appliance door may spring open and may fall off. The door panels may shatter and fragment.

→ "Preventing material damage", Page 4

- ▶ Only use small quantities of drinks with a high alcohol content in food.
- ▶ Do not heat spirits ($\geq 15\%$ vol.) when undiluted (e.g. for marinating or pouring over food).
- ▶ Open the appliance door carefully.

⚠ WARNING – Risk of electric shock!

Incorrect repairs are dangerous.

- ▶ Repairs to the appliance should only be carried out by trained specialist staff.
- ▶ Only use genuine spare parts when repairing the appliance.
- ▶ If the power cord of this appliance is damaged, it must be replaced by trained specialist staff.

If the insulation of the power cord is damaged, this is dangerous.

- ▶ Never let the power cord come into contact with hot appliance parts or heat sources.
- ▶ Never let the power cord come into contact with sharp points or edges.
- ▶ Never kink, crush or modify the power cord.

An ingress of moisture can cause an electric shock.

- ▶ Do not use steam- or high-pressure cleaners to clean the appliance.

If the appliance or the power cord is damaged, this is dangerous.

- ▶ Never operate a damaged appliance.
- ▶ Never pull on the power cord to unplug the appliance. Always unplug the appliance at the mains.
- ▶ If the appliance or the power cord is damaged, immediately unplug the power cord or switch off the fuse in the fuse box.
- ▶ Call customer services. → *Page 24*

⚠ WARNING – Danger: Magnetism!

Permanent magnets are used in the control panel or in the controls. These may affect electronic implants, e.g. heart pacemakers or insulin pumps.

- ▶ Wearers of electronic implants must stay at least 10 cm away from the control panel.

⚠ WARNING – Risk of suffocation!

Children may put packaging material over their heads or wrap themselves up in it and suffocate.

- ▶ Keep packaging material away from children.
- ▶ Do not let children play with packaging material.

Children may breathe in or swallow small parts, causing them to suffocate.

- ▶ Keep small parts away from children.
- ▶ Do not let children play with small parts.

1.5 Halogen bulb

⚠ WARNING – Risk of burns!

The bulbs in the cooking compartment get very hot. There is still a risk of burning for some time after they have been switched off.

- ▶ Do not touch the glass cover.
- ▶ Avoid contact with your skin when cleaning.

⚠ WARNING – Risk of electric shock!

When changing the bulb, the bulb socket contacts are live.

- ▶ Before replacing the bulb, ensure that the appliance is switched off in order to prevent a potential electric shock.
- ▶ Also unplug the appliance from the mains or switch off the circuit breaker in the fuse box.

1.6 Cleaning function

⚠ WARNING – Risk of burns!

The outside of the appliance gets very hot when the cleaning function is in progress.

- ▶ Never touch the appliance door.
- ▶ Allow the appliance to cool down.
- ▶ Keep children at a safe distance.

2 Preventing material damage

2.1 General

ATTENTION!

Alcoholic vapours may catch fire in the hot cooking compartment and cause permanent damage to the appliance. The appliance door may spring open due to an explosion and it may fall off. The door panels may shatter and fragment. Due to the resulting negative pressure, the cooking compartment may become considerably deformed inwards.

- ▶ Do not heat spirits ($\geq 15\%$ vol.) when undiluted (e.g. for marinating or pouring over food).

If there is water on the cooking compartment floor when operating the appliance at temperatures above 120 °C, this will damage the enamel.

- ▶ Do not use the appliance if there is water on the cooking compartment floor.
- ▶ Wipe away any water on the cooking compartment floor before operation.

Objects on the cooking compartment floor at over 50 °C will cause heat to build up. The baking and roasting times will no longer be correct and the enamel will be damaged.

- ▶ Do not place any accessories, greaseproof paper or foil of any kind on the cooking compartment floor.
 - ▶ Only place cookware on the cooking compartment floor if a temperature above 50 °C has been set.
- When the cooking compartment is hot, any water inside it will create steam. The change in temperature may cause damage.
- ▶ Never pour water into the cooking compartment when it is still hot.
 - ▶ Never place cookware containing water on the cooking compartment floor.

The prolonged presence of moisture in the cooking compartment leads to corrosion.

- ▶ Allow the cooking compartment to dry after use.
- ▶ Do not keep moist food in the cooking compartment for a long time with the door closed.
- ▶ Do not store food in the cooking compartment.

Leaving the appliance to cool down with the door open will damage the front of neighbouring kitchen units over time.

- ▶ Always allow the cooking compartment to cool down with the door closed after cooking at high temperatures.
- ▶ Take care not to trap anything in the appliance door.
- ▶ Only leave the cooking compartment to dry with the door open if a lot of moisture was produced during operation.

Fruit juice dripping from the baking tray leaves stains that cannot be removed.

- ▶ When baking very juicy fruit flans, do not pack too much on the baking tray.
- ▶ If possible, use the deeper universal pan.

Using oven cleaner in a hot cooking compartment damages the enamel.

- ▶ Never use oven cleaner in the cooking compartment when it is still warm.
- ▶ Remove all food remnants from the cooking compartment and the appliance door before you next heat up the appliance.

If the seal is very dirty, the appliance door will no longer close properly during operation. This may damage the front of adjacent kitchen units.

- ▶ Keep the seal clean at all times.
- ▶ Never operate the appliance if the seal is damaged or missing.

Sitting or placing objects on the appliance door may damage it.

- ▶ Do not place, hang or support objects on the appliance door.
- ▶ Do not place cookware or accessories on the appliance door.

With certain models, accessories may scratch the door pane when closing the appliance door.

- ▶ Always push accessories fully into the cooking compartment.

3 Environmental protection and saving energy

3.1 Disposing of packaging

The packaging materials are environmentally compatible and can be recycled.

- ▶ Sort the individual components by type and dispose of them separately.

3.2 Saving energy

If you follow these instructions, your appliance will use less power.

Only preheat the appliance if the recipe or the recommended settings tell you to do so.

- Not preheating the appliance can reduce the energy used by up to 20%.

Use dark-coloured, black-coated or enamelled baking tins.

- These types of baking tin absorb the heat particularly well.

Open the appliance door as little as possible during operation.

- This maintains the temperature in the cooking compartment and eliminates the need for the appliance to reheat.

When baking multiple dishes, do so in succession or in parallel.

- The cooking compartment is heated after baking the first dish. This reduces the baking time for the second cake.

If the cooking time is relatively long, you can switch the appliance off 10 minutes before the cooking time ends.

- There will be enough residual heat to finish cooking the dish.

Remove any accessories that are not being used from the cooking compartment.

- Accessories that are not being used do not need to be heated.

Allow frozen food to defrost before cooking.

- This saves the energy that would otherwise be required to defrost it.

Note:

The appliance requires:

- A maximum of 1 W when the appliance is in operation with the display switched on
- A maximum of 0.5 W when the appliance is in operation with the display switched off

4 Familiarising yourself with your appliance

4.1 Control panel

You can use the control panel to configure all functions of your appliance and to obtain information about the operating status.

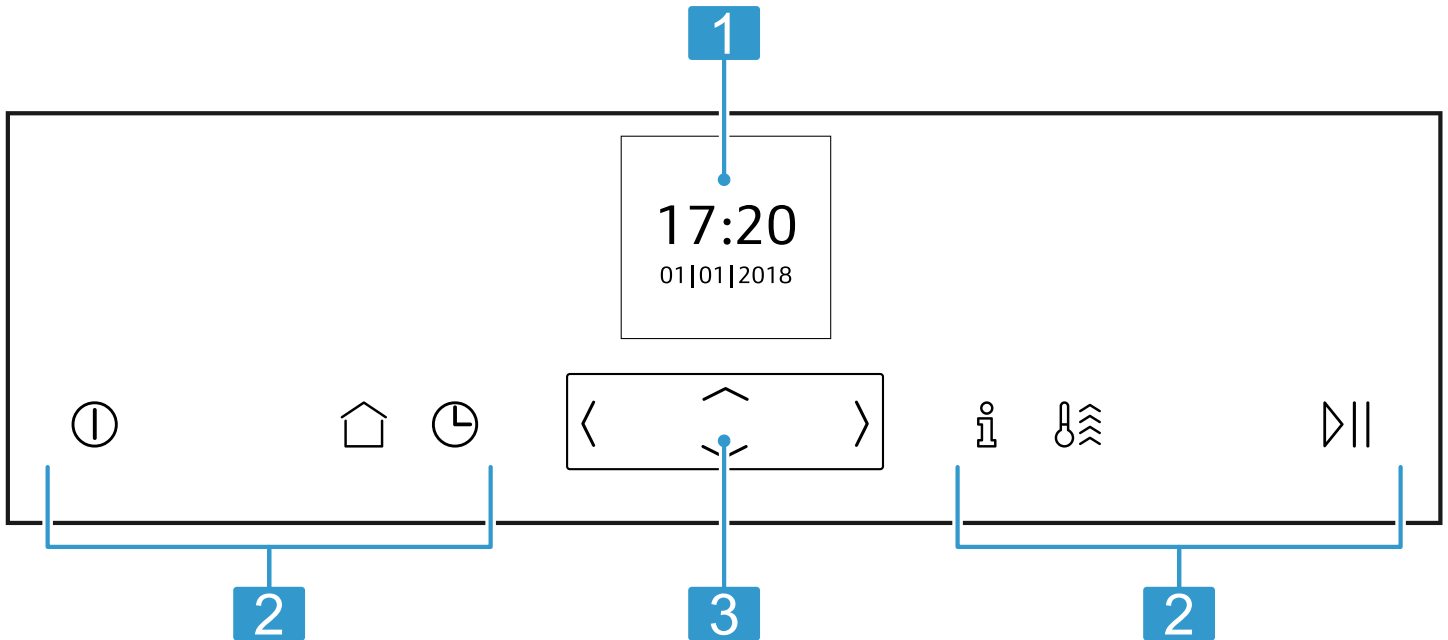

1 Display

2 Buttons

3 Control element

4.2 Buttons

The buttons are touch-sensitive areas. To select a function, press the corresponding button.



Symbol	Name	Use
ⓘ	On/off	Switch the appliance on or off
🏠	Main menu	Select operating modes and settings
🕒	Time-setting options/ childproof lock	<ul style="list-style-type: none"> Set the "timer", "cooking time" or "Ready at" time for delayed starts Activate or deactivate the "childproof lock"
ℹ️	Information	<ul style="list-style-type: none"> View additional information View the current temperature
🔥	Rapid heat-up	<ul style="list-style-type: none"> Activate or deactivate the "Rapid heat-up" function Activate or deactivate the "PowerBoost" function
▶	Start/stop	Start or pause the appliance

4.3 Control element

You can configure all the functions on your appliance using the control element. You can change the setting values that are displayed more brightly.

Press and hold a button to scroll through the setting values quickly. Release the button to stop scrolling quickly.

Button	Name	Use
<	Left	Navigate to the left on the display

Button	Name	Use
	Right	Navigate to the right on the display
	Up	Navigate upwards on the display
	Down	Navigate downwards on the display





4.4 Display

The display shows the current settings, options or relevant information.

4.5 Main menu

The main menu provides an overview of your appliance's functions.











Press the  button to open the main menu.



Function	Name	Use
	Heating functions	Select the required heating function and temperature for your food
	Settings	Individually adjust the appliance settings
	EasyClean	Clean less stubborn dirt from the cooking compartment
	EcoClean	Clean the cooking compartment

4.6 Types of heating

This is where you will find an overview of the types of heating. You will find recommendations for using the types of heating.

For temperatures above 275 °C, the appliance reduces the temperature to approx. 275 °C after around 40 minutes.

Symbol	Heating function	Temperature	Use
	CircoTherm® hot air	40 - 200 °C	Bake or roast on one or more levels. The fan distributes the heat from the ring-shaped heating element in the back wall evenly around the cooking compartment.
	Top/bottom heating	50 - 275 °C	Traditionally bake or roast on one level. This type of heating is especially good for cakes with moist toppings. The heat is emitted evenly from above and below.
	Circo-roasting	50 - 250 °C	Roast poultry, whole fish or larger pieces of meat. The grill element and the fan switch on and off alternately. The fan circulates the hot air around the food.
	Pizza setting	50 - 275 °C	Cook pizza or food that requires a lot of heat from below. The bottom heating element and the ring-shaped heating element in the back wall heat the cooking compartment.
	Bread-baking setting	180 - 240 °C	For baking bread, bread rolls and baked goods that require high temperatures.
	Full-surface grill	50 - 290 °C	For grilling flat items such as steaks, sausages or bread, and for cooking au gratin. The entire area below the grill element becomes hot.
	Centre-area grill	50 - 290 °C	For grilling small amounts of steaks, sausages or bread, and for cooking au gratin. The central area below the grill element becomes hot.
	Bottom heating	30 - 250 °C	For cooking in a bain marie and for baking food for extra time. The heat is emitted from below.
	Slow cooking	70 - 120 °C	For gentle, slow cooking of seared, tender pieces of meat in cookware without a lid. The heat is emitted evenly from above and below at a low temperature.
	Dough proving	35 - 55 °C	For proving dough and culturing yoghurt. Dough will prove more quickly than at room temperature. The surface of the dough does not dry out.

Symbol	Heating function	Temperature	Use
	Top/bottom heating eco	50 - 275 °C	For gently cooking selected types of food. Heat is emitted from above and below. This type of heating is most effective between 150 and 250 °C. This type of heating is used to determine the energy consumption in the conventional mode.
	CircoTherm® eco	40 - 200 °C	For gently cooking selected types of food on one level without preheating. The fan distributes the heat from the ring-shaped heating element in the back wall around the cooking compartment. This type of heating is most effective between 125 and 200 °C. This type of heating is used to determine the energy consumption in circulating-air mode and the energy efficiency class.

4.7 Cooking compartment

The functions in the cooking compartment make your appliance easier to use.

Shelf supports

The rails in the cooking compartment enable you to place accessories at different heights.

→ "Accessories", Page 8

Your appliance has four shelf positions. The shelf positions are numbered from bottom to top.

You can remove the rails, e.g. for cleaning.

→ "Rails", Page 18

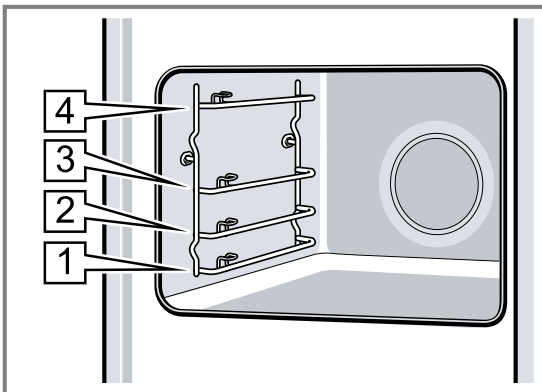

Self-cleaning surfaces

The self-cleaning surfaces in the cooking compartment are coated with a porous, matt ceramic layer and have a rough surface. When the appliance is in operation, the self-cleaning surfaces absorb splashes from roasting or grilling and break them down.

The following surfaces are self-cleaning:

- Back wall

- Ceiling
- Side walls

Use the cleaning function regularly to help retain the cleaning ability of the self-cleaning surfaces and prevent damage.

→ "EcoClean cleaning function", Page 17

Lighting

One or more oven lights illuminate the cooking compartment.

When you open the appliance door, the light in the cooking compartment switches on. If the appliance door remains open for longer than 15 minutes, the light switches off again.

For most operating modes, the lighting is switched on during operation. The lighting switches off again when the operation ends.

Cooling fan

The cooling fan switches on and off depending on the appliance's temperature. The hot air escapes above the door.

ATTENTION!

Do not cover the ventilation slot above the appliance door. The appliance overheats.

- ▶ Ensure that the ventilation slots are unobstructed.

To ensure that the appliance cools down more quickly after operation, the cooling fan continues to run for a certain period afterwards.

Appliance door

If you open the appliance door during operation, the operation stops. When you close the appliance door, the operation continues automatically.

5 Accessories

Use original accessories. These have been made especially for your appliance.

Note: Accessories may become deformed if they get hot. Deformation has no effect on function. As the accessory cools down, it will regain its original shape.

The accessories supplied may differ depending on the appliance model.

Accessories	Use
Wire rack	<ul style="list-style-type: none"> ■ Cake tins ■ Ovenproof dishes ■ Cookware ■ Meat, e.g. roasting joints or steak ■ Frozen meals
Universal pan	<ul style="list-style-type: none"> ■ Moist cakes ■ Baked items ■ Bread ■ Large roasts ■ Frozen meals ■ Catch dripping liquids, e.g. fat when grilling food on the wire rack.

5.1 Locking function

The locking function prevents the accessories from tilting when they are pulled out.

You can pull out the accessories approximately halfway without them tipping. The accessories must be inserted into the cooking compartment correctly for the tilt protection to work properly.

5.2 Sliding accessories into the cooking compartment

Always slide the accessory into the cooking compartment the right way round. This is the only way to ensure that accessories can be pulled out approximately halfway without tipping.

1. Turn the accessories so that the notch **a** is at the rear and is facing downwards.
2. Insert the accessory between the two guide rods for a shelf position.

3. Push the accessory all the way in, making sure that it does not touch the appliance door.

Note: Take any accessories that you will not be using out of the cooking compartment while the appliance is in operation.

Combining accessories

You can combine the wire rack with the universal pan to catch any liquid that drips down.

1. Place the wire rack on the universal pan so that both spacers **a** are on the rear edge of the universal pan.
2. Insert the universal pan between the two guide rods for a shelf position. In so doing, the wire rack is on top of the upper guide rod.

Wire rack on universal pan

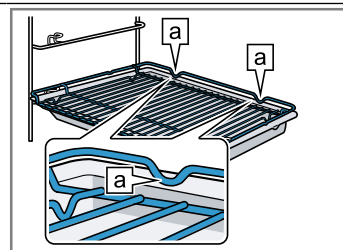

5.3 Other accessories

You can purchase other accessories from our after-sales service, specialist retailers or online.

You will find a comprehensive range of products for your appliance in our brochures and online: www.neff-international.com

Accessories vary from one appliance to another. When purchasing accessories, always quote the exact product number (E no.) of your appliance.

You can find out which accessories are available for your appliance in our online shop or from our after-sales service.

Wire rack Insert the wire rack with the open side facing the appliance door and the curved lip **a** facing downwards.

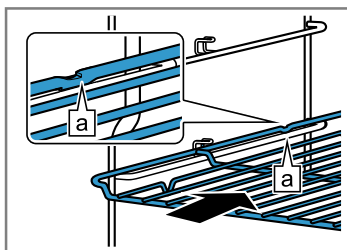

Baking tray E.g. universal pan or baking tray Slide the tray in with the sloping edge **b** towards the appliance door.

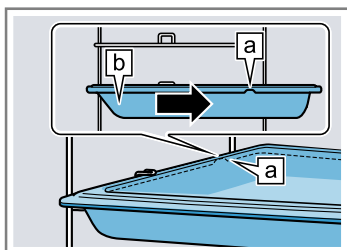

6 Before using for the first time

Configure the settings for initial start-up. Clean the appliance and accessories.

6.1 Initial use

When the appliance is connected to the power supply for the first time or following a lengthy power failure, the settings that you will need to configure before you can use it will appear.

Note: You can change these settings at any time by going to the basic settings.

→ "Basic settings", Page 14

Setting the language

1. Connect the appliance to the power supply.
 - ✓ The first setting will appear after a few seconds.
2. Use the \sim button to navigate to the bottom row.
3. Use the \langle or \rangle button to select the language.
4. Use the \wedge button to navigate back to the top row.
5. Use the \rangle button to select the next setting.

Setting the time

1. Use the \sim button to navigate to the next row.
2. Use the \langle or \rangle button to select the current time.
3. Use the \wedge button to navigate back to the top row.
4. Use the \rangle button to select the next setting.

Setting the date

1. Use the \sim button to navigate to the next row.
2. Use the \langle or \rangle button to select the correct day.
3. Use the \wedge button to navigate back to the top row.
4. Use the \rangle button to select the next setting.
5. Use the \sim button to navigate to the next row.
6. Use the \langle or \rangle button to select the correct month.
7. Use the \wedge button to navigate back to the top row.
8. Use the \rangle button to select the next setting.
9. Use the \sim button to navigate to the next row.
10. Use the \langle or \rangle button to select the correct year.

11. Use the \wedge button to navigate back to the top row.
12. Open and close the appliance door once.
 - ✓ The appliance will perform a self-test, after which it will be ready to use.
 - ✓ Initial configuration is now complete.

6.2 Cleaning the appliance

Before using the appliance to cook food for the first time, you must clean the cooking compartment and accessories.

1. Remove the product information, accessories and any leftover packaging (e.g. polystyrene pellets) from the cooking compartment.
2. Wipe the smooth surfaces in the cooking compartment with a soft, damp cloth.
3. Press \odot to switch the appliance on.
 - "Switching on the appliance", Page 10
4. Set the required heating function and temperature for the heat-up process and press \gg to start.
 - "Setting the type of heating and temperature", Page 10

Heating up

Heating function	CircoTherm hot air \mathcal{A}
Temperature	Maximum
Cooking time	1 hour

5. Keep the kitchen ventilated while the appliance is heating.
6. Press \odot to switch off the appliance after 1 hour.
 - "Switching off the appliance", Page 10
7. Allow the appliance to cool down.
8. Clean the smooth surfaces with soapy water and a dish cloth.
9. Thoroughly clean any accessories you used with soapy water and a dish cloth.

7 Basic operation

7.1 Switching on the appliance

- ▶ Press \odot to switch the appliance on.

Notes

- In the basic settings, you can specify whether the heating functions or the main menu should appear when you switch on the appliance.
 - "Basic settings", Page 14
- If you do not perform any actions on the appliance for an extended period, it will automatically switch itself off.

7.2 Switching off the appliance

- ▶ Press \odot to switch the appliance off.

Notes

- The residual heat indicator will appear on the display while the cooking compartment is still hot.
 - "Residual heat indicator", Page 10

- The cooling fan will continue to run until the cooking compartment has cooled down.
 - "Cooling fan", Page 8

7.3 Residual heat indicator

After you have switched off the appliance, the residual heat indicator will appear on the display.

Display	Meaning
-H-	Residual heat high (over 120 °C)
-h-	Residual heat low (between 60 and 120 °C)

7.4 Setting the type of heating and temperature

1. Press \odot to switch the appliance on.
 - ✓ The heating functions will then be displayed.

2. Use the < or > button to select the required heating function.
3. Use the ~ button to navigate to the next row.
4. Use the < or > button to select the required temperature or setting.
5. Press ▶|| to start.
 - ✓ The cooking time will appear on the display.
 - ✓ The heat-up indicator bar visualises the rising temperature.
6. When the food is ready, press ⏻ to switch the appliance off.

7.5 Changing the temperature

You can also change the temperature once you have started the appliance.

1. Use the ^ or ~ button to select the temperature row.
2. Use the < or > button to select the required temperature.
- ✓ The temperature will now be changed.

7.6 Changing the type of heating

If you switch to a different heating function, the appliance will reset all the settings.

1. Press ▶|| to pause operation.
2. Use the < or > button to select the required heating function.
3. Use the ~ button to navigate to the next row.
4. Use the < or > button to select the required temperature.

5. Press ▶|| to start.

7.7 Pausing operation

1. Press ▶||.
2. Press ▶|| again to resume operation.

7.8 Cancelling operation

Note: Some functions, e.g. cleaning functions, cannot be cancelled.

- ▶ Press and hold the ▶|| button until the function that is currently in progress is cancelled.
- ✓ Operation will stop and all the settings will be reset.
- ✓ The cooling fan will continue to run until the cooking compartment has cooled down.

7.9 Viewing the current temperature

You can view the current temperature while the appliance is heating up.

- ▶ Press ⓘ.
- ✓ The temperature will be displayed for a few seconds.

7.10 Displaying information

Requirement: The ⓘ button must be lit.

- ▶ Press ⓘ.
- ✓ The information will be displayed for a few seconds.

8 Time-setting options

Your appliance has different time-setting options, with which you can control its operation.

8.1 Overview of the time-setting options

When you are setting a time, the time values will increase by greater increments as you scroll through the higher values. The cooking time, for example, can be set in 1-minute increments up to 1 hour, and then in 5-minute increments thereafter.

Time-setting option	Use
Timer ⏻	When you set a time on the timer, the timer will run independently of the appliance and will not intervene in its operation. The timer does not affect the appliance.
Cooking time →	Once the cooking time has elapsed, the appliance automatically stops heating.
Ready at →	Along with the cooking time (duration), you can set the time at which you want cooking to end. The appliance will start up automatically so that it finishes cooking at the required time.

8.2 Timer

You can set the timer regardless of whether the appliance is on or off.

Setting the timer

1. Press ⏻.
2. Once the appliance is switched on, use the ^ button to select "Timer" ⏻.
3. Use the < or > button to select the timer duration.
4. Press ⏻ to start the timer.
 - ✓ ⏻ will appear on the display. The timer duration will then count down.
 - ✓ Once the timer duration has elapsed, an audible signal will sound.
5. Press any button to end the audible signal.

Changing the timer

1. Press ⏻.
2. Use the < or > button to change the timer duration.
- ✓ The setting will then be applied.

Cancelling the timer

1. Press ⏻.
2. Use the < button to set a timer duration of "00:00".
 - ✓ This cancels the current timer duration.

8.3 Cooking time

Once the set cooking time has elapsed, the appliance switches off automatically. You can only use the cooking time in conjunction with a heating function.

Setting the cooking time

1. Set a heating function and a temperature.
2. Press .
3. Select the default value.



Button	Default value
<	10 minutes
>	30 minutes

4. Use the < or > button to select the required cooking time.
5. Once the cooking time has been set, press  to start.
 - ✓ The cooking time will appear on the display. The cooking time will count down.
 - ✓ Once the cooking time has elapsed, an audible signal will sound.
6. Press any button to end the audible signal.

Changing the cooking time

1. Press .
2. Use the < or > button to change the cooking time.
 - ✓ The setting will then be applied.

Cancelling the cooking time

1. Press .
2. Use the < button to set a cooking time of "00:00".
 - ✓ This cancels the current cooking time.
3. To continue without setting a cooking time, press .

8.4 Delayed start/"Ready at" time



With this function, the appliance automatically switches itself on, and then switches itself off at the preselected end time. To enable it to do this, you set the cooking

time (duration) and specify when you want your food to be ready. You can only use the delayed start function in conjunction with a heating function.



Setting the "Ready at" time for delayed starts

Notes

- Do not leave food that spoils easily in the cooking compartment for too long.
- You cannot use the delayed start function with every heating function.

1. Place the food into the cooking compartment and close the appliance door.
2. Set a heating function and a temperature.
3. Press .
4. Use the < or > button to select the required cooking time.
5. Use the  button to navigate to "Ready at" →|.
 - ✓ The time at which your food will be ready will appear on the display.
6. Use the > button to select the required end time.
7. Press  to confirm the delayed start.
 - ✓ The appliance will start at the appropriate time.
 - ✓ Once the cooking time has elapsed, an audible signal will sound.
8. Press any button to end the audible signal.

Changing the "Ready at" time for delayed starts

1. Press .
2. Use the  button to select "Ready at" →|.
3. Use the < or > button to change the end time.
 - ✓ The setting will then be applied.

Cancelling the "Ready at" time for delayed starts



1. Press .
2. Use the < button to reset the end time.
 - ✓ The end time corresponds to the current time plus the set cooking time.
 - ✓ The appliance will start heating using the set cooking time.

9 Childproof lock

You can secure your appliance to prevent children from accidentally switching it on or changing the settings.

9.1 Locks



Your appliance has two different locks:

Lock	Activate/deactivate
Automatic childproof lock	Via the Settings menu 
One-time childproof lock	Using the  button







9.2 Activating the automatic childproof lock

The automatic childproof lock disables the control panel to prevent children from accidentally switching on the appliance. To switch on the appliance, interrupt

the automatic childproof lock. Once the appliance has finished cooking, it automatically disables the control panel.

Note: When you activate the automatic childproof lock, the appliance will immediately disable the control panel. The  and  buttons will not be disabled.

Requirement: The appliance must be switched on.

1. Press .
2. Use the < or > button to select "Settings" .
3. Use the  button to navigate to the next row.
4. Use the < or > button to select "Automatic childproof lock".
5. Use the  button to select the required settings.
6. Use the > button to set the lock to "Activated".
7. Press .
8. Use the  button to save your settings.
 - ✓ When you switch off the appliance,  will appear on the display.

9.3 Interrupting the automatic childproof lock

1. Press and hold the \ominus button until "Childproof lock deactivated" appears on the display.
2. Press \odot to switch the appliance on and then start it up.

9.4 Deactivating the automatic childproof lock

1. Press and hold the \ominus button until "Childproof lock deactivated" appears on the display.
2. Press \odot to switch the appliance on.
3. Press \square .
4. Use the \langle or \rangle button to select "Settings" \otimes .
5. Use the \sim button to navigate to the next row.
6. Use the \langle or \rangle button to select "Automatic childproof lock".
7. Use the \sim button to select the required settings.
8. Use the \langle button to set the lock to "Deactivated".
9. Press \square .

10. Use the \sim button to save your settings.

9.5 Activating the one-time childproof lock

The one-time childproof lock disables the control panel to prevent children from accidentally switching on the appliance. To switch on the appliance, deactivate the one-time childproof lock. After you have switched off the appliance, the control panel will no longer be disabled.

Note: When you activate the automatic childproof lock, the appliance will immediately disable the control panel. The \ominus and \odot buttons will not be disabled.

- ▶ Press and hold the \ominus button until "Childproof lock activated" appears on the display.

9.6 Deactivating the one-time childproof lock

- ▶ Press and hold the \ominus button until "Childproof lock deactivated" appears on the display.

10 Rapid heat-up

You can use the "Rapid heat-up" and "PowerBoost" functions to reduce the heat-up time. Whether the appliance is preheated with the "Rapid heat-up" function or the "PowerBoost" function depends on the heating function that has been set.

10.1 Rapid heat-up and PowerBoost

Function	Heating function	Food in the cooking compartment
Rapid heat-up	Top/bottom heating \equiv	After preheating
PowerBoost	<ul style="list-style-type: none"> ▪ CircoTherm hot air \wp ▪ Bread-baking setting $\underline{\text{m}}$ 	Before heating up Only cook on one level

10.2 Activating the "Rapid heat-up" function

1. Set Top/bottom heating \equiv and a temperature of at least 100 °C.
2. Press $\triangleright||$ to start.
 - ✓ The \wp button will be lit.
3. Use the \wp button to activate the "Rapid heat-up" function.
 - ✓ \wp will appear on the display.
 - ✓ Once the set temperature has been reached, the "Rapid heat-up" function will switch itself off automatically and an audible signal will sound. \wp will go out on the display.
4. Place the food in the cooking compartment.

10.3 Deactivating the "Rapid heat-up" function

- ▶ Use the \wp button to deactivate the "Rapid heat-up" function early.

10.4 Activating the "PowerBoost" function

1. Place the food on a single level in the cooking compartment.
2. Set CircoTherm hot air \wp or the Bread-baking setting $\underline{\text{m}}$ and a temperature of at least 100 °C.
3. Press $\triangleright||$ to start.
 - ✓ The \wp button will be lit.
4. Press the \wp button to activate the "PowerBoost" function.
 - ✓ \wp will appear on the display.
 - ✓ Once the set temperature has been reached, the "PowerBoost" function will switch itself off automatically and an audible signal will sound. \wp will go out on the display.

10.5 Deactivating the "PowerBoost" function

- ▶ Use the \wp button to deactivate the "PowerBoost" function early.

11 Sabbath mode

You can set a cooking time of up to 74 hours using Sabbath mode. You can use top/bottom heating to keep food warm between 85 °C and 140 °C during this time without having to switch the appliance on or off.



11.1 Starting Sabbath mode









Notes

- If you open the appliance door during operation, the appliance stops heating. When you close the appliance door, the appliance continues to heat again.
- Once you have started the operation, you cannot change any settings or pause operation.

Requirement: Sabbath mode must be activated in "Favourites" in the basic settings.

→ "Basic settings", Page 14

1. Press  to switch the appliance on.
2. Use  or  to select "Sabbath mode".

3. Use  to navigate to the next row.
4. Use  or  to select the temperature.
5. Use  to navigate to the next row.
6. Use  or  to select the cooking time.
7. Press  to start Sabbath mode.
- ✓ The cooking time appears on the display. The cooking time counts down.
8. Once the cooking time has elapsed, an audible signal sounds. A note appears on the display confirming that the operation has finished. The appliance stops heating up and responds again as usual outside of Sabbath mode.
 - Press  to switch the appliance off. The appliance automatically switches off after approx. 10 to 20 minutes.

11.2 Cancelling Sabbath mode

- ▶ Press  to cancel Sabbath mode.

12 Basic settings

You can configure the appliance to meet your needs.

12.1 Overview of the basic settings

Here you can find an overview of the basic settings and factory settings. The basic settings depend on the features of your appliance.















Basic setting	Selection
Language	See selection on the appliance
Time	00:00 - 23:59
Date	Day, month and year
Favourites → "Changing your favourites", Page 14	Set the heating functions that you want to appear in the heating functions menu
Audible signal duration	<ul style="list-style-type: none"> ■ Short ■ Medium ■ Long
Button tone	<ul style="list-style-type: none"> ■ Off (except for ) ■ On
Display brightness	5 settings
Clock display	<ul style="list-style-type: none"> ■ Digital ■ Off
Lighting	<ul style="list-style-type: none"> ■ On during operation ■ Off during operation
Automatic childproof lock	<ul style="list-style-type: none"> ■ Deactivated ■ Activated
Operation after switch-on	<ul style="list-style-type: none"> ■ Main menu ■ Types of heating
Night-time dimming	<ul style="list-style-type: none"> ■ Switched off ■ On (display dimmed between 10 p.m. and 5.59 a.m.)

¹ Depending on the appliance specifications

Basic setting	Selection
Brand logo	<ul style="list-style-type: none"> ■ Indicators/symbols ■ Do not display
Fan run-on time	<ul style="list-style-type: none"> ■ Recommended ■ Minimum
Pull-out rail system ¹	<ul style="list-style-type: none"> ■ No (rack or single set of pull-out rails fitted) ■ Yes (two or three sets of pull-out rails retrofitted)
Factory settings	Load

¹ Depending on the appliance specifications

12.2 Changing basic settings



1. Press  to switch the appliance on.
2. Press .
3. Use the  or  button to select "Settings" .
4. Use the  button to navigate to the next row.
5. Use the  or  button to select a setting.
6. Use the  button to navigate to the next row.
7. Use the  or  button to change the setting.
8. Press .
9. To save your settings, use the  button to select "Save".
 - To discard your settings, use the  button to select "Discard".

12.3 Changing your favourites













In Favourites, you can set the heating functions that you want to appear in the heating functions menu.

Note:



Some heating functions cannot be deactivated:

- CircoTherm hot air 
- Circo-roasting 
- Full-surface grill 

1. Press  to switch the appliance on.

2. Press .
3. Use the  or  button to select "Settings" .
4. Use the  button to navigate to the next row.
5. Use the  or  button to select "Favourites".
6. Use the  button to navigate to the next row.
7. Use the  or  button to select the required heating function.
8. Use the  button to navigate to the next row.
9. Use the  or  button to select a setting.

Setting	Display in the heating functions menu?
Activated	Yes
Deactivated	No

10. Press .
11. To save your settings, use the  button to select "Save".
 - To discard your settings, use the  button to select "Discard".

13 Cleaning and servicing

To keep your appliance working efficiently for a long time, it is important to clean and maintain it carefully.

13.1 Cleaning products

In order to avoid damaging the various oven surfaces on the appliance, do not use unsuitable cleaning products.

WARNING – Risk of electric shock!

An ingress of moisture can cause an electric shock.

- ▶ Do not use steam- or high-pressure cleaners to clean the appliance.

ATTENTION!

Unsuitable cleaning products may damage the surfaces of the appliance.

- ▶ Do not use harsh or abrasive cleaning products.

- ▶ Do not use cleaning products with a high alcohol content.
 - ▶ Do not use hard scouring pads or cleaning sponges.
 - ▶ Do not use any special cleaners for cleaning the appliance while it is hot.
- Using oven cleaner in a hot cooking compartment damages the enamel.
- ▶ Never use oven cleaner in the cooking compartment when it is still warm.
 - ▶ Remove all food remnants from the cooking compartment and the appliance door before you next heat up the appliance.

New sponge cloths contain residues from production.

- ▶ Wash new sponge cloths thoroughly before use.

Suitable cleaning agents

Only use cleaning agents that are suitable for the different surfaces on your appliance.

Follow the instructions on cleaning the appliance.
→ "Cleaning the appliance", Page 16

Appliance front

Surface	Suitable cleaning agents	Information
Stainless steel	<ul style="list-style-type: none"> ▪ Hot soapy water ▪ Special stainless steel cleaning products suitable for hot surfaces 	To prevent corrosion, remove any limescale, grease, starch or albumin (e.g. egg white) stains on stainless steel fronts immediately. Apply a thin layer of the stainless steel cleaning product with a soft cloth.
Plastic or painted surfaces E.g. control panel	<ul style="list-style-type: none"> ▪ Hot soapy water 	Do not use glass cleaner or a glass scraper. To avoid permanent stains, remove any descaling agent that gets onto the surface immediately.

Appliance door

Area	Suitable cleaning agents	Information
Door panels	<ul style="list-style-type: none"> ▪ Hot soapy water 	Do not use a glass scraper or a stainless steel wool. Tip: Remove the door panels in order to clean them thoroughly. → "Appliance door", Page 19
Door cover	<ul style="list-style-type: none"> ▪ Made of stainless steel: Stainless steel cleaner ▪ Made of plastic: Hot soapy water 	Do not use glass cleaner or a glass scraper. Do not use stainless steel care products. Tip: Remove the door cover for thorough cleaning. → "Appliance door", Page 19
Stainless steel interior door frame	Stainless steel cleaner	Discolouration can be removed using stainless steel cleaner. Do not use stainless steel care products.

Area	Suitable cleaning agents	Information
Door handle	<ul style="list-style-type: none"> ▪ Hot soapy water 	To avoid permanent stains, remove any descaling agent that gets onto the surface immediately.
Door seal	<ul style="list-style-type: none"> ▪ Hot soapy water 	Do not remove or scrub.

Cooking compartment

Area	Suitable cleaning agents	Information
Enamel surfaces	<ul style="list-style-type: none"> ▪ Hot soapy water ▪ Vinegar water ▪ Oven cleaner 	<p>Soak any heavily soiled areas and use a brush or steel wool. Leave the appliance door open to dry the cooking compartment after cleaning it.</p> <p>Notes</p> <ul style="list-style-type: none"> ▪ Enamel burns at very high temperatures, causing minor discoloration. The functionality of your appliance is not affected by this. ▪ The edges of thin trays cannot be completely enamelled and may be rough. This does not impair corrosion protection. ▪ Food residues will leave a white coating on the enamel surfaces. The coating does not pose a health risk. The functionality of your appliance is not affected by this. You can remove residues with lemon juice.
Self-cleaning surfaces	-	<p>Follow the instructions for self-cleaning surfaces. → "Cleaning self-cleaning surfaces in the cooking compartment", Page 16</p>
Glass cover for the oven light	<ul style="list-style-type: none"> ▪ Hot soapy water 	Use oven cleaner to remove very heavy soiling.
Rails	<ul style="list-style-type: none"> ▪ Hot soapy water 	<p>Soak any heavily soiled areas and use a brush or steel wool.</p> <p>Note: To clean thoroughly, detach the rails. → "Rails", Page 18</p>
Accessories	<ul style="list-style-type: none"> ▪ Hot soapy water ▪ Oven cleaner 	<p>Soak any heavily soiled areas and use a brush or steel wool. Enamelled accessories are dishwasher-safe.</p>

13.2 Cleaning the appliance

In order to avoid damaging the appliance, you must clean your appliance only as specified, and with suitable cleaning products.

WARNING – Risk of burns!

The appliance and its parts that can be touched become hot during use.

- ▶ Caution should be exercised here in order to avoid touching heating elements.
- ▶ Young children under 8 years of age must be kept away from the appliance.

WARNING – Risk of fire!

Loose food remnants, fat and meat juices may catch fire.

- ▶ Before using the appliance, remove the worst of the food residues and remnants from the cooking compartment, heating elements and accessories.

Requirement: Read the information on cleaning products.

→ "Cleaning products", Page 15

1. Clean the appliance using hot soapy water and a dish cloth.

- For some surfaces, you can use alternative cleaning agents.

→ "Suitable cleaning agents", Page 15

2. Dry with a soft cloth.

13.3 Cleaning self-cleaning surfaces in the cooking compartment

The back panel, ceiling and side walls in the cooking compartment are self-cleaning and have a coarse surface.

ATTENTION!

If you do not clean the self-cleaning surfaces regularly, they may become damaged.

- ▶ If dark stains are visible on the self-cleaning surfaces, use the cleaning function to clean the cooking compartment.
- ▶ If a prompt to clean appears in the display, use the cleaning function to clean the cooking compartment.
- ▶ Do not use oven cleaner or abrasive cleaning aids. If oven cleaner accidentally comes into contact with the self-cleaning surfaces, dab it off immediately using water and a sponge cloth. Do not rub.
- ▶ Use the cleaning function.
→ "EcoClean cleaning function", Page 17

14 Cleaning functions

You can use the cleaning functions to clean the appliance.

14.1 "EcoClean" cleaning function

Use the "EcoClean" cleaning function regularly to help retain the cleaning ability of the self-cleaning surfaces and prevent damage.

The self-cleaning surfaces in the cooking compartment are coated with a porous, matt ceramic layer and have a rough surface. When the appliance is in operation, the self-cleaning surfaces absorb splashes from roasting or grilling and break them down.

The following surfaces are self-cleaning:

- Back wall
- Ceiling
- Side walls

ATTENTION!

If you do not clean the self-cleaning surfaces regularly, they may become damaged.

- ▶ If dark stains are visible on the self-cleaning surfaces, use the cleaning function to clean the cooking compartment.
- ▶ If a prompt to clean appears in the display, use the cleaning function to clean the cooking compartment.
- ▶ Do not use oven cleaner or abrasive cleaning aids. If oven cleaner accidentally comes into contact with the self-cleaning surfaces, dab it off immediately using water and a sponge cloth. Do not rub.

Cleaning recommendation

The appliance records the type and duration of the operation and, if required, recommends which cleaning function to use.

When you switch on the appliance, a notification appears in the display stating that you should use the cleaning function. Start the cleaning function as soon as possible.

You can use your appliance as normal. However, the cleaning setting appears in the display until you have run the cleaning function in full.

Note: If the appliance is prematurely contaminated, e.g. by greasy poultry or roasts, or if dark spots appear on the self-cleaning surfaces, do not wait until the notification appears in the display before you use the cleaning functions. The more often you use the cleaning function, the longer the cleaning ability of the self-cleaning surfaces is retained.

Preparing the appliance for the cleaning function

In order to achieve a good cleaning result, prepare the appliance carefully.

ATTENTION!

Using oven cleaner on the self-cleaning surfaces damages the surfaces.

- ▶ Do not use oven cleaner on the self-cleaning surfaces. If oven cleaner does get onto these surfaces, dab it off immediately using water and a sponge cloth. Do not rub the surface and do not use abrasive cleaning aids.

1. Remove accessories and cookware from the cooking compartment.
2. Detach the shelf supports and remove them from the cooking compartment.
→ "Rails", Page 18
3. Remove coarse dirt using soapy water and a soft cloth:
 - From the cooking compartment floor
 - From the inside of the appliance door
 - From the glass cover on the oven light
 This prevents stains that cannot be removed.
4. Remove any objects from the cooking compartment. The cooking compartment must be empty.









Configuring the "EcoClean" cleaning function

WARNING – Risk of burns!

 The outside of the appliance gets very hot when the cleaning function is in progress.

- ▶ Never touch the appliance door.
- ▶ Allow the appliance to cool down.
- ▶ Keep children at a safe distance.

Requirements

- Prepare the appliance for the cleaning function.
→ Page 17
 - Do not open the appliance door while the appliance is in operation, as this will abort the cleaning function.
1. Press  to switch the appliance on.
 2. Press .
 3. Use the  or  button to set "EcoClean" .
 4. Use the  button to navigate to the next row.
 - ✓ The duration of the cleaning function will appear on the display.
 5. Use the  button to navigate to the next row.
 6. **Note:** Keep the kitchen ventilated while the cleaning function is running.
Press  to start the cleaning function.
 - ✓ The cleaning function will start. The duration will count down on the display.
 - ✓ Once the cleaning function has run through to the end, an audible signal will sound.
 7. Press any button to end the audible signal.
 8. After using the cleaning function, wipe down the cooking compartment.
→ "Wiping the appliance clean following the cleaning function", Page 17

Wiping the appliance clean following the cleaning function

1. Allow the appliance to cool down.
2. Wipe the cooking compartment with a damp cloth.
Note: Marks may appear on the self-cleaning surfaces. Residues of sugar and egg white in the food are not removed and stick to the surfaces. Red stains are residues from salty food – they are not rust. The stains are not hazardous to health. These marks do not impair the cleaning ability of the self-cleaning surfaces.
3. Attach the shelf supports.
→ "Rails", Page 18

14.2 "EasyClean" cleaning aid

You can use the "EasyClean" cleaning aid to clean light soiling from the cooking compartment between full cleans. The "EasyClean" cleaning aid soaks dirt by evaporating soapy water. It is then easier to remove the dirt.

Setting the "EasyClean" cleaning aid

⚠ WARNING – Risk of scalding!

If there is water in the cooking compartment when it is hot, this may create hot steam.

- ▶ Never pour water into the cooking compartment when the cooking compartment is hot.

Requirements

- You can only start the cleaning aid once the cooking compartment is cold (room temperature) and the appliance door is closed.
- Do not open the appliance door while the appliance is in operation, as this will abort the cleaning aid.
- To remove particularly stubborn dirt, leave the soapy water to work for a while before starting the cleaning aid.
- To remove particularly stubborn dirt, rub washing-up liquid onto dirty areas on the smooth surfaces before starting the cleaning aid.

1. Remove any accessories from the cooking compartment.

2. **ATTENTION!**

Distilled water in the cooking compartment leads to corrosion.

- ▶ Do not use distilled water.

Mix 0.4 litres water with a drop of washing-up liquid and pour into the centre of the cooking compartment floor.

3. Press **⏻** to switch the appliance on.

4. Press **⏻**.
5. Use the **<** or **>** button to select "EasyClean" **⏻**.
6. Use the **~** button to navigate to the next row.
7. Press **▶** to start the cleaning aid.
 - ✓ The cleaning aid will start. The duration will count down on the display.
 - ✓ Once the cleaning aid has run through to the end, an audible signal will sound.
8. Press any button to end the audible signal.
9. After using the cleaning aid, finish cleaning the cooking compartment.
 - "Wiping down the cooking compartment", Page 18

Wiping down the cooking compartment

ATTENTION!

The prolonged presence of moisture in the cooking compartment leads to corrosion.

- ▶ After using the cleaning aid, wipe the cooking compartment clean and allow it to dry fully.

Requirement: The cooking compartment must have cooled down.

1. Open the appliance door and remove the remaining water with an absorbent sponge cloth.
2. Clean the smooth surfaces in the cooking compartment with a dish cloth or a soft brush. Remove stubborn food remnants using a stainless steel scouring pad.
3. Remove limescale with a cloth soaked in vinegar. Then wipe with clean water and rub dry with a soft cloth (including under the door seal).
4. If there is any stubborn dirt that you are unable to remove, run the cleaning aid again once the cooking compartment has cooled down.
5. In order to dry the cooking compartment, leave the appliance door open in the detent position (approx. 30°) for approx. one hour.

15 Rails

To thoroughly clean the rails and the cooking compartment, or to replace the rails, you can remove the rails.

15.1 Detaching the rails

⚠ WARNING – Risk of burns!

The shelf supports get very hot

- ▶ Never touch the shelf supports when hot.
- ▶ Always allow the appliance to cool down.
- ▶ Keep children at a safe distance.

1. Lift the rail forwards slightly **①** and detach it **②**.

2. Pull the whole rail to the front **③** and remove it.

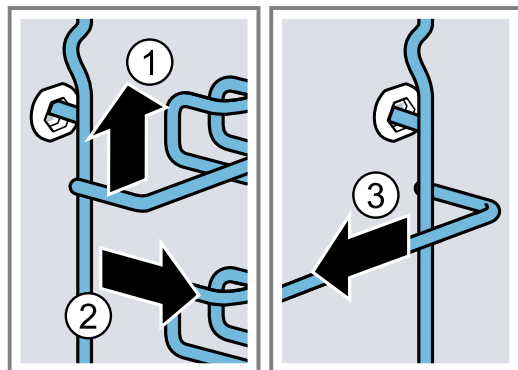

3. Clean the rail.
→ "Cleaning products", Page 15

15.2 Attaching the rails

Notes

- The rails only fit on the right or left.
- For both rails, ensure that the retaining bracket is at the front.

1. First, push the rail into the middle of the rear socket ① until the rail rests against the cooking compartment wall, and then push this back ②.

2. Push the rail into the front socket ③ until the rail also rests against the cooking compartment wall, and then press this downwards ④.

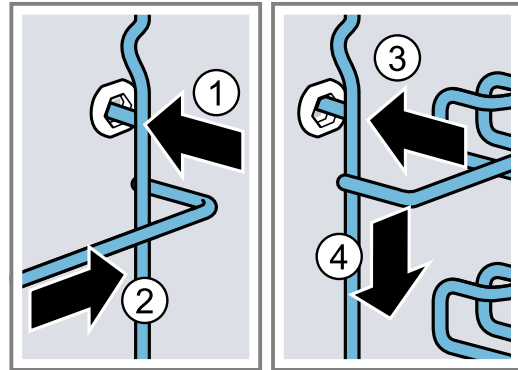

16 Appliance door

To clean the appliance door thoroughly, you can disassemble the appliance door.

16.1 Detaching the appliance door

⚠ WARNING – Risk of injury!

Components inside the appliance door may have sharp edges.

- ▶ Wear protective gloves.

The hinges on the appliance door move when the door is opened and closed, which could trap your fingers.

- ▶ Keep your hands away from the hinges.

1. Open the appliance door fully.

2. **⚠ WARNING – Risk of injury!**

When the hinges are not secured, they can snap shut with great force.

- ▶ Make sure that the locking levers are always either fully closed or (when detaching the oven door) fully open.

Open the locking levers on the left- and right-hand hinges.

Locking levers opened

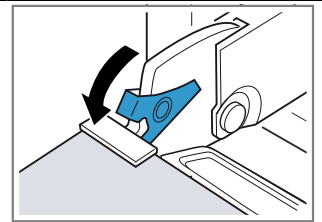

The hinge is now secured and cannot snap shut.

Locking levers closed

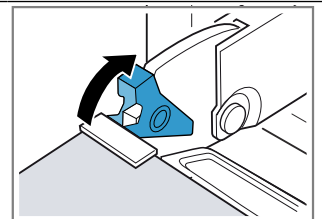

The appliance door is secured and cannot be detached.

- ✓ The locking levers are open. The hinges are now secured and cannot snap shut.
3. Close the appliance door fully ①. Grab hold of the appliance door with both hands (on the left and right) and pull it upwards and out ②.
 4. Carefully place the appliance door on a level surface.

16.2 Attaching the appliance door

⚠ WARNING – Risk of injury!

The hinges on the appliance door move when the door is opened and closed, which could trap your fingers.

- ▶ Keep your hands away from the hinges.

When the hinges are not secured, they can snap shut with great force.

- ▶ Make sure that the locking levers are always either fully closed or (when detaching the oven door) fully open.

1. Slide the appliance door straight onto the two hinges ①. Slide the appliance door on as far as it will go.
2. Open the appliance door fully.
3. Close the locking levers on the left- and right-hand hinges ②.

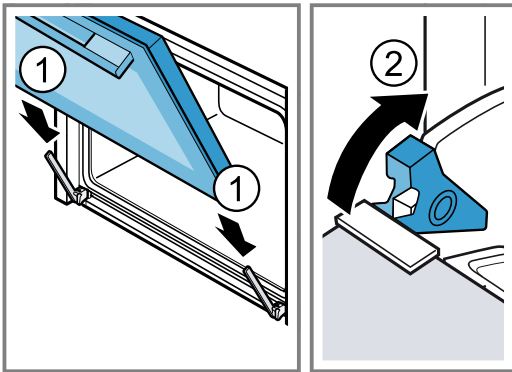

- ✓ The locking levers are closed. The appliance door is secured and cannot be detached.

4. Close the appliance door.

16.3 Removing the door panes

⚠ WARNING – Risk of injury!

The hinges on the appliance door move when the door is opened and closed, which could trap your fingers.

- ▶ Keep your hands away from the hinges.

Components inside the appliance door may have sharp edges.

- ▶ Wear protective gloves.

1. Open the appliance door fully.
 2. Open the locking levers on the left- and right-hand hinges ①.
- ✓ The locking levers are open. The hinges are now secured and cannot snap shut.
3. Close the appliance door fully ②.

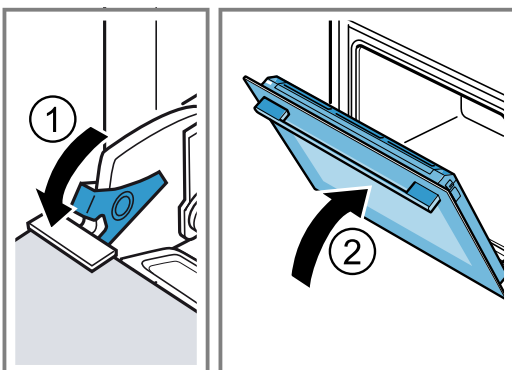

4. Push on the left- and right-hand side of the door cover from the outside ① until it is released.

5. Remove the door cover ②.

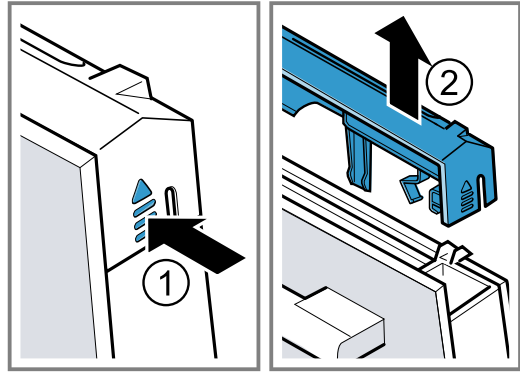

6. Lift out the inner pane ① and set it down carefully on a flat surface.
7. Lift out the intermediate pane ② and set it down carefully on a flat surface.

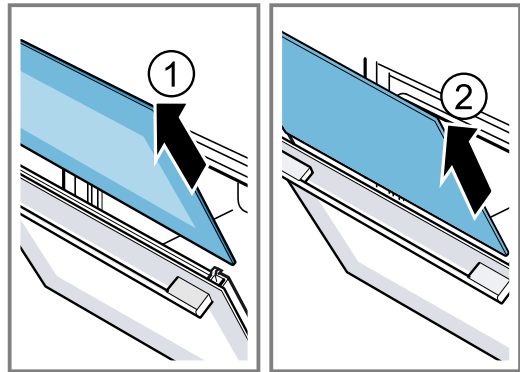

8. Open the appliance door and remove the door seal.

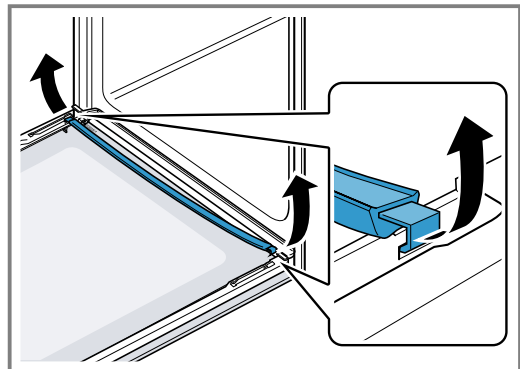

9. If necessary, you can remove the condensate trough for cleaning.
 - Open the appliance door.
 - Tilt the condensate trough upwards and remove it.

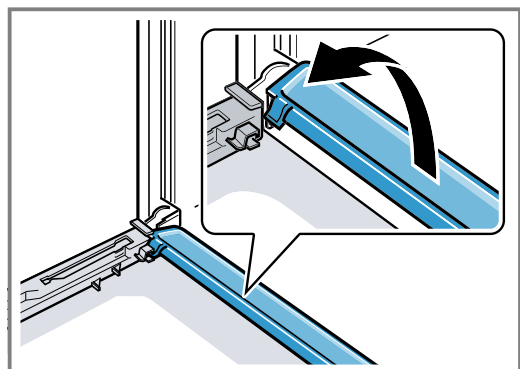

10. ⚠ WARNING – Risk of injury!

Scratched glass in the appliance door may develop into a crack.

- ▶ Do not use any harsh or abrasive cleaners or sharp metal scrapers to clean the glass on the oven door, as they may scratch the surface.

Clean the removed door panes on both sides with glass cleaner and a soft cloth.

11. Clean the condensate trough with a cloth and hot soapy water.
12. Clean the appliance door.
→ "Suitable cleaning agents", Page 15
13. Dry the door panes and refit them.

16.4 Fitting the door panes**⚠ WARNING – Risk of injury!**

The hinges on the appliance door move when the door is opened and closed, which could trap your fingers.

- ▶ Keep your hands away from the hinges.
- Components inside the appliance door may have sharp edges.
- ▶ Wear protective gloves.

1. Open the appliance door fully.
2. Place the condensate trough vertically into the retainer **a** and turn it downwards.

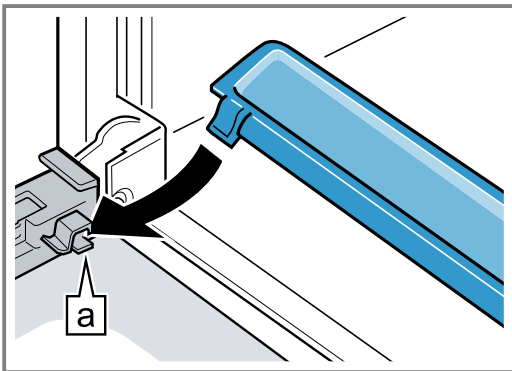

3. Slide the intermediate pane into the left- and right-hand retainers **a**.

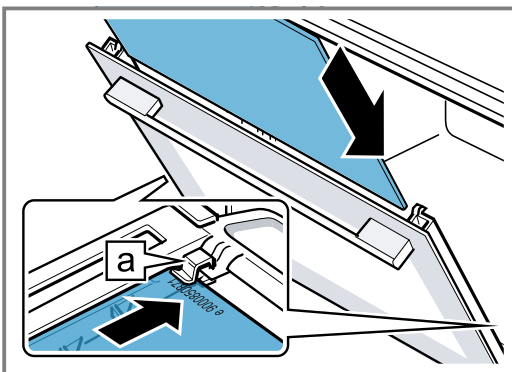

4. Push the intermediate pane upwards until it is in the left- and right-hand retainers **a**.

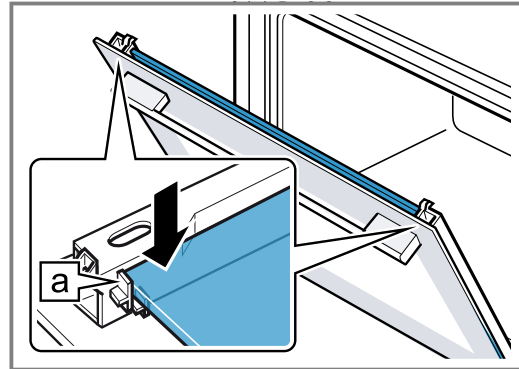

5. Open the appliance door and attach the door seal.

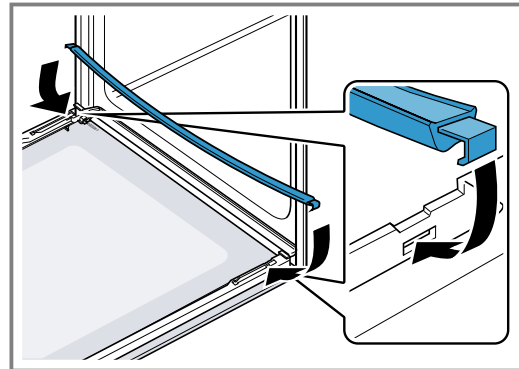

6. Slide the inner pane into the left- and right-hand retainers **a**.

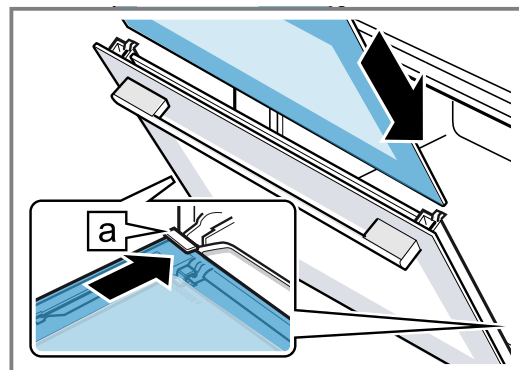

7. Push the inner pane upwards until it is in the left- and right-hand retainers **a**.

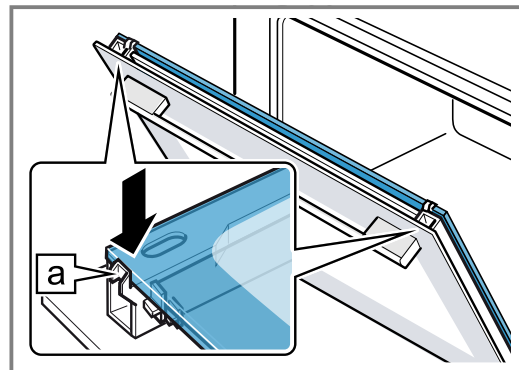

8. Put the door cover in position **1** and push down on it until you hear it click into place.
9. Open the appliance door fully.

10. Close the locking levers on the left- and right-hand hinges ②.

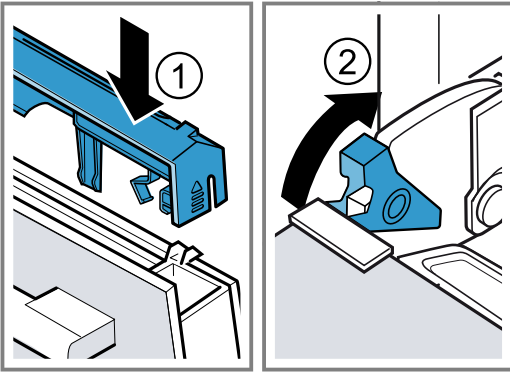

- ✓ The locking levers are closed. The appliance door is secured and cannot be detached.

11. Close the appliance door.

Note: Do not use the cooking compartment again until the door panes have been correctly fitted.

17 Troubleshooting

You can rectify minor faults on your appliance yourself. Read the troubleshooting information before contacting after-sales service. This will avoid unnecessary costs.

⚠ WARNING – Risk of injury!

Improper repairs are dangerous.



- ▶ Repairs to the appliance should only be carried out by trained specialist staff.
- ▶ If the appliance is defective, call Customer Service.



⚠ WARNING – Risk of electric shock!

Incorrect repairs are dangerous.

- ▶ Repairs to the appliance should only be carried out by trained specialist staff.
- ▶ Only use genuine spare parts when repairing the appliance.
- ▶ If the power cord of this appliance is damaged, it must be replaced by trained specialist staff.

17.1 Malfunctions

Fault	Cause and troubleshooting
The appliance is not working.	<p>The circuit breaker is faulty.</p> <ul style="list-style-type: none"> ▶ Check the circuit breaker in the fuse box. <hr/> <p>There has been a power cut.</p> <ul style="list-style-type: none"> ▶ Check whether the lighting in your kitchen or other appliances are working. <hr/> <p>Electronics fault</p> <ol style="list-style-type: none"> 1. Briefly disconnect the appliance from the power supply by switching off the fuse. 2. Reset the basic settings to the factory settings. → "Basic settings", Page 14
"Language English" appears on the display.	<p>There has been a power cut.</p> <ul style="list-style-type: none"> ▶ Configure the initial configuration settings. → "Initial use", Page 10
"-H-" or "-h-" appears on the display.	<p>Cooking compartment too hot for operating mode.</p> <ol style="list-style-type: none"> 1. Wait until the appliance has cooled down. 2. Start the operating mode again.
The appliance cannot be switched on;  appears on the display.	<p>Automatic childproof lock or childproof lock is activated</p> <ul style="list-style-type: none"> ▶ Press and hold the  button until "Childproof lock deactivated" appears on the display.
Appliance will not start or cuts out during operation.	<p>Different causes are possible.</p> <ul style="list-style-type: none"> ▶ Check any notifications that appear on the display. → "Displaying information", Page 11 <hr/> <p>Malfunction</p> <ul style="list-style-type: none"> ▶ Call the after-sales service. → "Customer Service", Page 24

Fault	Cause and troubleshooting
The appliance is not heating;  appears on the display.	Demo mode is activated in the basic settings. <ol style="list-style-type: none"> <li data-bbox="352 230 1487 286">1. Briefly disconnect the appliance from the power supply by switching the circuit breaker in the fuse box off and then on again. <li data-bbox="352 286 1487 342">2. Deactivate Demo mode within the next 3 minutes in the → <i>"Basic settings", Page 14.</i> <hr/> There has been a power cut. <ul style="list-style-type: none"> <li data-bbox="352 387 1487 421">▶ Open and close the appliance door once after a power failure. <li data-bbox="352 421 1487 454">✓ The appliance will perform a self-test, after which it will be ready to use.
Time not displayed when appliance switched off.	Basic setting has been changed. <ul style="list-style-type: none"> <li data-bbox="352 495 1487 555">▶ Change the basic setting for the clock display. → <i>"Basic settings", Page 14</i>
The interior lighting does not work.	The halogen lamp is defective. <ul style="list-style-type: none"> <li data-bbox="352 595 1487 656">▶ Change the oven light bulb. → <i>"Replacing the oven light bulb", Page 23</i>
Maximum operating time reached.	To prevent the appliance from continuing to run when it is no longer needed, it automatically stops heating after a few hours if the settings are not changed during this time. A notification appears on the display. The point at which the maximum operating time is reached is determined by the corresponding settings for an operating mode. <ol style="list-style-type: none"> <li data-bbox="352 819 1487 853">1. Press any button to continue operation. <li data-bbox="352 853 1487 887">2. If you do not need to use the appliance, press  to switch it off. <p data-bbox="352 887 1487 969">Tip: To prevent the appliance from switching off when you do not want it to, set a cooking time. → <i>"Setting the cooking time", Page 12</i></p>
A message with "D" or "E" appears in the display, e.g. D0111 or E0111.	The electronics have detected a fault. <ol style="list-style-type: none"> <li data-bbox="352 1010 1487 1043">1. Switch the appliance off and on again. <ul style="list-style-type: none"> <li data-bbox="352 1043 1487 1077">✓ If the fault was a one-off, the message disappears. <li data-bbox="352 1077 1487 1167">2. If the message appears again, call the after-sales service. Please specify the exact error message when calling. → <i>"Customer Service", Page 24</i>
The cooking result is not satisfactory.	Settings were unsuitable. Setting values, e.g. temperature or cooking time, depend on the recipe, quantity and food. <ul style="list-style-type: none"> <li data-bbox="352 1234 1487 1267">▶ Next time, set lower or higher values. <p data-bbox="352 1267 1487 1330">Tip: A lot of information about the food preparation and corresponding setting values can be found on our website www.neff-international.com.</p>

17.2 Replacing the oven light bulb

If the light in the cooking compartment fails, change the oven light bulb.

Note: Heat-resistant, 40-watt, 230 V halogen bulbs are available from the after-sales service or specialist retailers. Only use these bulbs. Hold the new halogen bulbs only with a clean, dry towel. This increases the service life of the bulb.

WARNING – Risk of burns!

The appliance and its parts that can be touched become hot during use.

- ▶ Caution should be exercised here in order to avoid touching heating elements.
- ▶ Young children under 8 years of age must be kept away from the appliance.

WARNING – Risk of electric shock!

When changing the bulb, the bulb socket contacts are live.

- ▶ Before replacing the bulb, ensure that the appliance is switched off in order to prevent a potential electric shock.
- ▶ Also unplug the appliance from the mains or switch off the circuit breaker in the fuse box.

Requirements

- The appliance is disconnected from the power supply.
 - The cooking compartment has cooled down.
 - You have a new halogen bulb to replace the old one.
1. Place a tea towel in the cooking compartment to prevent damage.
 2. Turn the glass cover anti-clockwise to remove it .

3. Pull out the halogen bulb without turning it ②.

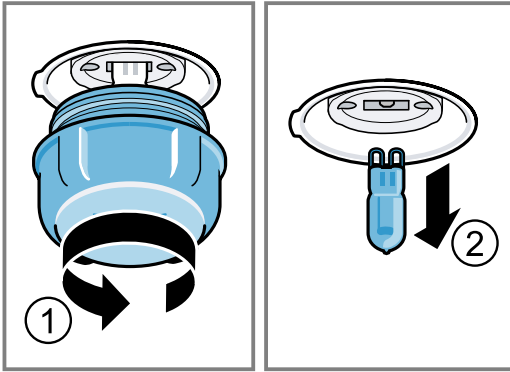

4. Insert the new halogen lamp and press it firmly into the socket.
Make sure the pins are positioned correctly.
5. Depending on the appliance model, the glass cover may have a sealing ring. Put the sealing ring in position.
6. Screw the glass cover on.
7. Take the tea towel out of the cooking compartment.
8. Connect the appliance to the power supply.

18 Disposal

18.1 Disposing of old appliance

Valuable raw materials can be reused by recycling.

1. Unplug the appliance from the mains.
2. Cut through the power cord.
3. Dispose of the appliance in an environmentally friendly manner.
Information about current disposal methods are available from your specialist dealer or local authority.



This appliance is labelled in accordance with European Directive 2012/19/EU concerning used electrical and electronic appliances (waste electrical and electronic equipment - WEEE).
The guideline determines the framework for the return and recycling of used appliances as applicable throughout the EU.

19 Customer Service

Function-relevant genuine spare parts according to the corresponding Ecodesign Order can be obtained from Customer Service for a period of at least 10 years from the date on which your appliance was placed on the market within the European Economic Area.

Note: Under the terms of the manufacturer's warranty the use of Customer Service is free of charge.

Detailed information on the warranty period and terms of warranty in your country is available from our after-sales service, your retailer or on our website.

If you contact Customer Service, you will require the product number (E-Nr.) and the production number (FD) of your appliance.

The contact details for Customer Service can be found in the enclosed Customer Service directory or on our website.

This product contains light sources from energy efficiency class G.

19.1 Product number (E-Nr.) and production number (FD)

You can find the product number (E-Nr.) and the production number (FD) on the appliance's rating plate. You will see the rating plate with these numbers if you open the appliance door.

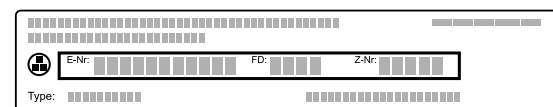

Make a note of your appliance's details and the Customer Service telephone number to find them again quickly.

20 How it works

Here, you can find the ideal settings for various types of food as well as the best accessories and cookware. We have perfectly tailored these recommendations to your appliance.

20.1 General cooking tips

Please take note of the following information when cooking all types of food.

- The temperature and cooking time depend on the amount of food and the recipe. Settings ranges are specified for this reason. Try using the lower values to start with.
- The setting values apply to food placed in the cooking compartment while the cooking compartment is still cold. Do not place accessories into the cooking compartment until it has finished preheating.
- Remove any accessories that are not being used from the cooking compartment.

20.2 Baking tips

- Dark-coloured metal baking tins are most suitable for baking cakes, bread and other baked goods.
- Use wide, shallow cookware for bakes and gratins. Food takes longer to cook in deep, narrow cookware and it browns more on top.
- If you are cooking bakes directly in the universal pan, place the universal pan into the cooking compartment at level 2.
- The setting values for bread dough apply to both dough placed on a baking tray and dough placed in a loaf tin.

ATTENTION!

When the cooking compartment is hot, any water inside it will create steam. The change in temperature may cause damage.

- ▶ Never pour water into the cooking compartment when it is still hot.
- ▶ Never place cookware containing water on the cooking compartment floor.

Shelf positions

If you are using the CircoTherm hot air heating function, you can choose between shelf positions 1, 2, 3 and 4.

Baking on one level	Shelf position
Tall baked items and tins/dishes on the wire rack	2
Shallow baked items/baking trays	3

Baking on two or more levels	Shelf position
2 levels	
■ Universal pan	3
■ Baking tray	1
2 levels	
■ Baking tins on two wire racks	3
	1

Baking on two or more levels	Shelf position
3 levels	
■ Baking tray	4
■ Universal pan	3
■ Baking tray	1
4 levels	
■ 4 wire racks with greaseproof paper	4
	3
	2
	1

Use the CircoTherm hot air heating function.

Note: Items that are placed in the appliance on baking trays or in baking tins/dishes at the same time will not necessarily be ready at the same time.

20.3 Roasting, braising and grilling tips

- The recommended settings are for fridge-temperature food and unstuffed, oven-ready poultry.
- Place the poultry onto the cookware breast-side or skin-side down.
- Turn roasting joints, grilled items or whole fish after approx. $\frac{1}{2}$ to $\frac{2}{3}$ of the specified time.

Calculating the cooking time, e.g. 20+35:

- To calculate the cooking time, assume 20 minutes per 500 g of meat. Then add an extra 35 minutes to that figure.
- For 1.5 kg, the cooking time would therefore be 95 minutes.

Cooking time range, e.g. 10-15:

- Your food will be ready within the specified range of time (in minutes).

Roasting on the wire rack

Food roasted on the wire rack will become very crispy on all sides. You can roast large poultry, for example, or multiple individual pieces at the same time.

- Roast pieces of a similar weight and thickness. The grilled food will brown evenly and will remain succulent and juicy.
- Place the food to be roasted directly on the wire rack.
- To catch any liquids that drip down, place the universal pan, with the wire rack inside it, into the cooking compartment at the specified shelf height.
- Add up to $\frac{1}{2}$ litre of water to the universal pan, depending on the size and type of food that you want to roast.

You can make a sauce from the juices that are collected. This also means that less smoke is produced and the cooking compartment does not become as dirty.

Roasting in cookware

If you cover the cookware when you cook your food, this will keep the cooking compartment cleaner.

General information about roasting in cookware

- Use heat-resistant, ovenproof cookware.
- Place the cookware on the wire rack.

- Glass cookware is best.
- Follow the manufacturer's instructions for your roasting dishes.

Roasting in uncovered cookware

- Use a deep roasting dish.
- If you do not have any suitable cookware, you can use the universal pan.

Roasting in covered cookware

- Use a suitable lid that seals well.
- When roasting meat, there should be at least 3 cm between the food and the lid. The meat may expand.

WARNING – Risk of scalding!

Very hot steam may escape when the lid is opened after cooking. Steam may not be visible, depending on the temperature.

- ▶ Lift the lid in such a way that the hot steam can escape away from you.
- ▶ Keep children away from the appliance.

Grilling

Grill food if you want it to be crispy.

ATTENTION!

Acidic food may damage the grid

- ▶ Do not place acidic food, such as fruit or food with an acidic marinade directly on the pan support.

The "Grill" heating function is good for cooking thinner pieces of poultry, meat and fish such as steaks, drumsticks and burgers. It is also excellent for toasting bread.

Circo-roasting is very well suited to cooking whole poultry and fish, as well as meat, e.g. roast pork with crackling.

- When grilling several food items, choose pieces that are of a similar weight and thickness. The grilled food will brown evenly and will remain succulent and juicy.
- Place the food to be grilled directly onto the wire rack.
- To catch any liquids that drip down, place the universal pan into the cooking compartment at least one level below the wire rack.

Notes

- The grill element switches on and off continuously. This is normal. The temperature that you set determines how frequently this occurs.
- Smoke may be produced when grilling.

Information for those allergic to nickel

In rare cases, small amounts of nickel may pass into the food.





20.4 Cooking instructions for ready meals

- The cooking result greatly depends on the quality of the food. Pre-browning and irregularities are sometimes already present on the raw product.
- Do not use frozen products that are covered with a thick layer of ice. Remove any ice on the food.
- Distribute foods that are in the form of separate pieces, such as bread rolls and potato products, so that they are spread out flat and evenly on the accessory. Leave a little space between the individual pieces.
- Follow the manufacturer's instructions on the packaging.

20.5 List of foods

Recommended settings for a variety of foods, sorted into food categories.

Recommended settings for various types of food

Food	Accessory/cookware	Shelf position	Heating function → <i>Page 7</i>	Temperature in °C	Cooking time in mins
Victoria sponge cake	x 2 Baking tin, dia. 20 cm	2		160–170 ¹	20–25
Rich fruit cake	High Ø 23 cm tin	2		130–150	150–180
Rich fruit cake	High Ø 23 cm tin	2		140–160	120–180
Fruit pie	Plate Ø 20 cm or Pie tin	2		160–170	55–65
Fruit pie	Plate Ø 20 cm or Pie tin	2		170–190	55–70

¹ Preheat the appliance.

² Turn the food after approx. one hour.

³ Preheat the appliance for 5 minutes.

⁴ Preheat the appliance for three minutes.

⁵ Turn the dish several times.

Food	Accessory/cookware	Shelf position	Heating function → Page 7	Temperature in °C	Cooking time in mins
Fruit pie	Plate Ø 20 cm or Pie tin	2		170–190	60–75
Quiche	Dark coated quiche tin	3		190–210	35–45
Bread or white bread	Loaf tin, 1 x 900 g or 2 x 450 g	2		190–210 ¹	25–40
Bread or white bread	Loaf tin, 1 x 900 g or 2 x 450 g	2		180–200 ¹	20–30
Bread or white bread	Loaf tin, 1 x 900 g or 2 x 450 g	2		190–200	40–50
Scones	Baking tray	3		180–200 ¹	10–14
Biscuits	Baking tray	3		140–160 ¹	10–25
Small cakes	12-cup-tin	3		140–160 ¹	20–30
Pavlova	Baking tray	3		90–100 ¹	120–180
Yorkshire pudding	12-cup-tin	3		200–220 ¹	15–25
Pizza, home-made	Baking tray	3		200–220	25–35
Pizza, home-made, thin crust	Pizza tray	2		210–220	25–30
Victoria sponge cake, 2 levels	4 pcs Baking tin, dia. 20 cm	3+1		160–170 ¹	20–25
Biscuits, on 2 levels	x 2 Baking tray	3+1		140 - 160 ¹	10 - 25
Top side, top rump	Wire rack	2		160 - 170	30 + 25
Leg, bone-in	Wire rack	2		160 - 170	25 + 25
Belly	Wire rack	2		170 - 180	30 + 25
Chicken, whole	Wire rack	2		170 - 180	25 + 15
Turkey, crown	Wire rack	2		150 - 160	20 + 15
Turkey, whole, 4-8 kg	Wire rack	2		150 - 160	12 + 12 ²
Diced meat, e.g. beef, pork, lamb, 500 g meat	Covered cookware	2		140 ¹	100 - 120
Diced meat, e.g. beef, pork, lamb, 500 g meat	Covered cookware	2		140	100–120
Complete meal with chicken	Wire rack + Wire rack	4+1		180	Calculation for chicken (see table above)
Bacon rashers	Wire rack	3		290 ³	1. First side 4-5 2. Second side 3-4
Sausages, 2-4 cm thick	Wire rack	3		290 ⁴	10 - 15 ⁵
Belly	Wire rack	2		200 - 220	30 + 25
Gammon joint	Wire rack	2		180 - 200	30 + 25
Chicken, whole	Wire rack	2		200–220	20 + 15
Yoghurt	Individual moulds	Cooking compartment floor		35 - 40	8-9 hrs

¹ Preheat the appliance.² Turn the food after approx. one hour.³ Preheat the appliance for 5 minutes.⁴ Preheat the appliance for three minutes.⁵ Turn the dish several times.

20.6 Special cooking methods and other applications

Information and recommended settings for special cooking methods and other applications, e.g. slow cooking or preserving.

Yoghurt

Use your appliance to make yoghurt.

Making yoghurt

1. Remove the accessories and shelves from the cooking compartment.

2. Heat 1 litre of whole milk (3.5% fat) to 90 °C on the hob and then leave it to cool down to 40 °C. It is sufficient to heat UHT milk to 40 °C.
3. Mix 150 g of chilled yoghurt into the milk.
4. Pour the mixture into small containers, e.g. cups or small jars.
5. Cover the containers with film, e.g. cling film.
6. Place the containers on the cooking compartment floor.
7. Use the recommended settings when configuring the appliance settings.
8. After making the yoghurt, leave it to cool in the refrigerator for at least 12 hours.

Recommended settings for yoghurt

Food	Accessory/cookware	Shelf position	Heating function → Page 7	Temperature in °C	Cooking time in mins
Yoghurt	Individual moulds	Cooking compartment floor		35 - 40	8-9 hrs

Slow cooking

Cook prime cuts of meat slowly at a low temperature, e.g. tender cuts of beef, veal, lamb or poultry.

Low temperature cooking poultry or meat

Note: When using the low temperature cooking type of heating, you cannot delay the start of the programme by setting an end time.

Requirement: The cooking compartment is cold.

1. Use fresh, clean, hygienic meat without bones.
2. Place the cookware onto the wire rack at level 2 in the cooking compartment.
3. Preheat the cooking compartment and cookware for approx. 15 minutes.
4. Sear the meat on all sides on the hob at a very high heat.
5. Immediately place the meat into the pre-warmed cookware in the cooking compartment.
To ensure that the climate in the cooking compartment remains constant, keep the cooking compartment door closed during low temperature cooking.





6. After low temperature cooking, remove the meat from the cooking compartment.

Tips for slow cooking

Here you will find tips for achieving good results when slow cooking food.

Issue	Tip
You want to slow cook a duck breast.	<ul style="list-style-type: none"> Place the cold duck breast into a pan. Sear the skin side first. Slow cook the duck breast. After slow cooking, grill the duck breast for 3 to 5 minutes until crispy.
You want to serve your slow-cooked meat as hot as possible.	<ul style="list-style-type: none"> Preheat the serving plate. Make sure that the sauces that accompany the duck breast are very hot when you serve them.

Recommended settings for slow cooking

Food	Accessory/cookware	Shelf position	Searing time in mins	Heating function → Page 7	Temperature in °C	Cooking time in mins
Duck breast, medium rare, 300 g each	Uncovered cookware	2	6 - 8		90 ¹	45 - 60
Fillet of pork, whole	Uncovered cookware	2	4 - 6		80 ¹	45 - 70
Fillet of beef, 1 kg	Uncovered cookware	2	4 - 6		80 ¹	90 - 120
Veal medallions, 4 cm thick	Uncovered cookware	2	4		80 ¹	30 - 50
Saddle of lamb, boneless, 200 g each	Uncovered cookware	2	4		80 ¹	30 - 45

¹ Preheat the appliance.

Defrosting

You can defrost frozen food in your appliance.

Tips for defrosting food

- You can use the appliance to defrost frozen fruit, vegetables or baked goods.
- It is better to defrost poultry, meat and fish in the refrigerator.
- Remove frozen food from its packaging before you defrost it.
- The recommended settings are for freezer-temperature food (-18 °C).

- When defrosting food, use the following shelf positions:
 - 1 wire rack: Shelf position 2
 - 2 wire racks: Shelf positions 3 + 1
- Stir or turn the food 1-2 times during defrosting. Turn large items several times. Split the food into smaller pieces as it defrosts. Remove pieces that have already defrosted from the cooking compartment.
- Once the food has defrosted, switch off the appliance and leave the food in the appliance for another 10 to 30 minutes to allow the temperature to equalise.

20.7 Test dishes

The information in this section is provided for test institutes to facilitate testing of the appliance in accordance with EN 60350-1.

Baking

- The setting values apply to food that is placed into a cold cooking compartment.
- Please take note of the information on preheating in the recommended settings tables. These setting values assume that the rapid heat-up function is not being used.
- For baking, use the lower of the specified temperatures to start with.
- Items that are placed in the appliance on baking trays or in baking tins/dishes at the same time will not necessarily be ready at the same time.
- Shelf positions when baking on 2 levels:
 - Universal pan: Shelf position 3

- Baking tray: Shelf position 1
- Baking tins/dishes on the wire rack:
 - First wire rack: Shelf position 3
 - Second wire rack: Shelf position 1
- Shelf positions when baking on 3 levels:
 - Baking tray: Shelf position 4
 - Universal pan: Shelf position 3
 - Baking tray: Shelf position 1
- Hot water sponge cake
 - When baking on two levels, place the springform tins at diagonally opposite corners of the wire racks.

Recommended settings for baking

Food	Accessory/cookware	Shelf position	Heating function → Page 7	Temperature in °C	Cooking time in mins
Viennese whirls	Baking tray	3	≡	140 - 150 ¹	25 - 40
Viennese whirls	Baking tray	3	⌘	140 - 150 ¹	25 - 40
Viennese whirls, on 2 levels	Universal pan + Baking tray	3+1	⌘	140 - 150 ¹	30 - 40
Viennese whirls, on 3 levels	x 2 Baking tray + x 1 Universal pan	4+3+1	⌘	130 - 140 ¹	35 - 55
Small cakes	Baking tray	3	≡	160 ¹	20 - 30
Small cakes	Baking tray	3	⌘	150 ¹	25 - 35
Small cakes, on 2 levels	Universal pan + Baking tray	3+1	⌘	150 ¹	25 - 35
Small cakes, on 3 levels	x 2 Baking tray + x 1 Universal pan	4+3+1	⌘	140 ¹	35 - 45

¹ Preheat the appliance for five minutes. Do not use the rapid heating function.

² Preheat the appliance. Do not use the rapid heating function.

Food	Accessory/cookware	Shelf position	Heating function → Page 7	Temperature in °C	Cooking time in mins
Hot water sponge cake	Springform cake tin, diameter 26 cm	2	☰	160 - 170 ²	25 - 35
Hot water sponge cake	Springform cake tin, diameter 26 cm	2	☂	160 - 170 ²	30 - 40
Hot water sponge cake, on 2 levels	Springform cake tin, diameter 26 cm	3+1	☂	150 - 170 ²	30 - 50

¹ Preheat the appliance for five minutes. Do not use the rapid heating function.

² Preheat the appliance. Do not use the rapid heating function.

Recommended settings for grilling

Food	Accessory/cookware	Shelf position	Heating function → Page 7	Temperature in °C	Cooking time in mins
Toasting bread	Wire rack	4	☰	290 ¹	4 - 6

¹ Do not preheat the appliance.

21 Installation instructions

Observe this information when installing the appliance.



⚠ 21.1 General installation instructions

Follow these instructions before you start with the installation of the appliance.

- The safe operation of this appliance can only be guaranteed if it has been installed to a professional standard in accordance with these installation instructions. The installer shall be liable for damages incurred as a result of incorrect installation.
- Do not use the door handle for the transport or installation.
- Check the appliance for damage after unpacking it. Do not connect the appliance if it has been damaged in transit.
- Before starting up the appliance, remove any packaging material and adhesive film from the cooking compartment and the door.
- Proceed in accordance with the installation sheets for installing accessories.
- Fitted units must be heat-resistant up to 95 °C, and adjacent unit fronts up to 70 °C.

- Do not install the appliance behind a decorative door or the door of a kitchen unit. There is a risk of overheating.
- Cut-out work on the units should be carried out before installing the appliance. Remove any shavings. Otherwise, the correct operation of electrical components may be adversely affected.
- The mains socket for the appliance must either be located in the hatched area **a** or outside of the area where the appliance is installed. Any unsecured units must be secured to the wall using a standard bracket **b**.

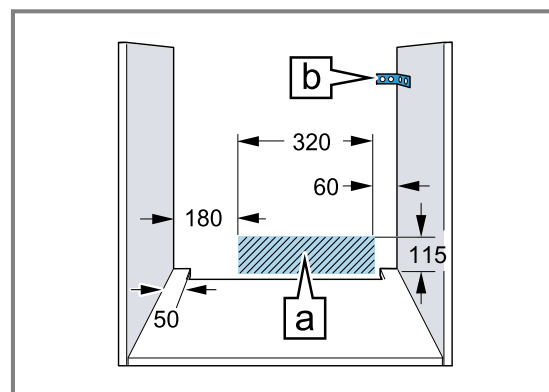

- Wear protective gloves so that you do not cut yourself. Parts that are accessible during installation may have sharp edges.
- Dimensions of the figures in mm.

⚠ WARNING – Danger: Magnetism!

Permanent magnets are used in the control panel or in the controls. They may affect electronic implants, e.g. pacemakers or insulin pumps.

- ▶ Wearers of electronic implants must stay at least 10 cm away from the control panel or controls during the installation.

⚠ WARNING – Risk of fire!

It is dangerous to use an extended power cord and non-approved adapters.

- ▶ Do not use multiple socket strips.
- ▶ Only use extension cables that are certified, have a minimum cross section of 1.5 mm² and comply with the applicable national safety requirements.
- ▶ If the power cord is too short, contact customer service.
- ▶ Only use adapters approved by the manufacturer.

ATTENTION!

Carrying the appliance by the door handle could break it. The door handle cannot support the weight of the appliance.

- ▶ Do not carry or hold the appliance by the door handle.

21.2 Appliance dimensions

You will find the dimensions of the appliance here

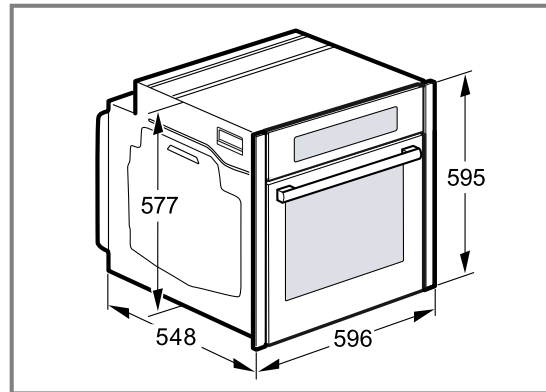
**21.3 Installation below a worktop**

Observe the installation dimensions and the installation instructions when installing below a worktop.

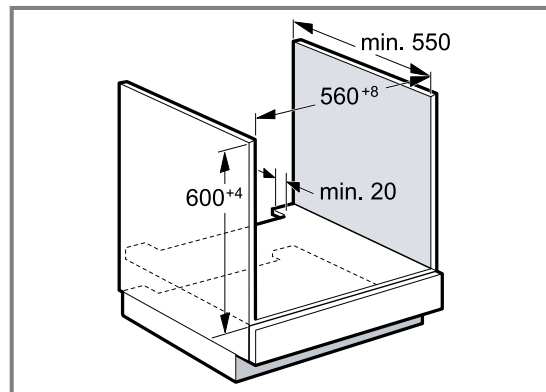

- To ventilate the appliance, the intermediate floor must have a ventilation cut-out.
- The worktop must be secured to the fitted unit.
- Observe any available installation instructions for the hob.
- Observe different national installation instructions for the hob.

21.4 Installation underneath a hob

If the appliance is installed under a hob, the following minimum dimensions must be adhered to (including substructure, if applicable).

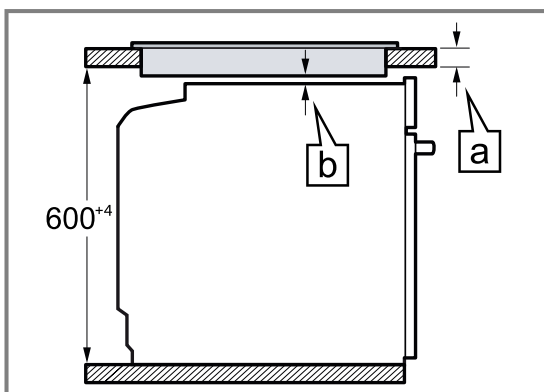

The minimum worktop thickness \boxed{a} is based on the required minimum clearance \boxed{a} .

Hob type	a raised in mm	a flush in mm	b in mm
Induction hob	37	38	5
Full-surface induction hob	47	48	5
Gas hob	27	38	5 ¹
Electric hob	27	30	2

¹ Observe different national installation instructions for the hob.

21.5 Installation in a tall unit

Observe the installation dimensions and the installation instructions when installing in a tall unit.

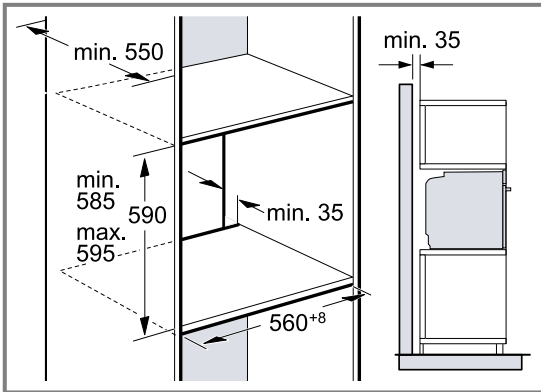

- To ventilate the appliance, the intermediate floors must have a ventilation cut-out.
- If the tall unit has another back panel in addition to the element back panels, this must be removed.
- Only fit the appliance up to a height which allows accessories to be easily removed.

21.6 Installing two appliances on top of each other

Your appliance can also be installed above or below another appliance. Observe the installation dimensions and the installation instructions when installing appliances on top of each other.

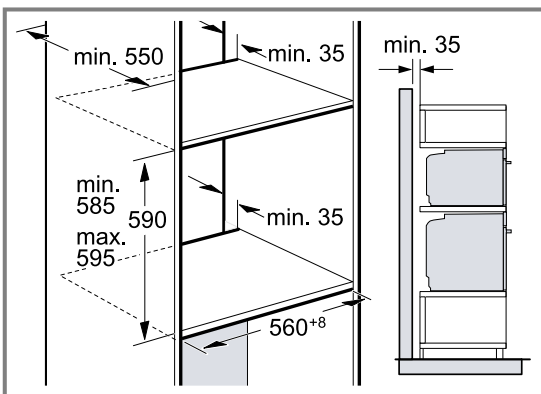

- To ventilate the appliances, the intermediate floor must have a ventilation cut-out.
- To ensure sufficient ventilation of the two appliances, there must be a ventilation opening of at least 200 cm² in the base area. To do this, trim the base panel or fit a ventilation grille.

- Ensure that air exchange is guaranteed in accordance with the diagram.

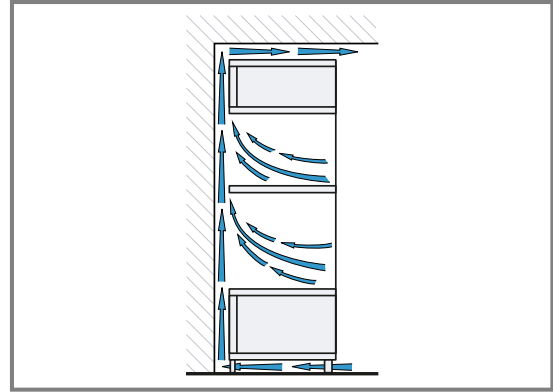

- Only fit appliances up to a height that allows accessories to be easily removed.

21.7 Corner installation

Observe the installation dimensions and the installation instructions when installing in a corner.

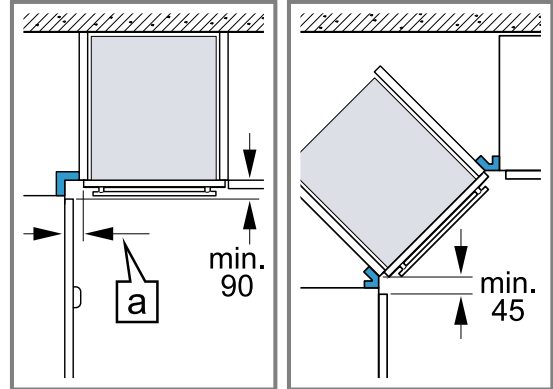

- To ensure that the appliance door can be opened, you must take the minimum dimensions into consideration when installing in a corner. The dimension a is dependent on the thickness of the unit front and the handle.

21.8 Electrical connection

In order to safely connect the appliance to the electrical system, follow these instructions.

- The appliance corresponds to protection class I and must only be operated with a protective earth connection.
- The fuse protection must correspond to the power rating specified on the appliance's rating plate and to the local regulations.
- The appliance must be disconnected from the power supply whenever installation work is being carried out.

- The appliance must only be connected using the power cable provided.
- The power cable must be plugged in at the rear of the appliance until you hear a clicking sound. A 3 m power cable can be obtained from the after-sales service.
- The power cable must only be replaced with a cable from the original manufacturer. This is available from after-sales service.
- Contact protection must be guaranteed by the installation.

Electrically connect the appliance with the protective contact plug

Note: The appliance must only be connected to a protective contact socket that has been correctly installed.

- ▶ Insert the plug into the protective contact socket. When the appliance is installed, the mains plug of the power cord must be freely accessible. If free access is not possible, an isolating switch must be integrated into the permanent electrical installation according to the installation regulations.

Electrically connecting an appliance without a protective contact plug

Note: Only licensed specialists may connect the appliance. Damage caused by incorrect connection is not covered under the warranty. An isolating switch must be integrated into the permanent electrical installation according to the installation regulations.

1. Identify the phase and neutral conductors in the socket.
The appliance may be damaged if it is not connected correctly.
2. Connect the hob in accordance with the connection diagram.
See the rating plate for the voltage.
3. Connect the wires of the mains power cable according to the colour coding:
 - Green/yellow = Protective conductor \oplus
 - Blue = Neutral conductor
 - Brown = Phase (external conductor)

21.9 Installing the appliance

Note: Do not use a cordless screwdriver to secure the panels. This may damage the panels.

1. Push the appliance in fully.
Do not kink or trap the connection cable, or route it over sharp edges.

2. Centre the appliance.

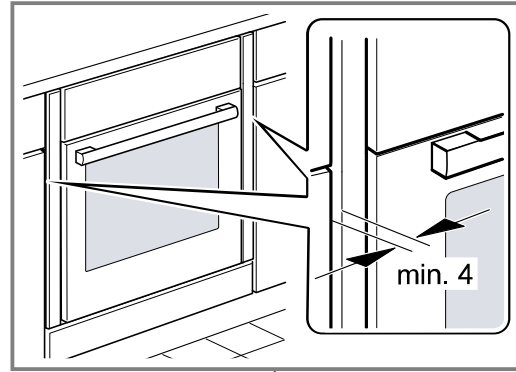

There must be an air gap of at least 4 mm between the appliance and adjacent unit fronts.

3. Open the appliance door and unscrew the left and right-hand panels.

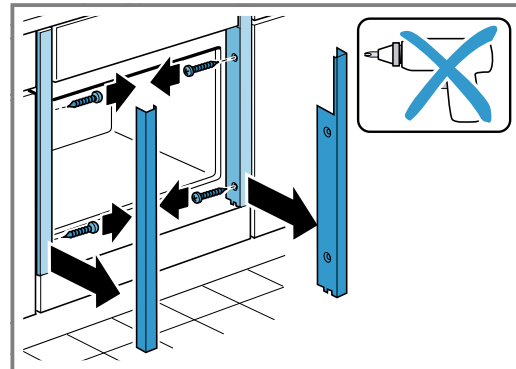

4. Close the appliance door.
5. Screw the appliance into place.

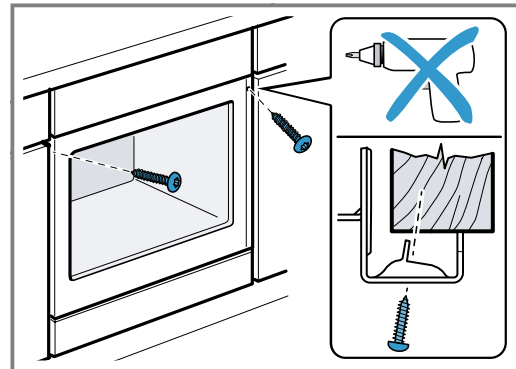

6. For handleless kitchens with vertical bar handle strips:
- Attach a suitable filling piece ① in order to cover any sharp edges and to guarantee a safe installation.
 - Pre-drill aluminium profiles to establish a screw connection ②.
 - Secure the appliance using a suitable screw ③.

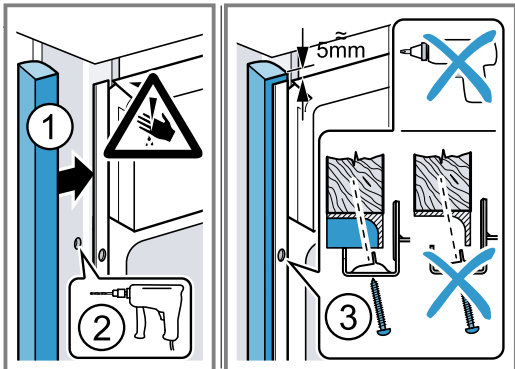

7. Refit the panels and screw them in place, first at the top and then at the bottom.

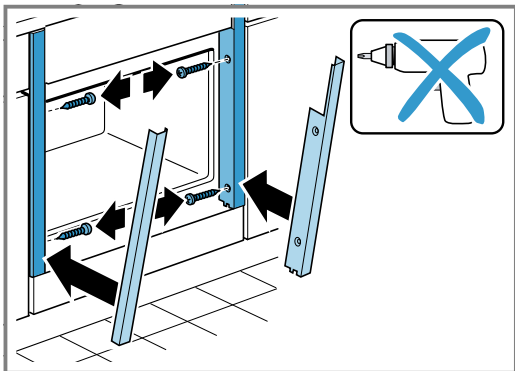

8. If required, the gap between the appliance door and the side panels can be adjusted using the screws at the top left and right.

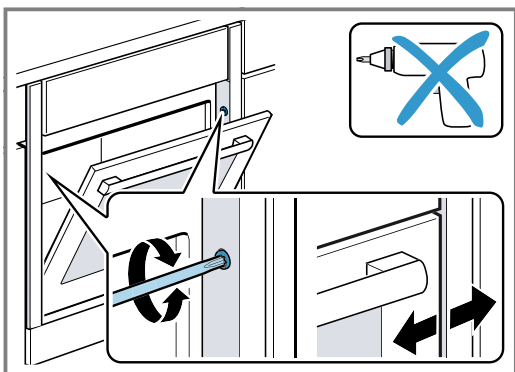

Note: The gap between the worktop and the appliance must not be closed by additional battens. Thermal insulation strips must not be fitted to the side panels of the surround unit.

21.10 Removing the appliance

1. Disconnect the appliance from the power supply.
2. Open the appliance door and unscrew the left and right-hand panels.
3. Undo the fastening screws.
4. Lift the appliance slightly and pull it out completely.

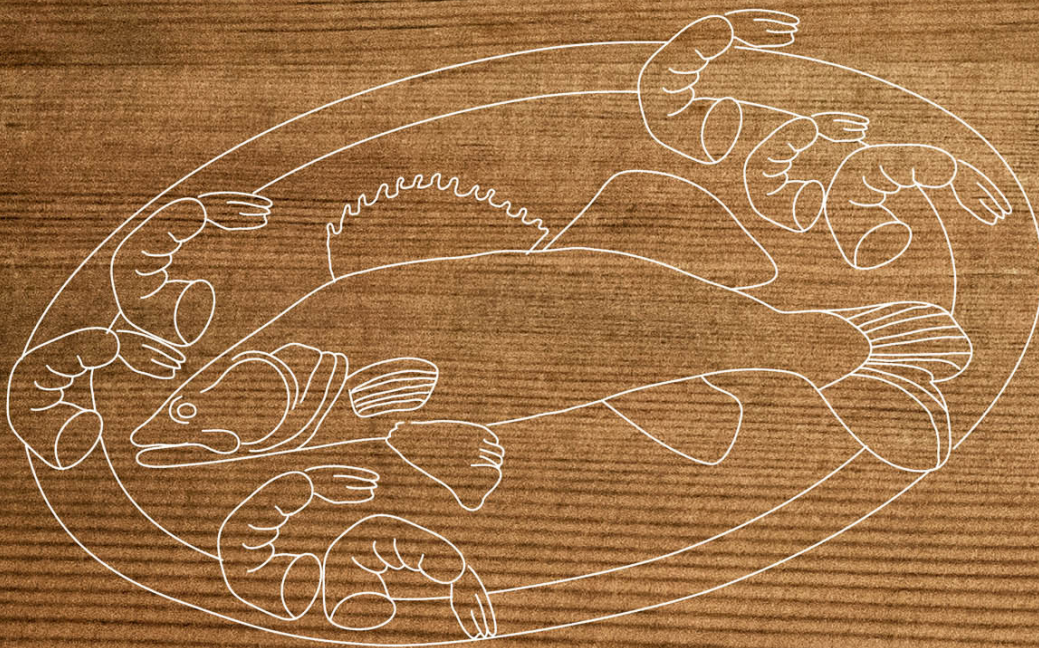

REGISTER YOUR PRODUCT
ONLINE NEFF-HOME.COM

BSH Hausgeräte GmbH
Carl-Wery-Straße 34
81739 München, GERMANY

Valid within Great Britain:
Imported to Great Britain by
BSH Home Appliances Ltd.
Grand Union House
Old Wolverton Road
Wolverton, Milton Keynes
MK12 5PT
United Kingdom



9001621013
020909
en