



Oven

[en] User manual and installation instructions

B47VR22.0

Table of contents

USER MANUAL

1	Safety	2
2	Preventing material damage	4
3	Environmental protection and saving energy	5
4	Familiarising yourself with your appliance	6
5	Accessories	9
6	Before using for the first time	10
7	Basic operation	11
8	Steam	12
9	Time-setting options	15
10	Steam programs	16
11	Childproof lock	17
12	Rapid heat-up	18
13	Sabbath mode	18
14	Basic settings	19
15	Cleaning and servicing	20
16	Cleaning function	22
17	Rails	23
18	Appliance door	24
19	Troubleshooting	28
20	Disposal	30
21	Customer Service	30
22	How it works	31
23	INSTALLATION INSTRUCTIONS	37
23.1	General installation instructions	37

1 Safety

Observe the following safety instructions.

1.1 General information

- Read this instruction manual carefully.
- Keep the instruction manual and the product information safe for future reference or for the next owner.
- Do not connect the appliance if it has been damaged in transit.

1.2 Intended use

This appliance is designed only to be built into kitchen units. Read the special installation instructions.

Only a licensed professional may connect appliances without plugs. Damage caused by incorrect connection is not covered under the warranty.

Only use this appliance:

- To prepare meals and drinks.
- In private households and in enclosed spaces in a domestic environment.
- Up to an altitude of max. 4000 m above sea level.

1.3 Restriction on user group

This appliance may be used by children aged 8 or over and by people who have reduced physical, sensory or mental abilities or inadequate experience and/or knowledge, provided that they are supervised or have been instructed on how to use the appliance safely and have understood the resulting dangers.

Children must not play with the appliance.

Children must not perform cleaning or user maintenance unless they are at least 15 years old and are being supervised.

Keep children under the age of 8 years away from the appliance and power cable.

1.4 Safe use

Always place accessories in the cooking compartment the right way round.

→ "Accessories", Page 9

WARNING – Risk of fire!

Combustible objects that are left in the cooking compartment may catch fire.

- ▶ Never store combustible objects in the cooking compartment.
- ▶ If smoke is emitted, the appliance must be switched off or the plug must be pulled out and the door must be held closed in order to stifle any flames.

Loose food remnants, fat and meat juices may catch fire.

- ▶ Before using the appliance, remove the worst of the food residues and remnants from the cooking compartment, heating elements and accessories.

Opening the appliance door creates a draught. Greaseproof paper may come into

contact with the heating element and catch fire.

- ▶ Never place greaseproof paper loosely over accessories when preheating the appliance and while cooking.
- ▶ Always cut greaseproof paper to size and use a plate or baking tin to hold it down.

⚠ WARNING – Risk of burns!

The appliance and its parts that can be touched become hot during use.

- ▶ Caution should be exercised here in order to avoid touching heating elements.
- ▶ Young children under 8 years of age must be kept away from the appliance.

Accessories and cookware get very hot.

- ▶ Always use oven gloves to remove accessories or cookware from the cooking compartment.

When the cooking compartment is hot, any alcoholic vapours inside may catch fire.

- ▶ Only use small quantities of drinks with a high alcohol content in food.
- ▶ Open the appliance door carefully.

⚠ WARNING – Risk of scalding!

The accessible parts of the appliance become hot during operation.

- ▶ Never touch these hot parts.
- ▶ Keep children at a safe distance.

Hot steam may escape when you open the appliance door. Steam may not be visible, depending on the temperature.

- ▶ Open the appliance door carefully.
- ▶ Keep children at a safe distance.

If there is water in the cooking compartment when it is hot, this may create hot steam.

- ▶ Never pour water into the cooking compartment when the cooking compartment is hot.

⚠ WARNING – Risk of injury!

Scratched glass in the appliance door may develop into a crack.

- ▶ Do not use any harsh or abrasive cleaners or sharp metal scrapers to clean the glass on the oven door, as they may scratch the surface.

The hinges on the appliance door move when the door is opened and closed, which could trap your fingers.

- ▶ Keep your hands away from the hinges.

Components inside the appliance door may have sharp edges.

- ▶ Wear protective gloves.

⚠ WARNING – Risk of electric shock!

Incorrect repairs are dangerous.

- ▶ Repairs to the appliance should only be carried out by trained specialist staff.
- ▶ Only use genuine spare parts when repairing the appliance.
- ▶ If the power cord of this appliance is damaged, it must be replaced by trained specialist staff.

If the insulation of the power cord is damaged, this is dangerous.

- ▶ Never let the power cord come into contact with hot appliance parts or heat sources.
- ▶ Never let the power cord come into contact with sharp points or edges.
- ▶ Never kink, crush or modify the power cord.

An ingress of moisture can cause an electric shock.

- ▶ Do not use steam- or high-pressure cleaners to clean the appliance.

If the appliance or the power cord is damaged, this is dangerous.

- ▶ Never operate a damaged appliance.
- ▶ Never operate an appliance with a cracked or fractured surface.
- ▶ Never pull on the power cord to unplug the appliance. Always unplug the appliance at the mains.
- ▶ If the appliance or the power cord is damaged, immediately unplug the power cord or switch off the fuse in the fuse box.
- ▶ Call customer services. → *Page 30*

⚠ WARNING – Danger: Magnetism!

Permanent magnets are used in the control panel or in the controls. These may affect electronic implants, e.g. heart pacemakers or insulin pumps.

- ▶ Wearers of electronic implants must stay at least 10 cm away from the control panel.

⚠ WARNING – Risk of suffocation!

Children may put packaging material over their heads or wrap themselves up in it and suffocate.

- ▶ Keep packaging material away from children.
- ▶ Do not let children play with packaging material.

Children may breathe in or swallow small parts, causing them to suffocate.

- ▶ Keep small parts away from children.
- ▶ Do not let children play with small parts.

1.5 Steam

Follow these instructions when using a steam function.

⚠ WARNING – Risk of scalding!

The water in the water tank may become very hot if you operate the appliance for long periods.

- ▶ Always empty the water tank after using the steam function.

Hot steam is generated in the cooking compartment.

- ▶ Do not reach into the cooking compartment when using steam.

Hot liquid may spill over the sides of the accessory when it is removed from the cooking compartment.

- ▶ Remove hot accessories with care and always wear oven gloves.

⚠ WARNING – Risk of fire!

Due to the hot surfaces, vapours from flammable liquids may catch fire in the cooking compartment (explosion). The appliance door may spring open. Hot steam and jets of flame may escape.

- ▶ Do not pour flammable liquids (e.g. alcoholic drinks) into the water tank.
- ▶ Only fill the water tank with water or with the descaling solution we have recommended.

2 Preventing material damage

2.1 General

ATTENTION!

Objects on the cooking compartment floor at over 50 °C will cause heat to build up. The baking and roasting times will no longer be correct and the enamel will be damaged.

- ▶ Do not place any accessories, greaseproof paper or foil of any kind on the cooking compartment floor.
- ▶ Only place cookware on the cooking compartment floor if a temperature above 50 °C has been set.

When the cooking compartment is hot, any water inside it will create steam. The change in temperature may cause damage.

- ▶ Never pour water into the cooking compartment when it is still hot.
- ▶ Never place cookware containing water on the cooking compartment floor.

The prolonged presence of moisture in the cooking compartment leads to corrosion.

- ▶ Allow the cooking compartment to dry after use.
- ▶ Do not keep moist food in the cooking compartment for a long time with the door closed.
- ▶ Do not store food in the cooking compartment.

Leaving the appliance to cool down with the door open will damage the front of neighbouring kitchen units over time.

- ▶ Always allow the cooking compartment to cool down with the door closed after cooking at high temperatures.
- ▶ Take care not to trap anything in the appliance door.
- ▶ Only leave the cooking compartment to dry with the door open if a lot of moisture was produced during operation.

Fruit juice dripping from the baking tray leaves stains that cannot be removed.

- ▶ When baking very juicy fruit flans, do not pack too much on the baking tray.

- ▶ If possible, use the deeper universal pan. Using oven cleaner in a hot cooking compartment damages the enamel.
- ▶ Never use oven cleaner in the cooking compartment when it is still warm.
- ▶ Remove all food remnants from the cooking compartment and the appliance door before you next heat up the appliance.

If the seal is very dirty, the appliance door will no longer close properly during operation. This may damage the front of adjacent kitchen units.

- ▶ Keep the seal clean at all times.
- ▶ Never operate the appliance if the seal is damaged or missing.

Sitting or placing objects on the appliance door may damage it.

- ▶ Do not place or hang objects on the appliance door.
- ▶ Do not place cookware or accessories on the appliance door.

With certain models, accessories may scratch the door pane when closing the appliance door.

- ▶ Always push accessories fully into the cooking compartment.

2.2 Steam

Follow these instructions when using the steam function.

ATTENTION!

Silicone bakeware is not suitable for combined operation with steam.

- ▶ Cookware must be heat- and steam-resistant. Using cookware with rust spots may cause corrosion in the cooking compartment. Even the smallest spots of rust can cause corrosion.

- ▶ Do not use cookware with rust spots.

Hot water in the water tank may damage the steam system.

- ▶ Only fill the water tank with cold water.

If there is water on the cooking compartment floor when operating the appliance at temperatures above 120 °C, this will damage the enamel.

- ▶ Do not use the appliance if there is water on the cooking compartment floor.
- ▶ Wipe away any water on the cooking compartment floor before operation.

If descaling solution comes into contact with the control panel or other delicate surfaces, it will damage them.

- ▶ Remove descaling solution immediately with water. Cleaning the water tank in the dishwasher will damage it.
- ▶ Do not clean the water tank in the dishwasher.
- ▶ Clean the water tank with a soft cloth and standard washing-up liquid.

3 Environmental protection and saving energy

3.1 Disposing of packaging

The packaging materials are environmentally compatible and can be recycled.

- ▶ Sort the individual components by type and dispose of them separately.

3.2 Saving energy

If you follow these instructions, your appliance will use less power.

Only preheat the appliance if the recipe or the recommended settings tell you to do so.

- Not preheating the appliance can reduce the energy used by up to 20%.

Use dark-coloured, black-coated or enamelled baking tins.

- These types of baking tin absorb the heat particularly well.

Open the appliance door as little as possible during operation.

- This will maintain the temperature in the cooking compartment and eliminate the need for the appliance to reheat.

When baking multiple dishes, do so in succession or in parallel.

- The cooking compartment is heated after baking the first dish. This reduces the baking time for the second cake.

If the cooking time is relatively long, you can switch the appliance off 10 minutes before the cooking time ends.

- There will be enough residual heat to finish cooking the dish.

Remove any accessories that are not being used from the cooking compartment.

- Accessories that are not being used do not need to be heated.

Allow frozen food to defrost before cooking.

- This will save the energy that would otherwise be required to defrost it.

4 Familiarising yourself with your appliance

4.1 Control panel

You can use the control panel to configure all functions of your appliance and to obtain information about the operating status.

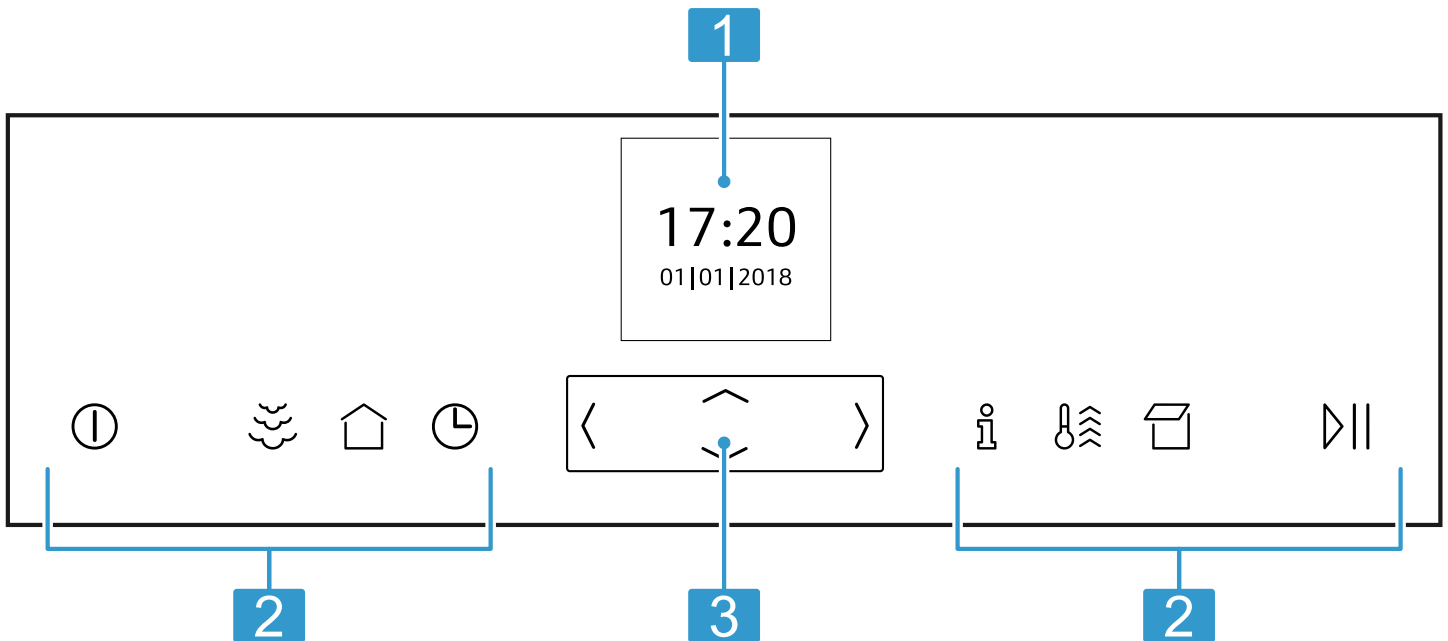

1 Display

2 Buttons

3 Control element

4.2 Buttons

The buttons are touch-sensitive areas. To select a function, press the corresponding button.

Symbol	Name	Use
ⓘ	On/off	Switch the appliance on or off
☁	Steam assistance	Switch on steam assistance
🏠	Main menu	Select operating modes and settings
🕒	Time-setting options/ childproof lock	<ul style="list-style-type: none"> Set the "timer", "cooking time" or "Ready at" time for delayed starts Activate or deactivate the "childproof lock"
ℹ️	Information	<ul style="list-style-type: none"> View additional information View the current temperature
🌡️	Rapid heat-up	<ul style="list-style-type: none"> Activate or deactivate the "Rapid heat-up" function Activate or deactivate the "PowerBoost" function
📦	Open control panel	Fill or empty the water tank
▶️	Start/stop	Start or pause the appliance

4.3 Control element

You can configure all the functions on your appliance using the control element. You can change the setting values that are displayed more brightly.





Press and hold a button to scroll through the setting values quickly. Release the button to stop scrolling quickly.

Button	Name	Use
<	Left	Navigate to the left on the display
>	Right	Navigate to the right on the display
^	Up	Navigate upwards on the display
v	Down	Navigate downwards on the display

4.4 Main menu











The main menu provides an overview of your appliance's functions.





Press the  button to open the main menu.

Function	Name	Use
	Heating functions	Select the required heating function and temperature for your food
	Steam programs	Cooking food with steam
	Settings	Individually adjust the appliance settings
	Descal	Descal the steam system
	EasyClean	Clean less stubborn dirt from the cooking compartment

4.5 Heating functions

Here you will find an overview of the heating functions. You will find recommendations on using the heating functions. For temperatures above 275 °C, the appliance reduces the temperature to approx. 275 °C after approx. 40 minutes.

Symbol	Heating function	Temperature	Use
	CircoTherm hot air	40 - 200 °C	Bake or roast on one or more levels. The fan distributes the heat from the ring-shaped heating element in the back wall evenly around the cooking compartment.
	Top/bottom heating	50 - 275 °C	Traditionally bake or roast on one level. This heating function is ideal for cakes with moist toppings. The heat is emitted evenly from above and below.
	Circo-roasting	50 - 250 °C	Roast poultry, whole fish or large pieces of meat. The grill element and the fan switch on and off alternately. The fan circulates the hot air around the food.
	Pizza setting	50 - 275 °C	Cook pizza or food that requires a lot of heat from below. The bottom heating element and the ring-shaped heating element in the back wall heat the cooking compartment.
	Bread-baking setting	180 - 240 °C	For baking bread, bread rolls and baked goods that require high temperatures.
	Full-surface grill	50 - 290 °C	For grilling thin items such as steaks, sausages or bread and for browning food. The entire area below the grill element becomes hot.
	Centre-area grill	50 - 290 °C	For grilling small amounts of steaks, sausages or bread and for browning food. The central area underneath the grill element becomes hot.
	Bottom heating	50 - 250 °C	For cooking in a bain marie and for baking food for extra time. Heat is emitted from below.
	Slow cooking	70 - 120 °C	For gentle, slow cooking of seared, tender pieces of meat in ovenware without a lid. Heat is emitted evenly from above and below at a low temperature.
	Dough proving	2 settings	For proving dough and culturing yoghurt. Dough will prove more quickly than at room temperature. The surface of the dough will not dry out.
	Keep warm	60 - 100 °C	For keeping cooked food warm.

Symbol	Heating function	Temperature	Use
	Top/bottom heating eco	50 - 275 °C	For gently cooking selected types of food. Heat is emitted from above and below. This heating function is most effective between 150 and 250 °C. This heating function is used to measure the energy consumption in the standard mode.
	CircoTherm eco	40 - 200 °C	For gently cooking selected types of food on one level without preheating. The fan distributes the heat from the ring-shaped heating element in the back wall around the cooking compartment. This heating function is most effective between 125 and 200 °C. This heating function is used to measure the energy consumption in air recirculation mode and determine the energy efficiency class.
	Reheat	80 - 180 °C	For gently reheating food or for crisping up baked goods.
	Dry appliance	Fixed setting	For drying the cooking compartment after cooking with steam.

4.6 Cooking compartment

The functions in the cooking compartment make your appliance easier to use.

Shelf supports

The rails in the cooking compartment enable you to place accessories at different heights.

→ "Accessories", Page 9

Your appliance has four shelf positions. The shelf positions are numbered from bottom to top.

You can remove the rails, e.g. for cleaning.

→ "Rails", Page 23

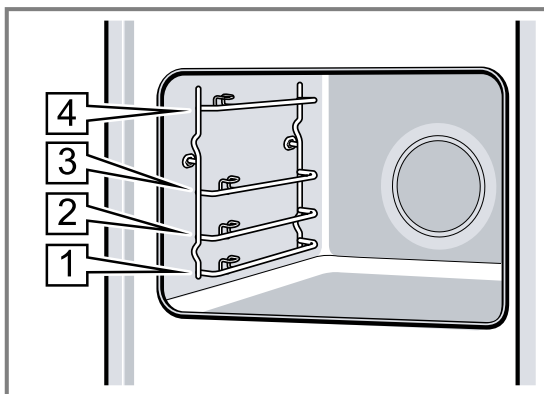

Self-cleaning surfaces

The back panel in the cooking compartment is self-cleaning. The self-cleaning surfaces are coated with a porous, matte ceramic layer and have a coarse surface. When the appliance is in operation, the self-cleaning surfaces absorb splashes from roasting or grilling and break them down.

If the self-cleaning surfaces no longer clean themselves adequately during operation, heat up the cooking compartment specifically to the right temperature.

→ "Cleaning self-cleaning surfaces in the cooking compartment", Page 21

Lighting

One or more oven lights illuminate the cooking compartment.

When you open the appliance door, the light in the cooking compartment switches on. If the appliance door remains open for longer than 15 minutes, the light switches off again.

For most operating modes, the lighting is switched on during operation. The lighting switches off again when the operation ends.

Cooling fan

The cooling fan switches on and off depending on the appliance's temperature. The hot air escapes above the door.

ATTENTION!

Do not cover the ventilation slot above the appliance door. The appliance overheats.

► Ensure that the ventilation slots are unobstructed.

To ensure that the appliance cools down more quickly after operation, the cooling fan continues to run for a certain period afterwards.

Appliance door

If you open the appliance door during operation, the operation stops. When you close the appliance door, the operation continues automatically.

Water tank

You need the water tank for the types of steam heating. The water tank is behind the control panel.
→ "Filling the water tank", Page 12

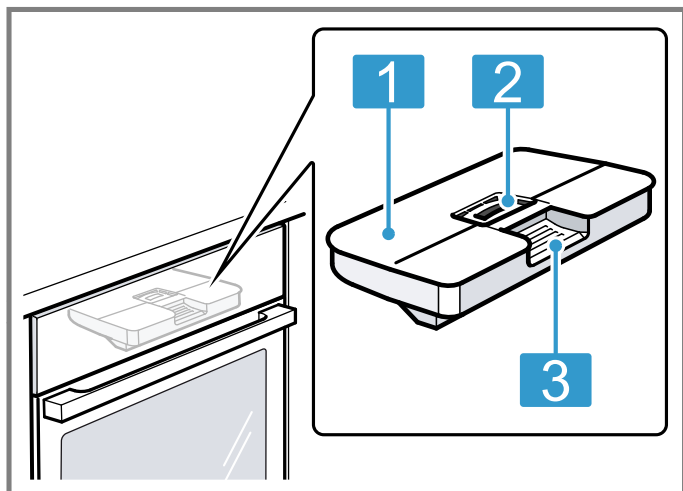

- | | |
|---|-----------------------------------|
| 1 | Tank cover |
| 2 | Opening for filling and emptying |
| 3 | Handle for removing and inserting |

5 Accessories

Use original accessories. These have been made especially for your appliance.

Note: Accessories may become deformed if they get hot. Deformation has no effect on function. As the accessory cools down, it will regain its original shape.

The accessories supplied may differ depending on the appliance model.

Accessories

Wire rack

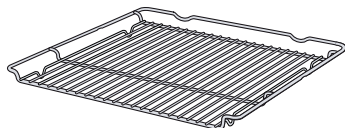

Use

- Cake tins
- Ovenproof dishes
- Cookware
- Meat, e.g. roasting joints or steak
- Frozen meals

Universal pan

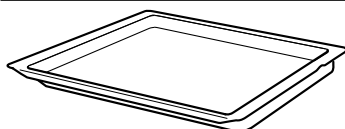

- Moist cakes
- Baked items
- Bread
- Large roasts
- Frozen meals
- Catch dripping liquids, e.g. fat when grilling food on the wire rack.

Baking tray

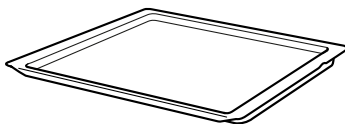

- Tray bakes
- Small baked items

5.1 Locking function

The locking function prevents the accessories from tilting when they are pulled out.

You can pull out the accessories approximately halfway without them tipping. The accessories must be inserted into the cooking compartment correctly for the tilt protection to work properly.

5.2 Sliding accessories into the cooking compartment

Always slide the accessory into the cooking compartment the right way round. This is the only way to ensure that accessories can be pulled out approximately halfway without tipping.

1. Turn the accessories so that the notch  is at the rear and is facing downwards.

en Before using for the first time

2. Insert the accessory between the two guide rods for a shelf position.

Wire rack Insert the wire rack with the open side facing the appliance door and the curved lip  facing downwards.

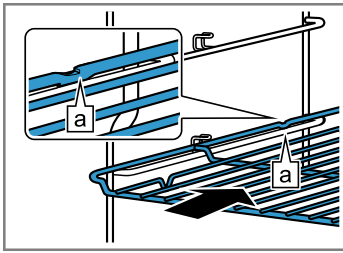

Baking tray E.g. universal pan or baking tray Slide the tray in with the sloping edge  towards the appliance door.

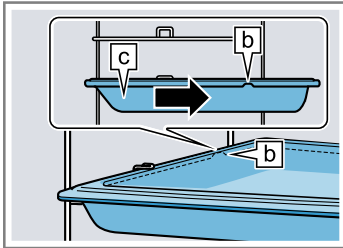

3. Push the accessory all the way in, making sure that it does not touch the appliance door.

Note: Take any accessories that you will not be using out of the cooking compartment while the appliance is in operation.

Combining accessories

You can combine the wire rack with the universal pan to catch any liquid that drips down.

1. Place the wire rack on the universal pan so that both spacers  are on the rear edge of the universal pan.
2. Insert the universal pan between the two guide rods for a shelf position. In so doing, the wire rack is on top of the upper guide rod.

Wire rack on universal pan

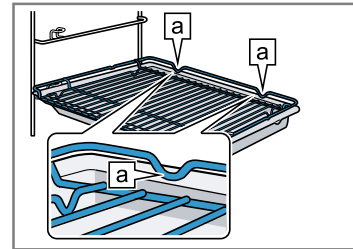

5.3 Other accessories

You can purchase other accessories from our after-sales service, specialist retailers or online. You will find a comprehensive range of products for your appliance in our brochures and online: www.neff-international.com

Accessories vary from one appliance to another. When purchasing accessories, always quote the exact product number (E no.) of your appliance. You can find out which accessories are available for your appliance in our online shop or from our after-sales service.

6 Before using for the first time

Configure the settings for initial start-up. Clean the appliance and accessories.

6.1 Before using for the first time

Before using the appliance for the first time, ask your water supplier about the hardness of your tap water. To ensure that the appliance can reliably remind you to descale it when required, you must set your water hardness range correctly.

ATTENTION!

If the wrong water hardness has been set, the appliance cannot remind you to descale it at the right time.

- ▶ Set the water hardness correctly.
- Using unsuitable liquids may damage the appliance.
- ▶ Do not use distilled water, highly chlorinated tap water (>40 mg/l) or other liquids.
 - ▶ Only use cold, fresh tap water, softened water or non-carbonated mineral water.

Malfunctions may occur when using filtered or demineralised water. The appliance may request that you top up the water tank even though it may be full, or operation with steam is cancelled after approx. two minutes.

- ▶ If required, mix filtered or demineralised water with the bottled non-carbonated mineral water with a ratio of one to one.

Tip: If you use mineral water, set the water hardness range to "very hard". If you use mineral water, you must only use non-carbonated mineral water.

Tip: If your tap water is very hard, we recommend that you use softened water. If you use only softened water, you can set your appliance to the "softened" water hardness range.

Setting	Water hardness in mmol/l	German hardness in °dH	French hardness °fH
0 (softened) ¹	-	-	-
1 (soft)	Up to 1.5	Up to 8.4	Up to 15
2 (moderately hard)	1.5-2.5	8.4-14	15-25

¹ Only set this if you will be using solely softened water.

² Also set for mineral water. Only use non-carbonated mineral water.

Setting	Water hardness in mmol/l	German hardness in °dH	French hardness °fH
3 (hard)	2.5-3.8	14-21.3	25-38
4 (very hard) ²	Above 3.8	Above 21.3	Above 38

¹ Only set this if you will be using solely softened water.
² Also set for mineral water. Only use non-carbonated mineral water.

6.2 Initial use

When the appliance is connected to the power supply for the first time or following a lengthy power failure, the settings that you will need to configure before you can use it will appear.

Note: You can change these settings at any time by going to the basic settings.

→ "Basic settings", Page 19

Setting the language

1. Connect the appliance to the power supply.
 - ✓ The first setting will appear after a few seconds.
2. Use the \vee button to navigate to the bottom row.
3. Use the \langle or \rangle button to select the language.
4. Use the \wedge button to navigate back to the top row.
5. Use the \rangle button to select the next setting.

Setting the time

1. Use the \vee button to navigate to the next row.
2. Use the \langle or \rangle button to select the current time.
3. Use the \wedge button to navigate back to the top row.
4. Use the \rangle button to select the next setting.

Setting the date

1. Use the \vee button to navigate to the next row.
2. Use the \langle or \rangle button to select the correct day.
3. Use the \wedge button to navigate back to the top row.
4. Use the \rangle button to select the next setting.
5. Use the \vee button to navigate to the next row.
6. Use the \langle or \rangle button to select the correct month.
7. Use the \wedge button to navigate back to the top row.
8. Use the \rangle button to select the next setting.
9. Use the \vee button to navigate to the next row.
10. Use the \langle or \rangle button to select the correct year.
11. Use the \wedge button to navigate back to the top row.
12. Use the \rangle button to select the next setting.

Setting the water hardness

1. Use the \vee button to navigate to the bottom row.
2. Use the \langle or \rangle button to select the water hardness range.
 - "Before using for the first time", Page 10
3. Use the \wedge button to navigate back to the top row.
4. Use the \rangle button to save your settings.
5. Open and close the appliance door once.

- ✓ The appliance will perform a self-test, after which it will be ready to use.
- ✓ Initial configuration is now complete.

6.3 Cleaning the appliance

Before using the appliance to cook food for the first time, you must clean the cooking compartment and accessories.

1. Remove the product information, accessories and any leftover packaging (e.g. polystyrene pellets) from the cooking compartment.
2. Wipe the smooth surfaces in the cooking compartment with a soft, damp cloth.
3. Press \odot to switch the appliance on.
 - "Switching on the appliance", Page 11
4. Fill the water tank.
 - "Filling the water tank", Page 12
5. Set the required heating function, temperature and steam assistance for the heat-up process and press \triangleright to start.
 - "Setting the type of heating and temperature", Page 12
 - "Steam-assisted cooking", Page 14

Heating up

Heating function	CircoTherm hot air ⌘ with steam assistance ⌘ , steam intensity "High"
Temperature	Maximum
Cooking time	1 hour

6. Keep the kitchen ventilated while the appliance is heating.
7. Press \odot to switch off the appliance after 1 hour.
 - "Switching off the appliance", Page 11
8. Allow the appliance to cool down.
9. Clean the smooth surfaces with soapy water and a dish cloth.
10. Empty the water tank and dry the cooking compartment.
 - "After every steam operation", Page 14
11. Thoroughly clean any accessories you used with soapy water and a dish cloth.

7 Basic operation

7.1 Switching on the appliance

- ▶ Press \odot to switch the appliance on.

Notes

- In the basic settings, you can specify whether the heating functions or the main menu should appear when you switch on the appliance.
 - "Basic settings", Page 19

- If you do not perform any actions on the appliance for an extended period, it will automatically switch itself off.

7.2 Switching off the appliance

- ▶ Press \odot to switch the appliance off.

Notes

- The residual heat indicator will appear on the display while the cooking compartment is still hot.
→ "Residual heat indicator", Page 12
- The cooling fan will continue to run until the cooking compartment has cooled down.
→ "Cooling fan", Page 8

7.3 Residual heat indicator

After you have switched off the appliance, the residual heat indicator will appear on the display.

Display	Meaning
-H-	Residual heat high (over 120 °C)
-h-	Residual heat low (between 60 and 120 °C)

7.4 Setting the type of heating and temperature

1. Press to switch the appliance on.
- ✓ The heating functions will then be displayed.
2. Use the < or > button to select the required heating function.
3. Use the ~ button to navigate to the next row.
4. Use the < or > button to select the required temperature or setting.
5. Press to start.
- ✓ The cooking time will appear on the display.
- ✓ The heat-up indicator bar visualises the rising temperature.
6. When the food is ready, press to switch the appliance off.

7.5 Changing the temperature

You can also change the temperature once you have started the appliance.

1. Use the ^ or v button to select the temperature row.

2. Use the < or > button to select the required temperature.
- ✓ The temperature will now be changed.

7.6 Changing the type of heating

If you switch to a different heating function, the appliance will reset all the settings.

1. Press to pause operation.
2. Use the < or > button to select the required heating function.
3. Use the ~ button to navigate to the next row.
4. Use the < or > button to select the required temperature.
5. Press to start.

7.7 Pausing operation

1. Press .
2. Press again to resume operation.

7.8 Cancelling operation

Note: Some functions, e.g. cleaning functions, cannot be cancelled.

- ▶ Press and hold the button until the function that is currently in progress is cancelled.
- ✓ Operation will stop and all the settings will be reset.
- ✓ The cooling fan will continue to run until the cooking compartment has cooled down.

7.9 Viewing the current temperature

You can view the current temperature while the appliance is heating up.

- ▶ Press .
- ✓ The temperature will be displayed for a few seconds.

7.10 Displaying information

Requirement: The button must be lit.

- ▶ Press .
- ✓ The information will be displayed for a few seconds.

8 Steam

Food can be cooked particularly gently using steam. You can use the special types of steam heating, or use steam assistance with certain types of heating.

 WARNING – Risk of scalding!

Hot steam may escape when you open the appliance door. Steam may not be visible, depending on the temperature.

- ▶ Open the appliance door carefully.
- ▶ Keep children at a safe distance.

8.1 Filling the water tank **WARNING – Risk of fire!**

Due to the hot surfaces, vapours from flammable liquids may catch fire in the cooking compartment (ex-

plosion). The appliance door may spring open. Hot steam and jets of flame may escape.

- ▶ Do not pour flammable liquids (e.g. alcoholic drinks) into the water tank.
- ▶ Only fill the water tank with water or with the descaling solution we have recommended.

 WARNING – Risk of burns!

The water tank may heat up while the appliance is in operation.

- ▶ Wait until the water tank has cooled down from the previous operation.
- ▶ Remove the water tank from the tank recess.

Requirement: The water hardness must be set correctly.

→ "Before using for the first time", Page 10

1. Press .
- ✓ The control panel will pop out automatically.
2. Pull the control panel towards you with both hands and then push it upwards until it clicks into place ①.
3. Lift the water tank and remove it from the water tank recess ②.

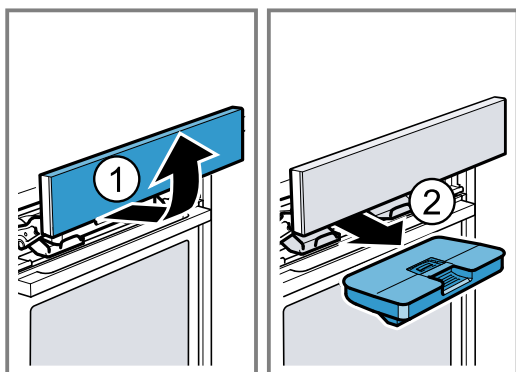

4. Press down on the water tank lid along the seal to prevent water from leaking out of the water tank.
5. Fill the water tank with water up to the "max"  mark.

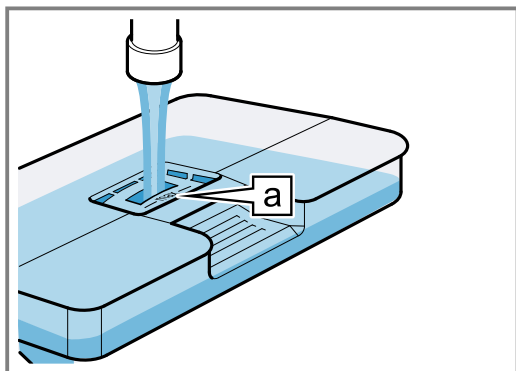

6. Slide the full water tank back into the recess ①. When doing so, make sure that the water tank clicks into place in the retainers .

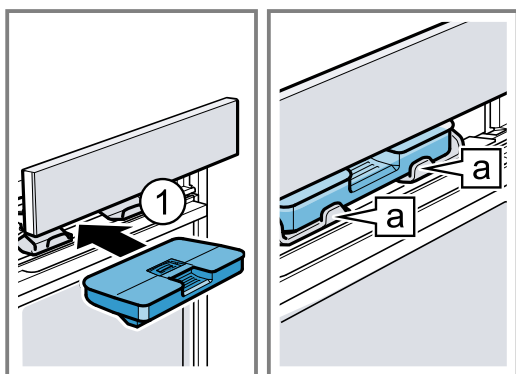

7. Slowly slide the control panel downwards and then push it away from you until it is closed completely.

8.2 Refilling the water tank

When "Fill water tank" appears on the display, you must refill the water tank.

Notes

- Dough proving and Reheat functions: If you do not refill the water tank, the appliance will stop. Refill the water tank.

- Steam-assisted heating: If you do not refill the water tank, the appliance will continue to heat but without injecting steam into the cooking compartment.

1. Open the control panel.
2. Remove and refill the water tank.
3. Insert the full water tank and close the control panel.

8.3 Steam heating functions

Your appliance has several steam heating functions:











- Dough proving 
- Reheat 

Dough proving

Yeast dough will prove considerably more quickly using the "Dough proving" heating function than at room temperature, and it will not dry out.

Configuring the Dough proving heating function











Requirement: The cooking compartment must have cooled down completely.

1. Fill the water tank.
→ "Filling the water tank", Page 12
2. Press  to switch the appliance on.
3. Use the  or  button to set "Dough proving" .
4. Use the  button to navigate to the next row.
5. If necessary, use the  button to set setting 2.
6. Use the  button to navigate to the next row.
7. Use the  or  button to select the required proving time.
8. Press  to start the dough proving process.
→ "Pausing operation", Page 12
→ "Cancelling operation", Page 12
- ✓ If the water tank runs dry during the dough proving process, dough proving will be paused.
→ "Refilling the water tank", Page 13
- ✓ Once the duration has elapsed, an audible signal will sound and the appliance will stop heating.
→ "Switching off the appliance", Page 11
9. Press any button to end the audible signal.
10. Empty the water tank and dry the cooking compartment.
→ "After every steam operation", Page 14

Reheat

The "Reheat" function is used to warm up food that has already been cooked, or bread and pastries from the day before, without affecting its quality.

Configuring the Reheat heating function

1. Fill the water tank.
→ "Filling the water tank", Page 12
2. Press  to switch the appliance on.
3. Use the  or  button to set "Reheat" .
4. Use the  button to navigate to the next row.
5. Use the  or  button to select the required temperature.
6. Use the  button to navigate to the next row.
7. Use the  or  button to select the required reheating time.
8. Press  to start the reheating process.
→ "Pausing operation", Page 12
→ "Cancelling operation", Page 12
- ✓ If the water tank runs dry during the reheating process, reheating will be paused.
→ "Refilling the water tank", Page 13





- ✓ Once the duration has elapsed, an audible signal will sound and the appliance will stop heating.
→ "Switching off the appliance", Page 11
- 9. Press any button to end the audible signal.
- 10. Empty the water tank and dry the cooking compartment.
→ "After every steam operation", Page 14

8.4 Steam-assisted cooking







When you cook with steam assistance, the appliance introduces steam into the cooking compartment at various intervals. This gives your food a crispy crust and a shiny surface. Meat stays juicy, tender and only undergoes a minimum reduction in volume.

Heating functions compatible with steam assistance

You can switch on steam assistance for the following heating functions:

- "CircoTherm hot air" 
- "Top/bottom heating" 
- "Circo-roasting" 
- "Bread-baking setting" 
- "Keep warm" 

Switching on steam assistance

1. Fill the water tank.
→ "Filling the water tank", Page 12
2. Press  to switch the appliance on.
3. Set a suitable heating function.
→ "Heating functions compatible with steam assistance", Page 14
4. Set the required temperature.
5. Use the  button to switch on steam assistance.
6. Use the  button to navigate to the row featuring the steam intensity .
7. Use the  or  button to select the required steam intensity:
 - Low
 - Medium
 - High
8. Press  to start steam-assisted heating.
 - ✓ If the water tank runs dry during steam-assisted heating, "Fill water tank" will appear on the display. The appliance will continue to heat but without injecting steam into the cooking compartment.
→ "Refilling the water tank", Page 13

Cancelling steam-assisted cooking

- ▶ Press .
- ✓ The appliance will continue to heat but without injecting steam into the cooking compartment.

Ending steam-assisted heating

1. Press  to switch the appliance off.
2. Empty the water tank and dry the cooking compartment.
→ "After every steam operation", Page 14

8.5 After every steam operation

The remaining water is pumped back into the water tank after every operation with steam. Then empty and dry the water tank and the cooking compartment.

Emptying the water tank

WARNING – Risk of burns!

The water tank may heat up while the appliance is in operation.

- ▶ Wait until the water tank has cooled down from the previous operation.
- ▶ Remove the water tank from the tank recess.

ATTENTION!

Drying the water tank in the hot cooking compartment leads to damage to the water tank.

- ▶ Do not dry the water tank in the hot cooking compartment.

Cleaning the water tank in the dishwasher will damage it.

- ▶ Do not clean the water tank in the dishwasher.
- ▶ Clean the water tank with a soft cloth and standard washing-up liquid.

Note: Once the appliance has been switched off, the  button remains lit for a little longer to remind you to empty the water tank.

1. Use  to open the control panel.
2. Remove the water tank.
3. Carefully remove the lid of the water tank.
4. Empty the water tank, clean it with detergent and then rinse it thoroughly with clean water.
5. Dry all parts with a soft cloth.
6. Rub the seal on the lid until dry.
7. Leave the water tank to dry with the lid open.
8. Place the lid on the water tank and push down on it.
9. Insert the water tank and close the control panel.

Drying the cooking compartment

To dry the cooking compartment, you can either use the "Dry appliance" function or you can dry the cooking compartment manually.

Drying the cooking compartment with the Dry appliance function

The Dry appliance function heats up the cooking compartment so that the moisture in the cooking compartment evaporates. You will then need to open the appliance door to allow the steam to escape.

WARNING – Risk of burns!

The appliance becomes hot during operation.

- ▶ Allow the appliance to cool down before cleaning.







ATTENTION!

If there is water on the cooking compartment floor when operating the appliance at temperatures above 120 °C, this will damage the enamel.

- ▶ Do not use the appliance if there is water on the cooking compartment floor.
- ▶ Wipe away any water on the cooking compartment floor before operation.

Requirement: The cooking compartment must have cooled down.

1. Remove any food remnants from the cooking compartment.

2. Dry the cooking compartment with a sponge.
3. Press  to switch the appliance on.
4. Use the  or  button to set "Dry appliance" .
 - ✓ The temperature and drying time will appear on the display. These cannot be changed.
5. Press  to start drying the appliance.
 - ✓ Once the duration has elapsed, an audible signal will sound and the appliance will stop heating.
6. Press  to switch the appliance off.
7. Remove limescale marks with a cloth soaked in vinegar, then wipe with clean water and dry with a soft cloth.
8. Leave the appliance door open for 1-2 minutes so that the cooking compartment dries completely.

Drying the cooking compartment manually

WARNING – Risk of burns!

The appliance becomes hot during operation.

- ▶ Allow the appliance to cool down before cleaning.

ATTENTION!

If there is water on the cooking compartment floor when operating the appliance at temperatures above 120 °C, this will damage the enamel.

- ▶ Do not use the appliance if there is water on the cooking compartment floor.
- ▶ Wipe away any water on the cooking compartment floor before operation.

Requirement: The cooking compartment must have cooled down.



1. Remove any food remnants from the cooking compartment.
2. Dry the cooking compartment with a sponge.
3. Leave the cooking compartment to dry with the appliance door open for 1 hour.
4. Remove limescale marks with a cloth soaked in vinegar, then wipe with clean water and dry with a soft cloth.
5. Leave the appliance door open for 1-2 minutes so that the cooking compartment dries completely.

9 Time-setting options

Your appliance has different time-setting options, with which you can control its operation.

9.1 Overview of the time-setting options







When you are setting a time, the time values will increase by greater increments as you scroll through the higher values. The cooking time, for example, can be set in 1-minute increments up to 1 hour, and then in 5-minute increments thereafter.

Time-setting option	Use
Timer 	When you set a time on the timer, the timer will run independently of the appliance and will not intervene in its operation. The timer does not affect the appliance.
Cooking time 	Once the cooking time has elapsed, the appliance automatically stops heating.
Ready at 	Along with the cooking time (duration), you can set the time at which you want cooking to end. The appliance will start up automatically so that it finishes cooking at the required time.

9.2 Timer



You can set the timer regardless of whether the appliance is on or off.

Setting the timer



1. Press .
2. Once the appliance is switched on, use the  button to select "Timer" .
3. Use the  or  button to select the timer duration.
4. Press  to start the timer.

- ✓  will appear on the display. The timer duration will then count down.
- ✓ Once the timer duration has elapsed, an audible signal will sound.
5. Press any button to end the audible signal.

Changing the timer

1. Press .
2. Use the  or  button to change the timer duration.
- ✓ The setting will then be applied.

Cancelling the timer



1. Press .
2. Use the  button to set a timer duration of "00:00".
- ✓ This cancels the current timer duration.



9.3 Cooking time

Once the set cooking time has elapsed, the appliance switches off automatically. You can only use the cooking time in conjunction with a heating function.



Setting the cooking time

1. Set a heating function and a temperature.
2. Press .
3. Select the default value.



Button	Default value
	10 minutes
	30 minutes

4. Use the  or  button to select the required cooking time.
5. Once the cooking time has been set, press  to start.
 - ✓ The cooking time will appear on the display. The cooking time will count down.
 - ✓ Once the cooking time has elapsed, an audible signal will sound.
6. Press any button to end the audible signal.

Changing the cooking time

1. Press .
2. Use the  or  button to change the cooking time.
- ✓ The setting will then be applied.

Cancelling the cooking time

1. Press .
2. Use the  button to set a cooking time of "00:00".
- ✓ This cancels the current cooking time.
3. To continue without setting a cooking time, press .







9.4 Delayed start/"Ready at" time

With this function, the appliance automatically switches itself on, and then switches itself off at the preselected end time. To enable it to do this, you set the cooking time (duration) and specify when you want your food to be ready. You can only use the delayed start function in conjunction with a heating function.





Setting the Ready at time for delayed starts

Notes



- Do not leave food that spoils easily in the cooking compartment for too long.
 - You cannot use the delayed start function with every heating function.
1. Place the food into the cooking compartment and close the appliance door.

2. Set a heating function and a temperature.
3. Press .
4. Use the  or  button to select the required cooking time.
5. Use the  button to navigate to "Ready at" .
- ✓ The time at which your food will be ready will appear on the display.
6. Use the  button to select the required end time.
7. Press  to confirm the delayed start.
- ✓ The appliance will start at the appropriate time.
- ✓ Once the cooking time has elapsed, an audible signal will sound.
8. Press any button to end the audible signal.

Changing the Ready at time for delayed starts

1. Press .
2. Use the  button to select "Ready at" .
3. Use the  or  button to change the end time.
- ✓ The setting will then be applied.

Cancelling the Ready at time for delayed starts

1. Press .
2. Use the  button to reset the end time.
- ✓ The end time corresponds to the current time plus the set cooking time.
- ✓ The appliance will start heating using the set cooking time.

10 Steam programs

The steam programs help you to use your appliance to cook various dishes by selecting the optimal settings automatically.

10.1 Cookware

The cooking result depends on the composition of the meat and the size of cookware.

You should therefore use heat-resistant cookware that is suitable for temperatures up to 300 °C. Glass or glass ceramic cookware is best. The joint should cover approx. two thirds of the cookware base.

Cookware made from the following material is not suitable:

- Bright, shiny aluminium
- Unglazed clay
- Plastic or plastic handles

10.2 Overview of the steam programs

You can choose from the following steam programs:

- White bread, without a tin
- Wheat bread, wheat bread with rye, without a tin
- Wheat bread, wheat bread with rye, in a loaf tin
- Rye bread with wheat and yeast in a loaf tin
- Flatbread
- Plaited loaf, unfilled/plaited ring
- Sponge cake
- Joint of pork with crackling
- Boned pork neck joint
- Smoked pork, boned/rolled joint
- Fillet of beef, fresh, medium
- Sirloin, fresh, medium

- Sirloin, fresh, rare
- Chicken, whole, fresh
- Chicken pieces, fresh
- Duck, goose, unstuffed, fresh
- Fish fillet
- Whole fish

10.3 Preparing food for the steam program









Note: Use fresh and, ideally, chilled food. Use frozen food straight from the freezer.

- ▶ Weigh the food.
Some steam programs need to know the weight of the food in order to configure the steam program's settings accordingly.

10.4 Configuring the steam program

WARNING – Risk of scalding!

Hot steam may escape when you open the appliance door. Steam may not be visible, depending on the temperature.

- ▶ Open the appliance door carefully.
 - ▶ Keep children at a safe distance.
1. Fill the water tank and insert it.
 2. Press  to switch the appliance on.
 3. Press .
 4. Use the  or  button to select "Steam programs" .
 5. Use the  button to navigate to the next row.
 6. Use the  or  button to select the required steam program.
 7. Use the  button to navigate to the next row.

8. Use the < or > button to select the appropriate weight.
9. Use the ~ button to navigate to the next row.
 - ✓ The recommended shelf position and cookware will be displayed.
10. Press ▶|| to start the steam program.
 - ✓ The calculated cooking time will be displayed. For some steam programs, the cooking time may change during the first few minutes, as the heating-up time depends on the temperature of the food and the water, amongst other things.
 - ✓ Once the cooking time has elapsed, an audible signal will sound and the appliance will stop heating.

- 11. Note:** Some steam programs allow you to extend the cooking time.
→ "Extending the cooking time", Page 17
- If you are happy with the cooking result, use the ^ button to select "End".

10.5 Extending the cooking time

1. Use the ~ button to select "Extend cooking time".
2. Use the < or > button to change the settings, if required.
3. Press ▶|| to start the appliance again for the extra cooking time.

11 Childproof lock

You can secure your appliance to prevent children from accidentally switching it on or changing the settings.

11.1 Locks

Your appliance has two different locks:

Lock	Activate/deactivate
Automatic childproof lock	Via the Settings menu ⚙️
One-time childproof lock	Using the ⏸ button

11.2 Activating the automatic childproof lock

The automatic childproof lock disables the control panel to prevent children from accidentally switching on the appliance. To switch on the appliance, interrupt the automatic childproof lock. Once the appliance has finished cooking, it automatically disables the control panel.

Note: When you activate the automatic childproof lock, the appliance will immediately disable the control panel. The ⏸ and ⏹ buttons will not be disabled.

Requirement: The appliance must be switched on.

1. Press ⏹.
2. Use the < or > button to select "Settings" ⚙️.
3. Use the ~ button to navigate to the next row.
4. Use the < or > button to select "Automatic childproof lock".
5. Use the ~ button to select the required settings.
6. Use the > button to set the lock to "Activated".
7. Press ⏹.
8. Use the ~ button to save your settings.
 - ✓ When you switch off the appliance, 🔒 will appear on the display.

11.3 Interrupting the automatic childproof lock

1. Press and hold the ⏸ button until "Childproof lock deactivated" appears on the display.

2. Press ⏹ to switch the appliance on and then start it up.

11.4 Deactivating the automatic childproof lock

1. Press and hold the ⏸ button until "Childproof lock deactivated" appears on the display.
2. Press ⏹ to switch the appliance on.
3. Press ⏹.
4. Use the < or > button to select "Settings" ⚙️.
5. Use the ~ button to navigate to the next row.
6. Use the < or > button to select "Automatic childproof lock".
7. Use the ~ button to select the required settings.
8. Use the < button to set the lock to "Deactivated".
9. Press ⏹.
10. Use the ~ button to save your settings.

11.5 Activating the one-time childproof lock

The one-time childproof lock disables the control panel to prevent children from accidentally switching on the appliance. To switch on the appliance, deactivate the one-time childproof lock. After you have switched off the appliance, the control panel will no longer be disabled.

Note: When you activate the automatic childproof lock, the appliance will immediately disable the control panel. The ⏸ and ⏹ buttons will not be disabled.

- ▶ Press and hold the ⏸ button until "Childproof lock activated" appears on the display.



11.6 Deactivating the one-time childproof lock

- ▶ Press and hold the ⏸ button until "Childproof lock deactivated" appears on the display.







12 Rapid heat-up

You can use the "Rapid heat-up" and "PowerBoost" functions to reduce the heat-up time. Whether the appliance is preheated with the "Rapid heat-up" function or the "PowerBoost" function depends on the heating function that has been set.

12.1 Rapid heat-up and PowerBoost

Function	Heating function	Food in the cooking compartment
Rapid heat-up	Top/bottom heating 	After preheating
PowerBoost	<ul style="list-style-type: none"> ■ CircoTherm hot air  ■ Bread-baking setting  	Before heating up Only cook on one level







12.2 Activating the "Rapid heat-up" function

1. Set Top/bottom heating  and a temperature of at least 100 °C.
2. Press  to start.
 - ✓ The  button will be lit.
3. Use the  button to activate the "Rapid heat-up" function.
 - ✓  will appear on the display.
 - ✓ Once the set temperature has been reached, the "Rapid heat-up" function will switch itself off automatically and an audible signal will sound.  will go out on the display.
4. Place the food in the cooking compartment.

12.3 Deactivating the "Rapid heat-up" function

- ▶ Use the  button to deactivate the "Rapid heat-up" function early.

12.4 Activating the "PowerBoost" function

1. Place the food on a single level in the cooking compartment.
2. Set CircoTherm hot air  or the Bread-baking setting  and a temperature of at least 100 °C.
3. Press  to start.
 - ✓ The  button will be lit.
4. Press the  button to activate the "PowerBoost" function.
 - ✓  will appear on the display.
 - ✓ Once the set temperature has been reached, the "PowerBoost" function will switch itself off automatically and an audible signal will sound.  will go out on the display.

12.5 Deactivating the "PowerBoost" function

- ▶ Use the  button to deactivate the "PowerBoost" function early.

13 Sabbath mode

You can set a cooking time of up to 74 hours using Sabbath mode. You can use top/bottom heating to keep food warm between 85 °C and 140 °C during this time without having to switch the appliance on or off.



13.1 Starting Sabbath mode









Notes

- If you open the appliance door during operation, the appliance stops heating. When you close the appliance door, the appliance continues to heat again.
- Once you have started the operation, you cannot change any settings or pause operation.

Requirement: Sabbath mode must be activated in "Favourites" in the basic settings.

→ "Basic settings", Page 19

1. Press  to switch the appliance on.
2. Use  or  to select "Sabbath mode".

3. Use  to navigate to the next row.
4. Use  or  to select the temperature.
5. Use  to navigate to the next row.
6. Use  or  to select the cooking time.
7. Press  to start Sabbath mode.
 - ✓ The cooking time appears on the display. The cooking time counts down.
8. Once the cooking time has elapsed, an audible signal sounds. A note appears on the display confirming that the operation has finished. The appliance stops heating up and responds again as usual outside of Sabbath mode.
 - Press  to switch the appliance off. The appliance automatically switches off after approx. 10 to 20 minutes.

13.2 Cancelling Sabbath mode

- ▶ Press  to cancel Sabbath mode.

14 Basic settings

You can configure the appliance to meet your needs.

14.1 Overview of the basic settings

Here you can find an overview of the basic settings and factory settings. The basic settings depend on the features of your appliance.

Basic setting	Selection
Language	See selection on the appliance
Time	00:00 - 23:59
Date	Day, month and year
Water hardness → "Before using for the first time", Page 10	<ul style="list-style-type: none"> ■ 0 (softened) ■ 1 (soft) ■ 2 (moderately hard) ■ 3 (hard) ■ 4 (very hard)
Favourites → "Changing your favourites", Page 19	Set the heating functions that you want to appear in the heating functions menu
Audible signal duration	<ul style="list-style-type: none"> ■ Short ■ Medium ■ Long
Button tone	<ul style="list-style-type: none"> ■ Off (except for ) ■ On
Display brightness	5 settings
Clock display	<ul style="list-style-type: none"> ■ Digital ■ Off
Lighting	<ul style="list-style-type: none"> ■ On during operation ■ Off during operation
Automatic childproof lock	<ul style="list-style-type: none"> ■ Deactivated ■ Activated
Operation after switch-on	<ul style="list-style-type: none"> ■ Main menu ■ Types of heating ■ Steam programs
Night-time dimming	<ul style="list-style-type: none"> ■ Switched off ■ On (display dimmed between 10 p.m. and 5.59 a.m.)
Brand logo	<ul style="list-style-type: none"> ■ Indicators/symbols ■ Do not display
Fan run-on time	<ul style="list-style-type: none"> ■ Recommended ■ Minimum















¹ Depending on the appliance specifications

Basic setting	Selection
Pull-out rail system ¹	<ul style="list-style-type: none"> ■ No (rack or single set of pull-out rails fitted) ■ Yes (two or three sets of pull-out rails retrofitted)

Factory settings Load

¹ Depending on the appliance specifications

14.2 Changing basic settings



1. Press  to switch the appliance on.
2. Press .
3. Use the  or  button to select "Settings" .
4. Use the  button to navigate to the next row.
5. Use the  or  button to select a setting.
6. Use the  button to navigate to the next row.
7. Use the  or  button to change the setting.
8. Press .
9. To save your settings, use the  button to select "Save".
 - To discard your settings, use the  button to select "Discard".















14.3 Changing your favourites

In Favourites, you can set the heating functions that you want to appear in the heating functions menu.



Note:

Some heating functions cannot be deactivated:

- CircoTherm hot air 
- Circo-roasting 
- Full-surface grill 

1. Press  to switch the appliance on.
2. Press .
3. Use the  or  button to select "Settings" .
4. Use the  button to navigate to the next row.
5. Use the  or  button to select "Favourites".
6. Use the  button to navigate to the next row.
7. Use the  or  button to select the required heating function.
8. Use the  button to navigate to the next row.
9. Use the  or  button to select a setting.

Setting	Display in the heating functions menu?
Activated	Yes
Deactivated	No

10. Press .
11. To save your settings, use the  button to select "Save".
 - To discard your settings, use the  button to select "Discard".

15 Cleaning and servicing

To keep your appliance working efficiently for a long time, it is important to clean and maintain it carefully.

15.1 Cleaning products

In order to avoid damaging the various oven surfaces on the appliance, do not use unsuitable cleaning products.

⚠ WARNING – Risk of electric shock!

An ingress of moisture can cause an electric shock.

- ▶ Do not use steam- or high-pressure cleaners to clean the appliance.

ATTENTION!

Unsuitable cleaning products may damage the surfaces of the appliance.

- ▶ Do not use harsh or abrasive cleaning products.

- ▶ Do not use cleaning products with a high alcohol content.
- ▶ Do not use hard scouring pads or cleaning sponges.
- ▶ Do not use any special cleaners for cleaning the appliance while it is hot.

Using oven cleaner in a hot cooking compartment damages the enamel.

- ▶ Never use oven cleaner in the cooking compartment when it is still warm.
- ▶ Remove all food remnants from the cooking compartment and the appliance door before you next heat up the appliance.

New sponge cloths contain residues from production.

- ▶ Wash new sponge cloths thoroughly before use.

Suitable cleaning agents

Only use cleaning agents that are suitable for the different surfaces on your appliance.

Follow the instructions on cleaning the appliance.

→ "Cleaning the appliance", Page 21

Appliance front

Surface	Suitable cleaning agents	Information
Stainless steel	<ul style="list-style-type: none"> ▪ Hot soapy water ▪ Special stainless steel cleaning products suitable for hot surfaces 	To prevent corrosion, remove any limescale, grease, starch or albumin (e.g. egg white) stains on stainless steel fronts immediately. Apply a thin layer of the stainless steel cleaning product with a soft cloth.
Plastic or painted surfaces E.g. control panel	<ul style="list-style-type: none"> ▪ Hot soapy water 	Do not use glass cleaner or a glass scraper. To avoid permanent stains, remove any descaling agent that gets onto the surface immediately.

Appliance door

Area	Suitable cleaning agents	Information
Door panels	<ul style="list-style-type: none"> ▪ Hot soapy water 	Do not use a glass scraper or a stainless steel wool. Tip: Remove the door panels in order to clean them thoroughly. → "Appliance door", Page 24
Door cover	<ul style="list-style-type: none"> ▪ Made of stainless steel: Stainless steel cleaner ▪ Made of plastic: Hot soapy water 	Do not use glass cleaner or a glass scraper. Do not use stainless steel care products. Tip: Remove the door cover for thorough cleaning. → "Appliance door", Page 24
Stainless steel interior door frame	Stainless steel cleaner	Discolouration can be removed using stainless steel cleaner. Do not use stainless steel care products.
Door handle	<ul style="list-style-type: none"> ▪ Hot soapy water 	To avoid permanent stains, remove any descaling agent that gets onto the surface immediately.
Door seal	<ul style="list-style-type: none"> ▪ Hot soapy water 	Do not remove or scrub.

Cooking compartment

Area	Suitable cleaning agents	Information
Enamel surfaces	<ul style="list-style-type: none"> ■ Hot soapy water ■ Vinegar water ■ Oven cleaner 	Soak any heavily soiled areas and use a brush or steel wool. Leave the appliance door open to dry the cooking compartment after cleaning it. <p>Notes</p> <ul style="list-style-type: none"> ■ Enamel burns at very high temperatures, causing minor discoloration. The functionality of your appliance is not affected by this. ■ The edges of thin trays cannot be completely enamelled and may be rough. This does not impair corrosion protection. ■ Food residues will leave a white coating on the enamel surfaces. The coating does not pose a health risk. The functionality of your appliance is not affected by this. You can remove residues with lemon juice.
Self-cleaning surfaces	-	Follow the instructions for self-cleaning surfaces. → "Cleaning self-cleaning surfaces in the cooking compartment", Page 21
Glass cover for the oven light	<ul style="list-style-type: none"> ■ Hot soapy water 	Use oven cleaner to remove very heavy soiling.
Rails	<ul style="list-style-type: none"> ■ Hot soapy water 	Soak any heavily soiled areas and use a brush or steel wool. <p>Note: To clean thoroughly, detach the rails. → "Rails", Page 23</p>
Accessories	<ul style="list-style-type: none"> ■ Hot soapy water ■ Oven cleaner 	Soak any heavily soiled areas and use a brush or steel wool. Enamelled accessories are dishwasher-safe.
Water tank	<ul style="list-style-type: none"> ■ Hot soapy water 	To remove residual detergent after cleaning, rinse thoroughly with clean water. To dry the water tank after cleaning, leave the water tank to dry with the lid open. Dry the seal on the lid. Do not clean in the dishwasher.

15.2 Cleaning the appliance

In order to avoid damaging the appliance, you must clean your appliance only as specified, and with suitable cleaning products.

⚠ WARNING – Risk of burns!

The appliance and its parts that can be touched become hot during use.

- ▶ Caution should be exercised here in order to avoid touching heating elements.
- ▶ Young children under 8 years of age must be kept away from the appliance.

⚠ WARNING – Risk of fire!

Loose food remnants, fat and meat juices may catch fire.



- ▶ Before using the appliance, remove the worst of the food residues and remnants from the cooking compartment, heating elements and accessories.

Requirement: Read the information on cleaning products.

→ "Cleaning products", Page 20

1. Clean the appliance using hot soapy water and a dish cloth.
 - For some surfaces, you can use alternative cleaning agents.
 → "Suitable cleaning agents", Page 20
2. Dry with a soft cloth.

15.3 Checking the cooking compartment seal after cleaning

- ▶ If the cooking compartment seal is on the left or right of the spacer , slide the cooking compartment seal inwards until it is beside the spacer .

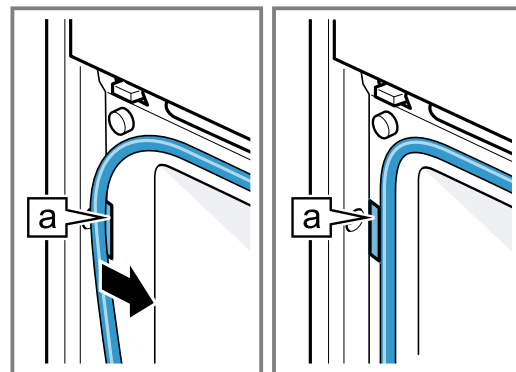

15.4 Cleaning self-cleaning surfaces in the cooking compartment

The back panel in the cooking compartment is self-cleaning. The self-cleaning surfaces are coated with a porous, matte ceramic layer and have a coarse surface. When the appliance is in operation, the self-cleaning surfaces absorb splashes from baking, roasting or grilling and break them down. If the self-cleaning sur-

faces no longer clean themselves adequately during operation, heat up the cooking compartment specifically to the right temperature.

ATTENTION!

If you do not clean the self-cleaning surfaces regularly, they may become damaged.

- ▶ If dark stains are visible on the self-cleaning surfaces, heat up the cooking compartment.
- ▶ Do not use oven cleaner or abrasive cleaning aids. If oven cleaner accidentally comes into contact with the self-cleaning surfaces, dab it off immediately using water and a sponge cloth. Do not rub.

1. Remove accessories and cookware from the cooking compartment.
2. Detach the shelf supports and remove them from the cooking compartment.
→ "Rails", Page 23
3. Remove coarse dirt using soapy water and a soft cloth:
 - From the smooth enamel surfaces

- From the inside of the appliance door
 - From the glass cover on the oven light
This prevents stains that cannot be removed.
4. Remove any objects from the cooking compartment. The cooking compartment must be empty.
 5. Set the Bread-baking setting.
 6. Set the maximum temperature.
 7. Start the operation.
 8. Switch off the appliance after one hour.
 9. Once the appliance has cooled down, wipe the cooking compartment with a damp cloth.
Note: Marks may appear on the self-cleaning surfaces. Residues of sugar and egg white in the food are not removed and stick to the surfaces. Red stains are residues from salty food – they are not rust. The stains are not hazardous to health. These marks do not impair the cleaning ability of the self-cleaning surfaces.
 10. Attach the shelf supports.
→ "Rails", Page 23

16 Cleaning function

You can use the cleaning function to clean the appliance.

16.1 EasyClean cleaning aid

You can use the "EasyClean" cleaning aid to clean light soiling from the cooking compartment between full cleans. The "EasyClean" cleaning aid soaks dirt by evaporating soapy water. It is then easier to remove the dirt.

Setting the EasyClean cleaning aid

⚠ WARNING – Risk of scalding!

If there is water in the cooking compartment when it is hot, this may create hot steam.

- ▶ Never pour water into the cooking compartment when the cooking compartment is hot.

Requirements

- You can only start the cleaning aid once the cooking compartment is cold (room temperature) and the appliance door is closed.
- Do not open the appliance door while the appliance is in operation, as this will abort the cleaning aid.
- To remove particularly stubborn dirt, leave the soapy water to work for a while before starting the cleaning aid.
- To remove particularly stubborn dirt, rub washing-up liquid onto dirty areas on the smooth surfaces before starting the cleaning aid.



1. Remove any accessories from the cooking compartment.



2. **ATTENTION!**

Distilled water in the cooking compartment leads to corrosion.

- ▶ Do not use distilled water.

Mix 0.4 litres water with a drop of washing-up liquid and pour into the centre of the cooking compartment floor.

3. Press  to switch the appliance on.
4. Press .

5. Use the < or > button to select "EasyClean" .
6. Use the  button to navigate to the next row.
7. Press  to start the cleaning aid.
 - ✓ The cleaning aid will start. The duration will count down on the display.
 - ✓ Once the cleaning aid has run through to the end, an audible signal will sound.
8. Press any button to end the audible signal.
9. After using the cleaning aid, finish cleaning the cooking compartment.
→ "Wiping down the cooking compartment", Page 22

Wiping down the cooking compartment

ATTENTION!

The prolonged presence of moisture in the cooking compartment leads to corrosion.

- ▶ After using the cleaning aid, wipe the cooking compartment clean and allow it to dry fully.

Requirement: The cooking compartment must have cooled down.

1. Open the appliance door and remove the remaining water with an absorbent sponge cloth.
2. Clean the smooth surfaces in the cooking compartment with a dish cloth or a soft brush. Remove stubborn food remnants using a stainless steel scouring pad.
3. Remove limescale with a cloth soaked in vinegar. Then wipe with clean water and rub dry with a soft cloth (including under the door seal).
4. If there is any stubborn dirt that you are unable to remove, run the cleaning aid again once the cooking compartment has cooled down.
5. Leave the cooking compartment to dry with the appliance door open for approx. 1 hour.

16.2 Descaling

To ensure that your appliance continues to operate correctly, it must be descaled regularly.

How frequently you need to run the descaling programme will depend on the water hardness and how many times you have used the steam function. The appliance indicates when only another five or fewer steam-assisted operations are possible. If you do not carry out the descaling, you can no longer set any operation with steam.

Descaling comprises several steps and takes approx. 70–95 minutes:

- Descaling (approx. 55–70 minutes)
- First rinse cycle (approx. 9–12 minutes)
- Second rinse cycle (approx. 9–12 minutes)

For reasons of hygiene, the descaling programme must be run in full.

If descaling is interrupted, you can no longer set any operation. To ensure that the appliance is ready for operation again, carry out two rinse cycles.

Preparing descaling

ATTENTION!

The length of time for which the descaler is left to work is based on the recommended, liquid descaler. Other descalers may damage the appliance.

- ▶ Only use the liquid descaler recommended by us for the descaling programme.

If descaling solution comes into contact with the control panel or other delicate surfaces, it will damage them.

- ▶ Remove descaling solution immediately with water.

1. Mix the descaling solution:
 - 200 ml liquid descaler
 - 400 ml water
2. Open the control panel.
3. Remove the water tank and pour the descaling solution into it.
4. Once the descaling solution has been poured into the water tank, slide the tank back in.
5. Close the control panel.

Setting the descaling process

ATTENTION!

If descaling solution comes into contact with the control panel or other delicate surfaces, it will damage them.

- ▶ Remove descaling solution immediately with water.

Requirement: The appliance must be prepared for descaling. → Page 23

1. Press \odot to switch the appliance on.
2. Press \square .
3. Use the \langle or \rangle button to set "Descaling" \checkmark .
4. Use the \sim button to navigate to the next row.
 - ✓ The duration will appear on the display. You cannot change the duration of the descaling process.
5. Use the \sim button to navigate to the next row.
6. Press \triangleright to start the descaling process.
 - ✓ The descaling process will start. The duration will count down on the display.
 - ✓ Once the descaling process has run through to the end, an audible signal will sound.

Running the first rinse cycle

1. Open the control panel and remove the water tank.
2. Thoroughly rinse the water tank and fill it with fresh water.
3. Slide in the water tank and close the control panel.
4. Press \triangleright to start the rinse cycle.
 - ✓ The rinse cycle will start. The duration will count down on the display.
 - ✓ Once the rinse cycle has run through to the end, an audible signal will sound.

Running the second rinse cycle

1. Open the control panel and remove the water tank.
2. Thoroughly rinse the water tank and fill it with fresh water.
3. Slide in the water tank and close the control panel.
4. Press \triangleright to start the rinse cycle.
 - ✓ The rinse cycle will start. The duration will count down on the display.
 - ✓ Once the rinse cycle has run through to the end, an audible signal will sound.
5. Empty and dry the water tank.
 - "Emptying the water tank", Page 14

17 Rails

To thoroughly clean the rails and the cooking compartment, or to replace the rails, you can remove the rails.

17.1 Detaching the rails

WARNING – Risk of burns!

The shelf supports get very hot

- ▶ Never touch the shelf supports when hot.
- ▶ Always allow the appliance to cool down.
- ▶ Keep children at a safe distance.

1. Lift the rail forwards slightly $\textcircled{1}$ and detach it $\textcircled{2}$.

2. Pull the whole rail to the front $\textcircled{3}$ and remove it.

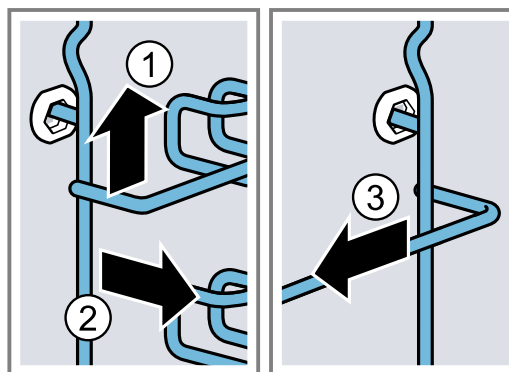

3. Clean the rail.
 - "Cleaning products", Page 20

17.2 Attaching the rails

Notes

- The rails only fit on the right or left.
 - For both rails, ensure that the retaining bracket is at the front.
1. First, push the rail into the middle of the rear socket ① until the rail rests against the cooking compartment wall, and then push this back ②.

2. Push the rail into the front socket ③ until the rail also rests against the cooking compartment wall, and then press this downwards ④.

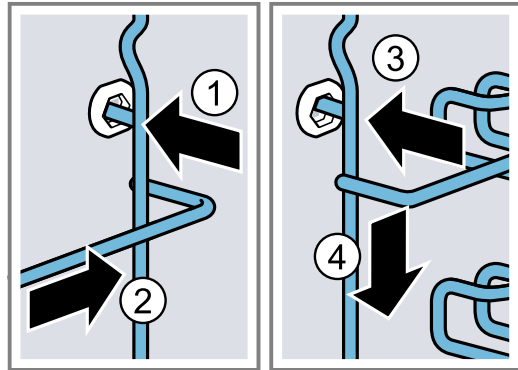

18 Appliance door

To clean the appliance door thoroughly, you can disassemble the appliance door.

⚠ WARNING – Risk of injury!

If the hinges are not secured due to an incomplete lock, they can snap shut with great force.

- ▶ To detach or attach the appliance door, always turn the two locks as far as they will go.
- ▶ If the hinge snaps closed when detaching or attaching the appliance door, do not reach into the hinge – call the after-sales service.

18.1 Detaching the appliance door

Requirements

- Have a torch ready.
 - Have a small slotted screwdriver ready.
 - Have a coin ready.
1. To make it easier to see the door lock, shine the torch into the gap beside the appliance door.

2. Hold the screwdriver horizontally ① and use it to push the door lock (black component) on each side of the door upwards as far as it will go ②.

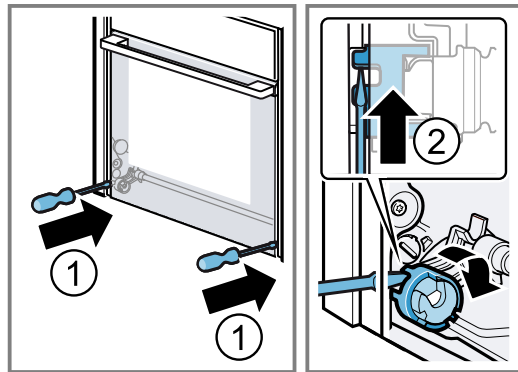

Door lock open

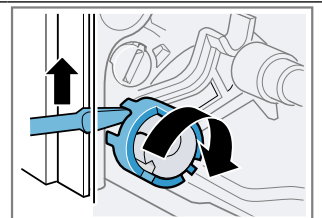

Door lock closed

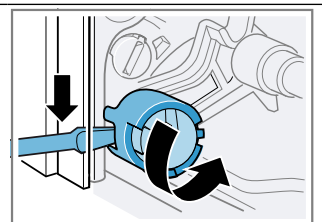

3. Open the appliance door approx. 45° wide.

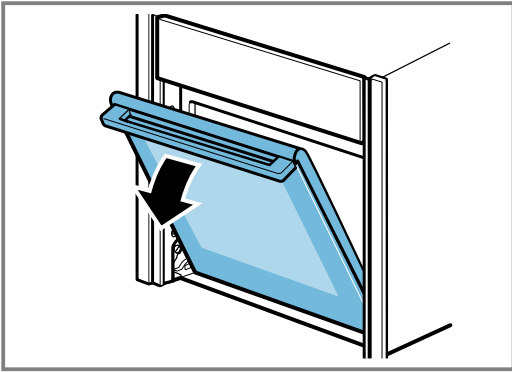

4. Insert the coin in the gap in the lock ① and rotate as far as it will go ②.
- Turn the lock on the left-hand side in a clockwise direction.
 - Turn the lock on the right-hand side in an anti-clockwise direction.

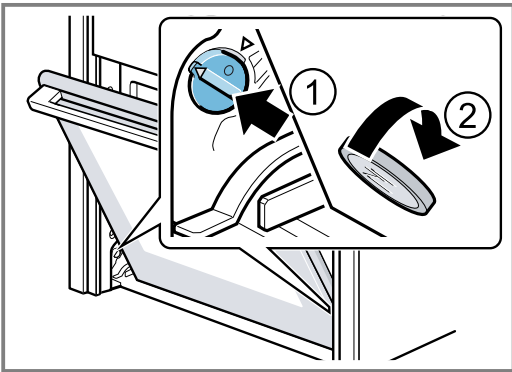

Left-hand lock secured
The arrows point to each other

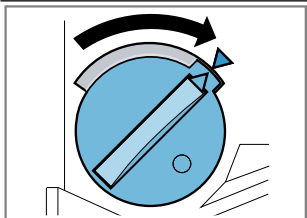

Left-hand lock released

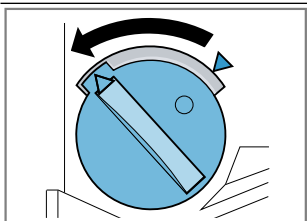

- ✓ The lock audibly engages.

5. ATTENTION!

Opening and closing the appliance door when it is in the lock position damages the door hinges.

- ▶ Never force the appliance door open or closed.
- ▶ If the door hinge has been damaged, call the after-sales service.

Move the appliance door up and down until you hear a quiet click. You can still only move the appliance door slightly.

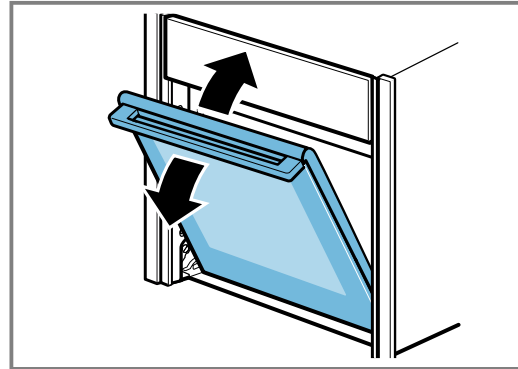

- ✓ The appliance door is in the lock position.

6. ⚠ WARNING – Risk of injury!

The appliance door has a weight of 7–10 kg and may fall if it is not handled carefully.

- ▶ Handle the appliance door carefully.

The door handle is not suitable for carrying the appliance door. The door handle may break off.

- ▶ Never carry the appliance door by the door handle.
- ▶ Grab hold of the appliance door with both hands on the left and right to carry it.

Take hold of the appliance door with both hands, one on the left and one on the right, and rotate the door handle upwards ① until you are able to pull up the appliance door and remove it ②.

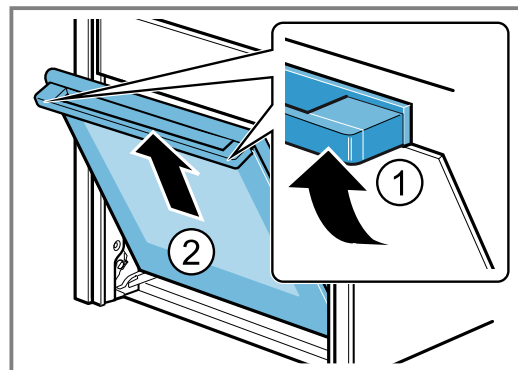

7. Set the appliance door down on a flat, soft, clean surface.

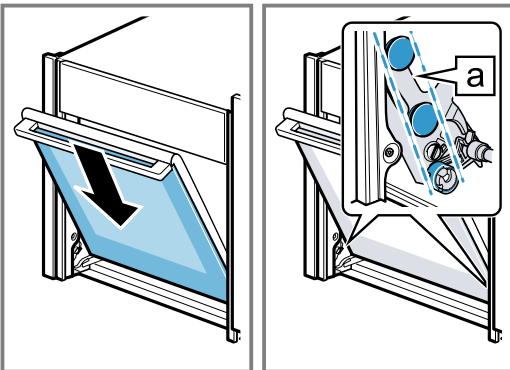

18.2 Attaching the appliance door

- Tip:** Ensure that the appliance door is not wedged at an angle and that it is properly fitted in place.
Attach the appliance door via the left- and right-hand guide rollers simultaneously .

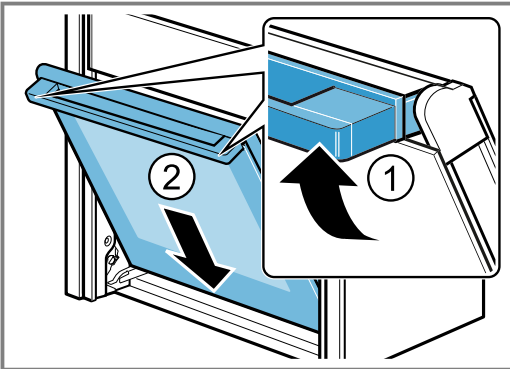

- Rotate the door handle upwards slightly .



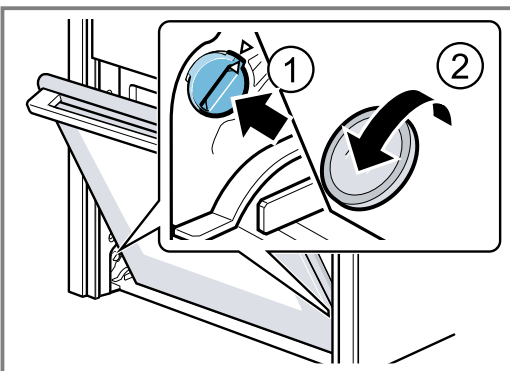

- ✓ The appliance door slides the short distance remaining to the bottom .
- Use a coin to release both locks on the appliance door. Insert the coin in the gap in the lock  and rotate as far as it will go .
 - Turn the lock on the left-hand side in an anti-clockwise direction.
 - Turn the lock on the right-hand side in a clockwise direction.



- Open the appliance door slightly until you hear a quiet click, and then close the appliance door.

- ⚠ WARNING – Risk of injury!**
If the door locks are unsecured, the appliance door may become detached.
▶ After attaching the appliance door, close the left- and right-hand door locks.

Hold the screwdriver horizontally  and use it to push the door lock (black component) on each side of the door downwards as far as it will go .

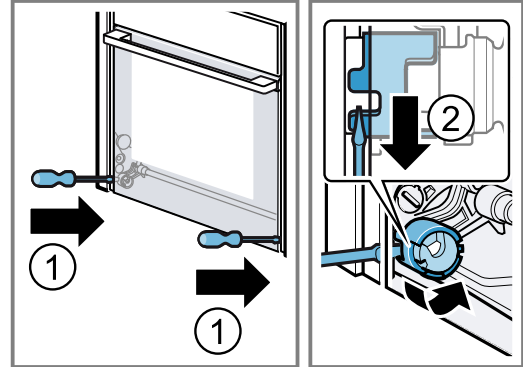



- ✓ The door lock is closed.

18.3 Removing the door panes

To facilitate cleaning, you can remove the door pane.

- ⚠ WARNING – Risk of injury!**
Components inside the appliance door may have sharp edges.
▶ Wear protective gloves.

Requirement: The appliance door is detached.

- Lay the appliance door with the front side facing down on a flat surface that is soft and clean.
- Push on the left- and right-hand side of the appliance door from the outside  until the inner pane is released on both sides.
- Carefully lift the inner pane and remove it in the direction of the arrow .

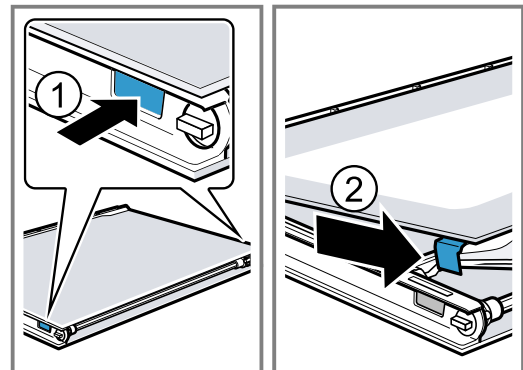

4. Push down on the intermediate pane lightly in the area of [a], and carefully lift the retainer [b] until you are able to pull it out.

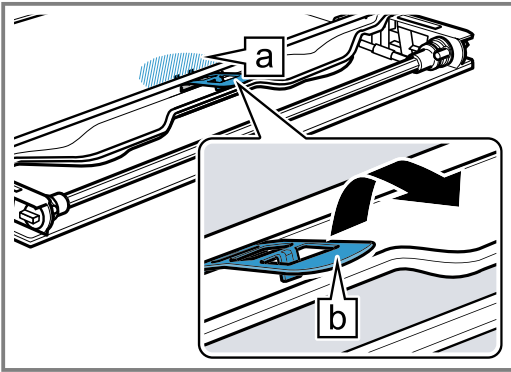

5. Lift the intermediate pane from below ① and remove it in the direction of the arrow ②.

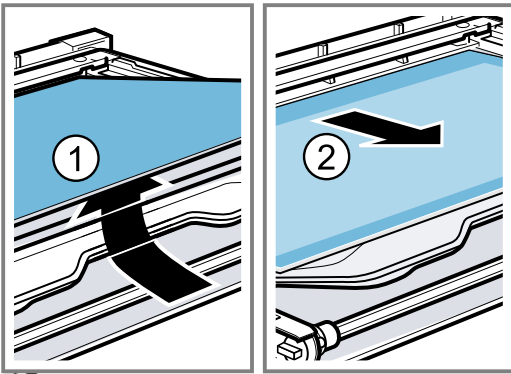

6. **⚠ WARNING – Risk of injury!**
Scatched glass in the appliance door may develop into a crack.
- ▶ Do not use any harsh or abrasive cleaners or sharp metal scrapers to clean the glass on the oven door, as they may scratch the surface.

Clean the door panes on both sides with glass cleaner and a soft cloth.

7. Dry the door panes and refit them.

18.4 Fitting the door panes

⚠ WARNING – Risk of injury!
If a door pane or appliance door has not been installed correctly, this is dangerous.

- ▶ Make sure that all of the door panes and the appliance door have been correctly fitted before you switch the appliance back on again.

1. **Tip:** When fitting the door panes, make sure that they are in the original order.

Insert the intermediate pane in the direction of the arrow and push it in in the direction of the arrow until it is fitted in the frame.

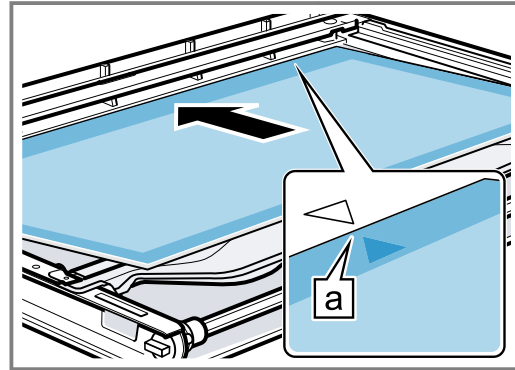

The arrow on the intermediate pane must line up with the arrow on the frame [a].

2. Push down lightly on the first intermediate pane around [a], slide the retainer [b] in at an angle and push down until it clicks into place.

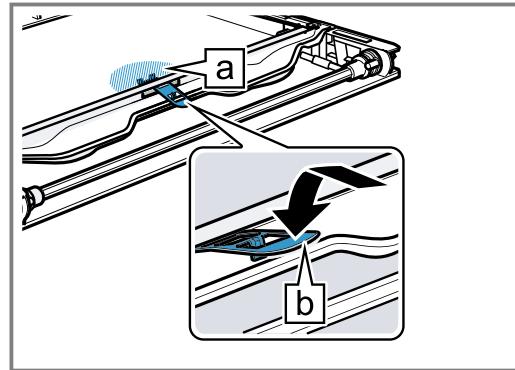

- ✓ The retainer has been inserted.

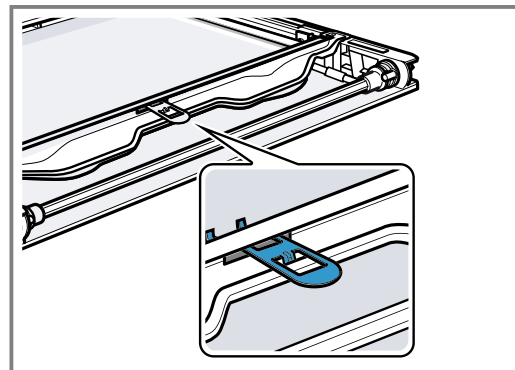

3. Insert the inner pane into the fixing rail at an angle towards the back [a] ①.

4. Push the inner pane from above until it locks into place ②.

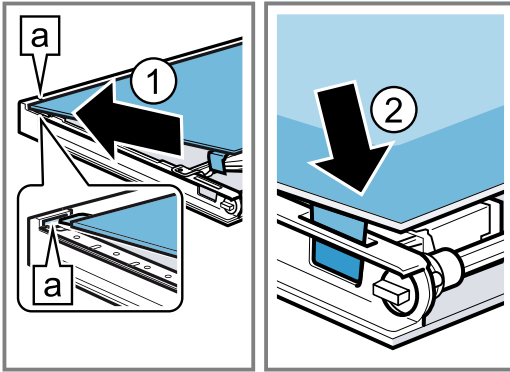

19 Troubleshooting

You can rectify minor faults on your appliance yourself. Read the troubleshooting information before contacting after-sales service. This will avoid unnecessary costs.

⚠ WARNING – Risk of injury!

Improper repairs are dangerous.



- ▶ Repairs to the appliance should only be carried out by trained specialist staff.
- ▶ If the appliance is defective, call Customer Service.

⚠ WARNING – Risk of electric shock!

Incorrect repairs are dangerous.

- ▶ Repairs to the appliance should only be carried out by trained specialist staff.
- ▶ Only use genuine spare parts when repairing the appliance.
- ▶ If the power cord of this appliance is damaged, it must be replaced by trained specialist staff.

19.1 Malfunctions

Fault	Cause and troubleshooting
The appliance is not working.	<p>The circuit breaker is faulty.</p> <ul style="list-style-type: none"> ▶ Check the circuit breaker in the fuse box. <p>There has been a power cut.</p> <ul style="list-style-type: none"> ▶ Check whether the lighting in your kitchen or other appliances are working.
"Language English" appears on the display.	<p>There has been a power cut.</p> <ul style="list-style-type: none"> ▶ Configure the initial configuration settings. → "Initial use", Page 11
"-H-" or "-h-" appears on the display.	<p>Cooking compartment too hot for operating mode.</p> <ol style="list-style-type: none"> 1. Wait until the appliance has cooled down. 2. Start the operating mode again.
The appliance cannot be switched on;  appears on the display.	<p>Automatic childproof lock or childproof lock is activated</p> <ul style="list-style-type: none"> ▶ Press and hold the  button until "Childproof lock deactivated" appears on the display.
Appliance will not start or cuts out during operation.	<p>Different causes are possible.</p> <ul style="list-style-type: none"> ▶ Check any notifications that appear on the display. → "Displaying information", Page 12 <p>Malfunction</p> <ul style="list-style-type: none"> ▶ Call the after-sales service. → "Customer Service", Page 30
The appliance is not heating;  appears on the display.	<p>Demo mode is activated in the basic settings.</p> <ol style="list-style-type: none"> 1. Briefly disconnect the appliance from the power supply by switching the circuit breaker in the fuse box off and then on again. 2. Deactivate Demo mode within the next 3 minutes in the → "Basic settings", Page 19. <p>There has been a power cut.</p> <ul style="list-style-type: none"> ▶ Open and close the appliance door once after a power failure. ✓ The appliance will perform a self-test, after which it will be ready to use.

Fault	Cause and troubleshooting
Time not displayed when appliance switched off.	Basic setting has been changed. <ul style="list-style-type: none"> ▶ Change the basic setting for the clock display. → <i>"Basic settings", Page 19</i>
The control panel cannot be opened.	The circuit breaker is faulty. <ul style="list-style-type: none"> ▶ Check the circuit breaker in the fuse box. <hr/> There has been a power cut. <ul style="list-style-type: none"> ▶ Check whether the lighting in your kitchen or other appliances are working. <hr/> Malfunction <ol style="list-style-type: none"> 1. Call the after-sales service. → <i>"Customer Service", Page 30</i> 2. If there is water in the water tank, empty the water tank: <ul style="list-style-type: none"> - Open the appliance door. - Grip on the right and left below the control panel. - Slowly pull out the control panel and push it upwards.
Steam escaping from ventilation slots during cooking	Escaping steam is not a fault. No action required.
The appliance requests descaling without the counter appearing in advance.	The set water hardness range is too low. <ol style="list-style-type: none"> 1. Descale the appliance. → <i>"Descaling", Page 23</i> 2. Check the water hardness and set this in the basic settings. → <i>"Basic settings", Page 19</i>
The appliance prompts you to rinse it.	During the descaling, the power supply is interrupted or the appliance is switched off. <ul style="list-style-type: none"> ▶ Rinse the appliance twice. → <i>"Descaling", Page 23</i>
"Fill water tank" appears in the display even though the water tank has been filled.	The water tank has not clicked into place. <ul style="list-style-type: none"> ▶ Insert the water tank correctly so that it engages in the holder. → <i>"Filling the water tank", Page 12</i> <hr/> The water tank has fallen out. Shaking has caused parts to come loose in the water tank. The water tank is leaking. <ul style="list-style-type: none"> ▶ Order a new water tank. <hr/> Malfunction <ul style="list-style-type: none"> ▶ Do not use deionised or filtered water. → <i>"Before using for the first time", Page 10</i> <hr/> The sensor is defective. <ul style="list-style-type: none"> ▶ Call the after-sales service. → <i>"Customer Service", Page 30</i>
Buttons are flashing.	Condensation has formed behind the control panel. No action required. As soon as the condensation has evaporated, the buttons no longer flash.
"Popping" sounds can be heard when cooking with steam.	Water vapour requires the cold/heat effect for frozen food. No action required.
The appliance hums during operation and after it is switched off.	Functional test of the pump creates operating noise. No action required.
The appliance hums or clicks when the control panel is opened.	Removing the control panel creates operating noise. No action required.
The interior lighting does not work.	The LED light is defective. <p>Note: Do not remove the glass cover.</p> <ul style="list-style-type: none"> ▶ Call the after-sales service. → <i>"Customer Service", Page 30</i>

Fault	Cause and troubleshooting
Maximum operating time reached.	<p>To prevent the appliance from continuing to run when it is no longer needed, it automatically stops heating after a few hours if the settings are not changed during this time. A notification appears on the display.</p> <p>The point at which the maximum operating time is reached is determined by the corresponding settings for an operating mode.</p> <ol style="list-style-type: none"> 1. Press any button to continue operation. 2. If you do not need to use the appliance, press  to switch it off. <p>Tip: To prevent the appliance from switching off when you do not want it to, set a cooking time. → "Setting the cooking time", Page 15</p>
A message with "D" or "E" appears in the display, e.g. D0111 or E0111.	<p>The electronics have detected a fault.</p> <ol style="list-style-type: none"> 1. Switch the appliance off and on again. <ul style="list-style-type: none"> ✓ If the fault was a one-off, the message disappears. 2. If the message appears again, call the after-sales service. Please specify the exact error message when calling. → "Customer Service", Page 30
The cooking result is not satisfactory.	<p>Settings were unsuitable. Setting values, e.g. temperature or cooking time, depend on the recipe, quantity and food.</p> <ul style="list-style-type: none"> ▶ Next time, set lower or higher values. <p>Tip: A lot of information about the food preparation and corresponding setting values can be found on our website www.neff-international.com.</p>

20 Disposal

Find out here how to dispose of old appliances correctly.

20.1 Disposing of old appliance

Valuable raw materials can be reused by recycling.

1. Unplug the appliance from the mains.
2. Cut through the power cord.
3. Dispose of the appliance in an environmentally friendly manner.

Information about current disposal methods are available from your specialist dealer or local authority.



This appliance is labelled in accordance with European Directive 2012/19/EU concerning used electrical and electronic appliances (waste electrical and electronic equipment - WEEE).

The guideline determines the framework for the return and recycling of used appliances as applicable throughout the EU.

21 Customer Service

If you have any queries on use, are unable to rectify faults on the appliance yourself or if your appliance needs to be repaired, contact Customer Service. Detailed information on the warranty period and terms of warranty in your country is available from our after-sales service, your retailer or on our website.

If you contact Customer Service, you will require the product number (E-Nr.) and the production number (FD) of your appliance.

The contact details for Customer Service can be found in the enclosed Customer Service directory or on our website.

This product contains light sources from energy efficiency class G. These light sources are available as a spare part and should only be replaced by trained specialist staff.

21.1 Product number (E-Nr.) and production number (FD)

You can find the product number (E-Nr.) and the production number (FD) on the appliance's rating plate. On some appliances with steam-assisted cooking, you will find the rating plate behind the control panel.

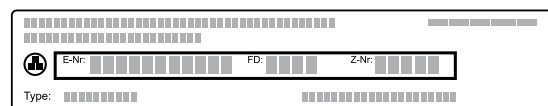

Make a note of your appliance's details and the Customer Service telephone number to find them again quickly.

22 How it works

Here, you can find the ideal settings for various types of food as well as the best accessories and cookware. We have perfectly tailored these recommendations to your appliance.

22.1 General cooking tips

Please take note of the following information when cooking all types of food.

- The temperature and cooking time depend on the amount of food and the recipe. Settings ranges are specified for this reason. Try using the lower values to start with.
- The setting values apply to food placed in the cooking compartment while the cooking compartment is still cold. Do not place accessories into the cooking compartment until it has finished preheating.
- Remove any accessories that are not being used from the cooking compartment.

22.2 Baking tips

- Dark-coloured metal baking tins are most suitable for baking cakes, bread and other baked goods.
- Use wide, shallow cookware for bakes and gratins. Food takes longer to cook in deep, narrow cookware and it browns more on top.
- Silicone moulds are not suitable.
- If you are cooking bakes directly in the universal pan, place the universal pan into the cooking compartment at level 2.
- The setting values for bread dough apply to both dough placed on a baking tray and dough placed in a loaf tin.

ATTENTION!

When the cooking compartment is hot, any water inside it will create steam. The change in temperature may cause damage.

- ▶ Never pour water into the cooking compartment when it is still hot.
- ▶ Never place cookware containing water on the cooking compartment floor.

Shelf positions

If you are using the CircoTherm hot air heating function, you can choose between shelf positions 1, 2, 3 and 4.

Baking on one level	Shelf position
Tall baked items and tins/dishes on the wire rack	2
Shallow baked items/baking trays	3

Baking on two or more levels	Shelf position
2 levels	
■ Universal pan	3
■ Baking tray	1
2 levels	
■ Baking tins on two wire racks	3
	1

Baking on two or more levels	Shelf position
3 levels	
■ Baking tray	4
■ Universal pan	3
■ Baking tray	1
4 levels	
■ 4 wire racks with greaseproof paper	4
	3
	2
	1

Use the CircoTherm hot air heating function.

Notes

- Items that are placed in the appliance on baking trays or in baking tins/dishes at the same time will not necessarily be ready at the same time.
- If you opt for steam-assisted cooking, you can only cook on one level.

22.3 Roasting, braising and grilling tips

- The recommended settings are for fridge-temperature food and unstuffed, oven-ready poultry.
- Place the poultry onto the cookware breast-side or skin-side down.
- Turn roasting joints, grilled items or whole fish after approx. $\frac{1}{2}$ to $\frac{2}{3}$ of the specified time.

Roasting on the wire rack

Food roasted on the wire rack will become very crispy on all sides. You can roast large poultry, for example, or multiple individual pieces at the same time.

- Roast pieces of a similar weight and thickness. The grilled food will brown evenly and will remain succulent and juicy.
- Place the food to be roasted directly on the wire rack.
- To catch any liquids that drip down, place the universal pan, with the wire rack inside it, into the cooking compartment at the specified shelf height.
- Add up to $\frac{1}{2}$ litre of water to the universal pan, depending on the size and type of food that you want to roast.

You can make a sauce from the juices that are collected. This also means that less smoke is produced and the cooking compartment does not become as dirty.

Roasting in cookware

If you cover the cookware when you cook your food, this will keep the cooking compartment cleaner.

General information about roasting in cookware

- Use heat-resistant, ovenproof cookware.
- Place the cookware on the wire rack.
- Glass cookware is best.
- Follow the manufacturer's instructions for your roasting dishes.

Roasting in uncovered cookware

- Use a deep roasting dish.

- If you do not have any suitable cookware, you can use the universal pan.

Roasting in covered cookware

- Use a suitable lid that seals well.
- When roasting meat, there should be at least 3 cm between the food and the lid. The meat may expand.

WARNING – Risk of scalding!

Very hot steam may escape when the lid is opened after cooking. Steam may not be visible, depending on the temperature.

- ▶ Lift the lid in such a way that the hot steam can escape away from you.
- ▶ Keep children away from the appliance.

Grilling

Grill food if you want it to be crispy.

- When grilling several food items, choose pieces that are of a similar weight and thickness. The grilled food will brown evenly and will remain succulent and juicy.

- Place the food to be grilled directly onto the wire rack.
- To catch any liquids that drip down, place the universal pan into the cooking compartment at least one level below the wire rack.

Notes

- The grill element switches on and off continuously. This is normal. The temperature that you set determines how frequently this occurs.
- Smoke may be produced when grilling.

22.4 Cooking frozen products

- Do not use heavily frosted frozen products.
- Remove any ice.
- Some frozen products may be unevenly pre-baked. Uneven browning may remain even after baking.













22.5 Cooking ready meals

- Take ready meals out of the packaging.
- If you are warming or cooking the ready meal in cookware, make sure that the cookware is heat-resistant.

22.6 List of foods

Recommended settings for a variety of foods, sorted into food categories.

Recommended settings for various types of food

Food	Accessories/cookware	Shelf position	Heating function → Page 7	Temperature in °C	Steam intensity	Cooking time in mins
Sponge cake, 2 levels	Ring-shaped tin or Loaf tin	3+1		140–160	-	60–80
Sponge cake, delicate	Loaf tin	2		150–170	-	60–80
Fruit tart or cheesecake with shortcrust pastry base	Springform cake tin, diameter 26 cm	2		170–190	-	60–80
Sponge cake, 6 eggs	Springform cake tin, diameter 28 cm	2		150–170 ¹	-	30–50
Sponge cake, 6 eggs	Springform cake tin, diameter 28 cm	2		1. 150–160 2. 150–160	Low -	1. 10 2. 25–35
Sponge cake, 6 eggs	Springform cake tin, diameter 28 cm	2		150–160	-	50–60
Shortcrust tart with moist topping	Universal pan	3		160–180	-	55–75
Yeast cake with moist topping	Universal pan	3		180–200	-	30–40
Swiss roll	Baking tray	3		180–200 ¹	-	8–15
Swiss roll	Baking tray	3		180–200 ¹	Low	10–15
Small yeast cakes	Baking tray	3		160–180	Medium	25–35
Biscuits	Baking tray	3		140–160	-	15–30
Biscuits, 2 levels	Universal pan + Baking tray	3+1		140–160	-	15–30

¹ Preheat the appliance.

Food	Accessories/cook-ware	Shelf position	Heating function → Page 7	Temperature in °C	Steam intensity	Cooking time in mins
Biscuits, 3 levels	1 pcs Universal pan + 2 pcs Baking tray	4+3+1		140–160	-	15–30
Bread, without a tin, 750 g	Universal pan or Loaf tin	2		1. 210–220 ¹ 2. 180–190	-	1. 10–15 2. 25–35
Bread, free-form, 750 g	Universal pan or Loaf tin	2		1. 210 - 220 2. 180 - 190	High -	1. 10 - 15 2. 25 - 35
Bread, without a tin, 1500 g	Universal pan or Loaf tin	2		1. 210–220 ¹ 2. 180–190	-	1. 10–15 2. 40–50
Bread, free-form, 1500 g	Universal pan or Loaf tin	2		1. 210 - 220 2. 180 - 190	High -	1. 10 - 15 2. 45 - 55
Bread, without a tin, 1500 g	Loaf tin	2		200–210	-	35–45
Flatbread	Universal pan	3		220 - 230	High	20 - 30
Bread rolls, fresh	Baking tray	3		200–220	Medium	20–30
Pizza, fresh, on a baking tray	Baking tray	3		200 - 220	-	25 - 35
Pizza, fresh, on a baking tray, on 2 levels	Universal pan + Baking tray	3+1		180 - 200	-	35 - 45
Pizza, fresh, thin-crust, on a pizza tray	Pizza tray	2		220 - 230	-	20 - 30
Quiche	Tart dish or tin , Black tray	3		190–210	-	30–40
Tarte flambée	Universal pan	3		260 - 280 ¹	-	10 - 15
Bake, savoury, cooked ingredients	Ovenproof dish	2		150 - 170	Medium	40 - 50
Potato gratin, raw ingredients, 4 cm deep	Ovenproof dish	2		160 - 190	-	50 - 70
Chicken, 1 kg, unstuffed	Wire rack	2		200 - 220	-	60 - 70
Chicken, 1 kg, unstuffed	Wire rack	2		190-210	Medium	50-60
Small chicken portions, 250 g each	Wire rack	3		220 - 230	-	30 - 35
Small chicken portions, 250 g each	Wire rack	3		200 - 220	Medium	30 - 45
Goose, unstuffed, 3 kg	Wire rack	2		160 - 180	-	120 - 150
Goose, unstuffed, 3 kg	Wire rack	2	1. 2. 3.	1. 130 - 140 2. 150 - 160 3. 170 - 180	Medium Medium -	1. 110 - 120 2. 20 - 30 3. 30 - 40
Joint of pork without rind, e.g. neck, 1.5 kg	Uncovered cook-ware	2		180 - 190	-	110 - 130
Joint of pork without rind, e.g. neck, 1.5 kg	Uncovered cook-ware	2		190–200	-	120–140
Joint of pork with rind, e.g. shoulder, 2 kg	Uncovered cook-ware	2	1. 2. 3.	1. 100 2. 170 - 180 3. 200 - 210	High Low -	1. 25 - 30 2. 70 - 90 3. 20 - 25

¹ Preheat the appliance.

Food	Accessories/cook-ware	Shelf position	Heating function → Page 7	Temperature in °C	Steam intensity	Cooking time in mins
Fillet of beef, medium, 1 kg	Wire rack	2		210 - 220	-	40 - 50
Fillet of beef, medium, 1 kg	Uncovered cookware	2		190 - 200	Low	50 - 60
Pot-roasted beef, 1.5 kg	Covered cookware	2		200 - 220	-	130 - 160
Pot-roasted beef, 1.5 kg	Covered cookware	2		200 - 220	-	140 - 160
Sirloin, medium, 1.5 kg	Wire rack	2		220 - 230	-	60 - 70
Sirloin, medium, 1.5 kg	Uncovered cookware	2		190 - 200	Low	65 - 80
Burger, 3-4 cm thick	Wire rack	4		290	-	25 - 30
Leg of lamb, boned, medium, 1.5 kg	Uncovered cookware	2		170 - 190	-	50 - 80
Leg of lamb, boned, medium, 1.5 kg	Uncovered cookware	2		170 - 180	Low	80 - 90
Fish, grilled, whole, 300 g, e.g. trout	Wire rack	2		170 - 190	-	20 - 30
Fish, baked, whole, 300 g, e.g. trout	Universal pan	2	1. 2.	1. 170-180 2. 160-170	Low -	1. 15-20 2. 5-10

¹ Preheat the appliance.

Desserts

Making yoghurt

1. Remove the accessories and shelves from the cooking compartment.
2. Heat 1 litre of whole milk (3.5% fat) to 90 °C on the hob and then leave it to cool down to 40 °C. It is sufficient to heat UHT milk to 40 °C.
3. Mix 150 g of chilled yoghurt into the milk.

4. Pour the mixture into small containers, e.g. cups or small jars.
5. Cover the containers with film, e.g. cling film.
6. Place the containers on the cooking compartment floor.
7. Use the recommended settings when configuring the appliance settings.
8. After making the yoghurt, leave it to cool in the refrigerator for at least 12 hours.

Recommended settings for desserts and compote

Food	Accessories/cook-ware	Shelf position	Heating function → Page 7	Temperature in °C	Steam intensity	Cooking time in mins
Yoghurt	Individual moulds	Cooking compartment floor		1	-	300 - 360

22.7 Special cooking methods and other applications

Information and recommended settings for special cooking methods and other applications, e.g. slow cooking or preserving.

Slow cooking

Cook prime cuts of meat slowly at a low temperature, e.g. tender cuts of beef, veal, lamb or poultry.

Slow cooking poultry or meat

Note: When using the Slow cooking heating function, you cannot delay the start of the program by setting an end time.

Requirement: The cooking compartment must be cold.

1. Use fresh, clean, hygienic meat without bones.
2. Place the cookware onto the wire rack at level 2 in the cooking compartment.
3. Preheat the cooking compartment and cookware for approx. 15 minutes.
4. Sear the meat on all sides on the hob at a very high heat.
5. Immediately place the meat into the pre-warmed cookware in the cooking compartment. To ensure that the climate in the cooking compartment remains constant, keep the cooking compartment door closed during slow cooking.
6. After slow cooking, remove the meat from the cooking compartment.

Recommended settings for slow cooking

Food	Accessory/cook-ware	Shelf position	Searing time in mins	Heating function → Page 7	Temperature in °C	Cooking time in mins
Duck breast, medium rare, 300 g each	Uncovered cook-ware	2	6 - 8		90 ¹	45 - 60
Fillet of pork, whole	Uncovered cook-ware	2	4 - 6		80 ¹	45 - 70
Fillet of beef, 1 kg	Uncovered cook-ware	2	4 - 6		80 ¹	90 - 120
Veal medallions, 4 cm thick	Uncovered cook-ware	2	4		80 ¹	30 - 50
Saddle of lamb, boneless, 200 g each	Uncovered cook-ware	2	4		80 ¹	30 - 45

¹ Preheat the appliance.

Proving dough

Always allow dough to prove in two steps: Once in their entirety (1. – dough fermentation) and a second time in the baking tin (2. – final fermentation).

Requirement: The cooking compartment is cold.

1. Dough fermentation:

- Slide the wire rack into the cooking compartment.
- Place the dough in a bowl onto the wire rack.

- Use the recommended settings when configuring the appliance settings.
- Do not open the appliance door while the dough is proving, otherwise moisture will escape.

2. Final fermentation:

- Continue processing the dough and turn it into the final shape for baking.
- Place the dough in the specified shelf position.

3. Wipe the cooking compartment dry before baking.

Recommended settings for proving dough

Food	Accessory/cookware	Shelf position	Heating function → Page 7	Temperature in °C	Cooking time in mins
Rich dough, e.g. panettone	Bowl on wire rack	1. 2	1.	1. 2	1. 40–90
	Tin/dish on the wire rack	2. 2	2.	2. 2	2. 30–60
White bread	Bowl on wire rack	1. 2	1.	1. 1	1. 30–40
	Universal pan	2. 2	2.	2. 1	2. 15–25

Defrosting

You can defrost frozen food in your appliance.

Tips for defrosting food

- You can use the appliance to defrost frozen fruit, vegetables or baked goods.
- It is better to defrost poultry, meat and fish in the refrigerator.
- Remove frozen food from its packaging before you defrost it.
- The recommended settings are for freezer-temperature food (-18 °C).
- When defrosting food, use the following shelf positions:
 - 1 wire rack: Shelf position 2
 - 2 wire racks: Shelf positions 3 + 1
- Stir or turn the food 1-2 times during defrosting. Turn large items several times. Split the food into smaller pieces as it defrosts. Remove pieces that have already defrosted from the cooking compartment.

- Once the food has defrosted, switch off the appliance and leave the food in the appliance for another 10 to 30 minutes to allow the temperature to equalise.

Reheating



You can use steam-assisted reheating to gently warm up food. The food tastes and looks as though it has been freshly cooked. You can even warm and crisp up baked goods from the day before.

Tips for reheating food

- Use uncovered, heat-resistant cookware that is suitable for cooking with steam.
- Use wide, shallow cookware. Reheating takes longer if you use cold cookware.
- Place the cookware on the wire rack.
- Place food that you are not reheating in cookware (e.g. bread rolls) directly onto the wire rack at level 2.
- Do not cover the food.
- Do not open the cooking compartment door while the food is being reheated, otherwise large amounts of steam will escape.

- Wipe the cooking compartment dry after using it to reheat food.

Recommended settings for reheating

Food	Accessories/cook-ware	Shelf position	Heating function → Page 7	Temperature in °C	Steam intensity	Cooking time in mins
Pizza, cooked	Wire rack	2		170 - 180 ¹	-	5 - 15
Bread rolls, baguette, baked	Wire rack	2		160 - 170 ¹	-	10 - 20

¹ Preheat the appliance.

Keeping food warm

Tips for keeping food warm

- You can keep cooked food warm at 70 °C using the "top/bottom heating" function. This prevents condensation from forming and you will not have to wipe down the cooking compartment.
- Do not cover the food.
- Do not keep food warming for longer than 2 hours.

- Be aware that some types of food will actually continue cooking when you are keeping them warm in the oven.

The different added steam levels are suitable for keeping the following foods warm:

- Level 1: Joints and briefly roasted food
- Level 2: Bakes and side dishes
- Level 3: Stews and soups

22.8 Test dishes

The information in this section is provided for test institutes to facilitate testing of the appliance in accordance with EN 60350-1.



Baking

- The setting values apply to food that is placed into a cold cooking compartment.
- Please take note of the information on preheating in the recommended settings tables. These setting values assume that the rapid heat-up function is not being used.
- For baking, use the lower of the specified temperatures to start with.
- Items that are placed in the appliance on baking trays or in baking tins/dishes at the same time will not necessarily be ready at the same time.
- Shelf positions when baking on 2 levels:
 - Universal pan: Shelf position 3

- Baking tray: Shelf position 1
- Baking tins/dishes on the wire rack:
 - First wire rack: Shelf position 3
 - Second wire rack: Shelf position 1

- Shelf positions when baking on 3 levels:
 - Baking tray: Shelf position 4
 - Universal pan: Shelf position 3
 - Baking tray: Shelf position 1
- Hot water sponge cake
 - When baking on two levels, place the springform tins at diagonally opposite corners of the wire racks.

Recommended settings for baking

Food	Accessories/cook-ware	Shelf position	Heating function → Page 7	Temperature in °C	Steam intensity	Cooking time in mins
Viennese whirls	Baking tray	3		140 - 150 ¹	-	25 - 40
Viennese whirls	Baking tray	3		140 - 150 ¹	-	25 - 40
Viennese whirls, on 2 levels	Universal pan + Baking tray	3+1		140 - 150 ¹	-	30 - 40

¹ Preheat the appliance for five minutes. Do not use the rapid heating function.

² Preheat the appliance. Do not use the rapid heating function.

Food	Accessories/cook-ware	Shelf position	Heating function → Page 7	Temperature in °C	Steam intensity	Cooking time in mins
Viennese whirls, on 3 levels	x 2 Baking tray + x 1 Universal pan	4+3+1		130 - 140 ¹	-	35 - 55
Small cakes	Baking tray	3		160 ¹	-	20 - 30
Small cakes	Baking tray	3		150 ¹	-	25 - 35
Small cakes, on 2 levels	Universal pan + Baking tray	3+1		150 ¹	-	25 - 35
Small cakes, on 3 levels	x 2 Baking tray + x 1 Universal pan	4+3+1		140 ¹	-	35 - 45
Hot water sponge cake	Springform cake tin, diameter 26 cm	2		160 - 170 ²	-	25 - 35
Hot water sponge cake	Springform cake tin, diameter 26 cm	2		160 - 170 ²	-	30 - 40
Hot water sponge cake	Springform cake tin, diameter 26 cm	2		1. 150 - 160 2. 150 - 160	Low -	1. 10 2. 20 - 25
Hot water sponge cake, on 2 levels	Springform cake tin, diameter 26 cm	3+1		150 - 170 ²	-	30 - 50

¹ Preheat the appliance for five minutes. Do not use the rapid heating function.

² Preheat the appliance. Do not use the rapid heating function.

Recommended settings for grilling

Food	Accessory/cookware	Shelf position	Heating function → Page 7	Temperature in °C	Cooking time in mins
Toasting bread	Wire rack	4		290 ¹	4-6

¹ Do not preheat the appliance.

23 Installation instructions

Observe this information when installing the appliance.



23.1 General installation instructions

Follow these instructions before you start with the installation of the appliance.

- The safe operation of this appliance can only be guaranteed if it has been installed to a professional standard in accordance with these installation instructions. The installer shall be liable for damages incurred as a result of incorrect installation.

- Do not use the door handle for the transport or installation.
- Check the appliance for damage after unpacking it. Do not connect the appliance if it has been damaged in transit.
- Before starting up the appliance, remove any packaging material and adhesive film from the cooking compartment and the door.
- Proceed in accordance with the installation sheets for installing accessories.
- Fitted units must be heat-resistant up to 95 °C, and adjacent unit fronts up to 70 °C.

- Do not install the appliance behind a decorative door or the door of a kitchen unit. There is a risk of overheating.
 - Cut-out work on the units should be carried out before installing the appliance. Remove any shavings. Otherwise, the correct operation of electrical components may be adversely affected.
 - The mains socket for the appliance must either be located in the hatched area **a** or outside of the area where the appliance is installed.
- Any unsecured units must be secured to the wall using a standard bracket **b**.

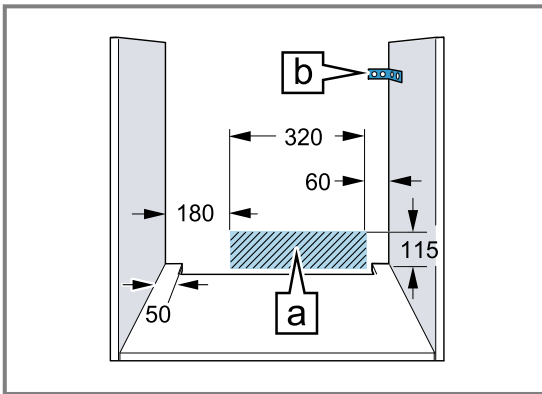

- For appliances that have a hinged switch panel, make sure that the switch panel does not hit adjacent kitchen units when you open it.
- Wear protective gloves so that you do not cut yourself. Parts that are accessible during installation may have sharp edges.
- Dimensions of the figures in mm.

⚠ WARNING – Danger: Magnetism!

Permanent magnets are used in the control panel or in the controls. They may affect electronic implants, e.g. pacemakers or insulin pumps.

- ▶ Wearers of electronic implants must stay at least 10 cm away from the control panel or controls during the installation.

⚠ WARNING – Risk of fire!

It is dangerous to use an extended power cord and non-approved adapters.

- ▶ Do not use extension cables or multiple socket strips.

- ▶ If the power cord is too short, contact Customer Service.
- ▶ Only use adapters approved by the manufacturer.

ATTENTION!

Carrying the appliance by the door handle could break it. The door handle cannot support the weight of the appliance.

- ▶ Do not carry or hold the appliance by the door handle.

23.2 Appliance dimensions

You will find the dimensions of the appliance here

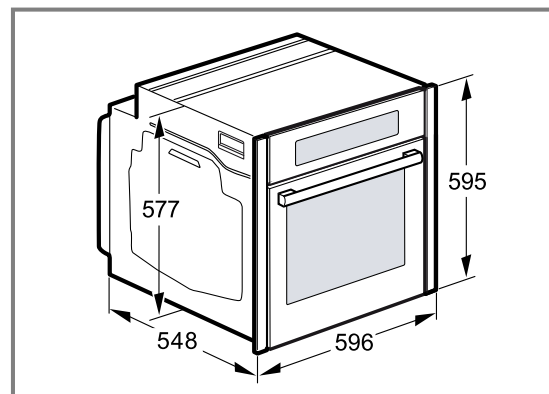

23.3 Installation below a worktop

Observe the installation dimensions and the installation instructions when installing below a worktop.

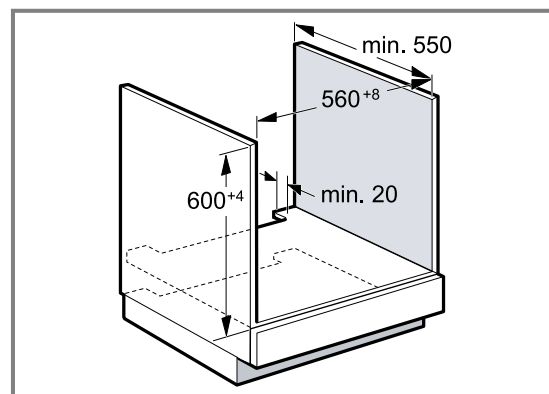

- To ventilate the appliance, the intermediate floor must have a ventilation cut-out.
- The worktop must be secured to the built-in unit.
- Observe any available installation instructions for the hob.

23.4 Installation underneath a hob

If the appliance is installed under a hob, the following minimum dimensions must be adhered to (including substructure, if applicable).

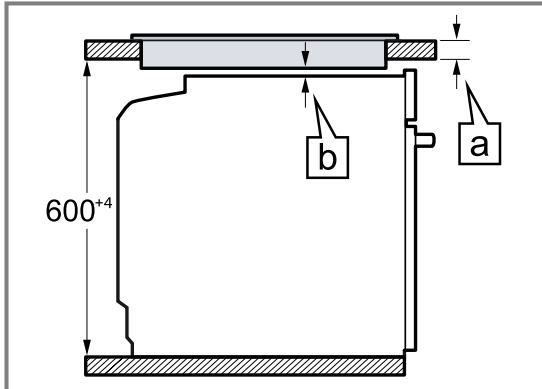

The minimum worktop thickness \boxed{b} a is based on the required minimum clearance \boxed{a} .

Hob type	a raised in mm	a flush in mm	b in mm
Induction hob	37	38	5
Full-surface induction hob	47	48	5
Gas hob	27	38	5
Electric hob	27	30	2

23.5 Installation in a tall unit

Observe the installation dimensions and the installation instructions when installing in a tall unit.

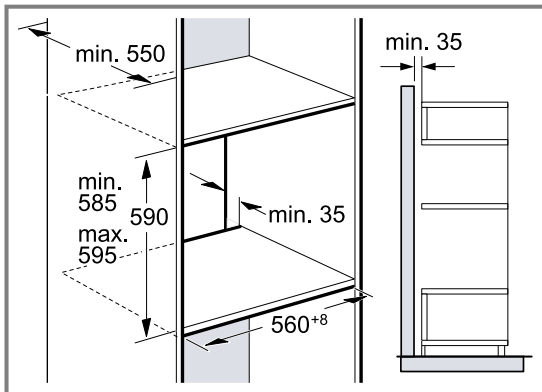

- To ventilate the appliance, the intermediate floors must have a ventilation cut-out.
- If the tall unit has another back panel in addition to the element back panels, this must be removed.
- Only fit the appliance up to a height which allows accessories to be easily removed.

23.6 Corner installation

Observe the installation dimensions and the installation instructions when installing in a corner.

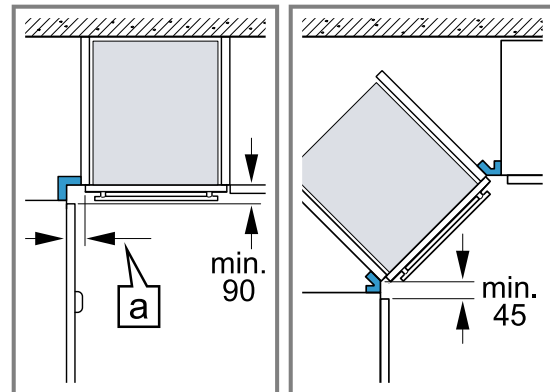

- To ensure that the appliance door can be opened, you must take the minimum dimensions into consideration when installing in a corner. The dimension \boxed{a} is dependent on the thickness of the unit front and the handle.

23.7 Electrical connection

In order to safely connect the appliance to the electrical system, follow these instructions.

- The appliance corresponds to protection class I and must only be operated with a protective earth connection.
- The fuse protection must correspond to the power rating specified on the appliance's rating plate and to local regulations.
- The appliance must be disconnected from the power supply whenever installation work is being carried out.

- The appliance must only be connected using the power cable provided.
- The power cable must be plugged in at the rear of the appliance until you hear a clicking sound. A 3 m power cable can be obtained from the after-sales service.
- The power cable must only be replaced with a cable from the original manufacturer. This is available from after-sales service.
- Contact protection must be ensured during the installation.

Electrically connect the appliance with the protective contact plug

Note: The appliance must only be connected to a protective contact socket that has been correctly installed.

- ▶ Insert the plug into the protective contact socket. When the appliance is installed, the mains plug of the power cord must be freely accessible. If free access to the mains plug is impossible, an all-pole isolating switch must be integrated into the permanent electrical installation in accordance with the installation regulations.

Electrically connecting an appliance without a protective contact plug

Note: Only a licensed professional may connect the appliance. Damage caused by incorrect connection is not covered under the warranty.

An all-pole isolating switch must be integrated into the permanent electrical installation according to the installation regulations.

1. Identify the phase and neutral conductors in the socket.
The appliance may be damaged if it is not connected correctly.
2. Connect the hob in accordance with the connection diagram.
See the rating plate for the voltage.
3. Connect the wires of the mains power cable according to the colour coding:
 - Green/yellow = Protective conductor ⊕
 - Blue = Neutral conductor
 - Brown = Phase (external conductor)

23.8 Installing the appliance

Note: Do not use a cordless screwdriver to secure the panels. This may damage the panels.

1. If required, you can adjust the gap between the appliance door and the panels using the adjustment screws on the left and right.

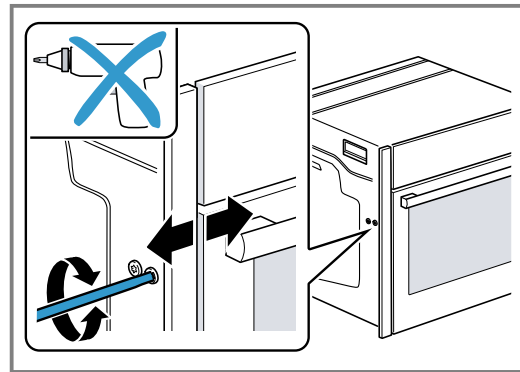

Turning the screws clockwise makes the gap larger
Turning the screws anti-clockwise makes the gap smaller

2. Push the appliance in fully.
Do not kink or trap the connecting cable, or route it over sharp edges.
3. Centre the appliance.

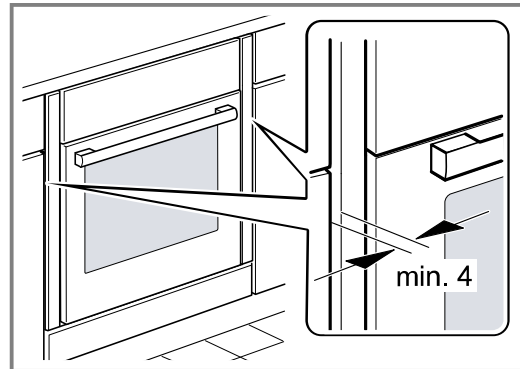

There must be an air gap of at least 4 mm between the appliance and adjacent unit fronts.

4. Open the appliance door slightly and unscrew panels on the left and right.

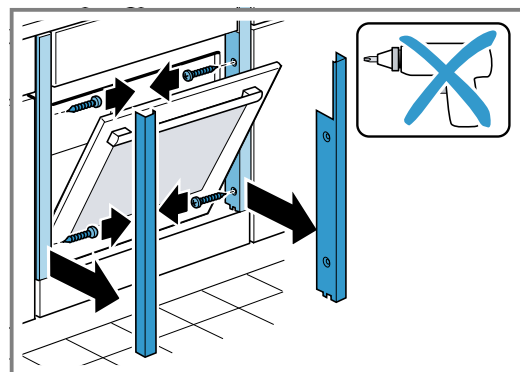

5. Close the appliance door.

6. If required, you can adjust the height of the appliance door using the adjustment screws on the left and right.

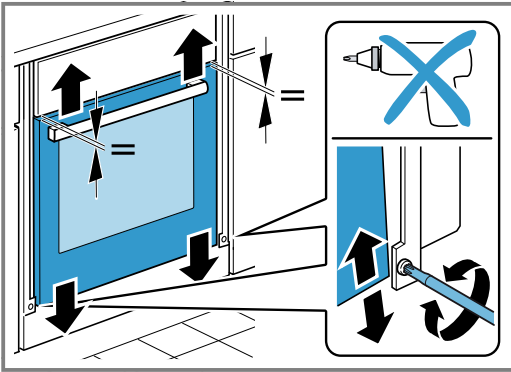

Turning the screws clockwise makes the gap smaller
Turning the screws anti-clockwise makes the gap larger

7. Screw the appliance into place.

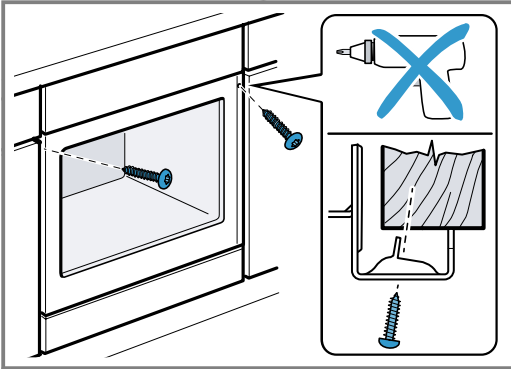

8. Open the appliance door slightly, then refit the panels and screw them in place, first at the top and then at the bottom.

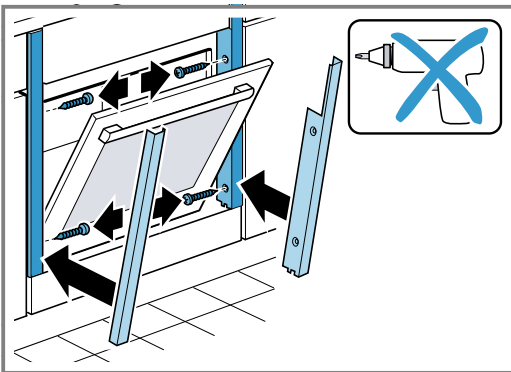

Note: The gap between the worktop and the appliance must not be closed by additional battens. Thermal insulation strips must not be fitted to the side panels of the surround unit.

23.9 Removing the appliance

1. Disconnect the appliance from the power supply.
2. Open the appliance door slightly and unscrew the left and right-hand panels.
3. Undo the fastening screws.
4. Lift the appliance slightly and pull it out completely.

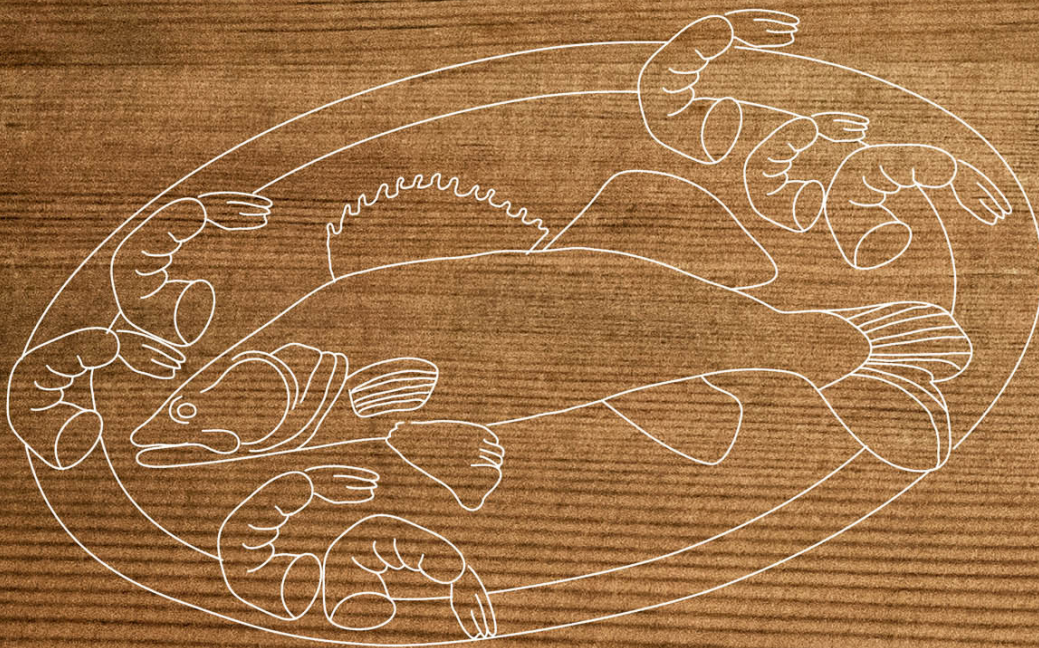

Valid within Great Britain:
Imported to Great Britain by
BSH Home Appliances Ltd.
Grand Union House
Old Wolverton Road
Wolverton, Milton Keynes
MK12 5PT
United Kingdom

REGISTER YOUR PRODUCT
ONLINE NEFF-HOME.COM



Constructa-Neff Vertriebs-GmbH
Carl-Wery-Straße 34
81739 München
GERMANY

9001638676
010420
en