

Oven

User manual and installation  
instructions

**B64VS71.0B**

Further information and explanations are available online:



## Table of contents

### INFORMATION FOR USE

1	Safety.....	2
2	Preventing material damage .....	5
3	Environmental protection and saving energy .....	6
4	Familiarising yourself with your appliance .....	7
5	Functions.....	8
6	Accessories.....	11
7	Before using for the first time .....	12
8	Basic operation .....	13
9	Steam.....	14
10	Time-setting options.....	17
11	Dishes .....	18
12	Favourites.....	20
13	Childproof lock.....	20
14	Rapid heating .....	20
15	Basic settings.....	21
16	Home Connect .....	22
17	Cleaning and servicing.....	24
18	Pyrolytic self-cleaning cleaning function.....	25
19	Easy Clean cleaning aid .....	27
20	Descaling.....	27
21	Drying .....	28
22	Rails .....	29
23	Appliance door.....	29
24	Troubleshooting.....	34
25	Disposal.....	37
26	Customer Service.....	37
27	Information regarding Free and Open Source Software.....	37
28	Declaration of Conformity .....	38
29	How it works.....	38

30	INSTALLATION INSTRUCTIONS .....	47
30.1	General installation instructions.....	47

## 1 Safety

Observe the following safety instructions.

### 1.1 General information

- Read this instruction manual carefully.
- Keep the instruction manual and the product information safe for future reference or for the next owner.
- Do not connect the appliance if it has been damaged in transit.

### 1.2 Intended use

This appliance is designed only to be built into kitchen units. Read the special installation instructions.

Only a licensed professional may connect appliances without plugs. Damage caused by incorrect connection is not covered under the warranty.

Only use this appliance:

- To prepare meals and drinks.
- in private households and in enclosed spaces in a domestic environment.
- up to an altitude of max. 4000 m above sea level.

### 1.3 Restriction on user group

This appliance may be used by children aged 8 or over and by people who have reduced physical, sensory or mental abilities or inadequate experience and/or knowledge, provided that they are supervised or have been instructed on how to use the appliance safely and have understood the resulting dangers.

Do not let children play with the appliance. Children must not perform cleaning or user maintenance unless they are at least 15 years old and are being supervised.

Keep children under the age of 8 years away from the appliance and power cable.

#### 1.4 Safe use

Always place accessories in the cooking compartment the right way round.

→ "Accessories", Page 11

#### **⚠ WARNING – Risk of fire!**

Combustible objects that are left in the cooking compartment may catch fire.

- ▶ Never store combustible objects in the cooking compartment.
- ▶ If smoke is emitted, the appliance must be switched off or the plug must be pulled out and the door must be held closed in order to stifle any flames.

Loose food remnants, fat and meat juices may catch fire.

- ▶ Before using the appliance, remove the worst of the food residues and remnants from the cooking compartment, heating elements and accessories.

Opening the appliance door creates a draught. Greaseproof paper may come into contact with the heating element and catch fire.

- ▶ Never place greaseproof paper loosely over accessories when preheating the appliance and while cooking.
- ▶ Always cut greaseproof paper to size and use a plate or baking tin to hold it down.

#### **⚠ WARNING – Risk of burns!**

The appliance and its parts that can be touched become hot during use.

- ▶ Caution should be exercised here in order to avoid touching heating elements.
- ▶ Young children under 8 years of age must be kept away from the appliance.

Accessories and cookware get very hot.

- ▶ Always use oven gloves to remove accessories or cookware from the cooking compartment.

When the cooking compartment is hot, any alcoholic vapours inside may catch fire. The appliance door may spring open. Hot steam and jets of flame may escape.

- ▶ Only use small quantities of drinks with a high alcohol content in food.
- ▶ Do not heat spirits ( $\geq 15\%$  vol.) when undiluted (e.g. for marinating or pouring over food).
- ▶ Open the appliance door carefully.

#### **⚠ WARNING – Risk of scalding!**

The accessible parts of the appliance become hot during operation.

- ▶ Never touch these hot parts.
- ▶ Keep children at a safe distance.

Hot steam may escape when you open the appliance door. Steam may not be visible, depending on the temperature.

- ▶ Open the appliance door carefully.
- ▶ Keep children at a safe distance.

If there is water in the cooking compartment when it is hot, this may create hot steam.

- ▶ Never pour water into the cooking compartment when the cooking compartment is hot.

#### **⚠ WARNING – Risk of injury!**

Scratched glass in the appliance door may develop into a crack.

- ▶ Do not use any harsh or abrasive cleaners or sharp metal scrapers to clean the glass on the oven door, as they may scratch the surface.

The appliance and its parts that can be touched may have sharp edges.

- ▶ Take care when handling and cleaning them.
- ▶ If possible, wear protective gloves.

The hinges on the appliance door move when the door is opened and closed, which could trap your fingers.

- ▶ Keep your hands away from the hinges.

Components inside the appliance door may have sharp edges.

- ▶ Wear protective gloves.

#### **⚠ WARNING – Risk of electric shock!**

Improper repairs are dangerous.

- ▶ Repairs to the appliance should only be carried out by trained specialist staff.
- ▶ Only use genuine spare parts when repairing the appliance.
- ▶ If the power cord of this appliance is damaged, it must be replaced by trained specialist staff.

If the insulation of the power cord is damaged, this is dangerous.

- ▶ Never let the power cord come into contact with hot appliance parts or heat sources.
- ▶ Never let the power cord come into contact with sharp points or edges.
- ▶ Never kink, crush or modify the power cord.

An ingress of moisture can cause an electric shock.

- ▶ Do not use steam- or high-pressure cleaners to clean the appliance.

If the appliance or the power cord is damaged, this is dangerous.

- ▶ Never operate a damaged appliance.
- ▶ Never pull on the power cord to unplug the appliance. Always unplug the appliance at the mains.
- ▶ If the appliance or the power cord is damaged, immediately unplug the power cord or switch off the fuse in the fuse box.
- ▶ Call customer services. → Page 37

### **⚠ WARNING – Risk of suffocation!**

Children may put packaging material over their heads or wrap themselves up in it and suffocate.

- ▶ Keep packaging material away from children.
- ▶ Do not let children play with packaging material.

Children may breathe in or swallow small parts, causing them to suffocate.

- ▶ Keep small parts away from children.
- ▶ Do not let children play with small parts.

## **1.5 Steam**

Follow these instructions when using a steam function.

### **⚠ WARNING – Risk of scalding!**

The water in the water tank may become very hot if you operate the appliance for long periods.

- ▶ Always empty the water tank after using the steam function.

Hot steam is generated in the cooking compartment.

- ▶ Do not reach into the cooking compartment when using steam.

Hot liquid may spill over the sides of the accessory when it is removed from the cooking compartment.

- ▶ Remove hot accessories with care and always wear oven gloves.

### **⚠ WARNING – Risk of fire!**

Due to the hot surfaces, vapours from flammable liquids may catch fire in the cooking compartment (explosion). The appliance door may spring open. Hot steam and jets of flame may escape.

- ▶ Do not pour flammable liquids (e.g. alcoholic drinks) into the water tank.
- ▶ Only fill the water tank with water or with the descaling solution we have recommended.

## **1.6 Cleaning function**

### **⚠ WARNING – Risk of fire!**

Loose food remnants, fat and meat juices may catch fire when the cleaning function is in progress.

- ▶ Before you start the cleaning function, always remove coarse dirt from the cooking compartment.

- ▶ Never clean accessories at the same time.

The outside of the appliance gets very hot when the cleaning function is in progress.

- ▶ Never hang combustible objects, e.g. tea towels, on the door handle.

- ▶ Leave the front of the appliance clear.

- ▶ Keep children at a safe distance.

If the door seal is damaged, a large amount of heat is generated around the door.

- ▶ Do not scrub or remove the seal.

- ▶ Never operate the appliance if the seal is damaged or missing.

### **⚠ WARNING – Risk of serious harm to health!**

The appliance gets very hot when the cleaning function is in progress. The non-stick coating on baking trays and tins is destroyed and noxious gases are released.

- ▶ Never clean non-stick baking trays or baking tins using the cleaning function.

- ▶ Never clean accessories at the same time.

### **⚠ WARNING – Risk of harm to health!**

The cleaning function heats up the cooking compartment to a very high temperature so that food left over from roasting, grilling and baking will burn off. This process releases vapours, which can irritate mucous membranes.

- ▶ Keep the kitchen well ventilated while the cleaning function is running.

- ▶ Do not remain in the room for long periods.

- ▶ Keep children and pets away.

**⚠ WARNING – Risk of burns!**

The cooking compartment gets very hot when the cleaning function is in progress.

- ▶ Never open the appliance door.
- ▶ Allow the appliance to cool down.
- ▶ Keep children at a safe distance.

**⚠** The outside of the appliance gets very hot when the cleaning function is in progress.

- ▶ Never touch the appliance door.
- ▶ Allow the appliance to cool down.
- ▶ Keep children at a safe distance.

## 2 Preventing material damage

### 2.1 General

#### ATTENTION!

Alcoholic vapours may catch fire in the hot cooking compartment and cause permanent damage to the appliance. The appliance door may spring open due to an explosion and it may fall off. The door panels may shatter and fragment. Due to the resulting negative pressure, the cooking compartment may become considerably deformed inwards.

- ▶ Do not heat spirits ( $\geq 15\%$  vol.) when undiluted (e.g. for marinating or pouring over food).

If there is water on the cooking compartment floor when operating the appliance at temperatures above  $120\text{ }^{\circ}\text{C}$ , this will damage the enamel.

- ▶ Do not use the appliance if there is water on the cooking compartment floor.
- ▶ Wipe away any water on the cooking compartment floor before operation.

Objects on the cooking compartment floor at over  $50\text{ }^{\circ}\text{C}$  will cause heat to build up. The baking and roasting times will no longer be correct and the enamel will be damaged.

- ▶ Do not place any accessories, greaseproof paper or foil of any kind on the cooking compartment floor.
- ▶ Only place cookware on the cooking compartment floor if a temperature under  $50\text{ }^{\circ}\text{C}$  has been set.

When the cooking compartment is hot, any water inside it will create steam. The change in temperature may cause damage.

- ▶ Never pour water into the cooking compartment when it is still hot.
- ▶ Never place cookware containing water on the cooking compartment floor.

The prolonged presence of moisture in the cooking compartment leads to corrosion.

- ▶ Allow the cooking compartment to dry after use. To do this, open the cooking compartment door completely or use the drying function.
- ▶ Do not keep moist food in the cooking compartment for a long time with the door closed.
- ▶ Do not store food in the cooking compartment.
- ▶ Take care not to trap anything in the appliance door.

Fruit juice dripping from the baking tray leaves stains that cannot be removed.

- ▶ When baking very juicy fruit flans, do not pack too much on the baking tray.
- ▶ If possible, use the deeper universal pan.

Using oven cleaner in a hot cooking compartment damages the enamel.

- ▶ Never use oven cleaner in the cooking compartment when it is still warm.
- ▶ Remove all food remnants from the cooking compartment and the appliance door before you next heat up the appliance.

If the seal is very dirty, the appliance door will no longer close properly during operation. This may damage the front of adjacent kitchen units.

- ▶ Keep the seal clean at all times.
- ▶ Never operate the appliance if the seal is damaged or missing.

Sitting or placing objects on the appliance door may damage it.

- ▶ Do not place, hang or support objects on the appliance door.
- ▶ Do not place cookware or accessories on the appliance door.

With certain models, accessories may scratch the door pane when closing the appliance door.

- ▶ Always push accessories fully into the cooking compartment.

If aluminium foil comes into contact with the door pane, it could cause permanent discolouration.

- ▶ Do not allow aluminium foil in the cooking compartment to come into contact with the door pane.

### 2.2 Steam

Follow these instructions when using the steam function.

#### ATTENTION!

Silicone bakeware is not suitable for combined operation with steam.

- ▶ Cookware must be heat- and steam-resistant.

Using cookware with rust spots may cause corrosion in the cooking compartment. Even the smallest spots of rust can cause corrosion.

- ▶ Do not use cookware with rust spots.

Hot water in the water tank may damage the steam system.

- ▶ Only fill the water tank with cold water.

If there is water on the cooking compartment floor when operating the appliance at temperatures above  $120\text{ }^{\circ}\text{C}$ , this will damage the enamel.

- ▶ Do not use the appliance if there is water on the cooking compartment floor.
- ▶ Wipe away any water on the cooking compartment floor before operation.

If descaling solution comes into contact with the control panel or other delicate surfaces, it will damage them.

- ▶ Remove descaling solution immediately with water.

Cleaning the water tank in the dishwasher will damage it.

- ▶ Do not clean the water tank in the dishwasher.
- ▶ Clean the water tank with a soft cloth and standard washing-up liquid.

---

## 3 Environmental protection and saving energy

### 3.1 Disposing of packaging

The packaging materials are environmentally compatible and can be recycled.

- ▶ Sort the individual components by type and dispose of them separately.

### 3.2 Saving energy

If you follow these instructions, your appliance will use less power.

Only preheat the appliance if the recipe or the recommended settings tell you to do so.

→ *"How it works", Page 38*

- Not preheating the appliance can reduce the energy used by up to 20%.

Use dark-coloured, black-coated or enamelled baking tins.

- These types of baking tin absorb the heat particularly well.

Open the appliance door as little as possible during operation.

- This maintains the temperature in the cooking compartment and eliminates the need for the appliance to reheat.

When baking multiple dishes, do so in succession or in parallel.

- The cooking compartment is heated after baking the first dish. This reduces the baking time for the second cake.

If the cooking time is relatively long, you can switch the appliance off 10 minutes before the cooking time ends.

- There will be enough residual heat to finish cooking the dish.

Remove any accessories that are not being used from the cooking compartment.

- Accessories that are not being used do not need to be heated.

Allow frozen food to defrost before cooking.

- This saves the energy that would otherwise be required to defrost it.

Switch off the display in the basic settings.

→ *"Basic settings", Page 21*

- Energy is saved when the display is switched off.

#### **Note:**

The appliance requires:

- A maximum of 2 W in networked standby mode
- A maximum of 0.5 W in non-networked standby mode with the display switched off

## 4 Familiarising yourself with your appliance

### 4.1 Control panel

You can use the control panel to configure all functions of your appliance and to obtain information about the operating status.

On certain models, specific details such as colour and shape may differ from those pictured.

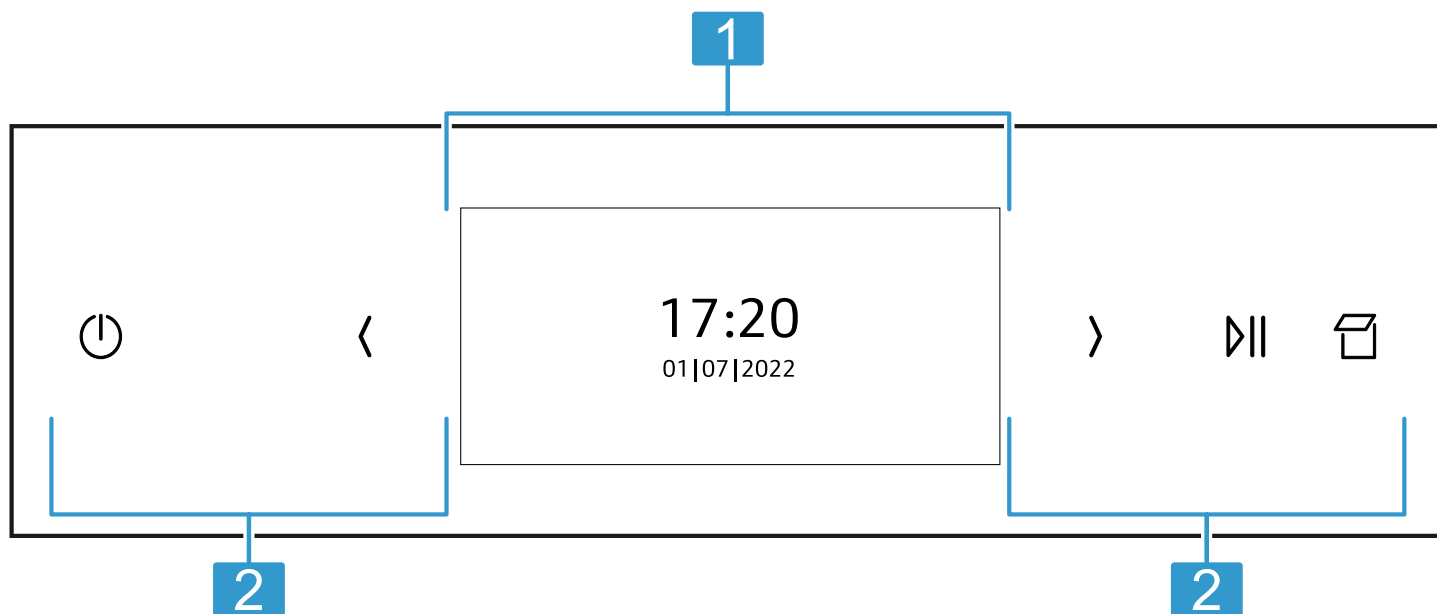

**1** Display  
→ "Display", Page 7

**2** Buttons  
→ "Buttons", Page 7

### 4.2 Display

You can configure all the functions on your appliance via the display.

The main menu provides an overview of your appliance's functions.

→ "Functions", Page 8

#### Navigating

Direction	Use
Navigate to the left	Swipe right on the display with your finger
Navigate to the right	Swipe left on the display with your finger

#### Setting values

To adjust a setting, touch the appropriate place on the display with your finger. The settings area appears on the display. Swipe left or right over this settings area on the display with your finger until the required setting is magnified.

Values	Use
Increase	Swipe right on the display with your finger
Decrease	Swipe left on the display with your finger

### 4.3 Buttons

The buttons are touch-sensitive areas. To select a function, press the corresponding button.

Symbol	Name	Use
⏻	On/Off	Switch the appliance on or off
<	Left arrow	Decreases the adjustment values
>	Right arrow	Increases the adjustment values

Symbol	Name	Use
	Start/stop	Start or pause the appliance
	Open control panel	Fill or empty the water tank

## 4.4 Cooking compartment

Various functions in the cooking compartment provide support when operating your appliance.

### Shelf supports

The shelf supports in the cooking compartment enable you to place accessories at different heights.

→ "Accessories", Page 11

Your appliance has 4 shelf positions. The shelf positions are numbered from bottom to top.

You can remove the shelf supports, e.g. for cleaning.

→ "Rails", Page 29

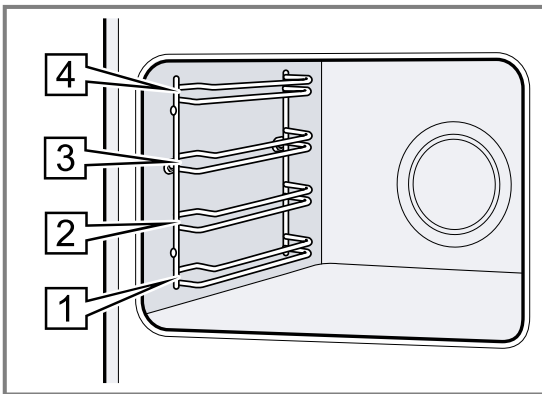

### Lighting

One or more oven lights illuminate the cooking compartment.

When you open the appliance door, the light in the cooking compartment switches on. If the appliance door remains open for longer than 15 minutes, the light switches off again.

For most functions, the lighting is switched on during operation. The lighting switches off again when the operation ends.

### Cooling fan

The cooling fan switches on and off depending on the appliance's temperature. The hot air escapes above the door.

### ATTENTION!

Covering the ventilation slots will cause the appliance to overheat.

► Do not cover the ventilation slots.

To ensure that the appliance cools down more quickly after operation, the cooling fan continues to run for a certain period afterwards.

### Appliance door

If you open the appliance door during operation, the operation stops. If you close the appliance door, operation resumes automatically.

### Water tank

You need the water tank for the types of steam heating. The water tank is behind the control panel.

→ "Filling the water tank", Page 15

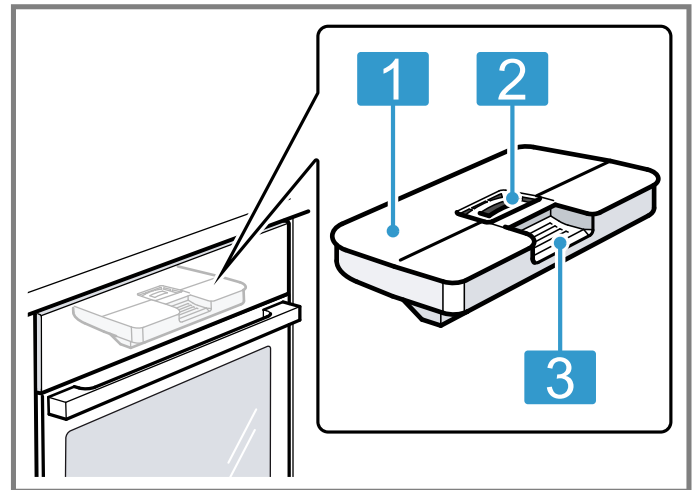

- 1** Tank cover
- 2** Opening for filling and emptying
- 3** Handle for removing and inserting







## 5 Functions

The main menu provides an overview of your appliance's functions.

**Tip:** Depending on the appliance type, additional or more comprehensive functions are available to you with the Home Connect app. You can find more information about this in the app.

Function	Name	Use
	Types of heating	Select the required type of heating and temperature for your food
	Steam	Prepare food with types of steam heating → "Steam", Page 14
	Favourites	Select saved favourites → "Favourites", Page 20
	Dishes	Use programmes or recommended settings for various types of food → "Dishes", Page 18















Function	Name	Use
	Cleaning	<ul style="list-style-type: none"> <li>■ Pyrolytic self-cleaning  cleans the cooking compartment almost by itself → "Pyrolytic self-cleaning cleaning function", Page 25</li> <li>■ Easy Clean  removes light dirt from the cooking compartment → "Easy Clean cleaning aid", Page 27</li> <li>■ Drying function  dries the cooking compartment → "Drying", Page 28</li> <li>■ Descaling  keeps your appliance working properly → "Descaling", Page 27</li> </ul>
	Basic settings	Individually adjust the appliance settings → "Basic settings", Page 21

## 5.1 Heating functions

This is where you will find an overview of the types of heating. You will find recommendations for using the types of heating.



For temperatures above 275 °C, the appliance reduces the temperature to approx. 275 °C after around 40 minutes.

Symbol	Heating function	Temperature	Use
	Circo Therm hot air	30 - 230 °C	Bake or roast on one or more levels. The fan distributes the heat from the ring-shaped heating element in the back wall evenly around the cooking compartment.
	Top/bottom heat	30 - 275 °C	Traditionally bake or roast on one level. This type of heating is especially good for cakes with moist toppings. The heat is emitted evenly from above and below.
	Circo Therm gentle	125 - 230 °C	For gently cooking selected types of food on one level without preheating. The fan distributes the heat from the ring-shaped heating element in the back wall around the cooking compartment. The food is cooked in phases using residual heat. Always keep the appliance door closed when cooking. The food is cooked in phases using residual heat. Always keep the appliance door closed when cooking. If you open the appliance door even briefly, the appliance will continue to heat without utilising any residual heat. This type of heating is used to determine the energy consumption in circulating-air mode and the energy efficiency class.
	Top/bottom heat gentle	150 - 250 °C	For gently cooking selected types of food without preheating. Heat is emitted from above and below. This type of heating is used to determine the energy consumption in the conventional mode.
	Circo-roasting	30 - 275 °C	Roast poultry, whole fish or larger pieces of meat. The grill element and the fan switch on and off alternately. The fan circulates the hot air around the food.
	Pizza setting	30 - 275 °C	Cook pizza or food that requires a lot of heat from below. The bottom heating element and the ring-shaped heating element in the back wall heat the cooking compartment.
	Bread baking setting	180 - 275 °C	For baking bread, bread rolls and baked goods that require high temperatures.
	Full-surface grill	50 - 290 °C	For grilling flat items such as steaks, sausages or bread, and for cooking au gratin. The entire area below the grill element becomes hot.
	Centre-area grill	50 - 290 °C	For grilling small amounts of steaks, sausages or bread, and for cooking au gratin. The central area below the grill element becomes hot.
	Bottom heat	30 - 250 °C	For cooking in a bain marie and for baking food for extra time. The heat is emitted from below.
	Low-temperature cooking	70 - 120 °C	For gentle, slow cooking of seared, tender pieces of meat in cookware without a lid. The heat is emitted evenly from above and below at a low temperature.

Symbol	Heating function	Temperature	Use
	Plate warming	30 - 90 °C	For heating cookware.
	Keep warm	50 - 100 °C	For keeping cooked food warm.

## 5.2 Types of steam heating





This is where you can find an overview of the types of steam heating. You will find recommendations for using the types of steam heating.

Symbol	Type of heating	Temperature	Use
	Reheat	80 - 180 °C	For gently reheating food or for crisping up baked goods.
	Dough proving	30 - 50 °C	For proving dough and culturing yoghurt. Dough will prove more quickly than at room temperature. The surface of the dough does not dry out.

## 5.3 Additional options













You can find an overview of other options here.

To display the options, press  :

Symbol	Name	Use
	Lighting	Switch the lighting in the cooking compartment on or off
	Timer	Set the timer
	Childproof lock	Activate the childproof lock
	Remote start	Activate remote start → "Home Connect ", Page 22

## 5.4 Symbols

You can find an overview of other symbols on the display here.

Symbol	Name	Use
	SaveSave	Save the setting
	Back	Navigate back
	Close	Close the message
	Reset	Reset the cooking time
	Reset	Reset the values
	Information	Display information
	Rapid heating	Activate or deactivate the rapid heating function
	Home Connect	<ul style="list-style-type: none"> <li>■ Home network and Home Connect server connected</li> <li>■ The number of lines shows the signal strength of the home network</li> </ul> → "Home Connect ", Page 22
	Home network	Home network not connected → "Home Connect ", Page 22
	Home Connect server	Home Connect server not connected → "Home Connect ", Page 22
	Remote Diagnostics	Remote diagnostics activated → "Home Connect ", Page 22
	Descal reminder	Number of operations with steam until the next descaling phase → "Descaling", Page 27

## 6 Accessories

Use original accessories. These have been made especially for your appliance.

**Note:** Accessories may become deformed if they get hot. Deformation has no effect on function. As the accessory cools down, it will regain its original shape.

The accessories supplied may differ depending on the appliance model.

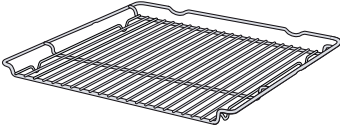
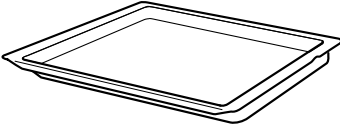
Accessories		Use
Wire rack		<ul style="list-style-type: none"> <li>■ Cake tins</li> <li>■ Ovenproof dishes</li> <li>■ Cookware</li> <li>■ Meat, e.g. roasting joints or steak</li> <li>■ Frozen meals</li> </ul>
Universal pan		<ul style="list-style-type: none"> <li>■ Moist cakes</li> <li>■ Baked items</li> <li>■ Bread</li> <li>■ Large roasts</li> <li>■ Frozen meals</li> <li>■ Catch dripping liquids, e.g. fat when grilling food on the wire rack.</li> </ul>

### 6.1 Locking function

The locking function prevents the accessories from tilting when they are pulled out.

You can pull out the accessories approximately halfway without them tipping. The accessories must be inserted into the cooking compartment correctly for the tilt protection to work properly.

### 6.2 Sliding accessories into the cooking compartment

Always slide the accessory into the cooking compartment the right way round. This is the only way to ensure that accessories can be pulled out approximately halfway without tipping.

1. Turn the accessories so that the notch  is at the rear and is facing downwards.
2. Insert the accessory between the two guide rods for a shelf position.

Wire rack Insert the wire rack with the open side facing the appliance door.

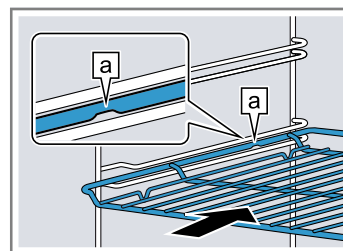

Tray  
E.g. universal pan or baking tray Slide the tray in with the sloping edge  towards the appliance door.

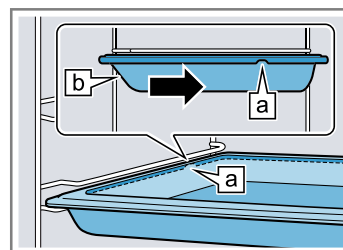

3. Push the accessory all the way in, making sure that it does not touch the appliance door.

**Note:** Take any accessories that you will not be using out of the cooking compartment while the appliance is in operation.

### Combining accessories

You can combine the wire rack with the universal pan to catch any liquid that drips down.

1. Place the wire rack on the universal pan so that both spacers  are on the rear edge of the universal pan.
2. Insert the universal pan between the two guide rods for a shelf position. In so doing, the wire rack is on top of the upper guide rod.

en Before using for the first time

Wire rack  
on univer-  
sal pan

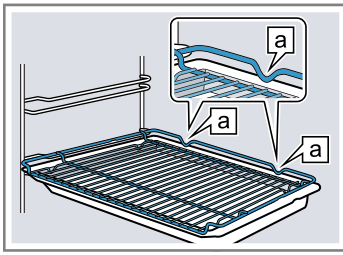

## 6.3 Other accessories

You can purchase other accessories from our customer service, specialist retailers or online. You will find a comprehensive range of products for your appliance in our brochures and online: [www.neff-home.com](http://www.neff-home.com)

Accessories are appliance-specific. When purchasing accessories, always quote the exact product number (E no.) of your appliance.

You can find out which accessories are available for your appliance in our online shop or from our customer service.

# 7 Before using for the first time

Configure the settings for initial start-up. Clean the appliance and accessories.

## 7.1 Determining the water hardness before switching on the appliance for the first time

Before using the appliance for the first time, ask your water supplier about the hardness of your tap water. To ensure that the appliance can reliably remind you to descale it when required, you must set your water hardness range correctly.

### ATTENTION!

If the wrong water hardness has been set, the appliance cannot remind you to descale it at the right time.

- ▶ Set the water hardness correctly.
- Using unsuitable liquids may damage the appliance.
- ▶ Do not use distilled water or other liquids.
  - ▶ Only use cold, fresh tap water, softened water or non-carbonated mineral water.

Malfunctions may occur when using filtered or demineralised water. The appliance may request that you top up the water tank even though it may be full, or operation with steam is cancelled after approx. two minutes.

- ▶ If required, mix filtered or demineralised water with the bottled non-carbonated mineral water with a ratio of one to one.

### Notes

- If you are using mineral water, set the water hardness range to "very hard". If you are using mineral water, you must only use non-carbonated mineral water.
- If your tap water is very hard, we recommend that you use softened water. If you are using only softened water, set the "softened" water hardness range.

Setting	Water hardness in mmol/l	German hardness °dH	French hardness °fH
0 (softened) <sup>1</sup>	-	-	-
1 (soft)	Up to 1.5	Up to 8.4	Up to 15
2 (medium)	1.5-2.5	8.4-14	15-25
3 (hard)	2.5-3.8	14-21.3	25-38
4 (very hard) <sup>2</sup>	Over 3.8	Over 21.3	Over 38

<sup>1</sup> Only set this if you will be using solely softened water.

<sup>2</sup> Also set for mineral water. Only use non-carbonated mineral water.

## 7.2 Initial use

After connecting the appliance to the power supply, you must configure the settings for its initial start-up. It may take a few minutes for the settings to appear on the display.

### Notes

- You can adjust the settings at any time in the basic settings.  
→ "Basic settings", Page 21
- You can also use Home Connect to configure the settings. When your appliance is connected, follow the instructions in the app.  
→ "Home Connect ", Page 22

## Setting the language

**Requirement:** The appliance is connected to the power supply.

1. Press  to switch the appliance on.
2. Use the < or > button to select the language.
3. Press the required language.
4. Press → to confirm the language.

## Setting up Home Connect

**Note:** You can skip Home Connect set-up by pressing "Later". Next, set the clock.

1. Press "Connect" to set up Home Connect.
2. Make all other settings for initial start-up in the Home Connect app.

## Setting the time

1. Use < or > to select the hours.
2. Press the minutes.
3. Use < or > to select the minutes.
4. Press ✓ to confirm the time.

## Setting the date

1. Use < or > to select the year.
2. Press the month.
3. Use < or > to select the month.
4. Press the day.
5. Use < or > to select the day.
6. Press ✓ to confirm the date.

## Setting the water hardness

1. Use < or > to select the water hardness range.  
→ "Determining the water hardness before switching on the appliance for the first time", Page 12
2. Press ✓ to confirm the water hardness range.
3. Press "OK" to end the initial start-up.
4. Open and close the appliance door once.  
✓ The appliance will perform a self-test, after which it will be ready to use.  
✓ The initial start-up is now complete.



## 7.3 Cleaning the appliance

Before using the appliance to cook food for the first time, you must clean the cooking compartment and accessories.

1. Remove the product information, accessories and any leftover packaging (e.g. polystyrene pellets) from the cooking compartment.

2. Wipe the smooth surfaces in the cooking compartment with a soft, damp cloth.
3. Press ⏻ to switch the appliance on.  
→ "Switching on the appliance", Page 13
4. Fill the water tank.  
→ "Filling the water tank", Page 15
5. Set the required type of heating, temperature and steam assistance for the heat-up process and press ▶▶ to start.  
→ "Setting the type of heating and temperature", Page 13  
→ "Added steam", Page 16

### Heating up

Type of heating	Circo Therm hot air  with steam assistance  , steam intensity High
Temperature	Maximum
Cooking time	1 hour

6. Ventilate the kitchen while the appliance is heating.
7. Press ⏻ to switch off the appliance after 1 hour.  
→ "Switching off the appliance", Page 13
8. Allow the appliance to cool down.
9. Clean the smooth surfaces with soapy water and a dish cloth.
10. Empty the water tank and dry the cooking compartment.  
→ "After using steam operation", Page 17
11. Thoroughly clean any accessories you used with soapy water and a dish cloth.

# 8 Basic operation

## 8.1 Switching on the appliance

### ATTENTION!

If there is water on the cooking compartment floor when operating the appliance at temperatures above 120 °C, this will damage the enamel.

- ▶ Do not use the appliance if there is water on the cooking compartment floor.
- ▶ Wipe away any water on the cooking compartment floor before operation.
- ▶ Press ⏻ to switch the appliance on.

### Notes

- In the basic settings, you can specify whether the display shows the main menu or another function when the appliance is switched on.  
→ "Basic settings", Page 21
- If you do not perform any actions on the appliance for an extended period, it will automatically switch itself off.

## 8.2 Switching off the appliance

- ▶ Press ⏻ to switch the appliance off.

### Notes

- The residual heat indicator will appear on the display while the cooking compartment is still hot.  
→ "Residual heat indicator", Page 13

- The cooling fan will continue to run until the cooking compartment has cooled down.  
→ "Cooling fan", Page 8

## 8.3 Residual heat indicator

After you have switched off the appliance, the residual heat indicator will appear on the display.

Display	Temperature
Residual heat high	Over 120 °C
Residual heat low	Between 60 and 120 °C

## 8.4 Setting the type of heating and temperature

1. Press ⏻ to switch the appliance on.
2. Press "Types of heating".
3. Scroll through the types of heating using < or >.
4. Press the type of heating that you want to use.
5. Press "Temperature".
6. Use < or > to select the temperature.
7. Press ✓ to confirm the setting.  
Also available to select:
  - Rapid heating → Page 20
  - Cooking time → Page 18
  - Ready at → Page 18

- Added steam → *Page 16*
  - Information → *Page 14*
8. Press  $\triangleright$  to start the operation.
    - ✓ The cooking time appears on the display.
    - ✓ For some types of heating, the heat-up indicator can be viewed in the preheating phase. The optimal time to place your food in the cooking compartment is as soon as the heat-up indicator is filled.
  9. When the food is ready, use  $\odot$  to switch the appliance off.

## 8.5 Changing the temperature

You can also change the temperature or level once you have started the appliance.

1. Press "Temperature".
2. Use  $\langle$  or  $\rangle$  to change the temperature.
3. Press  $\checkmark$  to confirm the setting.
- ✓ The temperature is changed.

## 8.6 Changing the type of heating

If you switch to a different type of heating, the appliance will reset all the settings.

1. Press  $\triangleright$  to pause operation.
2. Press  $\leftarrow$  to switch to the types of heating.
3. Scroll through the types of heating using  $\langle$  or  $\rangle$ .
4. Press the type of heating that you want to use.
5. Adjust the temperature or level, if required.
6. Press  $\triangleright$  to start the operation.

## 8.7 Pausing operation

1. Press  $\triangleright$ .
2. Press  $\triangleright$  again to resume operation.

## 8.8 Displaying information

**Note:** In most cases, you can call up information about the function that you have just started.

1. Press "Information".
- ✓ The information will be displayed for a few seconds.
2. Press  $\times$  to close the information.

## 8.9 Keeping warm over an extended period

You can use your appliance to keep meals warm for up to 24 hours without changing the behaviour of the appliance. Use the time functions and change the basic settings.

**Note:** If you open the appliance door during operation, the appliance stops heating. When you close the appliance door, the appliance continues to heat again. To ensure that the behaviour of the appliance is not changed during operation, only open the appliance door once the set time has elapsed.

1. Change the basic settings.
  - *"Basic settings", Page 21*
  - Change the "Lighting" basic setting to "Always off".
  - Change the "Standby screen" basic setting to "On".
  - Change the "Signal tone" basic setting to "Very short duration".
  - ✓ This will ensure that the light in the cooking compartment is always off while the appliance is in operation and when you open the appliance door. The clock display does not change. The duration of the signal tone is reduced at the end of the operation.
2. Set the required operating mode.
  - *"Heating functions", Page 9*
3. Set the required cooking time depending on the operating mode.
  - *"Setting the cooking time", Page 18*
  - *"Time-setting options", Page 17*
4. Use "End" to set the time at which the operation should end.
  - *"Setting the "Ready at" time for delayed starts", Page 18*
  - *"Time-setting options", Page 17*
5. Place the food in the cooking compartment before the appliance starts to heat.
6. Press  $\triangleright$  to start the operation.
  - ✓ The display shows the time remaining until the operation starts. The appliance is in standby mode.
  - ✓ Once the start time has been reached, the appliance starts heating and the cooking time starts counting down.
7. When the operation has ended, remove the food from the cooking compartment. The appliance automatically switches off completely after approximately 15 to 20 minutes.

**Note:** If required, change the different basic settings again.

---

# 9 Steam

Food can be cooked particularly gently using steam. You can use the special types of steam heating, or use steam assistance with certain types of heating.

### **WARNING – Risk of scalding!**

Hot steam may escape when you open the appliance door. Steam may not be visible, depending on the temperature.

- ▶ Open the appliance door carefully.
- ▶ Keep children at a safe distance.

## 9.1 Before using the steam function

Before using the steam function each time, make sure that your appliance is supplied with sufficient water.

## Filling the water tank

### ⚠ WARNING – Risk of fire!

Due to the hot surfaces, vapours from flammable liquids may catch fire in the cooking compartment (explosion). The appliance door may spring open. Hot steam and jets of flame may escape.

- ▶ Do not pour flammable liquids (e.g. alcoholic drinks) into the water tank.
- ▶ Only fill the water tank with water or with the descaling solution we have recommended.

### ⚠ WARNING – Risk of burns!



The water tank may heat up while the appliance is in operation.

- ▶ Wait until the water tank has cooled down from the previous operation.
- ▶ Remove the water tank from the tank recess.

**Requirement:** The water hardness is set correctly.

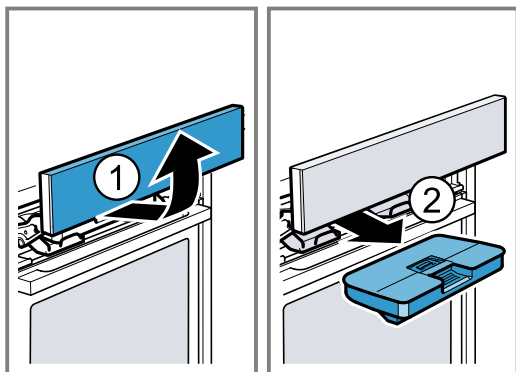
1. Press .
- ✓ The control panel pops out automatically.
2. Pull the control panel towards you with both hands and then push it upwards until it clicks into place ①.
3. Remove the water tank from the tank recess ②.



4. Press down on the water tank lid along the seal to prevent water from leaking out of the water tank.
5. Remove the cover  on the water tank.
6. Fill the water tank with water up to the "max"  mark.

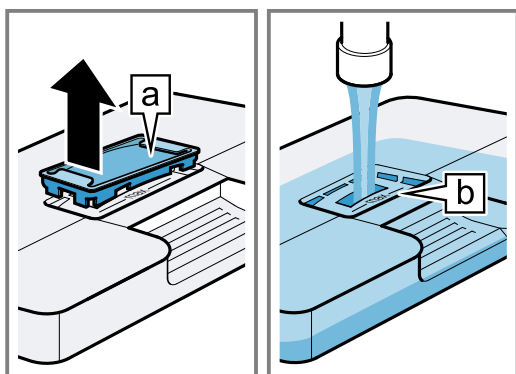

7. Put the cover back into the opening on the water tank.

8. Insert the full water tank ①. When doing so, make sure that the water tank clicks into place behind the retainers .

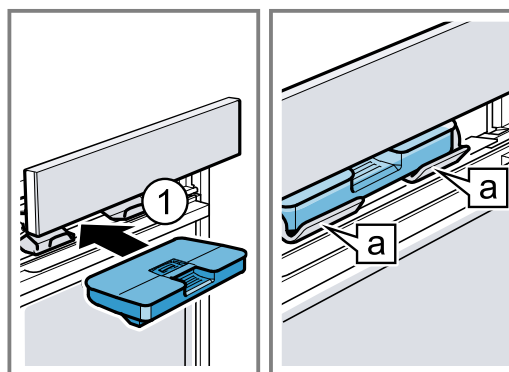

9. Slowly slide the control panel downwards and then push it away from you until it is closed completely.

## Refilling the water tank

When "Fill water tank" appears on the display, you must refill the water tank.

### Notes

- Dough proving and Reheat functions: If you do not refill the water tank, the appliance will stop. Refill the water tank.
- Added steam and steam boost: If you do not refill the water tank, the appliance continues to run without added steam or steam boost.

1. Open the control panel.
2. Remove and refill the water tank.
3. Insert the full water tank and close the control panel.

## 9.2 Steam heating functions











Your appliance has several types of steam heating.  
→ "Types of steam heating", Page 10

### Reheat

"Reheat" can be used to warm up food that has already been cooked, or bread and pastries from the day before, without affecting their quality.

### Configuring the Reheat heating function

**Requirement:** The cooking compartment has cooled down sufficiently.

1. Fill the water tank.  
→ "Filling the water tank", Page 15
2. Press  to switch the appliance on.
3. Press "Steam".
4. Use  or  to select reheating.
5. Press "Reheat".
6. Press "Temperature".
7. Use  or  to select the temperature.
8. Press  to confirm the setting.
9. Press "Cooking time".
10. Use  or  to select the duration.
11. Press  to confirm the setting.
12. Press  to start the reheating process.  
→ "Pausing operation", Page 14
- ✓ If the water tank runs dry during the reheating process, the operation is paused.  
→ "Refilling the water tank", Page 15
- ✓ Once the duration has elapsed, an audible signal sounds and the appliance stops heating.  
→ "Switching off the appliance", Page 13











13. Press any button to end the signal tone.
14. Empty the water tank and dry the cooking compartment.  
→ "After using steam operation", Page 17

### Dough proving

Yeast dough proves considerably more quickly using "Dough proving" than at room temperature, and it will not dry out.

#### Configuring the Dough proving heating function

**Requirement:** The cooking compartment must have cooled down completely (to room temperature).





1. Fill the water tank.  
→ "Filling the water tank", Page 15
2. Press  to switch the appliance on.
3. Press "Steam".
4. Use  or  to select dough proving.
5. Press "Dough proving".
6. Press "Temperature".
7. Use  or  to select the temperature.
8. Press  to confirm the setting.
9. Press "Cooking time".
10. Use  or  to select the cooking time.
11. Press  to confirm the setting.
12. Press  to start the dough proving process.  
→ "Pausing operation", Page 14
- ✓ If the water tank runs dry during the dough proving process, the operation is paused.  
→ "Refilling the water tank", Page 15
- ✓ Once the duration has elapsed, an audible signal sounds and the appliance stops heating.  
→ "Switching off the appliance", Page 13
13. Press any button to end the signal tone.
14. Empty the water tank and dry the cooking compartment.  
→ "After using steam operation", Page 17

### 9.3 Added steam

When you cook with added steam, the appliance introduces steam into the cooking compartment at various intervals. This gives your food a crispy crust and a glossy surface. Meat stays juicy, tender and only undergoes a minimum reduction in volume.



#### Types of heating and functions for added steam



You can switch on added steam for the following types of heating and functions:

- "Circo Therm hot air" 
- "Top/bottom heat" 
- "Circo-roasting" 
- "Bread baking setting" 
- "Keep warm" 
- → "Dishes", Page 18



#### Switching on added steam

1. Fill the water tank.  
→ "Filling the water tank", Page 15
2. Press  to switch the appliance on.
3. Set a suitable type of heating.  
→ "Types of heating and functions for added steam", Page 16
4. Set the required temperature.
5. Press "Added steam".
6. Press the required steam intensity:



Symbol	Added steam
	"Low" (Setting 1)
	"Medium" (Setting 2)
	"High" (Setting 3)

7. Press  to confirm the setting.
8. Press  to start operation with added steam.
- ✓ If the water tank runs dry during the added steam process, "Fill water tank" appears on the display. The appliance continues to operate without added steam.  
→ "Refilling the water tank", Page 15
9. When the food is ready, use  to switch the appliance off.
10. Empty the water tank and dry the cooking compartment.  
→ "After using steam operation", Page 17

#### Changing added steam

1. Press .
2. Press "Added steam".
3. Press the required steam intensity.
4. Press  to confirm the setting.

#### Canceling added steam

1. Press .
2. Press "Added steam".
3. Press  "Off".
4. Press  to confirm the setting.
- ✓ The operation continues without adding steam.





### 9.4 Steam jet

You can use "Steam boost" to specifically add intensive steam at various intervals. This makes bread and bread rolls in particular wonderfully crispy and gives them a golden colour.



The appliance adds clouds of steam to the cooking compartment for approximately 3 to 5 minutes. Depending on the operation, you can activate the steam boost several times.

#### Types of heating and functions for steam boost

You can switch on steam boost for the following types of heating and functions:



- "Circo Therm hot air" 
- "Top/bottom heat" 
- "Circo-roasting" 
- "Bread baking setting" 

#### Switching on steam boost

1. Fill the water tank.  
→ "Filling the water tank", Page 15
2. Press  to switch the appliance on.
3. Set a suitable type of heating.  
→ "Types of heating and functions for steam boost", Page 16
4. Set a temperature above 120 °C.
5. Press "Steam boost".
6. Press  to start operation with steam boost. Once  lights up, the water is heated up sufficiently to use the steam boost. Do not use the steam jet until the appliance has completely heated up.



**Note:** If rapid heating  is activated, the steam jet can only be triggered once rapid heating is complete.

7. Press  at the desired time.
- ✓ The steam jet is triggered and the appliance adds clouds of steam to the cooking compartment for approx. 3 to 5 minutes.
- ✓ When the steam boost has finished, the operation continues to run. Depending on the operation, the steam jet can be triggered again if necessary.
- ✓ If the water tank runs dry during steam boost, "Fill water tank" appears on the display. The operation continues without steam boost.  
→ "Refilling the water tank", Page 15
8. When the food is ready, use  to switch the appliance off.
9. Empty the water tank and dry the cooking compartment.  
→ "After using steam operation", Page 17

## 9.5 After using steam operation

Dry the appliance after each steam operation.

**Note:** Traces of limescale may remain in the cooking compartment after operation with steam. The functionality of the appliance is not affected by this. You can remove traces of limescale using hot water or a cloth soaked in vinegar. Observe the information on cleaning.

→ "Cleaning and servicing", Page 24

## Emptying the water tank

### WARNING – Risk of burns!

The water tank may heat up while the appliance is in operation.

- ▶ Wait until the water tank has cooled down from the previous operation.
- ▶ Remove the water tank from the tank recess.

### ATTENTION!

Drying the water tank in the hot cooking compartment leads to damage to the water tank.

- ▶ Do not dry the water tank in the hot cooking compartment.

Cleaning the water tank in the dishwasher will damage it.

- ▶ Do not clean the water tank in the dishwasher.
- ▶ Clean the water tank with a soft cloth and standard washing-up liquid.

1. Use  to open the control panel.
2. Remove the water tank.
3. Carefully remove the lid of the water tank.
4. Empty the water tank, clean it with detergent and then rinse it thoroughly with clean water.
5. Dry all parts with a soft cloth.
6. Rub the seal on the lid until dry.
7. Leave the water tank to dry with the lid open.
8. Place the lid on the water tank and push down on it.
9. Insert the water tank and close the control panel.



## Drying the cooking compartment

Dry the cooking compartment after each steam operation.

- ▶ Dry the cooking compartment by hand or use the drying function.  
→ "Drying", Page 28

# 10 Time-setting options

Your appliance has different time-setting options, with which you can control its operation.





Time-setting option	Use
Timer 	You can set the timer to run independently of the appliance during operation. The timer does not affect the appliance.
Cooking time 	Once the set duration has elapsed, the appliance stops heating automatically.
Ready at 	Along with the duration, you can set the time at which you want the operation to end. The appliance starts up automatically so that the operation finishes at the required time.

## 10.1 Timer







You can set the timer regardless of whether the appliance is on or off.

### Setting the timer





1. Press .

2. Press .
3. Press Hours, Minutes or Seconds.
4. Use  or  to select the timer duration.
5. Press  to confirm the setting.
- ✓  appears on the display. The timer counts down.
- ✓ Once the timer duration has elapsed, an audible signal sounds.
6. Press any button to end the audible signal.

### Changing the timer

1. Press .
2. Press .
3. Press .
4. Press Hours, Minutes or Seconds.
5. Use  or  to change the timer duration.
6. Press  to confirm the setting.

### Cancelling the timer

1. Press .
2. Press .
3. Press  to reset the timer duration.
4. Press  to close the timer.

## 10.2 Cooking time

Once the set duration has elapsed, the appliance stops heating automatically. You can only use the cooking time in conjunction with a type of heating.

### Setting the cooking time

1. Set a type of heating and a temperature.
2. Press "Cooking time".
3. Press Hours or Minutes.
4. Use < or > to select the cooking time.
5. Press ✓ to confirm the setting.
6. Press ▷|| to start operation with a cooking time.
  - ✓ The cooking time appears on the display. The cooking time counts down.
  - ✓ When the time has elapsed, a signal sounds.
7. Press any button to end the audible signal.

### Changing the cooking time

1. Press ^.
2. Press "Cooking time".
3. Use < or > to change the cooking time.
4. Press ✓ to confirm the setting.

### Cancelling the cooking time

1. Press ^.
2. Press "Cooking time".
3. Reset the cooking time using ↶.
4. Press ✓ to confirm the setting.

## 10.3 Delayed start/"Ready at" time

With this function, the appliance automatically switches itself on, and then switches itself off at the preselected end time. To enable it to do this, you set the cooking time (duration) and specify when you want your food to be ready. You can only use the delayed start function in conjunction with a heating function.

## Setting the "Ready at" time for delayed starts

### Notes

- Do not leave food that spoils easily in the cooking compartment for too long.
  - You cannot use the delayed start function with every type of heating.
1. Place the food into the cooking compartment and close the appliance door.
  2. Set a type of heating and a temperature.
  3. Press "Cooking time".
  4. Press Hours or Minutes.
  5. Use < or > to select the cooking time.
  6. Press ✓ to confirm the setting.
  7. Press "Ready at".
    - ✓ The time at which your food will be ready will appear on the display.
  8. Use the > button to select the required end time.
  9. Press ✓ to confirm the setting.
  10. Press ▷|| to confirm the delayed start.
    - ✓ The appliance will start at the appropriate time.
    - ✓ When the time has elapsed, a signal sounds.
  11. Press any button to end the audible signal.

### Changing the "Ready at" time for delayed starts

1. Press ▷||.
2. Press "Ready at".
3. Use < or > to change the end time.
4. Press ✓ to confirm the setting.
5. Press ▷|| to confirm the delayed start.

### Cancelling the "Ready at" time for delayed starts

1. Press ▷||.
2. Press "Ready at".
3. Use ↶ to reset the end time.
4. Press ✓ to confirm the setting.
  - ✓ The end time corresponds to the current time plus the set cooking time.
  - ✓ Press ▷|| to start operation with a cooking time.

**Note:** If you want to continue the operation without a cooking time, cancel the cooking time.

→ "Cancelling the cooking time", Page 18

# 11 Dishes

"Dishes" helps you to use your appliance to prepare different dishes by selecting the optimum settings automatically.

## 11.1 Cookware for dishes

The cooking result depends on the composition of the meat and the size of cookware.

You should therefore use heat-resistant cookware that is suitable for temperatures up to 300 °C. Glass or glass ceramic cookware is best. The joint should cover approx. 2/3 of the cookware base.

Cookware made from the following material is not suitable:

- Bright, shiny aluminium
- Unglazed clay
- Plastic or plastic handles

## 11.2 Setting options for the dishes

To cook the dishes perfectly, the appliance uses different settings depending on the dish.

The display shows you the settings that are used. You can adjust certain settings. Follow the instructions on the display.

**Note:** The cooking result depends on the quality and composition of the food. Use fresh and, ideally, chilled food. Use frozen food straight from the freezer.

### Tips and information about the settings

If you set a dish, the display shows relevant information for this dish, e.g.:

- Suitable shelf position
- Suitable accessory or cookware
- Added liquid
- Time for turning or stirring

When this time is reached, a signal sounds.

To call up the information, press "Information". Some notifications are displayed automatically.

## Programmes

The optimum type of heating, temperature and cooking time are preset for programmes.

To achieve an optimal cooking result, you must also set the weight, thickness or the cooking level. You can set the weight only in the intended range.

Unless otherwise indicated, set the total weight for your dish.

## Recommended settings

For the recommended settings, the optimum type of heating is preset as a fixed value. You can adjust the set temperature and the cooking time.

## Dishes with steam

For some dishes, you can select a cooking method with steam . The food is cooked gently.

Observe the information on operating with steam.

→ "Steam", Page 14

## 11.3 Overview of the dishes

You can see which individual dishes are available to you on the appliance. The dishes depend on the features of your appliance.

The dishes are sorted by category and food.

**Note:** In the basic settings, you can regionally specialise the displayed dishes.

→ "Basic settings", Page 21

Category	Food
Cakes	Cakes in tins Cakes on a baking tray Small baked items Biscuits
Bread, bread rolls	Bread Bread rolls
Pizza, savoury cakes, quiche	Pizza Savoury cakes, quiche
Bakes, soufflés	Bake, savoury, fresh, cooked ingredients Potato gratin, raw ingredients, 4 cm deep Lasagne, fresh Lasagne, chilled Bake, sweet, fresh Fruit crumble Soufflés in individual moulds Yorkshire pudding
Poultry	Chicken Duck, goose Turkey
Meat	Pork Beef Veal Lamb Game Meat dishes

Category	Food
Fish.	Fish, whole Fish fillets
Frozen products	Pizza Bakes Potato products Poultry, fish Bread rolls
Side dishes, vegetables	Potatoes Vegetables
Reheating, crisping up	Baked items Side dishes Vegetables Menu

## 11.4 Setting a dish

1. Press "Dishes".
2. Press the required category.
3. Press the required food.
4. Press the required dish.



**Note:** The setting options vary depending on the dish.

→ "Setting options for the dishes", Page 18





- ✓ The settings for the dish appear on the display.
- 5. Adjust the settings if required.  
The setting options vary depending on the dish.  
→ "Setting options for the dishes", Page 18
- 6. For information about the accessory and shelf position, for example, press "Information".
- 7. Press  to start the operation.
- ✓ The appliance starts to heat and the cooking time counts down.
- ✓ Once the dish is ready, a signal sounds. The appliance stops heating.
- 8. Decide how you want to continue:

Finish	Dish is ready
Add extra cooking time	→ "Extending the cooking time", Page 19
Keep warm	→ "Keeping a dish warm", Page 19
Dry the cooking compartment	→ "Drying", Page 28

## 11.5 Extending the cooking time

1. To extend the cooking time, press "Add extra cooking time".
2. Use the  or  button to change the settings, if required.
3. Press  to confirm the settings.

## 11.6 Keeping a dish warm

1. To keep the dish warm, press "Keep warm".
2. Use the  or  button to change the settings, if required.
3. Press  to confirm the settings.
4. Press  to start the keep warm function.

## 12 Favourites

In the "Favourites", you can save your settings and use these again.

### Notes

- Depending on the appliance type/software status, you must first download this function to your appliance. You can find more information in the Home Connect app.
- You can only sort and rename favourites in the Home Connect app.

### 12.1 Saving favourites

You can save up to 30 different functions as your favourites.

- ▶ If you set a function, press  "Favourites". To rename a favourite, you must use the Home Connect app. When your appliance is connected, follow the instructions in the app.

### 12.2 Selecting favourites

If you have saved favourites, you can use these to set the operation.

1. Press "Favourites".
2. Press the required favourites.

3. If required, you can change the settings.
4. Press  to start the operation.

### Note:

Observe the instructions for the various functions:

- → "Steam", Page 14

### 12.3 Changing favourites

You can change, sort or rename your saved favourites at any time.

1. To sort or rename the favourites, you must use the Home Connect app. When your appliance is connected, follow the instructions in the app.
2. To change the settings on the appliance, press "Favourites".
3. Press the required favourites.
4. Press .
5. Change the settings.
6. Press "Apply" to confirm the change.

### 12.4 Deleting favourites

1. Press "Favourites".
2. Press the required favourites.
3. Press .
4. Press "Delete" to confirm.

## 13 Childproof lock

You can secure your appliance to prevent children from accidentally switching it on or changing the settings.



### 13.1 Activating the childproof lock

The childproof lock disables the control panel to prevent children from accidentally switching on the appliance. To switch on the appliance, deactivate the childproof lock.

### Notes

- When you activate the childproof lock, the appliance will immediately disable the control panel. The  button is the exception and will not be disabled.

- You can also activate the appliance door lock. → "Basic settings", Page 21

1. Press .
2. Press .
- ✓ "Childproof lock activated" appears on the display.

### 13.2 Deactivating the childproof lock

- ▶ Press and hold "Unlock" until "Childproof lock deactivated" appears.



## 14 Rapid heating

With the rapid heating function, you can shorten the heat-up time.

From 200 °C, the rapid heating function is activated automatically.

**Note:** You can deactivate automatic rapid heating from 200 °C in the basic settings.  
→ "Basic settings", Page 21

Rapid heating is possible for the following types of heating:

- "Circo Therm hot air" 
- "Top/bottom heat" 
- "Bread baking setting" 

### 14.1 Activating rapid heat-up

To ensure an even cooking result, do not place the food in the cooking compartment until rapid heating has come to an end.

**Note:** Do not set a cooking time until rapid heating has come to an end.

1. Set a suitable type of heating and a temperature of at least 100 °C.  
Rapid heating automatically switches on at temperatures of 200 °C and above.
2. Press .

3. Press  $\triangleright$ || to start the operation.
- ✓ Once rapid heating has ended, "Rapid heating" switches off automatically and a signal sounds.  $\mathbb{E}$  goes out on the display.
4. Place the food in the cooking compartment.

## 14.2 Deactivating the "Rapid heat-up" function

1. Press  $\wedge$ .
2. Press  $\mathbb{E}$ .

# 15 Basic settings

You can configure the basic settings for your appliance to meet your needs.

## 15.1 Overview of the basic settings

Here you can find an overview of the basic settings and factory settings. The basic settings depend on the features of your appliance.

You can find more information about the individual basic settings on the display using "Information".

Basic settings	Selection
Language	See selection on the appliance
Home Connect	Connect the oven to a mobile end device and remotely control it
Time	Time in 24-hour format
Date	Date in the format DD.MM.YYYY

Display	Selection
Brightness	<ul style="list-style-type: none"> <li>■ 1</li> <li>■ 2</li> <li>■ 3</li> <li>■ 4</li> <li>■ 5<sup>1</sup></li> </ul>
Standby screen	<ul style="list-style-type: none"> <li>■ On for a limited time</li> <li>■ On (this setting increases energy consumption)</li> <li>■ Off<sup>1</sup></li> </ul>
Clock	<ul style="list-style-type: none"> <li>■ Digital + date<sup>1</sup></li> <li>■ Digital</li> <li>■ Analogue + date</li> <li>■ Analogue</li> </ul>
Adjustment	Align the display horizontally and vertically

<sup>1</sup> Factory setting (may vary according to model)

Sound	Selection
Button tone	<ul style="list-style-type: none"> <li>■ On<sup>1</sup></li> <li>■ Off</li> </ul>
Signal tone	<ul style="list-style-type: none"> <li>■ Very short duration</li> <li>■ Short duration</li> <li>■ Medium duration<sup>1</sup></li> <li>■ Long duration</li> </ul>

<sup>1</sup> Factory setting (may vary according to model)

Appliance settings	Selection
Fan run-on time	<ul style="list-style-type: none"> <li>■ Minimum</li> <li>■ Recommended<sup>1</sup></li> <li>■ Long</li> <li>■ Very long</li> </ul>

<sup>1</sup> Factory setting (may vary according to model)

Appliance settings	Selection
Pull-out system	<ul style="list-style-type: none"> <li>■ Retrofitted (if 2 or 3 sets of pull-out rails are fitted)</li> <li>■ Not retrofitted (if shelf supports and a single set of pull-out rails are fitted)<sup>1</sup></li> </ul>
Illumination	<ul style="list-style-type: none"> <li>■ On when cooking and opening the door<sup>1</sup></li> <li>■ Only when the door is opened</li> <li>■ Always off</li> </ul>
Water hardness	<ul style="list-style-type: none"> <li>■ 4 (very hard)<sup>1</sup></li> <li>■ 3 (hard)</li> <li>■ 2 (medium)</li> <li>■ 1 (soft)</li> <li>■ 0 (softened)</li> </ul>

<sup>1</sup> Factory setting (may vary according to model)

Personalisation	Selection
Brand logo	<ul style="list-style-type: none"> <li>■ Display<sup>1</sup></li> <li>■ Do not display</li> </ul>
Operation after switch-on	<ul style="list-style-type: none"> <li>■ Main menu<sup>1</sup></li> <li>■ Types of heating</li> <li>■ Steam</li> <li>■ Dishes</li> <li>■ Favourites</li> </ul>
Elapsed cooking time	<ul style="list-style-type: none"> <li>■ Display<sup>1</sup></li> <li>■ Do not display</li> </ul>
Regional dishes	<ul style="list-style-type: none"> <li>■ All<sup>1</sup></li> <li>■ European dishes</li> <li>■ British dishes</li> </ul>
Dishes	<ul style="list-style-type: none"> <li>■ All<sup>1</sup></li> <li>■ No pork</li> <li>■ Kosher only</li> </ul>
Childproof lock	<ul style="list-style-type: none"> <li>■ Keylock only<sup>1</sup></li> <li>■ Door lock + keylock</li> <li>■ Deactivated</li> </ul>
Automatic rapid heating	<ul style="list-style-type: none"> <li>■ On<sup>1</sup></li> <li>■ Off</li> </ul>

<sup>1</sup> Factory setting (may vary according to model)

Factory settings	Selection
Factory settings	<ul style="list-style-type: none"> <li>■ Cancel</li> <li>■ Restore</li> </ul>

Appliance information	Display
Appliance information	Display technical information about the appliance

## 15.2 Changing basic settings

1. Press  $\odot$  to switch the appliance on.
2. Press "Basic settings".
3. Use  $\langle$  or  $\rangle$  to scroll through the basic settings or categories.
4. Press the required basic setting or category.

- Press the required basic setting in a category.
5. Swipe left or right to select the required setting.
  6. Press  $\checkmark$  to confirm the change.  
If  $\checkmark$  does not appear, the change is applied immediately.
  7. To change other basic settings, use  $\leftarrow$  to return to the basic settings.

# 16 Home Connect

This appliance is network-capable. Connecting your appliance to a mobile device lets you control its functions via the Home Connect app, adjust its basic settings and monitor its operating status.

The Home Connect services are not available in every country. The availability of the Home Connect function depends on the availability of Home Connect services in your country. You can find information about this at: [www.home-connect.com](http://www.home-connect.com).

The Home Connect app guides you through the entire login process. Follow the instructions in the Home Connect app to configure the settings.

**Tip:** Please also follow the instructions in the Home Connect app.

### Notes

- Please note the safety precautions in this instruction manual and make sure that they are also observed when operating the appliance via the Home Connect app.  
→ "Safety", Page 2
- Operating the appliance on the appliance itself always takes priority. During this time it is not possible to operate the appliance using the Home Connect app.
- In networked standby mode, the appliance requires a maximum of 2 W.

## 16.1 Setting up the Home Connect app

1. Install the Home Connect app on your mobile device.
2. Start the Home Connect app and set up access for Home Connect.  
The Home Connect app guides you through the entire login process.

## 16.2 Setting up Home Connect

### Requirements

- The appliance is connected to the power supply and is switched on.
  - You have a mobile device with a current version of the iOS or Android operating system, e.g. a smartphone.
  - The Home Connect app has been installed on your mobile device.
  - The appliance is receiving signals from the WLAN home network (Wi-Fi) at its installation location.
  - The mobile device and the appliance are within range of your home network's Wi-Fi signal.
1. Open the Home Connect app and scan the following QR code.



2. Follow the instructions in the Home Connect app.

## 16.3 Home Connect settings

You can adjust the Home Connect settings and network settings in your appliance's basic settings.

Which settings the display shows will depend on whether Home Connect has been set up and whether the appliance is connected to your home network.

Basic setting	Possible settings	Explanation
Home Connect assistant	Start the assistant Disconnect	You can connect your appliance to the Home Connect app via the Home Connect assistant. <b>Note:</b> If you are using the Home Connect assistant for the first time, only the "Start assistant" setting is available.

Basic setting	Possible settings	Explanation
Wi-Fi	On Off	You can use the Wi-Fi to switch off the network connection for your appliance. When you have connected successfully once, you can deactivate the Wi-Fi and not lose your detailed data. As soon as you activate Wi-Fi again, the appliance connects automatically. <b>Note:</b> In networked standby mode, the appliance requires a maximum of 2 W.
Remote control status	Monitoring Manual remote start Permanent remote start	During monitoring, you can only view the operating status of the appliance in the app. If you convert from monitoring or permanent remote start to manual remote start, you must activate the remote start each time. You can open the appliance door within 15 minutes of having activated remote start. Remote start will not be deactivated by this. Once 15 minutes have elapsed, opening the appliance door will deactivate manual remote start. For permanent remote start, you can start and operate the appliance remotely at any time. If you often operate the appliance remotely, it is helpful to set the remote start to "Permanent".

## 16.4 Operating the appliance with the Home Connect app

You can use the Home Connect app to set and start the appliance remotely.

### **WARNING – Risk of fire!**

Combustible objects that are left in the cooking compartment may catch fire.

- ▶ Never store combustible objects in the cooking compartment.
- ▶ If smoke is emitted, the appliance must be switched off or the plug must be pulled out and the door must be held closed in order to stifle any flames.

### Requirements

- The appliance is switched off.
- The appliance is connected to the home network and to the Home Connect app.
- In order to be able to set the appliance via the app, the manual or permanent remote start must be selected in the "Remote control status" basic setting.

1. To activate manual remote start, press .  
You only have to confirm on the oven if you are switching from monitoring or permanent remote start to manual remote start.  
With permanent remote start, you do not need to confirm on the oven.
2. Configure a setting in the Home Connect app and send it to the appliance.

### Notes

- When you start the oven using the controls on the appliance itself, the remote start function is activated automatically. You can use the Home Connect app to adjust the settings or start a new programme.
- You can open the appliance door within 15 minutes of having activated remote start. Remote start will not be deactivated by this. Once 15 minutes have elapsed, opening the appliance door will deactivate manual remote start.

## 16.5 Software update

Your appliance's software can be updated using the software update function, e.g. for the purposes of optimisation, troubleshooting or security updates. To do this, you must be a registered Home Connect user, have installed the app on your mobile device and be connected to the Home Connect server. As soon as a software update is available, you will be informed via the Home Connect app and will be able to start the software update via the app. Once the update has been successfully downloaded, you can start installing it via the Home Connect app if you are in your home network (Wi-Fi). The Home Connect app informs you once installation is successful.

### Notes

- The software update consists of two steps.
  - The first step is the download.
  - The second step is the installation on your appliance.
- You can continue to use your appliance as normal while updates are downloading. Depending on your personal settings in the app, software updates can also be set to download automatically.
- Installation takes a few minutes. You cannot use your appliance during installation.
- We recommend that you install security updates as soon as possible.

## 16.6 Remote diagnostics

Customer Service can use Remote Diagnostics to access your appliance if you contact them, have your appliance connected to the Home Connect server and if Remote Diagnostics is available in the country in which you are using the appliance.

**Tip:** For further information and details about the availability of Remote Diagnostics in your country, please visit the service/support section of your local website: [www.home-connect.com](http://www.home-connect.com).

## 16.7 Data protection

Please see the information on data protection.

The first time your appliance is registered on a home network connected to the Internet, your appliance will transmit the following types of data to the Home Connect server (initial registration):

- Unique appliance identification (consisting of appliance codes as well as the MAC address of the installed Wi-Fi communication module).
- Security certificate of the Wi-Fi communication module (to ensure a secure data connection).

- The current software and hardware version of your appliance.
- Status of any previous resetting to factory settings.

This initial registration prepares the Home Connect functions for use and is only required when you want to use the Home Connect functions for the first time.

**Note:** Please note that the Home Connect functions can only be utilised with the Home Connect app. Information on data protection can be retrieved in the Home Connect app.

## 17 Cleaning and servicing

To keep your appliance working efficiently for a long time, it is important to clean and maintain it carefully.

### 17.1 Cleaning products

In order to avoid damaging the various oven surfaces on the appliance, do not use unsuitable cleaning products.

#### **⚠ WARNING – Risk of electric shock!**

An ingress of moisture can cause an electric shock.

- ▶ Do not use steam- or high-pressure cleaners to clean the appliance.

#### **ATTENTION!**

Unsuitable cleaning agents damage the surfaces of the appliance.

- ▶ Do not use harsh or abrasive cleaning products.
- ▶ Do not use cleaning products with a high alcohol content.

- ▶ Do not use hard scouring pads or cleaning sponges.
- ▶ Do not use any special cleaners for cleaning the appliance while it is hot.

Using oven cleaner in a hot cooking compartment damages the enamel.

- ▶ Never use oven cleaner in the cooking compartment when it is still warm.
- ▶ Remove all food remnants from the cooking compartment and the appliance door before you next heat up the appliance.

If different cleaning agents are mixed together, there may be a chemical reaction between these.

- ▶ Do not mix cleaning agents.
- ▶ Completely remove any cleaning agent residue. Salt contained in new sponge cloths may damage surfaces.
- ▶ Wash new sponge cloths thoroughly before use.

### Suitable cleaning agents

Only use cleaning agents that are suitable for the different surfaces on your appliance.

Follow the instructions on cleaning the appliance.  
→ "Cleaning the appliance", Page 25

#### Appliance front

Surface	Suitable cleaning agents	Information
Stainless steel	<ul style="list-style-type: none"> <li>▪ Hot soapy water</li> <li>▪ Special stainless steel cleaning products suitable for hot surfaces</li> </ul>	To prevent corrosion, remove any patches of limescale, grease, starch or albumin (e.g. egg white) from stainless steel surfaces immediately. Apply a thin layer of the stainless steel cleaning product.
Plastic or painted surfaces	<ul style="list-style-type: none"> <li>▪ Hot soapy water</li> </ul>	Do not use glass cleaner or a glass scraper. To avoid permanent stains, immediately remove any descaling agent that gets onto the surface.
Glass	<ul style="list-style-type: none"> <li>▪ Hot soapy water</li> </ul>	Do not use glass cleaner or a glass scraper.

#### Appliance door

Area	Suitable cleaning agents	Information
Door panels	<ul style="list-style-type: none"> <li>▪ Hot soapy water</li> <li>▪ Oven cleaner</li> </ul>	Do not use a glass scraper or steel wool. <b>Tip:</b> Remove the door panels in order to clean them thoroughly. → "Appliance door", Page 29
Door cover	<ul style="list-style-type: none"> <li>▪ Made of stainless steel: Stainless steel cleaner</li> <li>▪ Made from plastic: Hot soapy water</li> </ul>	Do not use glass cleaner or a glass scraper. Do not use stainless steel care products. <b>Tip:</b> Remove the door cover for thorough cleaning. → "Appliance door", Page 29



Area	Suitable cleaning agents	Information
Stainless steel interior door frame	<ul style="list-style-type: none"> <li>▪ Stainless steel cleaner</li> </ul>	Discolouration can be removed using stainless steel cleaner. Do not use stainless steel care products.
Door handle	<ul style="list-style-type: none"> <li>▪ Hot soapy water</li> </ul>	To avoid permanent stains, immediately remove any descaling agent that gets onto the surface.
Door seal	<ul style="list-style-type: none"> <li>▪ Hot soapy water</li> </ul>	Do not remove or scrub.

### Cooking compartment

Area	Suitable cleaning agents	Information
Enamel surfaces	<ul style="list-style-type: none"> <li>▪ Hot soapy water</li> <li>▪ Vinegar solution</li> <li>▪ Oven cleaner</li> </ul>	<p>Soak any heavily soiled areas and use a brush or steel wool. Leave the appliance door open to dry the cooking compartment after cleaning it.</p> <p><b>Notes</b></p> <ul style="list-style-type: none"> <li>▪ It is best to use the cleaning function. → "Pyrolytic self-cleaning cleaning function", Page 25</li> <li>▪ Enamel burns at very high temperatures, causing minor discolouration. The functionality of your appliance is not affected by this.</li> <li>▪ The edges of thin trays cannot be completely enamelled and may be rough. This does not impair the corrosion protection.</li> <li>▪ Food residues leave a white coating on the enamel surfaces. The coating does not pose a health risk. The functionality of your appliance is not affected by this. You can remove residues with lemon juice.</li> </ul>
Shelf supports	<ul style="list-style-type: none"> <li>▪ Hot soapy water</li> </ul>	<p>Soak any heavily soiled areas and use a brush or steel wool.</p> <p><b>Note:</b> To clean thoroughly, detach the shelf supports. → "Rails", Page 29</p>
Accessories	<ul style="list-style-type: none"> <li>▪ Hot soapy water</li> <li>▪ Oven cleaner</li> </ul>	Soak any heavily soiled areas and use a brush or steel wool. Enamelled accessories are dishwasher-safe.
Water tank	<ul style="list-style-type: none"> <li>▪ Hot soapy water</li> </ul>	<p>To remove residual detergent after cleaning, rinse thoroughly with clean water.</p> <p>To dry the water tank after cleaning, leave the water tank to dry with the lid open. Dry the seal on the lid.</p> <p>Do not clean in the dishwasher.</p>

## 17.2 Cleaning the appliance

In order to avoid damaging the appliance, you must clean your appliance only as specified, and with suitable cleaning products.

### **WARNING – Risk of burns!**

The appliance and its parts that can be touched become hot during use.

- ▶ Caution should be exercised here in order to avoid touching heating elements.
- ▶ Young children under 8 years of age must be kept away from the appliance.

### **WARNING – Risk of fire!**

Loose food remnants, fat and meat juices may catch fire.

- ▶ Before using the appliance, remove the worst of the food residues and remnants from the cooking compartment, heating elements and accessories.

**Requirement:** Read the information on cleaning products.

→ "Cleaning products", Page 24

1. Clean the appliance using hot soapy water and a dish cloth.
  - For some surfaces, you can use alternative cleaning agents.  
→ "Suitable cleaning agents", Page 24
2. Dry with a soft cloth.

# 18 "Pyrolytic self-cleaning" cleaning function

With the "Pyrolytic self-cleaning"  cleaning function, the cooking compartment is cleaned virtually automatically.

The cleaning function requires approx. 3.9 - 4.8 kilowatt hours.

## 18.1 Preparing the appliance for the cleaning function

To achieve a good cleaning result and prevent damage, prepare the appliance carefully.

**⚠ WARNING – Risk of fire!**

Combustible objects that are left in the cooking compartment may catch fire.

- ▶ Never store combustible objects in the cooking compartment.
- ▶ If smoke is emitted, the appliance must be switched off or the plug must be pulled out and the door must be held closed in order to stifle any flames.

Loose food remnants, fat and meat juices may catch fire when the cleaning function is in progress.

- ▶ Before you start the cleaning function, always remove coarse dirt from the cooking compartment.
- ▶ Never clean accessories at the same time.

The outside of the appliance gets very hot when the cleaning function is in progress.

- ▶ Never hang combustible objects, e.g. tea towels, on the door handle.
- ▶ Leave the front of the appliance clear.
- ▶ Keep children at a safe distance.

If the door seal is damaged, a large amount of heat is generated around the door.

- ▶ Do not scrub or remove the seal.
- ▶ Never operate the appliance if the seal is damaged or missing.

1. Remove the water tank from the appliance.
2. Remove accessories and cookware from the cooking compartment.  
You can also clean the shelf supports.
3. Remove coarse dirt from the cooking compartment and from the shelf supports.
4. Use a detergent solution and a soft cloth to clean the surfaces at the edges of the cooking compartment around the door seal.  
Do not remove or scrub the door seal.  
Use oven cleaner to remove stubborn dirt from the inner door pane.
5. Remove any objects from the cooking compartment.  
The cooking compartment must be empty except for the shelf supports.

## 18.2 Setting the "Pyrolytic self-cleaning" cleaning function

**⚠ WARNING – Risk of harm to health!**

The cleaning function heats up the cooking compartment to a very high temperature so that food left over from roasting, grilling and baking will burn off. This process releases vapours, which can irritate mucous membranes.

- ▶ Keep the kitchen well ventilated while the cleaning function is running.
- ▶ Do not remain in the room for long periods.
- ▶ Keep children and pets away.

**⚠ WARNING – Risk of burns!**

The cooking compartment gets very hot when the cleaning function is in progress.

- ▶ Never open the appliance door.
- ▶ Allow the appliance to cool down.
- ▶ Keep children at a safe distance.

**⚠** The outside of the appliance gets very hot when the cleaning function is in progress.

- ▶ Never touch the appliance door.
- ▶ Allow the appliance to cool down.
- ▶ Keep children at a safe distance.

**Note:** The oven light does not light up while the cleaning function is running.

**Requirement:** → "Preparing the appliance for the cleaning function", Page 25



1. Press "Cleaning".
2. Press "Pyrolytic self-cleaning" .
3. Press "Level" to set the cleaning setting.

Cleaning setting	Cleaning level	Duration in hours
1	Low	Approx. 2:15
2	High	Approx. 2:30

Select the higher cleaning setting if the cooking compartment is particularly dirty or has not been cleaned for a while.

You cannot change the duration of the cleaning function.

Once the cleaning function is in progress, you cannot change the cleaning setting.

- ✓ The duration of the cleaning setting will appear on the display.
- 4. Press  to start the cleaning function.
- ✓ A notification stating that you should carry out the necessary preparatory work for the cleaning function appears on the display.
- 5. Press "OK" to confirm the notification.
- ✓ The cleaning function starts. The duration counts down on the display.
- ✓ For your safety, the appliance door locks the cooking compartment.  appears on the display.
- ✓ Once the cleaning function has run through to the end, an audible signal sounds.
- 6. After using the cleaning function, prepare the appliance for operation.  
→ "Preparing the appliance after the cleaning function", Page 26  
The appliance door will remain locked until the appliance has cooled down sufficiently and  has gone out.

## 18.3 Cancelling the cleaning function

**Note:** You can no longer stop or change the cleaning function once it has started.

- ▶ To cancel the cleaning function, press  to switch the appliance off.

## 18.4 Preparing the appliance after the cleaning function

1. Allow the appliance to cool down.
2. Wipe off any ash that has been left behind in the cooking compartment, on the shelf supports and around the appliance door with a damp cloth.
3. Remove white residues with lemon juice.

**Note:** White residues on the enamel surfaces may be caused by heavy soiling. These food residues are harmless. The deposits do not compromise the functionality of the appliance.

**Note:** While the cleaning function is running, the frame on the inside of the appliance door or other parts of the door that are made of stainless steel become dis-

coloured. This discolouration does not compromise the functionality of the appliance. The discolouration can be removed using a stainless steel cleaner.

## 19 "Easy Clean" cleaning aid

Use the "Easy Clean" cleaning aid for intermediate cleaning of the cooking compartment. The "Easy Clean" cleaning aid softens dirt by vaporising the soapy water. It is then easier to remove the dirt.

### 19.1 Setting the "Easy Clean" cleaning aid

#### **WARNING – Risk of scalding!**

If there is water in the cooking compartment when it is hot, this may create hot steam.

- ▶ Never pour water into the cooking compartment when the cooking compartment is hot.

#### **Notes**

- The oven light does not light up while the cleaning aid is running.
- Do not open the appliance door while the appliance is in operation.

#### **Requirements**

- You can only start the cleaning aid once the cooking compartment is cold (room temperature) and the appliance door is closed.
- To remove particularly stubborn dirt, rub washing-up liquid onto dirty areas on the smooth surfaces before starting the cleaning aid.

1. Remove any accessories from the cooking compartment.

#### 2. **ATTENTION!**

Distilled water in the cooking compartment leads to corrosion.

- ▶ Do not use distilled water.

Mix 0.4 litres water with a drop of washing-up liquid and pour into the centre of the cooking compartment floor.

3. Press "Cleaning".

4. Press "Easy Clean".

5. Press  to start the cleaning aid.

- ✓ A notification stating that you should carry out the necessary preparatory work for the cleaning aid appears on the display.

6. Press "OK" to confirm the notification.

- ✓ The cleaning aid starts. The duration counts down on the display.

- ✓ Once the cleaning aid has run through to the end, an audible signal sounds.

7. Press any button to end the audible signal.

8. After using the cleaning aid, finish cleaning the cooking compartment.

→ "Wiping down the cooking compartment",

Page 27

### 19.2 Wiping down the cooking compartment

#### **ATTENTION!**

The prolonged presence of moisture in the cooking compartment leads to corrosion.

- ▶ After using the cleaning aid, wipe the cooking compartment clean and allow it to dry fully.

**Requirement:** The cooking compartment must have cooled down.

1. Open the appliance door and remove the remaining water with an absorbent sponge cloth.

2. Clean the smooth surfaces in the cooking compartment with a dish cloth or a soft brush. Remove stubborn food remnants using a stainless steel scouring pad.

3. Remove limescale with a cloth soaked in vinegar. Then wipe with clean water and rub dry with a soft cloth (including under the door seal).

4. If there is any stubborn dirt that you are unable to remove, run the cleaning aid again once the cooking compartment has cooled down.

5. In order to dry the cooking compartment, leave the appliance door open for around 1 hour or use the drying function.

→ "Drying", Page 28

## 20 Descaling

To ensure that your appliance continues to operate correctly, it must be descaled regularly.

How frequently you need to run the descaling programme depends on the water hardness and how many times you have used the steam-assisted operations. The appliance indicates when only another 5 or fewer steam-assisted operations are possible. If you do not carry out descaling, you can no longer set any operation with steam.

Descaling comprises several steps and takes approximately 70 - 95 minutes:

- Descaling (approx. 55 - 70 minutes)
- First rinse cycle (approx. 8 - 12 minutes)

- Second rinse cycle (approx. 8 - 12 minutes)

Carry out descaling in full.

If descaling is interrupted, you can no longer set any operation. To ensure that the appliance is ready for operation again, carry out 2 rinse cycles.

## 20.1 Preparing descaling

### ATTENTION!

The length of time for which the descaler is left to work is based on the recommended, liquid descaler. Other descalers may damage the appliance.

- ▶ Only use the liquid descaler recommended by us for the descaling programme.

If descaling solution comes into contact with the control panel or other delicate surfaces, it will damage them.

- ▶ Remove descaling solution immediately with water.

1. Mix the descaling solution:
  - 200 ml liquid descaler
  - 400 ml water
2. Open the control panel.
3. Remove the water tank and fill it with descaling solution.
4. Once the descaling solution has been poured into the water tank, slide the tank back in.
5. Close the control panel.

## 20.2 Setting the descaling process

### ATTENTION!

If descaling solution comes into contact with the control panel or other delicate surfaces, it will damage them.

- ▶ Remove descaling solution immediately with water.

**Requirement:** → "Preparing descaling", Page 28

1. Press "Cleaning".
  2. Press "Descaling" .
- ✓ The duration appears on the display. You cannot change the duration of the descaling process.

3. Press  to start the descaling process.
  - ✓ A notification stating that you should carry out the necessary preparatory work for descaling appears on the display.
4. Press "OK" to confirm the notification.
  - ✓ The descaling process starts. The duration counts down on the display.
  - ✓ Once the descaling programme has run through to the end, an audible signal sounds.

## 20.3 Running the first rinse cycle

1. Open the control panel and remove the water tank.
2. Thoroughly rinse the water tank and fill it with fresh water.
3. Slide in the water tank and close the control panel.
  - ✓ The rinse cycle starts. The duration counts down on the display.
  - ✓ Once the rinse cycle has run through to the end, an audible signal sounds.

## 20.4 Running the second rinse cycle

1. Open the control panel and remove the water tank.
2. Thoroughly rinse the water tank and fill it with fresh water.
3. Slide in the water tank and close the control panel.
  - ✓ The rinse cycle starts. The duration counts down on the display.
  - ✓ Once the rinse cycle has run through to the end, an audible signal sounds.
4. Empty and dry the water tank.
  - "Emptying the water tank", Page 17

# 21 Drying

To prevent residual moisture, dry the cooking compartment following operation with steam.

## 21.1 Drying the cooking compartment

### WARNING – Risk of burns!

The appliance becomes hot during operation.

- ▶ Allow the appliance to cool down before cleaning.

### ATTENTION!

If there is water on the cooking compartment floor when operating the appliance at temperatures above 120 °C, this will damage the enamel.

- ▶ Do not use the appliance if there is water on the cooking compartment floor.
- ▶ Wipe away any water on the cooking compartment floor before operation.

**Requirement:** The cooking compartment has cooled down.

1. Remove any food remnants from the cooking compartment.
2. Dry the cooking compartment with a sponge.
3. Remove limescale marks with a cloth soaked in vinegar, then wipe with clean water and dry with a soft cloth.

4. Leave the cooking compartment to dry with the appliance door open for 1 hour or use "Drying function".
  - "Setting 'Drying function'", Page 28

## 21.2 Setting "Drying function"

**Requirement:** → "Drying the cooking compartment", Page 28

1. Press "Cleaning".
2. Press "Drying function".
  - ✓ The duration appears on the display. You cannot change the duration of the drying function.
3. Start the drying function using .
  - ✓ A notification stating that you should carry out the necessary preparatory work for the drying function appears on the display.
4. Press "OK" to confirm the notification.
  - ✓ The drying function starts. The duration counts down on the display.
  - ✓ Once the drying function has run through to the end, an audible signal sounds.
5. Leave the appliance door open for 1-2 minutes so that the cooking compartment dries completely.

## 22 Rails

To thoroughly clean the rails and the cooking compartment, or to replace the rails, you can remove the rails.

### 22.1 Detaching the rails

**⚠ WARNING – Risk of burns!**

The shelf supports get very hot

- ▶ Never touch the shelf supports when hot.
- ▶ Always allow the appliance to cool down.
- ▶ Keep children at a safe distance.

1. Lift the rail forwards slightly ① and detach it ②.
2. Pull the whole rail to the front ③ and remove it.

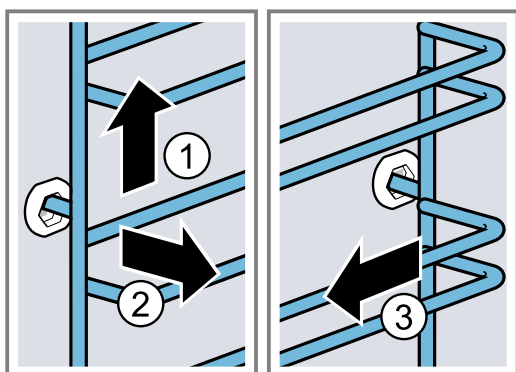

3. Clean the rail.  
→ "Cleaning products", Page 24

### 22.2 Attaching the rails

**Notes**

- The rails only fit on the right or left.
  - For both rails, ensure that the curved rods are at the front.
1. First, push the rail into the middle of the rear socket ① until the rail rests against the cooking compartment wall, and then push this back ②.
  2. Push the rail into the front socket ③ until the rail also rests against the cooking compartment wall, and then press this downwards ④.

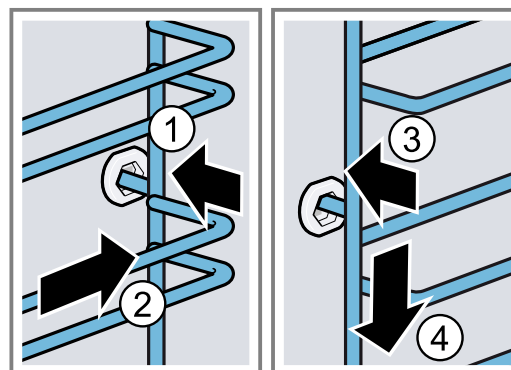

## 23 Appliance door

To clean the appliance door thoroughly, you can disassemble the appliance door.

**⚠ WARNING – Risk of injury!**

If the hinges are not secured due to an incomplete lock, they can snap shut with great force.

- ▶ To detach or attach the appliance door, always turn the two locks as far as they will go.
- ▶ If the hinge snaps closed when detaching or attaching the appliance door, do not reach into the hinge – call the after-sales service.

**Note:**

Further information:



1. To make it easier to see the door lock, shine the torch into the gap beside the appliance door.

### 23.1 Detaching the appliance door

**Requirements**

- Have a torch ready.
- Have a screwdriver ready.
- Have a coin ready.

2. Hold the screwdriver horizontally ① and use it to push the door lock (black component) on each side of the door upwards as far as it will go ②.

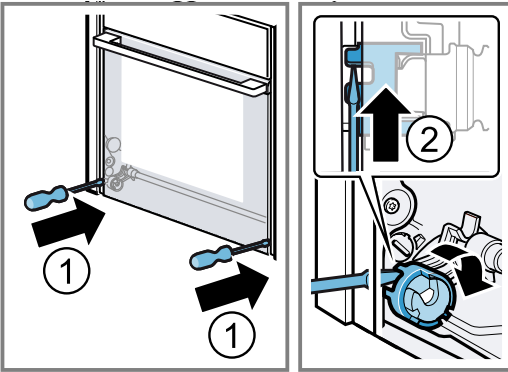

Door lock open

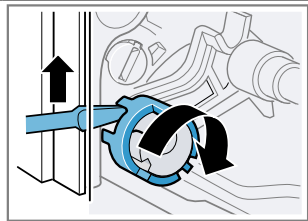

Door lock closed

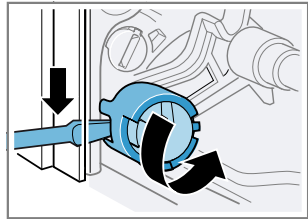

3. Open the appliance door approx. 45° wide.

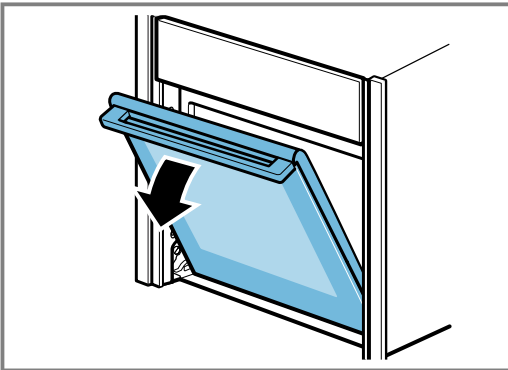

4. Insert the coin in the gap in the lock ① and rotate as far as it will go ②.
- Turn the lock on the left-hand side in a clockwise direction.
  - Turn the lock on the right-hand side in an anti-clockwise direction.

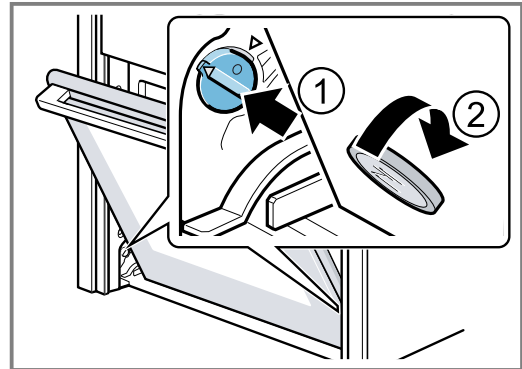

Left-hand lock not secured  
The arrows do not point to each other

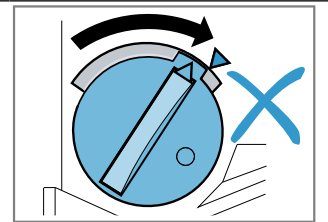

Left-hand lock secured  
The arrows point to each other

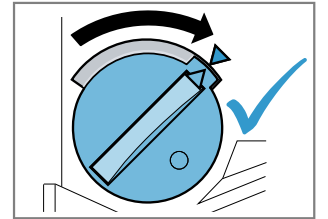

Left-hand lock released

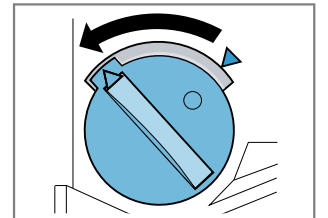

- ✓ The lock audibly engages.

**5. ATTENTION!**

Opening and closing the appliance door when it is in the lock position damages the door hinges.

- ▶ Never force the appliance door open or closed.
- ▶ If the door hinge has been damaged, call the after-sales service.

Carefully move the appliance door back and forth in the direction of both arrows until you hear a quiet click. You can still only move the appliance door slightly.

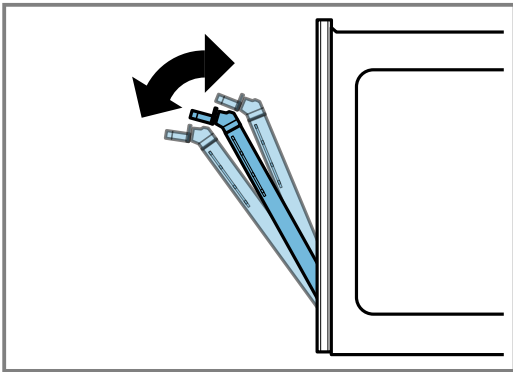
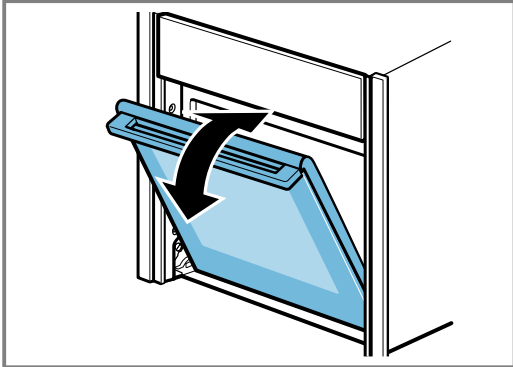

- ✓ The appliance door is in the lock position.

**6. ⚠ WARNING – Risk of injury!**

The appliance door has a weight of 7–10 kg and may fall if it is not handled carefully.

- ▶ Handle the appliance door carefully.

The door handle is not suitable for carrying the appliance door. The door handle may break off.

- ▶ Never carry the appliance door by the door handle.
- ▶ Grab hold of the appliance door with both hands on the left and right to carry it.

Take hold of the appliance door with both hands, one on the left and one on the right, and at the same time slightly rotate the door handle upwards ① until you are able to pull up the appliance door and remove it ②.

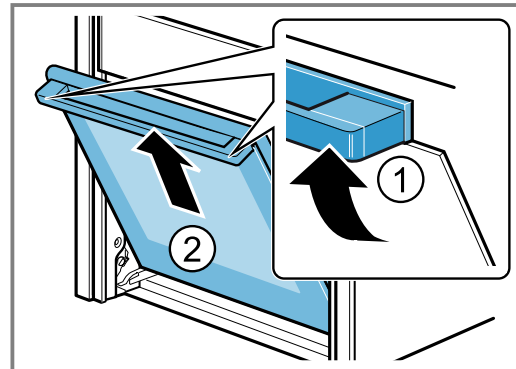

- 7. Set the appliance door down on a flat, soft, clean surface.

**23.2 Attaching the appliance door**

- 1. **Tip:** Ensure that the appliance door is not wedged at an angle and that it is properly fitted in place.

Attach the appliance door via the left- and right-hand guide rollers simultaneously [a].

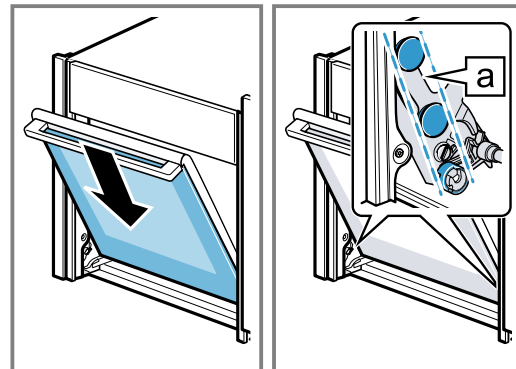

2. Rotate the door handle upwards slightly ①.

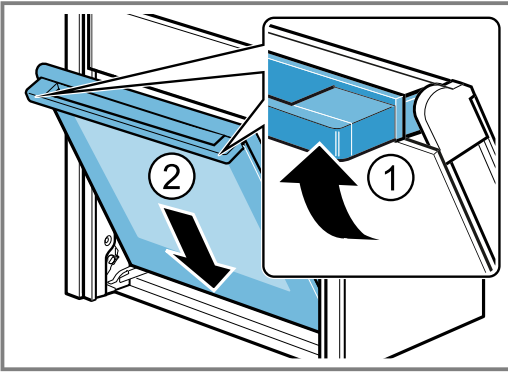

- ✓ The appliance door will slide the short distance remaining to the bottom ②.
3. Use a coin to release both locks on the appliance door. Insert the coin in the gap in the lock ① and rotate as far as it will go ②.
- Turn the lock on the left-hand side in an anti-clockwise direction.
  - Turn the lock on the right-hand side in a clockwise direction.

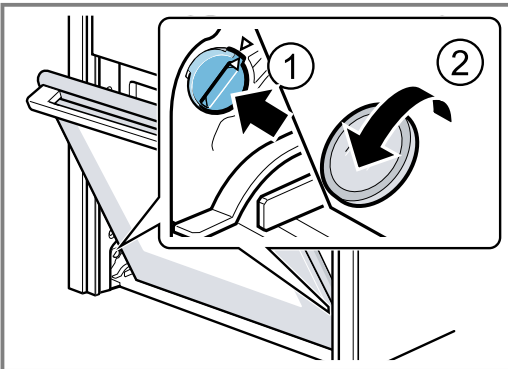

4. Open the appliance door slightly until you hear a quiet click, and then close the appliance door.
5. **⚠ WARNING – Risk of injury!**  
If the door locks are unsecured, the appliance door may become detached.
- ▶ After attaching the appliance door, close the left- and right-hand door locks.
- Hold the screwdriver horizontally ① and use it to push the door lock (black component) on each side of the door downwards as far as it will go ②.

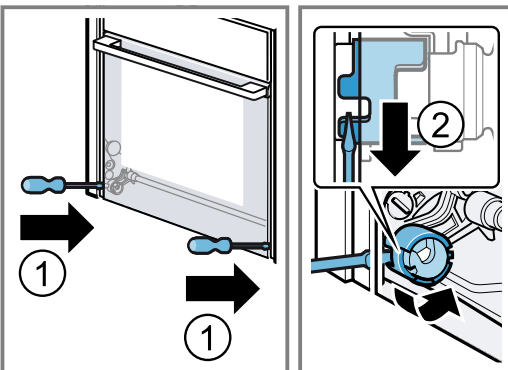

- ✓ The door lock is closed.

### 23.3 Removing the door panes

To facilitate cleaning, you can remove the door pane.

#### **⚠ WARNING – Risk of injury!**

Components inside the appliance door may have sharp edges.

- ▶ Wear protective gloves.

#### **Requirements**

- Have a screwdriver ready.
  - The appliance door is detached.  
→ "Detaching the appliance door", Page 29
1. Lay the appliance door with the front side facing down on a flat surface that is soft and clean.
  2. Undo and remove the left- and right-hand screws on the appliance door.

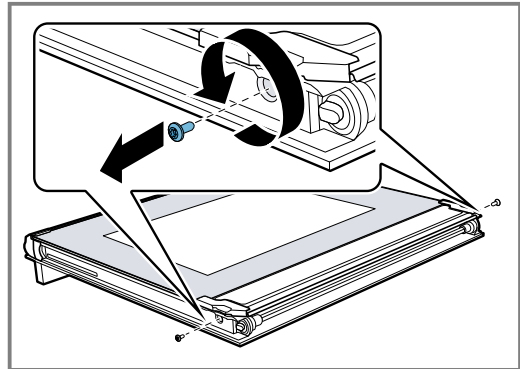

3. Carefully lift the inner pane upwards at an angle ① and remove the holder [a] ②.
4. Carefully lift the inner pane upwards at an angle and remove it in the direction of the arrow ③.

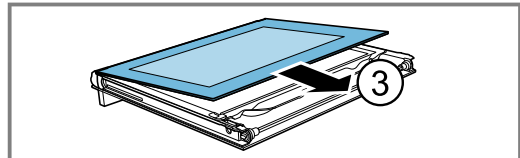
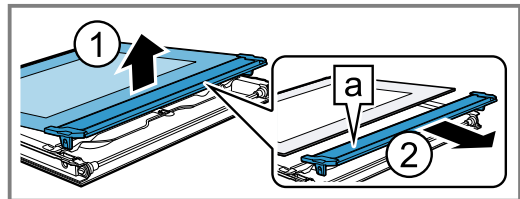

5. Push down on the intermediate pane in the area of [a], and carefully lift the retainer [b] until you are able to pull it out.

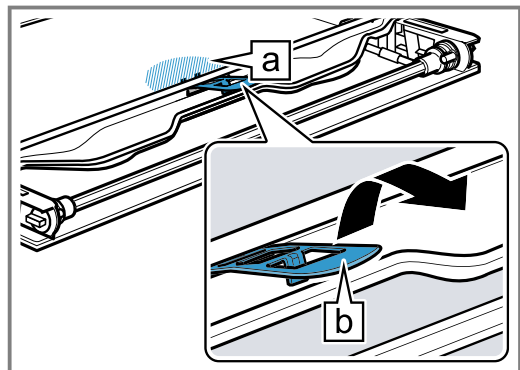



6. Lift the first and second intermediate panes from below ① and remove them in the direction of the arrow ②.

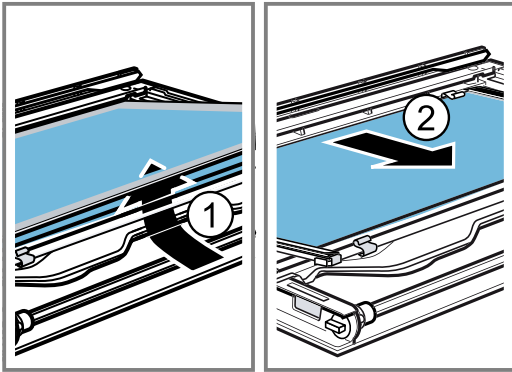

7. Remove the spacers **a** and seals **b** for cleaning, if required.

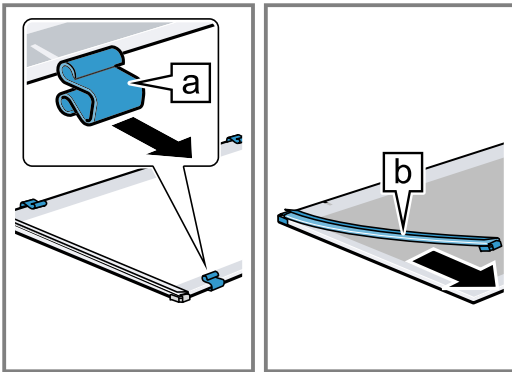

8. **⚠ WARNING – Risk of injury!**  
 Scratched glass in the appliance door may develop into a crack.  
 ▶ Do not use any harsh or abrasive cleaners or sharp metal scrapers to clean the glass on the oven door, as they may scratch the surface.  
 Clean the door panes on both sides with glass cleaner and a soft cloth.
9. Dry the door panes and refit them.  
 → "Fitting the door panes", Page 33

### 23.4 Fitting the door panes

- ⚠ WARNING – Risk of injury!**  
 If a door pane or appliance door has not been installed correctly, this is dangerous.  
 ▶ Make sure that all of the door panes and the appliance door have been correctly fitted before you switch the appliance back on again.

1. **Tip:** When fitting the door panes, make sure that they are in the original order.  
 Insert the intermediate pane so that the **a** arrow on the right-hand side is pointing upwards.

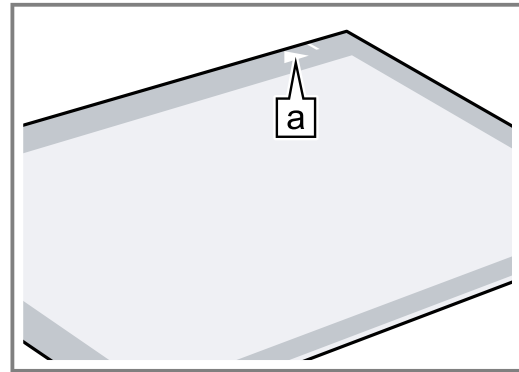

2. Check the fit of the four spacers and two seals.  
 – Place the spacers on the centre of the lines **a** ①.  
 – Secure the seals at the corners ②.

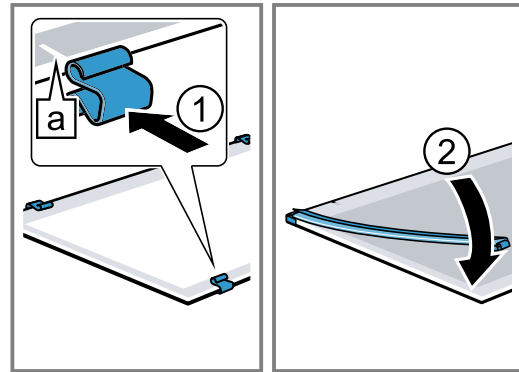

3. Insert the intermediate pane with spacers and seals in the direction of the arrow ①.  
 The arrow on the intermediate pane must line up with the arrow on the frame **a**.
4. Insert the second intermediate pane without the spacers and seals, and slide it in the direction of the arrow until it is inserted in the frame ②.

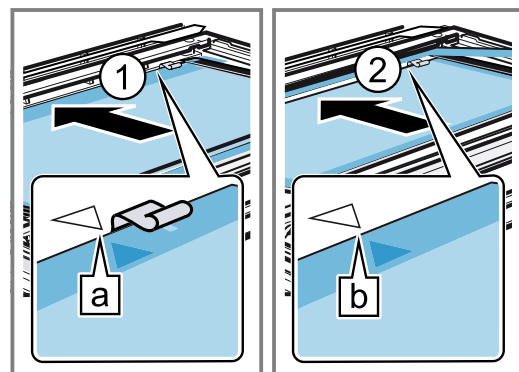

The arrow on the intermediate pane must line up with the arrow on the frame **b**.

5. Push down on the intermediate pane around **a**, slide the retainer **b** in at an angle and push down until it clicks into place.

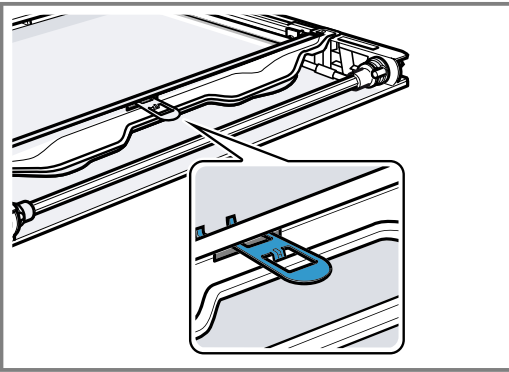

✓ The retainer has been inserted.

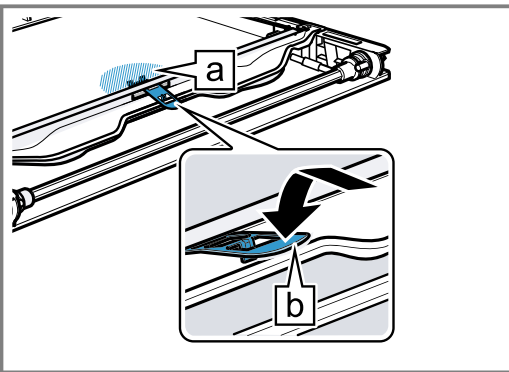

6. Place the inner pane onto the appliance door so that the number **a** is legible at the bottom right. Insert the inner pane into the fixing rail **b** at an angle towards the back.

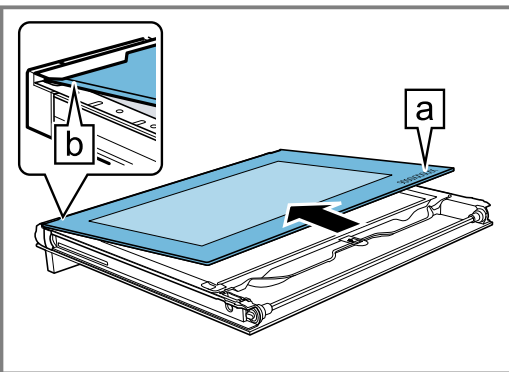

7. Carefully lift the inner pane upwards at an angle and attach the holder **a**.

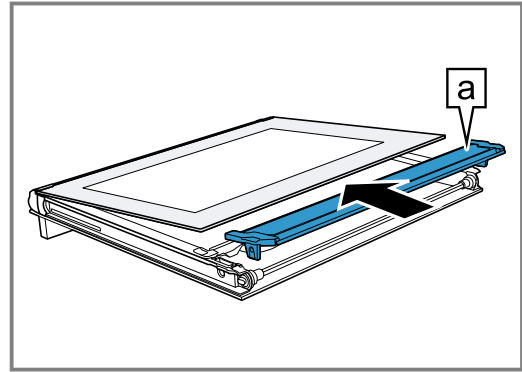

8. Insert the inner pane with the holder **a** into the opening.

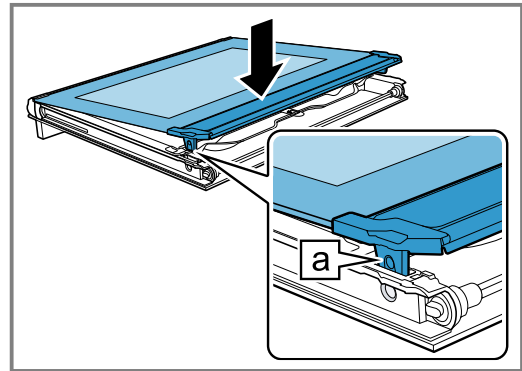

9. Screw both screws back in on the left and right of the appliance door.

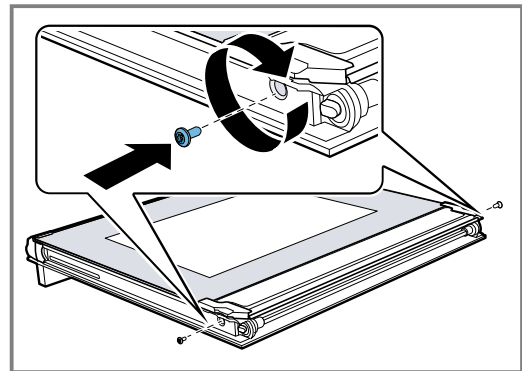

## 24 Troubleshooting

You can rectify minor faults on your appliance yourself. Read the troubleshooting information before contacting after-sales service. This will avoid unnecessary costs.

### **⚠ WARNING – Risk of injury!**

Improper repairs are dangerous.



- ▶ Repairs to the appliance should only be carried out by trained specialist staff.
- ▶ If the appliance is defective, call Customer Service.  
→ "Customer Service", Page 37



### **⚠ WARNING – Risk of electric shock!**

Improper repairs are dangerous.

- ▶ Repairs to the appliance should only be carried out by trained specialist staff.
- ▶ Only use genuine spare parts when repairing the appliance.
- ▶ If the power cord of this appliance is damaged, it must be replaced by trained specialist staff.

## 24.1 Malfunctions

Fault	Cause and troubleshooting
The appliance is not working.	<p>The circuit breaker in the fuse box has tripped.</p> <ul style="list-style-type: none"> <li>▶ Check the circuit breaker in the fuse box.</li> </ul> <hr/> <p>There has been a power cut.</p> <ul style="list-style-type: none"> <li>▶ Check whether the lighting in your room or other appliances are working.</li> </ul> <hr/> <p>Electronics fault</p> <ol style="list-style-type: none"> <li>1. Disconnect the appliance from the power supply for at least 30 seconds by switching off the fuse.</li> <li>2. Reset the basic settings to the factory settings. → <i>"Basic settings", Page 21</i></li> </ol>
"Sprache Deutsch" appears in the display.	<p>There has been a power cut.</p> <ul style="list-style-type: none"> <li>▶ Configure the initial configuration settings. → <i>"Initial use", Page 12</i></li> </ul>
The operation does not start or is interrupted.	<p>Different causes are possible.</p> <ul style="list-style-type: none"> <li>▶ Check the notifications that appear on the display. → <i>"Displaying information", Page 14</i></li> </ul> <hr/> <p>Malfunction</p> <ul style="list-style-type: none"> <li>▶ Call → <i>"Customer Service", Page 37.</i></li> </ul>
Appliance does not heat up.	<p>Demo mode is switched on.</p> <ol style="list-style-type: none"> <li>1. Disconnect the appliance from the power supply for at least 30 seconds by switching off the fuse.</li> <li>2. Switch off demo mode in the basic settings within approx. 5 minutes. → <i>"Changing basic settings", Page 22</i></li> </ol> <hr/> <p>There has been a power cut.</p> <ul style="list-style-type: none"> <li>▶ Open and close the appliance door once after a power failure.</li> <li>✓ The appliance is checked and is ready to use.</li> </ul>
The time is not displayed when the appliance is switched off.	<p>Basic setting has been changed.</p> <ul style="list-style-type: none"> <li>▶ Change the basic setting for the clock. → <i>"Basic settings", Page 21</i></li> </ul>
Appliance door cannot be opened.	<p>The cleaning function locks the appliance door;  lights up in the display.</p> <ul style="list-style-type: none"> <li>▶ Allow the appliance to cool down until  goes out in the display. → <i>"Pyrolytic self-cleaning cleaning function", Page 25</i></li> </ul> <hr/> <p>The childproof lock locks the appliance door.</p> <ul style="list-style-type: none"> <li>▶ Deactivate the childproof lock using "Unlock". → <i>"Childproof lock", Page 20</i> You can switch off the lock in the basic settings. → <i>"Basic settings", Page 21</i></li> </ul>
Home Connect is not working properly.	<p>Different causes are possible.</p> <ul style="list-style-type: none"> <li>▶ Go to <a href="http://www.home-connect.com">www.home-connect.com</a>.</li> </ul>
The control panel cannot be opened.	<p>The circuit breaker in the fuse box has tripped.</p> <ul style="list-style-type: none"> <li>▶ Check the circuit breaker in the fuse box.</li> </ul> <hr/> <p>There has been a power cut.</p> <ul style="list-style-type: none"> <li>▶ Check whether the lighting in your room or other appliances are working.</li> </ul> <hr/> <p>Malfunction</p> <ol style="list-style-type: none"> <li>1. Call the after-sales service. → <i>"Customer Service", Page 37</i></li> <li>2. If there is water in the water tank, empty the water tank:             <ul style="list-style-type: none"> <li>- Open the appliance door.</li> <li>- Grip on the right and left below the control panel.</li> <li>- Slowly pull out the control panel and push it upwards.</li> </ul> </li> </ol>

Fault	Cause and troubleshooting
The appliance requests descaling without the counter appearing in advance.	<p>The set water hardness range is too low.</p> <ol style="list-style-type: none"> <li>1. Descal the appliance. → <i>"Descaling", Page 27</i></li> <li>2. Check the water hardness and set this in the basic settings. → <i>"Basic settings", Page 21</i></li> </ol>
The appliance prompts you to rinse it.	<p>During the descaling, the power supply is interrupted or the appliance is switched off.</p> <ul style="list-style-type: none"> <li>▶ Rinse the appliance. → <i>"Descaling", Page 27</i></li> </ul>
"Fill water tank" appears in the display even though the water tank has been filled.	<p>The water tank has not clicked into place.</p> <ul style="list-style-type: none"> <li>▶ Insert the water tank correctly so that it engages in the holder. → <i>"Filling the water tank", Page 15</i></li> </ul> <p>The water tank has fallen out. Shaking has caused parts to come loose in the water tank. The water tank is leaking.</p> <ul style="list-style-type: none"> <li>▶ Order a new water tank. → <i>"Customer Service", Page 37</i></li> </ul>
	<p>Malfunction</p> <ul style="list-style-type: none"> <li>▶ Do not use deionised or filtered water. → <i>"Determining the water hardness before switching on the appliance for the first time", Page 12</i></li> </ul> <p>The sensor is defective.</p> <ul style="list-style-type: none"> <li>▶ Call → <i>"Customer Service", Page 37.</i></li> </ul>
Buttons are flashing.	<p>Condensation has formed behind the control panel. No action required. As soon as the condensation has evaporated, the buttons no longer flash.</p>
"Plopping" sounds can be heard when cooking with steam.	<p>Water vapour requires the cold/heat effect for frozen food. No action required.</p>
The appliance hums during operation and after it is switched off.	<p>Functional test of the pump creates operating noise. No action required.</p>
The interior lighting does not work.	<p>Basic setting has been changed.</p> <ul style="list-style-type: none"> <li>▶ Change the basic setting for the lighting. → <i>"Basic settings", Page 21</i></li> </ul> <p>The LED light is defective.</p> <ul style="list-style-type: none"> <li>▶ Call → <i>"Customer Service", Page 37.</i></li> </ul>
A notification appears on the display confirming that the maximum operating time has been reached.	<p>The maximum operating time has been reached. The appliance stops heating.</p> <ol style="list-style-type: none"> <li>1. Press "OK" to confirm the notification about the maximum operating time.</li> <li>2. Check whether you still need the appliance.</li> </ol> <ul style="list-style-type: none"> <li>▶ Set a cooking time so that the operation does not stop. → <i>"Time-setting options", Page 17</i></li> </ul>
The operation stops.	<p>The maximum operating time has been reached. The appliance stops heating.</p> <ol style="list-style-type: none"> <li>1. Press  to switch off the appliance.</li> <li>2. If necessary, press  to switch the appliance back on and then restart the operation.</li> </ol> <ul style="list-style-type: none"> <li>▶ Set a cooking time so that the operation does not stop. → <i>"Time-setting options", Page 17</i></li> </ul>
Error code made up of letters and numbers appears on the display, e.g. E0111.	<p>The electronics have detected a fault.</p> <ol style="list-style-type: none"> <li>1. Switch the appliance off and on again. <ul style="list-style-type: none"> <li>✓ If the fault was a one-off, the message disappears.</li> </ul> </li> <li>2. If the message appears again, call the after-sales service. Please specify the exact error message when calling. → <i>"Customer Service", Page 37</i></li> </ol>

Fault	Cause and troubleshooting
The cooking result is not satisfactory.	Settings were unsuitable. Adjustment values, e.g. temperature or cooking time, depend on the recipe, quantity and food. ▶ Next time, set lower or higher values. <b>Tip:</b> A lot of other information about the food preparation and corresponding adjustment values can be found in the Home Connect app or on our website <a href="http://www.neff-home.com">www.neff-home.com</a> .

## 25 Disposal

### 25.1 Disposing of old appliance

Valuable raw materials can be reused by recycling.

1. Unplug the appliance from the mains.
2. Cut through the power cord.
3. Dispose of the appliance in an environmentally friendly manner.  
Information about current disposal methods are available from your specialist dealer or local authority.



This appliance is labelled in accordance with European Directive 2012/19/EU concerning used electrical and electronic appliances (waste electrical and electronic equipment - WEEE).

The guideline determines the framework for the return and recycling of used appliances as applicable throughout the EU.

## 26 Customer Service

Function-relevant genuine spare parts according to the corresponding Ecodesign Order can be obtained from Customer Service for a period of at least 10 years from the date on which your appliance was placed on the market within the European Economic Area.

**Note:** Under the terms of the manufacturer's warranty the use of Customer Service is free of charge.

Detailed information on the warranty period and terms of warranty in your country is available from our after-sales service, your retailer or on our website.

If you contact Customer Service, you will require the product number (E-Nr.), the production number (FD) and the consecutive numbering (Z-Nr.) of your appliance.

The contact details for Customer Service can be found in the enclosed Customer Service directory or on our website.

This product contains light sources from energy efficiency class G. These light sources are available as a spare part and should only be replaced by trained specialist staff.

### 26.1 Product number (E-Nr.), production number (FD) and consecutive numbering (Z-Nr.)

You can find the product number (E-Nr.), the production number (FD) and the consecutive numbering (Z-Nr.) on the appliance's rating plate.

You will see the rating plate with these numbers if you open the appliance door. On some appliances with steam-assisted cooking, you will find the rating plate behind the control panel.

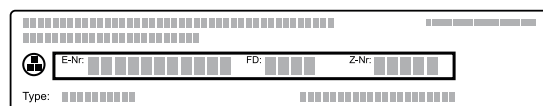

Make a note of your appliance's details and the Customer Service telephone number to find them again quickly.

You can also display the appliance information in the basic settings.

→ "Basic settings", Page 21

## 27 Information regarding Free and Open Source Software

This product includes software components that are licensed by the copyright holders as free or open source software.

The applicable licence information is stored on your home appliance. You can also access the applicable licence information via your Home Connect app: "Profile -> Legal information -> Licence Information".<sup>1</sup> You can download the licence information on the brand product website. (Please search on the product website for your appliance model and additional documents). Al-

ternatively, you can request the relevant information from [ossrequest@bshg.com](mailto:ossrequest@bshg.com) or BSH Hausgeräte GmbH, Carl-Wery-Str. 34, 81739 Munich, Germany.

The source code will be made available to you on request.

Please send your request to [ossrequest@bshg.com](mailto:ossrequest@bshg.com) or BSH Hausgeräte GmbH, Carl-Wery-Str.34, 81739 Munich, Germany.

Subject: „OSSREQUEST“

<sup>1</sup> Depending on the appliance specifications

The cost of performing your request will be charged to you. This offer is valid for three years from the date of purchase or at least as long as we offer support and spare parts for the relevant appliance.

## 28 Declaration of Conformity

BSH Hausgeräte GmbH hereby declares that the appliance with Home Connect functionality conforms to the essential requirements and other relevant provisions of Directive 2014/53/EU.

A detailed RED Declaration of Conformity can be found online at [www.neff-home.com](http://www.neff-home.com) among the additional documents on the product page for your appliance.



Hereby, BSH Hausgeräte GmbH declares that the appliance with Home Connect functionality is in compliance with relevant statutory requirements.<sup>1</sup>

A detailed Declaration of Conformity can be found online at [www.neff-home.com/uk](http://www.neff-home.com/uk) among the additional documents on the product page for your appliance.<sup>1</sup>



2.4 GHz band (2400–2483.5 MHz): Max. 100 mW  
5 GHz band (5150–5350 MHz + 5470–5725 MHz): max. 200 mW

	BE	BG	CZ	DK	DE	EE	IE	EL	ES
	FR	HR	IT	CY	LI	LV	LT	LU	HU
	MT	NL	AT	PL	PT	RO	SI	SK	FI
	SE	NO	CH	TR	IS	UK (NI)			

5 GHz WLAN (Wi-Fi): For indoor use only.

AL	BA	MD	ME	MK	RS	UK	UA
----	----	----	----	----	----	----	----

5 GHz WLAN (Wi-Fi): For indoor use only.

### 28.1 Statement of Compliance for Great Britain

The full Statement of Compliance according to the Product Security and Telecommunications Infrastructure (Security Requirements for Relevant Connectable Products) Regulations 2023 can be found online at [www.neff-home.com/uk/](http://www.neff-home.com/uk/) among the additional documents on the product page for your appliance.

#### Product type

This statement of compliance covers the products described in this information for use whose model identifier group is seen on the title page. The full model identifier is made up of the characters before the slash in the product number (E no.) which can be found on the rating plate. Alternatively, you can also find the model identifier in the first line of the UK Energy Label.

#### Name and address of manufacturer

BSH Hausgeräte GmbH, Carl-Wery-Strasse 34, 81739 München, Germany

This statement of compliance is prepared by the manufacturer.

The manufacturer, BSH Hausgeräte GmbH deems that it has complied with

- provision 5.1-1 of ETSI EN 303 645 v2.1.1 and, where relevant, provision 5.1-2 of ETSI EN 303 645 v2.1.1;
- provision 5.2-1 of ETSI EN 303 645 v2.1.1;
- provision 5.3-13 of ETSI EN 303 645 v2.1.1.

#### Support period

BSH Hausgeräte GmbH will provide security updates that are necessary to maintain the main functions free of charge until at least 28/02/2034.

## 29 How it works

Here, you can find the ideal settings for various types of food as well as the best accessories and cookware. We have perfectly tailored these recommendations to your appliance.

**Tip:** A lot of other information about the preparation, corresponding adjustment values and recipes can be found in the Home Connect app or on our website [www.neff-home.com](http://www.neff-home.com).

### 29.1 General cooking tips

Take note of the following information when cooking all types of food.

- The temperature and cooking time depend on the amount of food and the recipe. Settings ranges are specified for this reason. Try using the lower values to start with.

<sup>1</sup> Only applies to Great Britain

- The setting values apply to food placed in the cooking compartment while the cooking compartment is still cold. If you want to preheat anyway, do not place accessories into the cooking compartment until it has finished preheating.
- Remove any accessories that are not being used from the cooking compartment.

**ATTENTION!**

Acidic food may damage the grid

- ▶ Do not place acidic food, such as fruit or food with an acidic marinade directly on the pan support.

**Information for those allergic to nickel**

In rare cases, small amounts of nickel may pass into the food.

You can buy suitable accessories from customer service, from specialist retailers or online.

→ "Other accessories", Page 12

**29.2 Baking tips**

- Dark-coloured metal baking tins are most suitable for baking cakes, bread and other baked goods.
- Use wide, shallow cookware for bakes and gratins. Food takes longer to cook in deep, narrow cookware and it browns more on top.
- Silicone moulds are not suitable.
- If you are cooking bakes directly in the universal pan, place the universal pan into the cooking compartment at level 2.
- The setting values for bread dough apply to both dough placed on a baking tray and dough placed in a loaf tin.

**ATTENTION!**

When the cooking compartment is hot, any water inside it will create steam. The change in temperature may cause damage.

- ▶ Never pour water into the cooking compartment when it is still hot.
- ▶ Never place cookware containing water on the cooking compartment floor.

**Shelf positions**

If you are using the CircoTherm hot air type of heating, you can choose between shelf positions 1, 2, 3 and 4. You will obtain the best results if you use the following shelf positions.

Baking on one level	Height
Tall baked items and tins/dishes on the wire rack	2
Shallow baked items/baking tray	3

Baking on two or more levels	Height
2 levels	
■ Universal pan	3
■ Baking tray	1
2 levels	
■ Baking tins/dishes on 2 wire racks	3 1

Baking on two or more levels	Height
3 levels	
■ Baking tray	4
■ Universal pan	3
■ Baking tray	1
4 levels	
■ 4 wire racks with greaseproof paper	4 3 2 1

Use the CircoTherm hot air heating function.

**Note:** Items that are placed in the appliance on baking trays or in baking tins/dishes at the same time will not necessarily be ready at the same time.

**29.3 Roasting, braising and grilling tips**

- The recommended settings are for fridge-temperature food and unstuffed, oven-ready poultry.
- Place the poultry onto the cookware breast-side or skin-side down.
- Turn roasting joints, grilled items or whole fish after approx.  $\frac{1}{2}$  to  $\frac{2}{3}$  of the specified time.

**Roasting on the wire rack**

Food roasted on the wire rack will become very crispy on all sides. You can roast large poultry, for example, or multiple individual pieces at the same time.

- Roast pieces of a similar weight and thickness. The grilled food will brown evenly and will remain succulent and juicy.
- Place the food to be roasted directly on the wire rack.
- To catch any liquids that drip down, place the universal pan, with the wire rack inside it, into the cooking compartment at the specified shelf height.
- Add up to  $\frac{1}{2}$  litre of water to the universal pan, depending on the size and type of food that you want to roast.

You can make a sauce from the juices that are collected. This also means that less smoke is produced and the cooking compartment does not become as dirty.

**Roasting in cookware**

If you cover the cookware when you cook your food, this will keep the cooking compartment cleaner.

**General information about roasting in cookware**

- Use heat-resistant, ovenproof cookware.
- Place the cookware on the wire rack.
- Glass cookware is best.
- Follow the manufacturer's instructions for your roasting dishes.

**Roasting in uncovered cookware**

- Use a deep roasting dish.
- If you do not have any suitable cookware, you can use the universal pan.

**Roasting in covered cookware**

- Use a suitable lid that seals well.

- When roasting meat, there should be at least 3 cm between the food and the lid. The meat may expand.

**⚠ WARNING – Risk of scalding!**

Very hot steam may escape when the lid is opened after cooking. Steam may not be visible, depending on the temperature.

- Lift the lid in such a way that the hot steam can escape away from you.
- Keep children away from the appliance.

**Grilling**

Grill food if you want it to be crispy.

The "Grill" type of heating is good for cooking thinner pieces of poultry, meat and fish such as steaks, drumsticks and burgers. It is also excellent for toasting bread.

Circo-roasting is very well suited to cooking whole poultry and fish, as well as meat, e.g. roast pork with crackling.

- When grilling several food items, choose pieces that are of a similar weight and thickness. The grilled food will brown evenly and will remain succulent and juicy.
- Place the food to be grilled directly onto the wire rack.

- To catch any liquids that drip down, place the universal pan into the cooking compartment at least one level below the wire rack.

**Notes**

- The grill element switches on and off continuously. This is normal. The temperature that you set determines how frequently this occurs.
- Smoke may be produced when grilling.

**29.4 Cooking instructions for ready meals**

- The cooking result greatly depends on the quality of the food. Pre-browning and irregularities may already be present in the food before cooking.
- Do not use frozen products that are covered with a thick layer of ice. Remove any ice on the food.
- Take ready meals out of the packaging.
- If you are warming or cooking the ready meal in cookware, make sure that the cookware is heat-resistant.
- Distribute foods that are in the form of separate pieces, such as bread rolls and potato products, so that they are spread out flat and evenly on the accessory. Leave a little space between the individual pieces.
- Follow the manufacturer's instructions on the packaging.

**29.5 List of foods**

Recommended settings for a variety of foods, sorted into food categories.





























**Recommended settings for various types of food**

Food	Accessory/cook-ware	Height	Type of heating	Temperature in °C	Steam level	Cooking time in mins
Sponge cake, delicate	Ring-shaped tin or Loaf tin	2	☰	150-170	-	60-80
Sponge cake, 2 levels	Ring-shaped tin or Loaf tin	3+1	☂	140-160	-	60-80
Fruit tart or cheesecake with shortcrust pastry base	Springform cake tin, diameter 26 cm	2	☰	170-190	-	55-80
Sponge flan, 6 eggs	Springform cake tin Ø 28 cm	2	☂	150-160	-	50-60
Sponge flan, 6 eggs	Springform cake tin Ø 28 cm	2	☂	<b>1.</b> 150-160 <b>2.</b> 150-160	Low -	<b>1.</b> 10 <b>2.</b> 25-35
Shortcrust tart with moist topping	Universal pan	3	☰	160-180	-	55-75
Yeast cake with moist topping	Universal pan	3	☰	180-190	-	30-40
Swiss roll	Baking tray	3	☂	180-200 <sup>1</sup>	Low	10-15
Muffins	Muffin tray	3	☰	170-190	-	15-20
Small yeast cakes	Baking tray	3	☂	160-180	Medium	25-35
Biscuits	Baking tray	3	☂	140-160	-	15-30

<sup>1</sup> Preheat the appliance.









<sup>2</sup> Turn the dish 2/3 of the way through the cooking time.



Food	Accessory/cook-ware	Height	Type of heating	Temperature in °C	Steam level	Cooking time in mins
Biscuits, 2 levels	Universal pan + Baking tray	3+1		140-160	-	15-30
Biscuits, 3 levels	x 2 Baking tray + Universal pan	4+3+1		140-160	-	15-30
Bread, 750 g	Universal pan or Loaf tin	2		<b>1.</b> 210-220 <b>2.</b> 180-190	High -	<b>1.</b> 10-15 <b>2.</b> 25-35
Bread, 1500 g	Universal pan or Loaf tin	2		<b>1.</b> 210-220 <b>2.</b> 180-190	High -	<b>1.</b> 10-15 <b>2.</b> 45-55
Bread, 1500 g	Universal pan or Loaf tin	2		200-210	-	35-45
Flatbread	Universal pan	3		220-230	High	20-30
Bread rolls, fresh	Baking tray	3		200-220	Medium	20-30
Pizza, fresh, on a baking tray	Baking tray	3		200-220	-	25-35
Pizza, fresh, on a baking tray, 2 levels	Universal pan + Baking tray	3+1		180-190	-	35-45
Pizza, fresh, thin-crust, on a pizza tray	Pizza tray	2		220-230	-	20-30
Börek	Universal pan	1		200-220 <sup>1</sup>	-	20-30
Quiche	Dark coated quiche tin	3		190-210	-	30-40
Tarte flambée	Universal pan	3		260-270 <sup>1</sup>	-	10-15
Bake, savoury, cooked ingredients	Ovenproof dish	2		150-170	Medium	40-50
Potato gratin, raw ingredients, 4 cm deep	Ovenproof dish	2		160-190	-	50-70
Chicken, 1.3 kg, unstuffed	Pan support	2		200-220	-	60-70
Chicken, 1.3 kg, unstuffed	Pan support	2		190-210	Medium	50-60
Small chicken portions, 250 g each	Pan support	3		200-220	Medium	30-45
Goose, unstuffed, 3 kg	Pan support	2		160-180	-	120-150
Goose, unstuffed, 3 kg	Pan support	2	<b>1.</b>  <b>2.</b>  <b>3.</b> 	<b>1.</b> 130-140 <b>2.</b> 150-160 <b>3.</b> 170-180	Medium Medium -	<b>1.</b> 110-120 <b>2.</b> 20-30 <b>3.</b> 30-40
Joint of pork without rind, e.g. neck, 1.5 kg	Uncovered cook-ware	2		180-190	-	110-130
Joint of pork without rind, e.g. neck, 1.5 kg	Uncovered cook-ware	2		190-200	-	120-140
Joint of pork with rind, e.g. shoulder, 2 kg	Uncovered cook-ware	2	<b>1.</b>  <b>2.</b>  <b>3.</b> 	<b>1.</b> 100 <b>2.</b> 170-180 <b>3.</b> 200-210	High Low -	<b>1.</b> 25-30 <b>2.</b> 70-90 <b>3.</b> 20-30
Fillet of beef, medium, 1 kg	Pan support	2		210-220	-	40-50
Fillet of beef, medium, 1 kg	Uncovered cook-ware	2		190-200	Low	50-60

<sup>1</sup> Preheat the appliance.

<sup>2</sup> Turn the dish 2/3 of the way through the cooking time.

Food	Accessory/cook-ware	Height	Type of heating	Temperature in °C	Steam level	Cooking time in mins
Pot-roasted beef, 1.5 kg	Covered cookware	2		200-220	-	130-160
Pot-roasted beef, 1.5 kg	Covered cookware	2		200-220	-	140-160
Sirloin, medium, 1.5 kg	Pan support	2		220-230	-	60-70
Sirloin, medium, 1.5 kg	Uncovered cook-ware	2		190-200	Low	65-80
Burger, 3–4 cm thick	Pan support	4		290	-	25-30 <sup>2</sup>
Leg of lamb, boned, me- dium, 1.5 kg	Uncovered cook- ware	2		170-190	-	50-80
Leg of lamb, boned, me- dium, 1.5 kg	Uncovered cook- ware	2		170-180	Low	80-90
Fish, baked, whole, 300 g, e.g. trout	Universal pan	2		<b>1.</b> 170-180 <b>2.</b> 160-170	Low -	<b>1.</b> 15-20 <b>2.</b> 5-10

<sup>1</sup> Preheat the appliance.

<sup>2</sup> Turn the dish 2/3 of the way through the cooking time.

## Desserts

### Making yoghurt

1. Remove the accessories and shelves from the cooking compartment.
2. Heat 1 litre of whole milk (3.5% fat) to 90 °C on the hob and then leave it to cool down to 40 °C. It is sufficient to heat UHT milk to 40 °C.
3. Mix 150 g of chilled yoghurt into the milk.

4. Pour the mixture into small containers, e.g. cups or small jars.
5. Cover the containers with film, e.g. cling film.
6. Place the containers on the cooking compartment floor.
7. Use the recommended settings when configuring the appliance settings.
8. After making the yoghurt, leave it to cool in the refrigerator for at least 12 hours.

### Recommended settings for desserts and compote

Food	Accessory/cook-ware	Height	Heating function	Temperature in °C	Steam in-tensity	Cooking time in mins
Yoghurt	Individual moulds	Cooking compartment floor		35-40	-	300-360

## 29.6 Special cooking methods and other applications

Information and recommended settings for special cooking methods and other applications, e.g. low-temperature cooking.

### Low-temperature cooking

For all prime cuts which are to be cooked rare or "à point". When slow cooking at low temperatures, meat and poultry remain juicy and tender.

### Low-temperature cooking poultry or meat

**Note:** When using the low-temperature cooking type of heating, you cannot delay the start of the programme by setting an end time.

**Requirement:** The cooking compartment is cold.

1. Use fresh, hygienically perfect meat. Pieces without bones and without a lot of connective tissue are most suitable.
2. Place the cookware onto the wire rack at level 2 in the cooking compartment.
3. Preheat the cooking compartment and cookware for approx. 15 minutes.
4. Sear the meat on all sides on the hob at a very high heat.

5. Immediately place the meat into the pre-warmed cookware in the cooking compartment. To ensure that the temperature in the cooking compartment remains constant, keep the cooking compartment door closed during low-temperature cooking.

### Tips for low-temperature cooking

Here you will find tips for achieving good results when low-temperature cooking food.

Issue	Tip
You want to cook a duck breast at a low temperature.	<ul style="list-style-type: none"> <li>Place the cold duck breast into a pan.</li> <li>Sear the skin side first.</li> <li>Cook the duck breast at low temperature.</li> <li>After low-temperature cooking, grill the duck breast for 3 to 5 minutes until crispy.</li> </ul>
You want to serve your low-temperature cooked meat as hot as possible.	<ul style="list-style-type: none"> <li>Preheat the serving plate.</li> <li>Make sure that the accompanying sauces are very hot when you serve them.</li> </ul>

### Recommended settings for low-temperature cooking

Food	Accessory/ cookware	Height	Searing time in mins	Type of heating	Temperat- ure in °C	Steam level	Cooking time in mins
Duck breast, medium rare, 300 g each	Uncovered cookware	2	6-8		90 <sup>1</sup>	-	45-60
Fillet of pork, whole	Uncovered cookware	2	4-6		80 <sup>1</sup>	-	45-70
Fillet of beef, 1 kg	Uncovered cookware	2	4-6		80 <sup>1</sup>	-	90-120
Veal medallions, 4 cm thick	Uncovered cookware	2	4		80 <sup>1</sup>	-	30-50
Saddle of lamb, boned, 200 g each	Uncovered cookware	2	4		80 <sup>1</sup>	-	30-45

<sup>1</sup> Preheat the appliance.

### Proving dough

Yeast dough proves more quickly in your appliance than at room temperature and does not dry out.

**Requirement:** The cooking compartment is cold.

- Slide the wire rack into the cooking compartment.
- Place the dough onto the wire rack in a bowl.  
Do not cover the bowl.

- Use the recommended settings when configuring the appliance settings.  
The values are guide values only. The temperature and proving time are dependent on the type and quantity of the ingredients.
- Do not open the appliance door while the dough is proving, otherwise moisture will escape.
- Wipe the cooking compartment dry before baking in it.

### Recommended settings for proving dough

Food	Accessory/cook- ware	Height	Type of heating	Temperature in °C	Steam level	Cooking time in mins
Rich dough, e.g. panettone	Bowl on wire rack	2		40-45	-	40-90
White bread	Bowl on wire rack	2		35-40	-	30-40

### Reheating

Gently warm up food with added steam. The food tastes and looks as though it has been freshly cooked. You can even warm and crisp up baked goods from the day before.

#### Tips for reheating food

- Use uncovered, heat-resistant cookware that is suitable for cooking with steam.
- Use wide, shallow cookware. Cold cookware extends the reheating time.

- Place the cookware on the wire rack.
- Place food that you are not reheating in cookware (e.g. bread rolls) directly onto the wire rack at level 2.
- Do not cover the food.
- Do not open the cooking compartment door while the food is being reheated, otherwise large amounts of steam will escape.
- Wipe the cooking compartment and dry the drip trough after using it to reheat food.

### Recommended settings for heating and reheating

Food	Accessory/cook- ware	Height	Type of heating	Temperature in °C	Steam level	Cooking time in mins
Plated meal, chilled, 1 portion	Uncovered cook- ware	2		120-130	-	15-25
Pizza, cooked, chilled	Pan support	2		170-180 <sup>1</sup>	-	5-15
Bread rolls, baguette, baked	Pan support	2		150-160 <sup>1</sup>	-	10-20
Pizza, cooked, frozen	Pan support	2		170-180 <sup>1</sup>	-	5-15
Bread rolls, baguette, baked, frozen	Pan support	2		160-170 <sup>1</sup>	-	10-20

<sup>1</sup> Preheat the appliance.

## Keeping food warm

### Tips for keeping food warm

- Using the "Keep warm" heating function prevents condensation from forming. You will not have to wipe down the cooking compartment.
- Do not cover the food.
- Do not keep food warming for longer than 2 hours.
- Be aware that some types of food will actually continue cooking when you are keeping them warm in the oven.

The different added steam levels are suitable for keeping the following foods warm:

- Level 1: Joints and briefly roasted food
- Level 2: Bakes and side dishes
- Level 3: Stews and soups

## 29.7 Meals and tips for cooking for Great Britain

Recommended settings for meals with British cooking habits.

Also follow the instructions in the individual sections. This section contains only special additional information relating to British meals and cooking habits.

## Baking

### Recommended settings for baking on one level

Food	Accessory/cook-ware	Height	Heating function	Temperature in °C	Steam intensity	Cooking time in mins
Victoria sponge cake	x 2 20 cm diameter cake tin	2		150-160	Low	25-35
Rich fruit cake	Deep, 23 cm diameter tin	2		140-160	-	120-180
Rich fruit cake	Deep, 23 cm diameter tin	2		130-150	-	150-180
Fruit pie	20 cm diameter plate or Pie tin	2		160-170	-	55-70
Fruit pie	20 cm diameter plate or Pie tin	2		170-190	-	60-75
Bread or white bread	Loaf tin, 1 x 900 g or 2 x 450 g	2		190-200	Medium	30-40
Bread or white bread	Loaf tin, 1 x 900 g or 2 x 450 g	2		190-200	-	40-50
Scones	Baking sheet on wire rack	3		180-190 <sup>1</sup>	-	10-14
Biscuits	Baking sheet on wire rack	3		140-160 <sup>1</sup>	-	10-25
Small cakes	12-cup-tin	3		140-160 <sup>2</sup>	-	20-30
Pavlova	Baking sheet on wire rack	3		90-100 <sup>1</sup>	-	120-180
Yorkshire pudding	12-cup-tin	3		200-220 <sup>1</sup>	-	15-25

<sup>1</sup> Preheat the appliance.

<sup>2</sup> Preheat the appliance for five minutes. Do not use the rapid heating function.

### Recommended settings for baking on several levels

Food	Accessory/cook-ware	Height	Heating function	Temperature in °C	Steam intensity	Cooking time in mins
Victoria sponge cake, 2 levels	x 4 20 cm diameter cake tin	3+1		160-170 <sup>1</sup>	-	20-25

<sup>1</sup> Preheat the appliance.

Food	Accessory/cook-ware	Height	Heating function	Temperature in °C	Steam intensity	Cooking time in mins
Biscuits, 2 levels	x 2 Baking sheet on wire rack	3+1		140-160 <sup>1</sup>	-	15-30
Biscuits, 3 levels	x 3 Baking sheet on wire rack	4+3+1		140-160 <sup>1</sup>	-	15-30

<sup>1</sup> Preheat the appliance.

## Grilling

### Recommended settings for meat

Food	Accessory/cook-ware	Height	Heating function	Temperature in °C	Steam intensity	Cooking time in mins
Pork, Bacon rashers <sup>1</sup>	Pan support	3		290 <sup>2</sup>	-	<b>1.</b> 4-5 <b>2.</b> 3-4 <sup>3</sup>
Pork, Sausages, thickness 2-4 cm	Pan support	3		290 <sup>4</sup>	-	10-15 <sup>5</sup>
Pork, Belly	Pan support	2		200-220	-	30+25
Pork, Belly, 1 kg <sup>1</sup>	Pan support	2		<b>1.</b> 170-180 <b>2.</b> 190-200	Low -	<b>1.</b> 50-60 <b>2.</b> 25-35
Pork, Gammon joint	Pan support	2		180-200	-	30+25

<sup>1</sup> Slide the universal pan underneath the wire rack.

<sup>2</sup> Preheat the appliance for 5 minutes.

<sup>3</sup> Turn the food occasionally.

<sup>4</sup> Preheat the appliance for 3 minutes.

<sup>5</sup> Turn the food several times.

### Recommended settings for poultry

Food	Accessory/cook-ware	Height	Heating function	Temperature in °C	Steam intensity	Cooking time in mins
Chicken, whole <sup>1</sup>	Pan support	2		200-220	-	20+15
Chicken, whole, 1,5 kg <sup>1</sup>	Pan support	2		180-190	Medium	65-75

<sup>1</sup> Slide the universal pan underneath the wire rack.

## Roasting and braising

### Cooking tips for roasting and braising

Follow this information when frying or braising poultry or meat.

Calculating the cooking time, e.g. 20+35:

- To calculate the cooking time, assume 20 minutes per 500 g of meat. Then add an extra 35 minutes to that figure.

- For 1.5 kg, the cooking time would therefore be 95 minutes.

Cooking time range, e.g. 10-15:

- Your food will be ready within the specified range of time (in minutes).

### Recommended settings for meat

Food	Accessory/cook-ware	Height	Heating function	Temperature in °C	Steam intensity	Cooking time in mins
Beef, Top side, Top rump	Pan support	2		160-170	-	30+25
Beef, Top side, Top rump 1,5 kg <sup>1</sup>	Pan support	2		170-180	Low	100-120
Lamb, Leg, bone-in	Pan support	2		160-170	-	25+25

<sup>1</sup> Slide the universal pan underneath the wire rack.

Food	Accessory/cook-ware	Height	Heating function	Temperature in °C	Steam intensity	Cooking time in mins
Lamb, Leg, bone-in, 1,5 kg <sup>1</sup>	Pan support	2	☺	180-190	Low	80-90
Pork, Belly	Pan support	2	☺	170-180	-	30+25

<sup>1</sup> Slide the universal pan underneath the wire rack.

### Recommended settings for poultry

Food	Accessory/cook-ware	Height	Heating function	Temperature in °C	Steam intensity	Cooking time in mins
Chicken, whole <sup>1</sup>	Pan support	2	☺	170-180	-	25+15
Chicken, whole, 1,5 kg <sup>1</sup>	Pan support	2	☺	180-190	Medium	65-75
Turkey, crown	Pan support	2	☺	150-160	-	20+15
Turkey, crown, 3 kg <sup>1</sup>	Pan support	2	☺	140-150	Medium	100-140
Turkey, whole, 4-8 kg	Pan support	2	☺	150-160	-	12+12 <sup>2</sup>
Turkey, whole, 7 kg <sup>1</sup>	Pan support	1	☺	<b>1.</b> 140-150 <b>2.</b> 170-180	Medium -	<b>1.</b> 120-150 <b>2.</b> 30-40

<sup>1</sup> Slide the universal pan underneath the wire rack.

<sup>2</sup> Turn the food after approx. one hour.

### Recommended settings for bakes

Food	Accessory/cook-ware	Height	Heating function	Temperature in °C	Steam intensity	Cooking time in mins
Diced meat, e.g. beef, pork, lamb, 500 g meat	Covered cookware	2	☺☺	140	-	100-120
Diced meat, e.g. beef, pork, lamb, 500 g meat	Covered cookware	2	☺	140 <sup>1</sup>	-	100-120

<sup>1</sup> Preheat the appliance.

### Recommended settings for complete meals

Food	Accessory/cook-ware	Height	Heating function	Temperature in °C	Steam intensity	Cooking time in mins
Complete meal with Chicken <sup>1</sup>	x 2 Pan support	4+1	☺	180	-	Chicken: (25+15) + 20
Complete meal with Chicken, 1,5 kg	x 2 Pan support	4+1	☺	180	Low -	65-75

<sup>1</sup> Slide the universal pan underneath the wire rack.

## 29.8 Test dishes

The information in this section is provided for test institutes to facilitate testing of the appliance in accordance with EN 60350-1.

### Baking

- The setting values apply to food that is placed into a cold cooking compartment.
- Take note of the information on preheating in the recommended settings tables. These setting values apply without rapid heat-up.
- For baking, use the lower of the temperatures indicated first.
- Items that are placed in the appliance on baking trays or in baking tins/dishes at the same time will not necessarily be ready at the same time.
- Shelf positions when baking on 2 levels:
  - Universal pan: Shelf position 3
  - Baking tray: Shelf position 1
  - Baking tins on the wire rack:
    - First wire rack: Shelf position 3
    - Second wire rack: Shelf position 1
- Shelf positions when baking on 3 levels:
  - Baking tray: Shelf position 4
  - Universal pan: Shelf position 3
  - Baking tray: Shelf position 1

- Hot water sponge cake
  - When baking on 2 levels, place the springform tins at diagonally opposite corners of the wire racks.
- As an alternative to a pan support, you can also use the Air Fry baking tray offered by us.

### Recommended settings for baking

Food	Accessory/cook-ware	Height	Heating function	Temperature in °C	Steam intensity	Cooking time in mins
Shortbread	Baking tray	3	≡	140-150 <sup>1</sup>	-	25-40
Shortbread	Baking tray	3	⌘	140-150 <sup>1</sup>	-	25-40
Shortbread, 2 levels	Universal pan + Baking tray	3+1	⌘	140-150 <sup>1</sup>	-	30-40
Shortbread, 3 levels	x 2 Baking tray + Universal pan	4+3+1	⌘	130-140 <sup>1</sup>	-	35-55
Small cakes	Baking tray	3	≡	160 <sup>1</sup>	-	20-30
Small cakes	Baking tray	3	⌘	150 <sup>1</sup>	-	25-35
Small cakes, 2 levels	Universal pan + Baking tray	3+1	⌘	150 <sup>1</sup>	-	25-35
Small cakes, 3 levels	x 2 Baking tray + Universal pan	4+3+1	⌘	140 <sup>1</sup>	-	35-45
Hot water sponge cake	Springform cake tin, diameter 26 cm	2	≡	160-170 <sup>2</sup>	-	25-35
Hot water sponge cake	Springform cake tin, diameter 26 cm	2	⌘	160-170 <sup>2</sup>	-	30-40
Hot water sponge cake	Springform cake tin, diameter 26 cm	2	⌘	<b>1.</b> 150-160 <b>2.</b> 150-160	Low -	<b>1.</b> 10 <b>2.</b> 20-25
Hot water sponge cake, 2 levels	x 2 Springform cake tin, diameter 26 cm	3+1	⌘	150-170 <sup>2</sup>	-	30-50

<sup>1</sup> Preheat the appliance for five minutes. Do not use the rapid heating function.

<sup>2</sup> Preheat the appliance. Do not use the rapid heating function.

## Grilling

### Recommended settings for grilling

Food	Accessory/cook-ware	Height	Heating function	Temperature in °C	Steam intensity	Cooking time in mins
Toasting bread	Pan support	4	⚡	290 <sup>1</sup>	-	4-6

<sup>1</sup> Do not preheat the appliance.

# 30 Installation instructions

Observe this information when installing the appliance.



## 30.1 General installation instructions

Follow these instructions before you start installing the appliance.

- The safe operation of this appliance can only be guaranteed if it has been installed to a professional standard in accordance

with these installation instructions. The installer shall be liable for damages incurred as a result of incorrect installation.

- Do not use the door handle for the transport or installation.
  - Check the appliance for damage after unpacking it. Do not connect the appliance if it has been damaged in transit.
  - Before starting up the appliance, remove any packaging material and adhesive film from the cooking compartment and the door.
  - Proceed in accordance with the installation sheets for installing accessories.
  - Fitted units must be heat-resistant up to 95 °C, and adjacent unit fronts up to 70 °C.
  - Do not install the appliance behind a decorative door or the door of a kitchen unit. There is a risk of overheating.
  - Cut-out work on the units should be carried out before installing the appliance. Remove any shavings. Otherwise, the correct operation of electrical components may be adversely affected.
  - The mains socket for the appliance must either be located in the hatched area **a** or outside of the area where the appliance is installed.
- Any unsecured units must be secured to the wall using a standard bracket **b**.

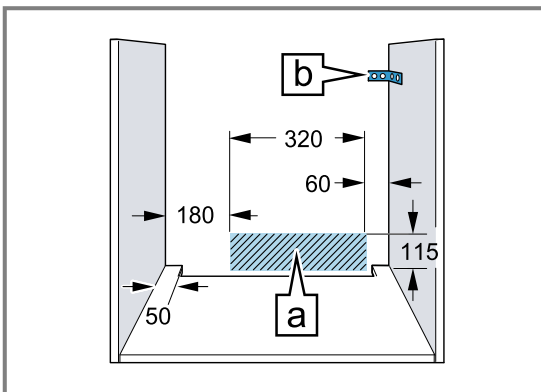

- For appliances that have a hinged switch panel, make sure that the switch panel does not hit adjacent kitchen units when you open it.
- Wear protective gloves so that you do not cut yourself. Parts that are accessible during installation may have sharp edges.
- Dimensions of the figures in mm.

**⚠ WARNING – Risk of fire!**

It is dangerous to use an extended power cord and non-approved adapters.

- ▶ Do not use extension cables or multiple socket strips.
- ▶ Only use adapters and power cords approved by the manufacturer.
- ▶ If the power cord is too short and a longer one is not available, please contact an electrician to have the domestic installation adapted.

**ATTENTION!**

Carrying the appliance by the door handle could break it. The door handle cannot support the weight of the appliance.

- ▶ Do not carry or hold the appliance by the door handle.

**30.2 Appliance dimensions**

You will find the dimensions of the appliance here

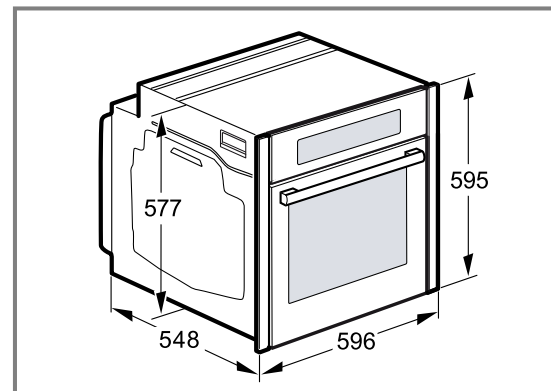

**30.3 Installation below a worktop**

Observe the installation dimensions and the installation instructions when installing below a worktop.

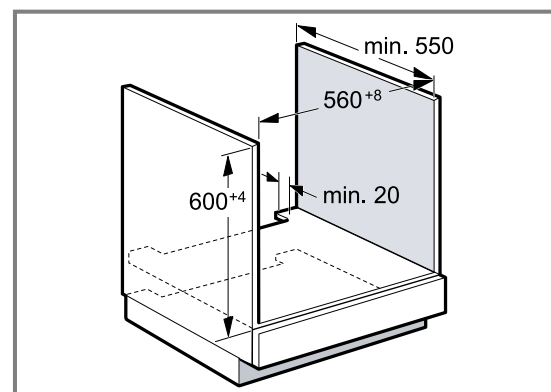

- To ventilate the appliance, the intermediate floor must have a ventilation cut-out.
- The worktop must be secured to the fitted unit.
- Observe any available installation instructions for the hob.
- Observe different national installation instructions for the hob.



### 30.4 Installation underneath a hob

If the appliance is installed under a hob, the following minimum dimensions must be adhered to (including substructure, if applicable).

The minimum worktop thickness  $\boxed{b}$  a is based on the required minimum clearance  $\boxed{a}$ .

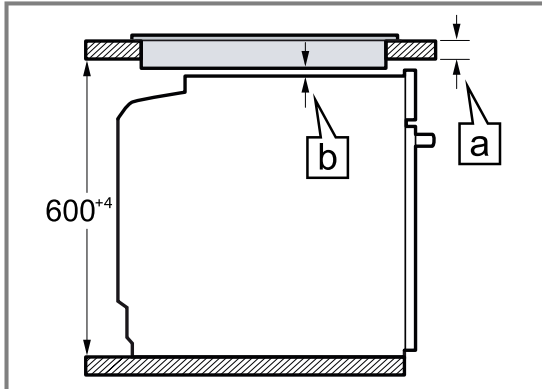

Hob type	a raised in mm	a flush in mm	b in mm
Induction hob	37	38	5
Full-surface induction hob	47	48	5
Gas hob	27	38	5 <sup>1</sup>
Electric hob	27	30	2

<sup>1</sup> Observe different national installation instructions for the hob.

### 30.5 Installation in a tall unit

Observe the installation dimensions and the installation instructions when installing in a tall unit.

### 30.6 Installing two appliances on top of each other

Your appliance can also be installed above or below another appliance. Observe the installation dimensions and the installation instructions when installing appliances on top of each other.

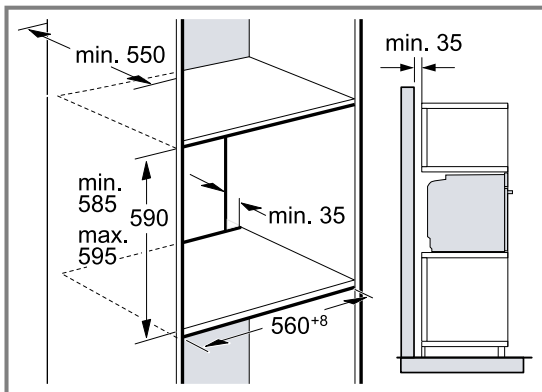

- To ventilate the appliance, the intermediate floors must have a ventilation cut-out.
- If the tall unit has another back panel in addition to the element back panels, this must be removed.
- Only fit the appliance up to a height which allows accessories to be easily removed.

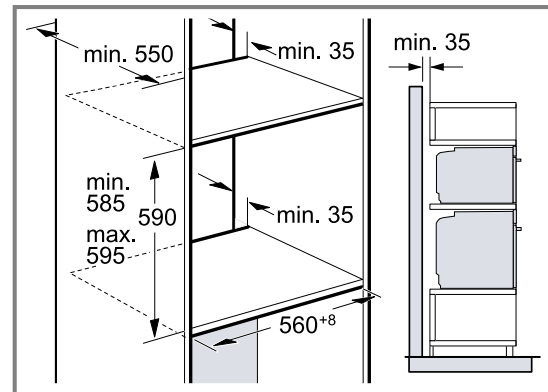

- To ventilate the appliances, the intermediate floor must have a ventilation cut-out.
- To ensure sufficient ventilation of the two appliances, there must be a ventilation opening of at least 200 cm<sup>2</sup> in the base area. To do this, trim the base panel or fit a ventilation grille.

- Ensure that air exchange is guaranteed in accordance with the diagram.



- Only fit appliances up to a height that allows accessories to be easily removed.

### 30.7 Corner installation

Observe the installation dimensions and the installation instructions when installing in a corner.

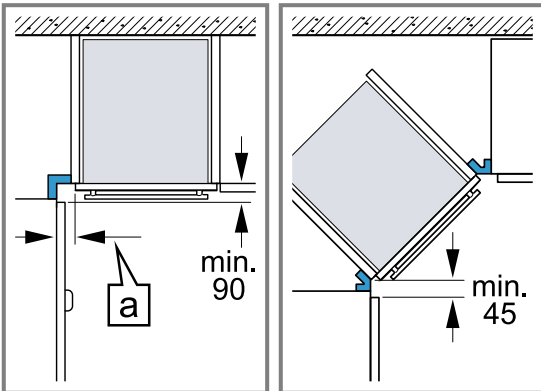

- To ensure that the appliance door can be opened, you must take the minimum dimensions into consideration when installing in a corner. The dimension  $a$  is dependent on the thickness of the unit front and the handle.

### 30.8 Electrical connection

In order to safely connect the appliance to the electrical system, follow these instructions.

- The appliance corresponds to protection class I and must only be operated with a protective earth connection.
- The fuse protection must correspond to the power rating specified on the appliance's rating plate and to the local regulations.
- The appliance must be disconnected from the power supply whenever installation work is being carried out.
- The appliance must only be connected using the power cable provided.
- The power cable must be plugged in at the rear of the appliance until you hear a clicking sound. A 3 m power cable can be obtained from the after-sales service.
- The power cable must only be replaced with a cable from the original manufacturer. This is available from after-sales service.

- Contact protection must be guaranteed by the installation.
- If the display on the appliance remains dark, it has not been connected correctly. Disconnect the appliance from the mains and check the connection.

### Electrically connect the appliance with the protective contact plug

**Note:** The appliance must only be connected to a protective contact socket that has been correctly installed.

- ▶ Insert the plug into the protective contact socket. When the appliance is installed, the mains plug of the power cord must be freely accessible. If free access is not possible, an isolating switch must be integrated into the permanent electrical installation according to the installation regulations.

### Electrically connecting an appliance without a protective contact plug

**Note:** Only licensed specialists may connect the appliance. Damage caused by incorrect connection is not covered under the warranty.

An isolating switch must be integrated into the permanent electrical installation according to the installation regulations.

1. Identify the phase and neutral conductors in the socket. The appliance may be damaged if it is not connected correctly.
2. Connect the hob in accordance with the connection diagram. See the rating plate for the voltage.
3. Connect the wires of the mains power cable according to the colour coding:
  - Green/yellow = Protective conductor  $\oplus$
  - Blue = Neutral conductor
  - Brown = Phase (external conductor)

### 30.9 Installing the appliance

**Note:** Do not use a cordless screwdriver to secure the panels. This may damage the panels.

1. If required, you can adjust the gap between the appliance door and the panels using the adjustment screws on the left and right.

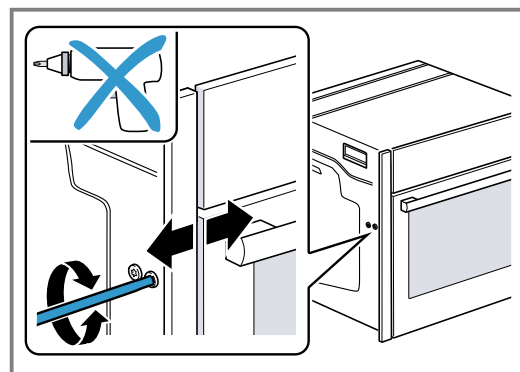

Turning the screws clockwise makes the gap larger  
Turning the screws anti-clockwise makes the gap smaller

2. Push the appliance in fully. Do not kink or trap the connection cable, or route it over sharp edges.

3. Centre the appliance.

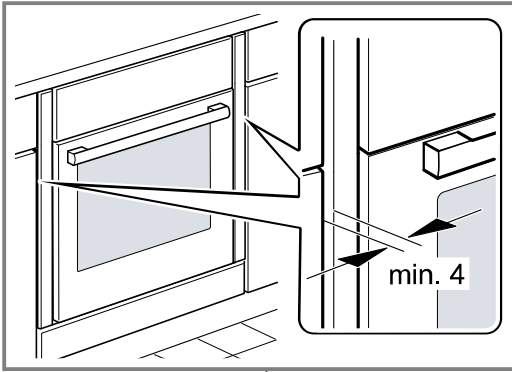

There must be an air gap of at least 4 mm between the appliance and adjacent unit fronts.

4. Open the appliance door slightly and unscrew panels on the left and right.

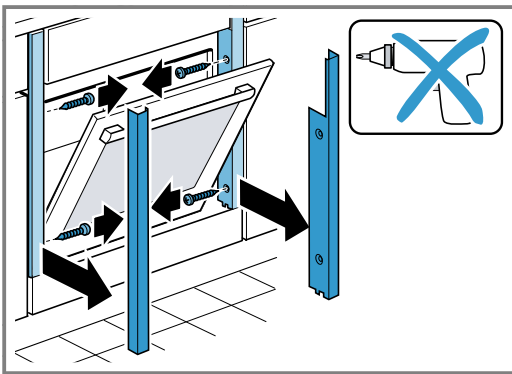

5. Close the appliance door.

6. If required, you can adjust the height of the appliance door using the adjustment screws on the left and right.

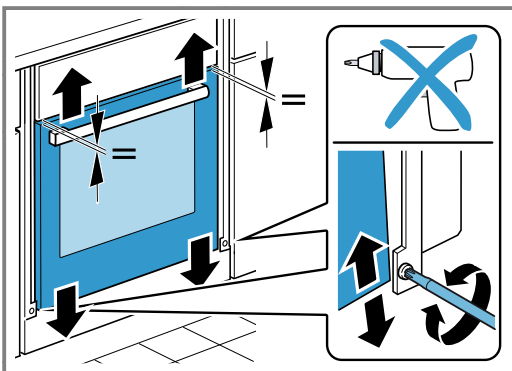

Turning the screws clockwise makes the gap smaller  
Turning the screws anti-clockwise makes the gap larger

7. Screw the appliance into place.

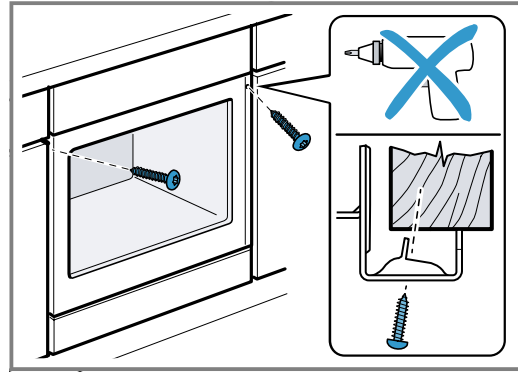

8. Open the appliance door slightly, then refit the panels and screw them in place, first at the top and then at the bottom.

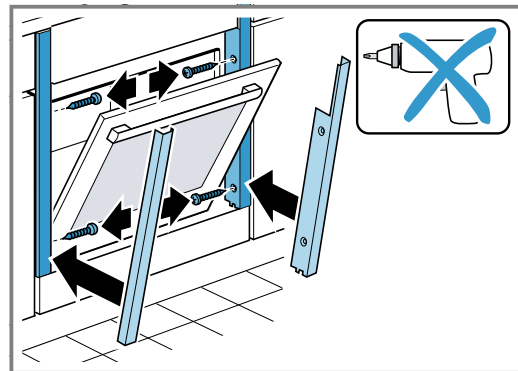

**Note:** The gap between the worktop and the appliance must not be closed by additional battens. Thermal insulation strips must not be fitted to the side panels of the surround unit.

### 30.10 For handleless kitchens with vertical bar handle strips:

1. Attach a suitable filling piece in order to cover any sharp edges and to guarantee a safe installation.

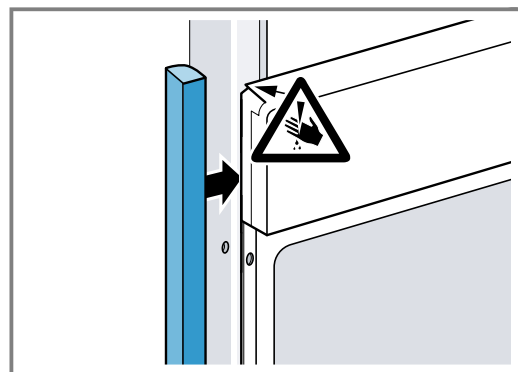

2. Pre-drill aluminium profiles to establish a screw connection.

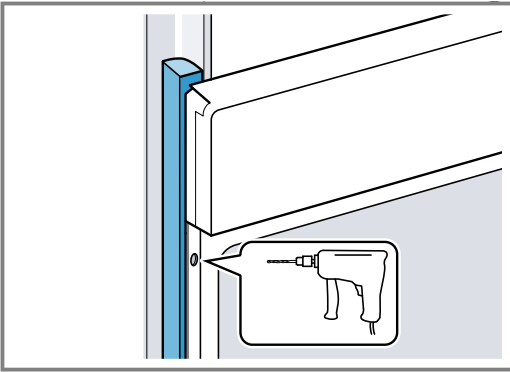

3. Secure the appliance using a suitable screw.

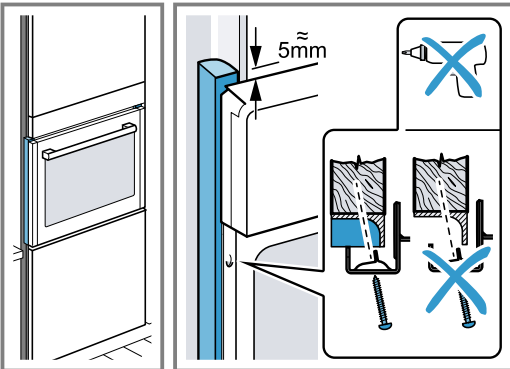

### 30.11 Removing the appliance

1. Disconnect the appliance from the power supply.
2. Open the appliance door slightly and unscrew the left and right-hand panels.
3. Undo the fastening screws.
4. Lift the appliance slightly and pull it out completely.





A series of horizontal lines spanning the width of the page, providing a template for writing.



Valid within Great Britain:  
Imported to Great Britain by  
BSH Home Appliances Ltd.  
Grand Union House  
Old Wolverton Road  
Wolverton, Milton Keynes  
MK12 5PT  
United Kingdom



Register your product online  
[neff-home.com](https://neff-home.com)

**BSH Hausgeräte GmbH**  
Carl-Wery-Straße 34  
81739 München, GERMANY



**9001696286**  
040325  
en

