



Oven

[en] User manual and installation instructions

C28MT27.1





# Further information and explanations are available online:



## Table of contents

### INFORMATION FOR USE

1	<b>Safety</b> .....	2
2	<b>Preventing material damage</b> .....	7
3	<b>Environmental protection and saving energy</b> .....	8
4	<b>Familiarising yourself with your appliance</b> .....	9
5	<b>Accessories</b> .....	12
6	<b>Before using for the first time</b> .....	13
7	<b>Basic operation</b> .....	13
8	<b>Time-setting options</b> .....	14
9	<b>Microwave</b> .....	15
10	<b>Microwave programmes</b> .....	18
11	<b>Meat probe</b> .....	19
12	<b>Baking and roasting assistant</b> .....	21
13	<b>Childproof lock</b> .....	21
14	<b>Rapid heating</b> .....	22
15	<b>Sabbath mode</b> .....	22
16	<b>Basic settings</b> .....	23
17	<b>Cleaning and servicing</b> .....	24
18	<b>Cleaning functions</b> .....	26
19	<b>Rails</b> .....	28
20	<b>Appliance door</b> .....	29
21	<b>Troubleshooting</b> .....	30
22	<b>Disposal</b> .....	32
23	<b>Customer Service</b> .....	32
24	<b>How it works</b> .....	32
25	<b>INSTALLATION INSTRUCTIONS</b> .....	41
25.1	<b>General installation instructions</b> .....	41

## 1 Safety

Observe the following safety instructions.

### 1.1 General information

- Read this instruction manual carefully.
- Keep the instruction manual and the product information safe for future reference or for the next owner.
- Do not connect the appliance if it has been damaged in transit.

### 1.2 Intended use

This appliance is designed only to be built into kitchen units. Read the special installation instructions.

Only a licensed professional may connect appliances without plugs. Damage caused by incorrect connection is not covered under the warranty.

Only use this appliance:

- To prepare meals and drinks.
- For household use and similar applications, such as: In kitchens for employees in shops, offices and other commercial sectors; in agriculture; by customers in hotels and other residential facilities; in bed and breakfasts.
- Up to an altitude of max. 4000 m above sea level.

This appliance complies with the standards EN 55011 and CISPR 11. It is a group 2, class B product. Group 2 means that microwaves are produced for the purpose of heating food. Class B means that the appliance is suitable for private households.

### 1.3 Restriction on user group

This appliance may be used by children aged 8 or over and by people who have reduced physical, sensory or mental abilities or inadequate experience and/or knowledge, provided that they are supervised or have

been instructed on how to use the appliance safely and have understood the resulting dangers.

Do not let children play with the appliance. Children must not perform cleaning or user maintenance unless they are at least 15 years old and are being supervised.

Keep children under the age of 8 years away from the appliance and power cable.

#### 1.4 Safe use

Always place accessories in the cooking compartment the right way round.

→ "Accessories", Page 12

#### **⚠ WARNING – Risk of fire!**

Combustible objects that are left in the cooking compartment may catch fire.

- ▶ Never store combustible objects in the cooking compartment.
- ▶ If smoke is emitted, the appliance must be switched off or the plug must be pulled out and the door must be held closed in order to stifle any flames.

Loose food remnants, fat and meat juices may catch fire.

- ▶ Before using the appliance, remove the worst of the food residues and remnants from the cooking compartment, heating elements and accessories.

Opening the appliance door creates a draught. Greaseproof paper may come into contact with the heating element and catch fire.

- ▶ Never place greaseproof paper loosely over accessories when preheating the appliance and while cooking.
- ▶ Always cut greaseproof paper to size and use a plate or baking tin to hold it down.

#### **⚠ WARNING – Risk of burns!**

The appliance and its parts that can be touched become hot during use.

- ▶ Caution should be exercised here in order to avoid touching heating elements.
- ▶ Young children under 8 years of age must be kept away from the appliance.

Accessories and cookware get very hot.

- ▶ Always use oven gloves to remove accessories or cookware from the cooking compartment.

When the cooking compartment is hot, any alcoholic vapours inside may catch fire. The appliance door may spring open. Hot steam and jets of flame may escape.

- ▶ Only use small quantities of drinks with a high alcohol content in food.
- ▶ Do not heat spirits ( $\geq 15\%$  vol.) when undiluted (e.g. for marinating or pouring over food).
- ▶ Open the appliance door carefully. The telescopic shelves become hot when the appliance is in use.
- ▶ Allow hot telescopic shelves to cool down before touching them.
- ▶ Only touch hot telescopic shelves with oven gloves.

#### **⚠ WARNING – Risk of scalding!**

The accessible parts of the appliance become hot during operation.

- ▶ Never touch these hot parts.
- ▶ Keep children at a safe distance.

Hot steam may escape when you open the appliance door. Steam may not be visible, depending on the temperature.

- ▶ Open the appliance door carefully.
- ▶ Keep children at a safe distance.

If there is water in the cooking compartment when it is hot, this may create hot steam.

- ▶ Never pour water into the cooking compartment when the cooking compartment is hot.

#### **⚠ WARNING – Risk of injury!**

Scratched glass in the appliance door may develop into a crack.

- ▶ Do not use any harsh or abrasive cleaners or sharp metal scrapers to clean the glass on the oven door, as they may scratch the surface.

The appliance and its parts that can be touched may have sharp edges.

- ▶ Take care when handling and cleaning them.
- ▶ If possible, wear protective gloves.

The hinges on the appliance door move when the door is opened and closed, which could trap your fingers.

- ▶ Keep your hands away from the hinges. Components inside the appliance door may have sharp edges.
- ▶ Wear protective gloves.

Alcoholic vapours may catch fire in the hot cooking compartment, and the appliance door may spring open and may fall off. The door panels may shatter and fragment.

→ "Preventing material damage", Page 7

- ▶ Only use small quantities of drinks with a high alcohol content in food.
- ▶ Do not heat spirits ( $\geq 15\%$  vol.) when undiluted (e.g. for marinating or pouring over food).
- ▶ Open the appliance door carefully.

### **⚠ WARNING – Risk of electric shock!**

Incorrect repairs are dangerous.

- ▶ Repairs to the appliance should only be carried out by trained specialist staff.
- ▶ Only use genuine spare parts when repairing the appliance.
- ▶ If the power cord of this appliance is damaged, it must be replaced by the manufacturer, the manufacturer's Customer Service or a similarly qualified person in order to prevent any risk.

If the insulation of the power cord is damaged, this is dangerous.

- ▶ Never let the power cord come into contact with hot appliance parts or heat sources.
- ▶ Never let the power cord come into contact with sharp points or edges.
- ▶ Never kink, crush or modify the power cord.

An ingress of moisture can cause an electric shock.

- ▶ Do not use steam- or high-pressure cleaners to clean the appliance.

If the appliance or the power cord is damaged, this is dangerous.

- ▶ Never operate a damaged appliance.
- ▶ Never pull on the power cord to unplug the appliance. Always unplug the appliance at the mains.
- ▶ If the appliance or the power cord is damaged, immediately unplug the power cord or switch off the fuse in the fuse box.
- ▶ Call customer services. → Page 32

### **⚠ WARNING – Danger: Magnetism!**

Permanent magnets are used in the control panel or in the controls. These may affect electronic implants, e.g. heart pacemakers or insulin pumps.

- ▶ Wearers of electronic implants must stay at least 10 cm away from the control panel.

### **⚠ WARNING – Risk of suffocation!**

Children may put packaging material over their heads or wrap themselves up in it and suffocate.

- ▶ Keep packaging material away from children.
- ▶ Do not let children play with packaging material.

Children may breathe in or swallow small parts, causing them to suffocate.

- ▶ Keep small parts away from children.
- ▶ Do not let children play with small parts.

## **1.5 Microwave**

CAREFULLY READ THE IMPORTANT SAFETY INSTRUCTIONS AND KEEP THEM SAFE FOR FUTURE USE

### **⚠ WARNING – Risk of fire!**

Using the appliance for anything other than its intended purpose is dangerous and may cause damage. For example, heated slippers and pillows filled with grain or cereal may catch fire, even several hours later.

- ▶ Never dry food or clothing with the appliance.
- ▶ Never heat up slippers, pillows filled with grain or cereal, sponges, damp cleaning cloths or similar with the appliance.
- ▶ The appliance must only be used to prepare food and drink.

Food and its packaging and containers may catch fire.

- ▶ Never heat food in heat-retaining packaging.
- ▶ Do not leave food unattended while it is heating in containers made of plastic, paper or other combustible materials.
- ▶ Never set the microwave power too high or the cooking time too long. Follow the instructions provided in this user manual.
- ▶ Never use the microwave to dry food.
- ▶ Never defrost or heat food with a low water content, such as bread, at too high a microwave power or for too long.

Cooking oil may catch fire.

- ▶ Never use the microwave to heat cooking oil on its own.

**⚠ WARNING – Risk of explosion!**

Liquids and other food may easily explode when in containers that have been tightly sealed.

- ▶ Never heat liquids or other food in containers that have been tightly sealed.

**⚠ WARNING – Risk of burns!**

Foods with peel or skin may burst or explode during heating, or even afterwards.

- ▶ Never cook eggs in their shell or heat hard-boiled eggs in their shell.
- ▶ Never cook shellfish or crustaceans.
- ▶ Always prick the yolk of eggs before microwaving.
- ▶ The skin of foods that have a peel or skin, such as apples, tomatoes, potatoes and sausages, may burst. Before heating, prick the peel or skin.

Heat is not distributed evenly through baby food.

- ▶ Never heat baby food in closed containers.
- ▶ Always remove the lid or teat.
- ▶ Stir or shake well after heating.
- ▶ Check the temperature before giving the food or drink to a child.

Heated food gives off heat. The cookware may become hot.

- ▶ Always use oven gloves to remove cookware or accessories from the cooking compartment.

Airtight packaging may burst when food is heated.

- ▶ Always follow the instructions on the packaging.
- ▶ Always use oven gloves to remove the dishes from the cooking compartment.

The accessible parts of the appliance become hot during operation.

- ▶ Never touch these hot parts.
- ▶ Keep children at a safe distance.

At the highest settings in microwave only mode, the drying function will automatically switch on an additional heating element to heat the cooking compartment.

- ▶ Never touch the inside surfaces of the cooking compartment or the heating elements while they are hot.
- ▶ Keep children at a safe distance.

Using the appliance for anything other than its intended purpose is dangerous. This is because, for instance, overheated slippers, pillows filled with grain or cereal, sponges and damp cleaning cloths, etc., may cause burns to the skin.

- ▶ Never dry food or clothing with the appliance.
- ▶ Never heat up slippers, pillows filled with grain or cereal, sponges, damp cleaning cloths or similar with the appliance.
- ▶ The appliance must only be used to prepare food and drink.

**⚠ WARNING – Risk of scalding!**

There is a possibility of delayed boiling when a liquid is heated. This means that the liquid reaches the boiling temperature without the usual steam bubbles rising to the surface. Exercise caution even when only gently shaking the container. The hot liquid may suddenly boil over and splatter.

- ▶ Always place a spoon in the container when heating liquids. This prevents delayed boiling.

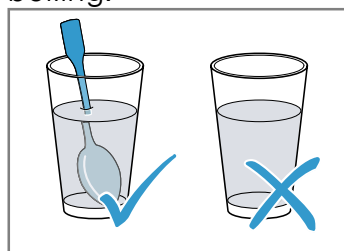
**⚠ WARNING – Risk of injury!**

Unsuitable cookware may crack. Porcelain or ceramic cookware can have small perforations in the handles and lid. These perforations conceal a cavity below. If moisture penetrates this cavity, it could cause the cookware to crack.

- ▶ Only use microwave-safe cookware. Cookware and containers made from metal or cookware with metal edging may lead to sparks being formed during simple microwave operation. The appliance is damaged.
- ▶ Never use metal containers during microwave-only operation.
- ▶ Only use microwave-safe cookware or use the microwave in combination with a type of heating.

**⚠ WARNING – Risk of electric shock!**

The appliance uses a high voltage.

- ▶ Never remove the casing.

**⚠ WARNING – Risk of serious harm to health!**

Inadequate cleaning may destroy the surface of the appliance, reduce its service life, and lead to dangerous situations, such as escaping microwave energy.

- ▶ Clean the appliance on a regular basis, and remove any food residue immediately.
- ▶ Always keep the cooking compartment, door seal, door and door stop clean.  
→ "Cleaning and servicing", Page 24

Never operate the appliance if the cooking compartment door or the door seal is damaged. Microwave energy may escape.

- ▶ Never use the appliance if the cooking compartment door, the door seal or the plastic door frame is damaged.
- ▶ Any repair work must only be carried out by the after-sales service.

Microwave energy will escape from appliances that do not have any casing.

- ▶ Never remove the casing.
- ▶ Contact our after-sales service if maintenance or repair work is needed.

## 1.6 Meat probe

**⚠ WARNING – Risk of electric shock!**

Using the wrong meat probe could damage the insulation.

- ▶ Only use the meat probe for this specific appliance.

## 1.7 Cleaning function

**⚠ WARNING – Risk of fire!**

Loose food remnants, fat and meat juices may catch fire when the cleaning function is in progress.

- ▶ Before you start the cleaning function, always remove coarse dirt from the cooking compartment.
- ▶ Never clean accessories at the same time.

The outside of the appliance gets very hot when the cleaning function is in progress.

- ▶ Never hang combustible objects, e.g. tea towels, on the door handle.
- ▶ Leave the front of the appliance clear.
- ▶ Keep children at a safe distance.

If the door seal is damaged, a large amount of heat is generated around the door.

- ▶ Do not scrub or remove the seal.
- ▶ Never operate the appliance if the seal is damaged or missing.

**⚠ WARNING – Risk of serious harm to health!**

The appliance gets very hot when the cleaning function is in progress. The non-stick coating on baking trays and tins is destroyed and noxious gases are released.

- ▶ Never clean non-stick baking trays or baking tins using the cleaning function.
- ▶ Never clean accessories at the same time.

**⚠ WARNING – Risk of harm to health!**

The cleaning function heats up the cooking compartment to a very high temperature so that food left over from roasting, grilling and baking will burn off. This process releases vapours, which can irritate mucous membranes.

- ▶ Keep the kitchen well ventilated while the cleaning function is running.
- ▶ Do not remain in the room for long periods.
- ▶ Keep children and pets away.

**⚠ WARNING – Risk of burns!**

The cooking compartment gets very hot when the cleaning function is in progress.

- ▶ Never open the appliance door.
- ▶ Allow the appliance to cool down.
- ▶ Keep children at a safe distance.

**⚠** The outside of the appliance gets very hot when the cleaning function is in progress.

- ▶ Never touch the appliance door.
- ▶ Allow the appliance to cool down.
- ▶ Keep children at a safe distance.

## 2 Preventing material damage

### 2.1 General

#### ATTENTION!

Alcoholic vapours may catch fire in the hot cooking compartment and cause permanent damage to the appliance. The appliance door may spring open due to an explosion and it may fall off. The door panels may shatter and fragment. Due to the resulting negative pressure, the cooking compartment may become considerably deformed inwards.

- ▶ Do not heat spirits ( $\geq 15\%$  vol.) when undiluted (e.g. for marinating or pouring over food).

If there is water on the cooking compartment floor when operating the appliance at temperatures above  $120\text{ }^{\circ}\text{C}$ , this will damage the enamel.

- ▶ Do not use the appliance if there is water on the cooking compartment floor.
- ▶ Wipe away any water on the cooking compartment floor before operation.

Objects on the cooking compartment floor at over  $50\text{ }^{\circ}\text{C}$  will cause heat to build up. The baking and roasting times will no longer be correct and the enamel will be damaged.

- ▶ Do not place any accessories, greaseproof paper or foil of any kind on the cooking compartment floor.
- ▶ Only place cookware on the cooking compartment floor if a temperature above  $50\text{ }^{\circ}\text{C}$  has been set.

When the cooking compartment is hot, any water inside it will create steam. The change in temperature may cause damage.

- ▶ Never pour water into the cooking compartment when it is still hot.
- ▶ Never place cookware containing water on the cooking compartment floor.

The prolonged presence of moisture in the cooking compartment leads to corrosion.

- ▶ Allow the cooking compartment to dry after use.
- ▶ Do not keep moist food in the cooking compartment for a long time with the door closed.
- ▶ Do not store food in the cooking compartment.

Leaving the appliance to cool down with the door open will damage the front of neighbouring kitchen units over time.

- ▶ Always allow the cooking compartment to cool down with the door closed after cooking at high temperatures.
- ▶ Take care not to trap anything in the appliance door.
- ▶ Only leave the cooking compartment to dry with the door open if a lot of moisture was produced during operation.

Fruit juice dripping from the baking tray leaves stains that cannot be removed.

- ▶ When baking very juicy fruit flans, do not pack too much on the baking tray.
- ▶ If possible, use the deeper universal pan.

Using oven cleaner in a hot cooking compartment damages the enamel.

- ▶ Never use oven cleaner in the cooking compartment when it is still warm.
- ▶ Remove all food remnants from the cooking compartment and the appliance door before you next heat up the appliance.

If the seal is very dirty, the appliance door will no longer close properly during operation. This may damage the front of adjacent kitchen units.

- ▶ Keep the seal clean at all times.
- ▶ Never operate the appliance if the seal is damaged or missing.

Sitting or placing objects on the appliance door may damage it.

- ▶ Do not place, hang or support objects on the appliance door.
- ▶ Do not place cookware or accessories on the appliance door.

With certain models, accessories may scratch the door pane when closing the appliance door.

- ▶ Always push accessories fully into the cooking compartment.

### 2.2 Microwave

Follow these instructions when using the microwave.

#### ATTENTION!

Metal touching the wall of the cooking compartment will cause sparks, which may damage the appliance or the inner door pane.

- ▶ Metal (e.g. a spoon in a glass) must be kept at least 2 cm from the cooking compartment walls and the inside of the door.

Using accessories directly on top of one another causes sparks.

- ▶ Do not combine the wire rack with the universal pan.
- ▶ Always place accessories on different levels.

The universal pan and baking tray are not suitable for use with microwave-only mode. Using either of these may create sparks, which will damage the cooking compartment.

- ▶ Place accessories on the wire rack supplied.
- ▶ Placing aluminium containers in the appliance may cause sparks, which will damage the appliance.

Operating the appliance without food in the cooking compartment may lead to overloading.

- ▶ Do not switch on the microwave unless there is food inside. The only exception to this rule is when performing a short cookware test.

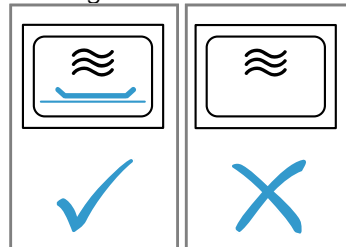

If you prepare microwave popcorn at a microwave power level that is too high, the door pane may crack due to overloading.

- ▶ Never set a microwave power level that is too high.
- ▶ Use a maximum microwave output of 600 watts.
- ▶ Always place the popcorn bag on a glass plate.

## 3 Environmental protection and saving energy

### 3.1 Disposing of packaging

The packaging materials are environmentally compatible and can be recycled.

- ▶ Sort the individual components by type and dispose of them separately.

### 3.2 Saving energy

If you follow these instructions, your appliance will use less power.

Only preheat the appliance if the recipe or the recommended settings tell you to do so.

- Not preheating the appliance can reduce the energy used by up to 20%.

Use dark-coloured, black-coated or enamelled baking tins.

- These types of baking tin absorb the heat particularly well.

Open the appliance door as little as possible during operation.

- This maintains the temperature in the cooking compartment and eliminates the need for the appliance to reheat.

When baking multiple dishes, do so in succession or in parallel.

- The cooking compartment is heated after baking the first dish. This reduces the baking time for the second cake.

If the cooking time is relatively long, you can switch the appliance off 10 minutes before the cooking time ends.

- There will be enough residual heat to finish cooking the dish.

Remove any accessories that are not being used from the cooking compartment.

- Accessories that are not being used do not need to be heated.

Allow frozen food to defrost before cooking.

- This saves the energy that would otherwise be required to defrost it.

#### **Note:**

The appliance requires:

- A maximum of 1 W when the appliance is in operation with the display switched on
- A maximum of 0.5 W when the appliance is in operation with the display switched off



## 4 Familiarising yourself with your appliance

### 4.1 Control panel

You can use the control panel to configure all functions of your appliance and to obtain information about the operating status.

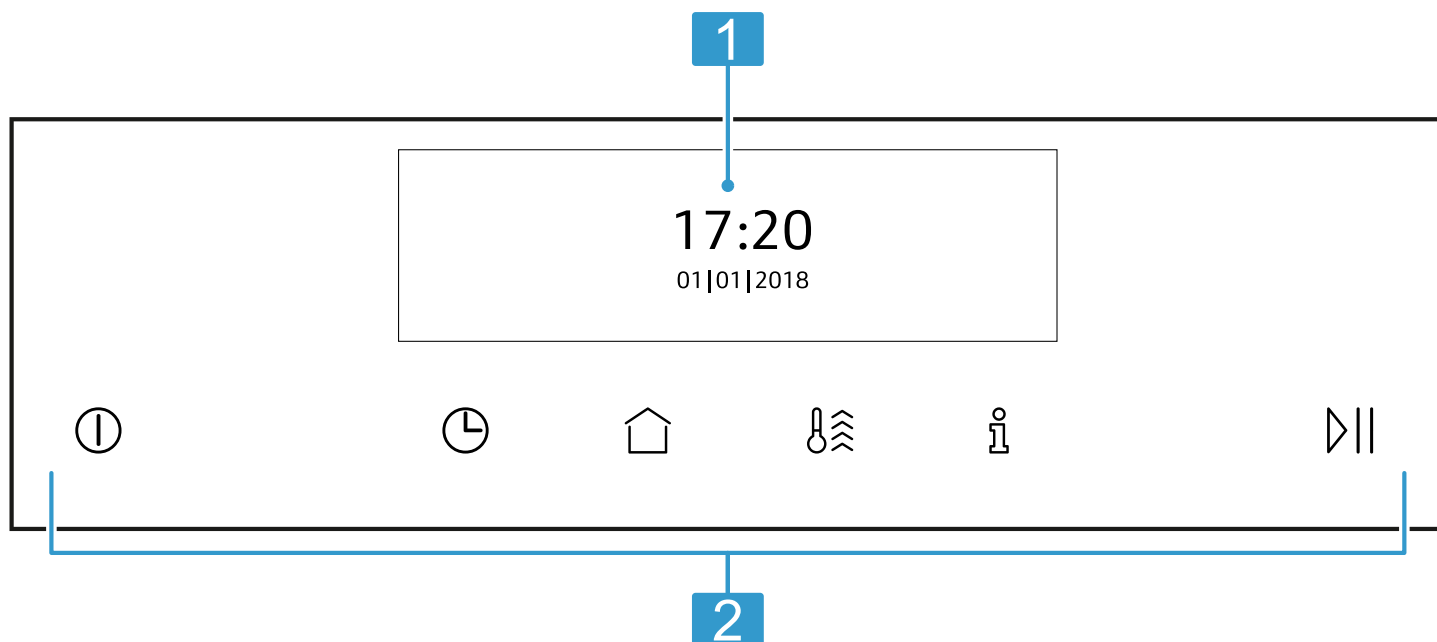

**1** Display

**2** Buttons

### 4.2 Buttons

The buttons are touch-sensitive areas. To select a function, press the corresponding button.

Symbol	Name	Use
ⓘ	On/off	Switch the appliance on or off
🕒	Time-setting options/ childproof lock	<ul style="list-style-type: none"> <li>Set the "timer", "cooking time" or "Ready at" time for delayed starts</li> <li>Activate or deactivate the "childproof lock"</li> </ul>
🏠	Main menu	Select operating modes and settings
🔥	Rapid heat-up	<ul style="list-style-type: none"> <li>Activate or deactivate the "Rapid heat-up" function</li> <li>Activate or deactivate the "PowerBoost" function</li> </ul>
ℹ️	Information	<ul style="list-style-type: none"> <li>View additional information</li> <li>View the current temperature</li> </ul>
▶	Start/stop	Start or pause the appliance

### 4.3 Display

The display shows the current settings, options or relevant information.

#### Control

You can configure all the functions on your appliance via the display.

To adjust a setting, touch the appropriate place on the display with your finger. The settings area will then be displayed more brightly. Swipe left or right over this settings area on the display with your finger until the required setting is magnified.

Direction	Use
Navigate to the left	Swipe right on the display with your finger









Direction	Use
Navigate to the right	Swipe left on the display with your finger

Direction	Use
Navigate upwards	Swipe down on the display with your finger
Navigate downwards	Swipe up on the display with your finger

## 4.4 Main menu

The main menu provides an overview of your appliance's functions.









Press the  button to open the main menu.





Function	Name	Use
	Types of heating	Select the required type of heating and temperature for your food
	Microwave	Use the microwave to cook, heat up or defrost food quickly
	Microwave combination	Switch on the microwave for a type of heating
	Baking and roasting assistant	Recommended settings for baking and roasting
	Microwave programmes	Use the microwave to cook food
	MyProfile	Individually adjust the appliance settings
	Dry	Dry the cooking compartment after using the microwave
	EasyClean	Clean less stubborn dirt from the cooking compartment
	Pyrolytic self-cleaning	Clean the cooking compartment

## 4.5 Types of heating

This is where you will find an overview of the types of heating. You will find recommendations for using the types of heating.

For temperatures above 275 °C, the appliance reduces the temperature to approx. 275 °C after around 40 minutes.

Symbol	Heating function	Temperature	Use
	Hot air	30 - 275 °C	Bake or roast on one or more levels. The fan distributes the heat from the ring-shaped heating element in the back wall evenly around the cooking compartment.
	Top/bottom heating	50 - 275 °C	Traditionally bake or roast on one level. This type of heating is especially good for cakes with moist toppings. The heat is emitted evenly from above and below.
	Circo-roasting	50 - 250 °C	Roast poultry, whole fish or larger pieces of meat. The grill element and the fan switch on and off alternately. The fan circulates the hot air around the food.
	Pizza setting	50 - 275 °C	Cook pizza or food that requires a lot of heat from below. The bottom heating element and the ring-shaped heating element in the back wall heat the cooking compartment.
	Full-surface grill	50 - 290 °C	For grilling flat items such as steaks, sausages or bread, and for cooking au gratin. The entire area below the grill element becomes hot.
	Centre-area grill	50 - 290 °C	For grilling small amounts of steaks, sausages or bread, and for cooking au gratin. The central area below the grill element becomes hot.
	Bottom heating	50 - 250 °C	For cooking in a bain marie and for baking food for extra time. The heat is emitted from below.
	Slow cooking	70 - 120 °C	For gentle, slow cooking of seared, tender pieces of meat in cookware without a lid. The heat is emitted evenly from above and below at a low temperature.

Symbol	Heating function	Temperature	Use
	Dough proving	35 - 55 °C	For proving dough and culturing yoghurt. Dough will prove more quickly than at room temperature. The surface of the dough does not dry out.
	Preheat cookware	30 - 70 °C	For heating cookware.
	Keep warm	60 - 100 °C	For keeping cooked food warm.
	Top/bottom heating eco	50 - 275 °C	For gently cooking selected types of food. Heat is emitted from above and below. This type of heating is most effective between 150 and 250 °C. This type of heating is used to determine the energy consumption in the conventional mode.
	Hot air eco	30 - 275 °C	For gently cooking selected types of food on one level without preheating. The fan distributes the heat from the ring-shaped heating element in the back wall around the cooking compartment. This type of heating is most effective between 125 and 200 °C. This type of heating is used to determine the energy consumption in circulating-air mode and the energy efficiency class.

## 4.6 Microwave power settings

This is where you can find an overview of the different microwave power settings and when to use them. The microwave power settings are levels and do not always correspond to the exact wattage that the appliance uses.

Microwave power setting in watts	Maximum cooking time in hours	Use
90 W	1:30	Defrost delicate foods.
180 W	1:30	Defrost food and continue cooking.
360 W	1:30	Cook fish and meat. Heat up delicate foods.
600 W	1:30	Heat and cook food.
Max.	0:30	Heat liquids.

**Note:** The maximum microwave power setting is not designed for heating food. To protect the appliance, the maximum power of the microwave is gradually reduced to 600 watts during the first few minutes. Full power is made available again after a cooling period.

## 4.7 Cooking compartment

The functions in the cooking compartment make your appliance easier to use.

### Shelf supports

The rails in the cooking compartment enable you to place accessories at different heights.

→ "Accessories", Page 12

Your appliance has three shelf positions. The shelf positions are numbered from bottom to top.

The rails are equipped with pull-out rails on one or more levels, depending on the appliance type.

You can remove the rails, e.g. for cleaning.

→ "Rails", Page 28

### Lighting

One or more oven lights illuminate the cooking compartment.

When you open the appliance door, the light in the cooking compartment switches on. If the appliance door remains open for longer than 15 minutes, the light switches off again.

For most operating modes, the lighting is switched on during operation. The lighting switches off again when the operation ends.

### Cooling fan

The cooling fan switches on and off depending on the appliance's temperature. The hot air escapes above the door.

#### ATTENTION!

Do not cover the ventilation slot above the appliance door. The appliance overheats.

- ▶ Ensure that the ventilation slots are unobstructed.

To ensure that the appliance cools down more quickly after operation, the cooling fan continues to run for a certain period afterwards.

### Appliance door

If you open the appliance door during operation, the operation stops. When you close the appliance door, the operation continues automatically.

In microwave mode, when you close the appliance door, you have to press  to continue.



## 5 Accessories

Use original accessories. These have been made especially for your appliance.

**Note:** Accessories may become deformed if they get hot. Deformation has no effect on function. As the accessory cools down, it will regain its original shape.

The accessories supplied may differ depending on the appliance model.

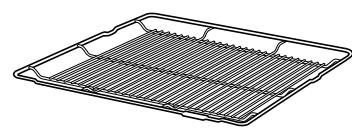
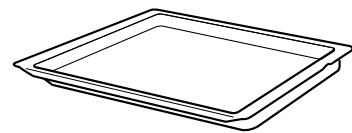
Accessories		Use
Wire rack		<ul style="list-style-type: none"> <li>■ Cake tins</li> <li>■ Ovenproof dishes</li> <li>■ Cookware</li> <li>■ Meat, e.g. roasting joints or steak</li> <li>■ Frozen meals</li> </ul>
Universal pan		<ul style="list-style-type: none"> <li>■ Moist cakes</li> <li>■ Baked items</li> <li>■ Bread</li> <li>■ Large roasts</li> <li>■ Frozen meals</li> <li>■ Catch dripping liquids, e.g. fat when grilling food on the wire rack.</li> </ul>

### 5.1 Information on accessories

Some accessories are only suitable for certain types of heating.

#### Microwave accessories

The wire rack that is supplied is only suitable for operation solely using the microwave.

Baking trays, e.g. the universal pan or the baking tray, may create sparks and are not suitable.

Observe the information about the microwave.

→ "Cookware and accessories with microwave", Page 15

### 5.2 Locking function

The locking function prevents the accessories from tilting when they are pulled out.

You can pull out the accessories approximately halfway without them tipping. The accessories must be inserted into the cooking compartment correctly for the tilt protection to work properly.

### 5.3 Sliding accessories into the cooking compartment

Always slide the accessory into the cooking compartment the right way round. This is the only way to ensure that accessories can be pulled out approximately halfway without tipping.

1. Turn the accessories so that the notch  is at the rear and is facing downwards.
2. Insert the accessory between the two guide rods for a shelf position.

#### Wire rack

Baking tray Slide the tray in with the sloping edge  towards the appliance door.  
E.g. universal pan or baking tray

3. To place the accessory at shelf positions with pull-out rails, pull out the pull-out rails.

Wire rack Position the accessory so that its or baking edge is behind the lug  on the pull-tray out rail.

**Note:** Gently push the pull-out rails back into the cooking compartment.

4. Push the accessory all the way in, making sure that it does not touch the appliance door.

**Note:** Take any accessories that you will not be using out of the cooking compartment while the appliance is in operation.

### 5.4 Other accessories

You can purchase other accessories from our after-sales service, specialist retailers or online.

You will find a comprehensive range of products for your appliance in our brochures and online:

[www.neff-international.com](http://www.neff-international.com)

Accessories vary from one appliance to another. When purchasing accessories, always quote the exact product number (E no.) of your appliance.

You can find out which accessories are available for your appliance in our online shop or from our after-sales service.

## 6 Before using for the first time

Configure the settings for initial start-up. Clean the appliance and accessories.

### 6.1 Initial use

When the appliance is connected to the power supply for the first time or following a lengthy power failure, the settings that you will need to configure before you can use it will appear.

**Note:** You can change these settings at any time by going to the basic settings.  
→ "Basic settings", Page 23

#### Setting the language

1. Connect the appliance to the power supply.
  - ✓ The first setting will appear after a few seconds.
2. Press the bottom row.
3. Swipe left or right to select the required language.
4. Press the top row.

#### Setting the time

1. Press "Time".
2. Press the bottom row.
3. Swipe left or right to select the correct hour.
4. Press "Minutes".
5. Swipe left or right to select the correct number of minutes.
6. Use the  button to save your settings.

#### Setting the date

1. Press "Date".
2. Press the bottom row.
3. Swipe left or right to select the correct day.
4. Press "Month".
5. Swipe left or right to select the correct month.
6. Press "Year".
7. Swipe left or right to select the correct year.
8. Use the  button to save your settings.

## 7 Basic operation

### 7.1 Switching on the appliance

- ▶ Press  to switch the appliance on.

#### Notes

- In the basic settings, you can specify whether the heating functions or the main menu should appear when you switch on the appliance.  
→ "Basic settings", Page 23
- If you do not perform any actions on the appliance for an extended period, it will automatically switch itself off.

### 7.2 Switching off the appliance

- ▶ Press  to switch the appliance off.

#### Notes

- The residual heat indicator will appear on the display while the cooking compartment is still hot.  
→ "Residual heat indicator", Page 13
- The cooling fan will continue to run until the cooking compartment has cooled down.  
→ "Cooling fan", Page 11

### 7.3 Residual heat indicator

After you have switched off the appliance, the residual heat indicator will appear on the display.

Display	Temperature
Residual heat high	Over 120 °C
Residual heat low	Between 60 and 120 °C

### 7.4 Setting the type of heating and temperature

1. Press  to switch the appliance on.
  - ✓ The heating functions will then be displayed.
2. Swipe left or right until the required heating function appears in the middle.

3. Press the temperature.

4. Swipe left or right until the required temperature appears in the middle.

5. Press  to start.

- ✓ The cooking time will appear on the display.
  - ✓ The heat-up indicator bar visualises the rising temperature.
6. When the food is ready, press  to switch the appliance off.

### 7.5 Changing the temperature

You can also change the temperature once you have started the appliance.

1. Press the temperature.

2. Swipe left or right until the required temperature appears in the middle.

- ✓ The temperature will now be changed.

### 7.6 Changing the type of heating

If you switch to a different heating function, the appliance will reset all the settings.

1. Press  to pause operation.

2. Press the heating function.

3. Swipe left or right until the required heating function appears in the middle.

4. Set the temperature and start the appliance.

### 7.7 Pausing operation

1. Press .

2. Press  again to resume operation.

### 7.8 Cancelling operation

**Note:** Some functions, e.g. cleaning functions, cannot be cancelled.

- ▶ Press and hold the ▷|| button until the function that is currently in progress is cancelled.
- ✓ Operation will stop and all the settings will be reset.
- ✓ The cooling fan will continue to run until the cooking compartment has cooled down.

## 7.9 Viewing the current temperature

You can view the current temperature while the appliance is heating up.

- ▶ Press .
- ✓ The temperature will be displayed for a few seconds.

## 7.10 Displaying information

**Requirement:** The  button must be lit.



- ▶ Press .
- ✓ The information will be displayed for a few seconds.

# 8 Time-setting options

Your appliance has different time-setting options, with which you can control its operation.

## 8.1 Overview of the time-setting options





When you are setting a time, the time values will increase by greater increments as you scroll through the higher values. The cooking time, for example, can be set in 1-minute increments up to 1 hour, and then in 5-minute increments thereafter.

Time-setting option	Use
Timer 	When you set a time on the timer, the timer will run independently of the appliance and will not intervene in its operation. The timer does not affect the appliance.
Cooking time 	Once the cooking time has elapsed, the appliance automatically stops heating.
Ready at 	Along with the cooking time (duration), you can set the time at which you want cooking to end. The appliance will start up automatically so that it finishes cooking at the required time.

## 8.2 Timer

You can set the timer regardless of whether the appliance is on or off.

### Setting the timer

1. Press .
2. Once the appliance is switched on, press "Timer" .
3. Swipe left or right to select the required timer duration.
4. Press  to start the timer.
- ✓  will appear on the display. The timer duration will then count down.
- ✓ Once the timer duration has elapsed, an audible signal will sound.
5. Press any button to end the audible signal.

### Changing the timer

1. Press .

2. Swipe left or right to change the timer duration.
- ✓ The setting will then be applied.

### Cancelling the timer

1. Press .
2. Swipe right to set the timer duration to "00:00".
- ✓ This cancels the current timer duration.

## 8.3 Cooking time

Once the set cooking time has elapsed, the appliance switches off automatically. You can only use the cooking time in conjunction with a heating function.

### Setting the cooking time

1. Set a heating function and a temperature.
2. Press .
3. Swipe left or right to select the required cooking time.
4. Once the cooking time has been set, press ▷|| to start.
- ✓ The cooking time will appear on the display. The cooking time will count down.
- ✓ Once the cooking time has elapsed, an audible signal will sound.
5. Press any button to end the audible signal.

### Changing the cooking time

1. Press .
2. Swipe left or right to change the cooking time.
- ✓ The setting will then be applied.

### Cancelling the cooking time

1. Press .
2. Swipe right to set the cooking time to "00:00".
- ✓ This cancels the current cooking time.
3. To continue without setting a cooking time, press ▷||.

## 8.4 Delayed start/"Ready at" time

With this function, the appliance automatically switches itself on, and then switches itself off at the preselected end time. To enable it to do this, you set the cooking



time (duration) and specify when you want your food to be ready. You can only use the delayed start function in conjunction with a heating function.

## Setting the "Ready at" time for delayed starts

### Notes

- Do not leave food that spoils easily in the cooking compartment for too long.
  - You cannot use the delayed start function with every heating function.
1. Place the food into the cooking compartment and close the appliance door.
  2. Set a heating function and a temperature.
  3. Press  $\odot$ .
  4. Swipe left or right to select the required cooking time.
  5. Press "Ready at"  $\rightarrow$ .
- ✓ The time at which your food will be ready will appear on the display.

6. Swipe left to select the required end time.
7. Press  $\gg$  to confirm the delayed start.
  - ✓ The appliance will start at the appropriate time.
  - ✓ Once the cooking time has elapsed, an audible signal will sound.
8. Press any button to end the audible signal.

## Changing the "Ready at" time for delayed starts

1. Press  $\odot$ .
2. Press "Ready at"  $\rightarrow$ .
3. Swipe left or right to change the end time.
  - ✓ The setting will then be applied.

## Cancelling the "Ready at" time for delayed starts

1. Press  $\odot$ .
2. Swipe right to reset the end time.
  - ✓ The end time corresponds to the current time plus the set cooking time.
  - ✓ The appliance will start heating using the set cooking time.

# 9 Microwave

You can use the microwave to cook, heat up, bake or defrost food very quickly. The microwave can be used on its own or in combination with a type of heating.

## 9.1 Cookware and accessories with microwave

To heat food evenly and avoid damaging your appliance, it is important to only use the right cookware and accessories.

Follow the cookware manufacturer's instructions. Unless otherwise specified, place the cookware and accessory on level 1.

### Microwave-safe

Cookware and accessories	Information
Cookware made from heat-resistant, microwave-safe material:	These materials allow microwaves to pass through and are not damaged.
<ul style="list-style-type: none"> <li>■ Glass</li> <li>■ Glass ceramic</li> <li>■ Porcelain</li> <li>■ Temperature-resistant plastic</li> <li>■ Fully glazed ceramic without cracks</li> </ul>	

Cookware and accessories	Information
Serving dishes	You do not need to transfer your food. <b>Note:</b> Only use cookware with decorative gold or silver trim if the manufacturer guarantees its suitability for microwave use.
Supplied wire rack	Only the wire rack that is supplied is suitable for operation solely using the microwave. <b>Note:</b> Baking trays, e.g. the universal pan or the baking tray, may create sparks and are not suitable.

### Not microwave-safe

**Note:** Observe the specifications for preventing material damage.

→ "Microwave", Page 7

Cookware and accessories	Information
Metal cookware and bakeware	Microwaves cannot pass through metal. The food is barely heated or not heated at all. <b>Note:</b> Metal may create sparks in pure microwave operation.

### Cookware and accessories with MicroCombi

By combining the microwave and a type of heating, metal cookware and accessories are also possible.

Cookware and accessories	Information
Metal cookware and bakeware	Metal can be used with MicroCombi. <b>Note:</b> Metal must be kept at least 2 cm from the cooking compartment walls and the inside of the door.
Accessories supplied: <ul style="list-style-type: none"> <li>■ Wire rack</li> <li>■ Universal pan</li> </ul>	The supplied accessory is suitable for MicroCombi. No sparks are created.

### Testing cookware for microwave suitability

If you are unsure whether your cookware is suitable for use in the microwave, carry out a cookware test.

#### ATTENTION!

Operating the appliance without food in the cooking compartment may lead to overloading.

- ▶ Do not switch on the microwave unless there is food inside. The only exception to this rule is when performing a short cookware test.

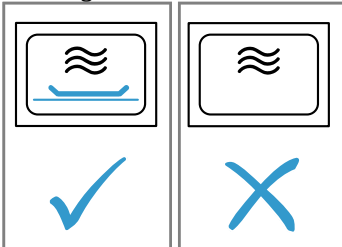

#### ⚠ WARNING – Risk of burns!

The accessible parts of the appliance become hot during operation.

- ▶ Never touch these hot parts.
- ▶ Keep children at a safe distance.

1. Place the empty cookware in the cooking compartment.
2. Set the appliance to run for 30 seconds to 1 minute at maximum power.
3. Start the operation.
4. Check the cookware several times:
  - If the cookware remains cold or warm to the touch, it is suitable for microwave use.
  - If the cookware becomes hot or sparks are created, stop the cookware test. The cookware is not microwave-safe.

## 9.2 Microwave

You can use the microwave to cook, heat up or defrost food quickly.

### Configuring the microwave settings

#### Notes

- Note the correct way to operate the microwave:
  - → "Safety", Page 2
  - → "Preventing material damage", Page 7
  - → "Microwave power settings", Page 11
  - → "Cookware and accessories with microwave", Page 15

- To prevent condensation, when the microwave power setting is 600 watts (max), the appliance automatically switches on a heating element. The cooking compartment and the accessories become hot. The cooking result is not affected by this. You can switch off this drying function in the basic settings.  
→ "Basic settings", Page 23

#### ⚠ WARNING – Risk of burns!

At the highest settings in microwave only mode, the drying function will automatically switch on an additional heating element to heat the cooking compartment.

- ▶ Never touch the inside surfaces of the cooking compartment or the heating elements while they are hot.
- ▶ Keep children at a safe distance.

1. Use to switch the appliance on.
2. Press .
3. Swipe left or right to configure the settings for the "microwave" .
4. Press the bottom row to select the microwave power setting.
  - ✓ A microwave power setting and a cooking time appear.
5. To select a microwave power setting, press the microwave power setting.
6. Press the bottom row to select the cooking time.
7. Swipe left or right to select a cooking time.
8. Use to start the microwave.
  - ✓ The microwave starts and the cooking time counts down. The heat-up bar pulses.
  - ✓ Once the cooking time has elapsed, an audible signal sounds and the appliance stops heating.
9. Press any button to end the signal tone.
  - If necessary, set the microwave power setting and cooking time again.
  - When the food is ready, use to switch the appliance off.
10. If you have switched off the drying function for the microwave in the basic settings, dry the cooking compartment.  
→ "Drying the cooking compartment with the 'Dry' function", Page 17

**Note:** If you open the appliance door during operation, the operation stops. When you close the appliance door, you must press to continue the operation. If you have changed the basic setting for this, make sure that the microwave does not resume operation without food inside.

→ "Basic settings", Page 23

### Changing the microwave power setting

If you change the microwave power setting, the cooking time is reset.

1. Press to pause operation.
2. Press the required microwave power setting.
3. Press the bottom row to select the cooking time.
4. Swipe left or right to select a cooking time.
5. Use to start the microwave.

### Changing the cooking time

1. Press .
2. Swipe left or right to change the cooking time.
  - ✓ The setting is applied.

## Drying the cooking compartment with the "Dry" function

The "Dry" function heats up the cooking compartment so that the moisture in the cooking compartment evaporates. You will then need to open the appliance door to allow the steam to escape.

### **⚠ WARNING – Risk of burns!**

The appliance becomes hot during operation.





- ▶ Allow the appliance to cool down before cleaning.

### **ATTENTION!**

If there is water on the cooking compartment floor when operating the appliance at temperatures above 120 °C, this will damage the enamel.

- ▶ Do not use the appliance if there is water on the cooking compartment floor.
- ▶ Wipe away any water on the cooking compartment floor before operation.





**Requirement:** The cooking compartment must have cooled down.

1. Remove any food remnants from the cooking compartment.
2. Dry the cooking compartment with a sponge.
3. Press  to switch the appliance on.
4. Press .
5. Swipe left or right to select "Dry" .
6. Press the bottom row.
  - ✓ The duration will appear on the display. The duration cannot be changed.
7. Press the bottom row.
8. Press  to start drying the appliance.
  - ✓ Once the duration has elapsed, an audible signal will sound and the appliance will stop heating.
9. Press  to switch the appliance off.
10. Remove limescale marks with a cloth soaked in vinegar, then wipe with clean water and dry with a soft cloth.
11. Leave the appliance door open for 1-2 minutes so that the cooking compartment dries completely.

## 9.3 Microwave combination

To reduce the cooking time, you can use certain types of heating in combination with the microwave.

Possible types of heating include:

- Hot air 
- Top/bottom heating 
- Circo-roasting 
- Grill, large area 
- Grill, small area 

Possible microwave power settings include:







- 90 watts
- 180 watts
- 360 watts

### Setting the microwave combination

#### **Note:**

Note the correct way to operate the microwave:

- → "Safety", Page 2
- → "Preventing material damage", Page 7
- → "Microwave power settings", Page 11
- → "Cookware and accessories with microwave", Page 15

1. Use  to switch the appliance on.
2. Press .
3. Swipe left or right to set the "microwave combination" .
4. Press "Next".
5. To select the type of heating, press "Type of heating".
6. Swipe left or right to select a type of heating.
7. To select a temperature, press "Temperature".
8. Swipe left or right to select a temperature.
9. To select the microwave power setting, press "Microwave power setting".
10. Swipe left or right to select a microwave power setting.
11. To select the cooking time, press "Cooking time".
12. Swipe left or right to select a cooking time.
13. Press  to save the settings.
14. Use  to start the microwave combination.
  - ✓ The microwave combination starts and the cooking time counts down. The heat-up bar lights up.
  - ✓ Once the cooking time has elapsed, an audible signal sounds and the appliance stops heating.
15. Press any button to end the signal tone.
  - If necessary, set another microwave combination.
  - When the food is ready, use  to switch the appliance off.

**Note:** If you open the appliance door during operation, the operation stops. When you close the appliance door, you must press  to continue the operation. If you have changed the basic setting for this, make sure that the microwave does not resume operation without food inside.

→ "Basic settings", Page 23

### Changing the temperature

You can also change the temperature while operation is in progress with the microwave combination.



1. Press the temperature.
2. Swipe left or right until the changed temperature appears in the middle.
  - ✓ The temperature is changed.

### Changing the cooking time

1. Press .
2. Swipe left or right to change the cooking time.
  - ✓ The setting is applied.

### Changing the microwave combination

If you change the combination of the type of heating and the microwave power setting, all other settings are reset.

1. Press  to pause operation.
2. Press "Type of heating" or "Microwave power setting".
3. Swipe left or right to select the type of heating or the microwave power setting.
4. To select a temperature, press "Temperature".
5. Swipe left or right to select a temperature.
6. To select the cooking time, press "Cooking time".
7. Swipe left or right to select a cooking time.
8. Press  to save the settings.
9. Use  to start the microwave combination.



## 10 Microwave programmes

The microwave programmes help you to use your appliance to prepare different dishes by selecting the optimum settings automatically. This significantly reduces the cooking time.

### 10.1 Cookware

The cooking result depends on the composition of the meat and the size of cookware.

You should therefore use heat-resistant cookware that is suitable for temperatures up to 300 °C. Glass or glass ceramic cookware is best. The joint should cover approx. two thirds of the cookware base.

Cookware made from the following material is not suitable:

- Bright, shiny aluminium
- Unglazed clay
- Plastic or plastic handles

**Note:** For some dishes, the appliance switches on the microwave. A notification appears in the display stating that you should use cookware that is suitable for microwave use.

→ "Cookware and accessories with microwave", Page 15

### 10.2 Meat probe

You can use the meat probe for several dishes. If the meat probe is plugged in, only the dishes that are possible with the meat probe are available for selection. For each dish, you receive recommended settings for type of heating, temperature and core temperature. You can adjust the temperature and the core temperature.

→ "Meat probe", Page 19

### 10.3 Overview of the microwave programmes

You can select the following microwave programmes:





- Defrost poultry portions
- Defrost meat
- Defrost fish fillet
- Vegetables, fresh
- Vegetables, frozen
- Boiled potatoes
- Long-grain rice

- Steam fish fillet
- Pizza, frozen, with thin base, x 1
- Lasagne, frozen
- Chicken, unstuffed
- Chicken portions
- Meat loaf made from fresh mince
- Baked potatoes, whole

### 10.4 Setting the microwave programme

**Note:** The cooking result depends on the quality and composition of the food. Use fresh and, ideally, chilled food.

#### Requirements

- Observe the information for the microwave.
    - "Microwave", Page 15
  - Weigh the food. The weight of the food is necessary in order to set the microwave programme.
1. Use  to switch the appliance on.
  2. Press .
  3. Swipe left or right to select "Microwave programmes" .
  4. Press the bottom row.
  5. Press the required category.
  6. Swipe left or right to select the required microwave programme.
  7. Press the microwave programme.
  8. Swipe left or right to adjust the weight.
  9. Press the bottom row.
    - ✓ The recommended shelf position and cookware are displayed.
  10. Use  to start the microwave programme.
    - ✓ Once the cooking time has elapsed, an audible signal sounds and the appliance stops heating.
  11. **Note:** With some microwave programmes, you can continue to cook the food.
    - "Extending the cooking time", Page 18
    - If you are happy with the cooking result, press "End".

### 10.5 Extending the cooking time

1. Press "Extend cooking time".
2. Swipe left or right to change the settings.
3. Press  to start the appliance again for the extra cooking time.

# 11 Meat probe

Cook with precision by inserting the meat probe into the food and setting a core temperature on the appliance. Once the set core temperature has been reached in the food, the appliance automatically stops heating.

## 11.1 Suitable types of heating with the meat probe

Only certain types of heating are suitable for use with the meat probe.

Once you have placed the roasting sensor in the cooking compartment, the following types of heating are available for you to select.

- CircoTherm hot air 
- Top/bottom heating 
- Circo-roasting 
- CircoTherm Intensive 
- Slow cooking 
- Top/bottom heating eco 
- CircoTherm eco 

## 11.2 Inserting the meat thermometer

Use the meat probe supplied or order a suitable meat probe from our after-sales service.

### **WARNING – Risk of electric shock!**

Using the wrong meat probe could damage the insulation.

- ▶ Only use the meat probe for this specific appliance.

### **ATTENTION!**

Otherwise the meat probe may be damaged.

- ▶ Do not trap the cable of the meat probe.
- ▶ Do not use cookware with a lid.
- ▶ To prevent the meat probe from being damaged by excessive heat, there must be a gap of a few centimetres between the grill element and the meat probe. The meat may expand during the cooking process.

If, during operation with the microwave, the tip of the meat probe is not fully inside the food, sparks will be created.

- ▶ Insert the meat probe fully into the food.

1. Insert the meat probe into the food. The meat probe has three measuring points. Ensure that at least the middle measuring point is inserted in the food.

Thin pieces of meat	Insert the meat probe into the thickest part of the meat from the side.
---------------------	---

Thick pieces of meat

Insert the meat probe diagonally into the meat from above, pushing it in as far as possible.

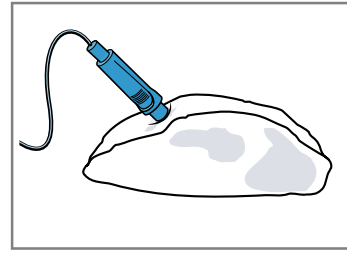

Poultry

Insert the meat probe into the thickest part of the breast, pushing it in as far as possible. The meat probe can be inserted horizontally or vertically depending on the size and shape of the poultry.

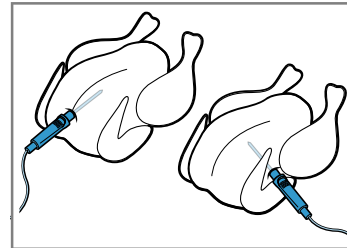

Turn the poultry and place it on the wire rack breast-side down.

Fish

When cooking whole fish, insert the meat probe behind the fish's head in the direction of the spine, pushing it in as far as possible.

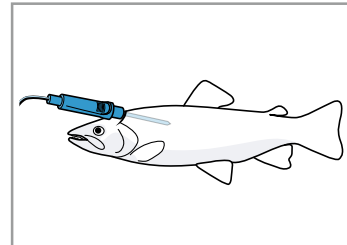

Place the fish on the wire rack in the swimming position without turning it, e.g. using half a potato as a support.

2. Place the food with the meat probe into the cooking compartment.
3. Plug the meat probe into the socket on the left-hand side of the cooking compartment.

### **Notes**

- If you remove the meat probe while the food is cooking, all the settings will be reset.
- Do not remove the meat probe when turning the food. Once you have turned the food, check that the meat probe is correctly positioned in the food.

## 11.3 Core temperatures of different foods

Here you can find the suggested core temperatures of various different foods.

These suggestions depend on the quality and the size/shape of the food. Do not use frozen food.







<b>Poultry</b>	<b>Core temperature in °C</b>
Chicken	80 - 85
Chicken breast	75 - 80
Duck	80 - 85
Duck breast, medium rare	55 - 60
Turkey	80 - 85
Turkey breast	80 - 85
Goose	80 - 90
<b>Pork</b>	<b>Core temperature in °C</b>
Shoulder of pork	85 - 90
Fillet of pork, medium rare	62 - 70
Pork loin, well done	72 - 80
<b>Beef</b>	<b>Core temperature in °C</b>
Tenderloin or sirloin, rare	45 - 52
Tenderloin or sirloin, medium rare	55 - 62
Tenderloin or sirloin, well done	65 - 75
<b>Veal</b>	<b>Core temperature in °C</b>
Joint of veal or hock, lean	75 - 80
Joint of veal, shoulder	75 - 80
Veal knuckle	85 - 90
<b>Lamb</b>	<b>Core temperature in °C</b>
Leg of lamb, medium rare	60 - 65
Leg of lamb, well done	70 - 80
Saddle of lamb, medium rare	55 - 60
<b>Fish</b>	<b>Core temperature in °C</b>
Whole fish	65 - 70
Fish fillet	60 - 65
<b>Other</b>	<b>Core temperature in °C</b>
Meat loaf, all kinds of meat	80 - 90
Heating food, reheating	65 - 75

## 11.4 Setting the oven temperature and core temperature

The meat probe measures the temperature inside the food between 30 °C and 99 °C.

### Requirements



- The food with the meat probe is in the cooking compartment.
- The meat probe is inserted in the cooking compartment.

1. Press  to switch the appliance on.
2. Select a suitable heating function.
3. Press "Cooking compartment temperature" on the left in the bottom row.
4. Swipe left or right to select the required cooking compartment temperature.  
Set the cooking compartment temperature at least 10 °C higher than the core temperature.  
Do not set the cooking compartment temperature to higher than 250 °C.
5. Press  to save the cooking compartment temperature.
6. Press "Core temperature"  on the right in the bottom row.
7. Swipe left or right to select the required core temperature.
8. Press  to start cooking using the meat probe.
- ✓ Once the required core temperature has been reached, an audible signal will sound and the appliance will stop heating.
9. Press  to switch the appliance off.
10.  **WARNING – Risk of burns!**  
The cooking compartment, accessories and meat probe become very hot.
  - ▶ Always use oven gloves to remove hot accessories and the meat probe from the cooking compartment.
 Pull the meat probe out of the socket in the cooking compartment.

## 11.5 Changing the cooking compartment temperature or core temperature

1. Press the cooking compartment temperature or core temperature twice.
2. Swipe left or right to change the temperature.
3. Press  to save your setting.

## 11.6 Cancelling operation with the meat probe

- ▶  **WARNING – Risk of burns!**  
The cooking compartment, accessories and meat probe become very hot.
  - ▶ Always use oven gloves to remove hot accessories and the meat probe from the cooking compartment.
 To continue cooking without the meat probe, pull the meat probe out of the socket in the cooking compartment and out of the food, and then press  to resume operation.
  - To cancel operation, press  to switch the appliance off.

## 12 Baking and roasting assistant

The baking and roasting assistant helps you to use your appliance to cook various dishes by suggesting the optimal settings.

The baking and roasting assistant helps you to make classic cakes, bread and roasts. The appliance selects the optimal heating function for you. The default temperature and cooking time can be changed according to your requirements.

### 12.1 Overview of available foods





You can choose from the following foods:

- Sponge in a springform tin/loaf tin
- Sponge (6 eggs)
- Swiss roll
- Yeast dough tray bakes with dry topping
- Plaited ring/loaf
- Small baked puff-pastry items
- Muffins, on one level
- White bread in a loaf tin
- Part-baked bread rolls/baguettes
- Pizza, frozen, thin base, x 1
- Chips, frozen, on one level
- Potato gratin, made from raw potatoes
- Baked potatoes
- Lasagne, fresh
- Joint of pork, marbled, without rind
- Meat loaf (1 kg)
- Sirloin, medium, 1.5 kg
- Beef pot roast
- Leg of lamb, boned
- Chicken, whole
- Chicken legs
- Goose, whole (3-4 kg)

### 12.2 Configuring the baking and roasting assistant

**Note:** Use fresh and, ideally, chilled food. Use frozen food straight from the freezer.

**Requirement:** The cooking compartment must have cooled down.

1. Press  to switch the appliance on.
2. Press .
3. Swipe left or right to select "Baking and roasting assistant" .
4. Press the bottom row.
5. Tap the required category.
6. Swipe left or right to select the required food.
7. Press the required food.
  - ✓ The recommended settings will appear on the display.
8. **Note:** Additional information cannot be selected for all foods.
  - Swipe left to view the additional information about the food.
  - ✓ Additional information will appear, for example regarding which shelf position, accessories or cookware you should use or when you should turn or stir your food or add liquid.
9. To adjust the recommended settings, press "Adjust".
  - Press the setting.
  - Swipe left or right to adjust the setting.
10. Press  to start the baking and roasting assistant.
  - ✓ Some food needs to be turned or stirred. An audible signal will sound and a notification will appear on the display to let you know when it is time to turn or stir your food.
  - ✓ Once the cooking time has elapsed, an audible signal will sound and the appliance will stop heating.
11. **Note:** Some programs allow you to extend the cooking time.
  - "Extending the cooking time", Page 21
  - If you are happy with the cooking result, press "End".

### 12.3 Extending the cooking time



1. Press "Extend cooking time".
2. Swipe left or right to change the settings.
3. Press  to start the appliance again for the extra cooking time.

## 13 Childproof lock

You can secure your appliance to prevent children from accidentally switching it on or changing the settings.



### 13.1 Locks

Your appliance has two different locks:



Lock	Activate/deactivate
Automatic childproof lock	Via the MyProfile menu 
One-time childproof lock	Using the  button

### 13.2 Activating the automatic childproof lock



The automatic childproof lock disables the control panel to prevent children from accidentally switching on the appliance. To switch on the appliance, interrupt the automatic childproof lock. Once the appliance has finished cooking, it automatically disables the control panel.

**Note:** When you activate the automatic childproof lock, the appliance will immediately disable the control panel. The  and  buttons will not be disabled.



**Requirement:** The appliance must be switched on.

1. Press .
2. Swipe left or right to select "MyProfile" .





## en Rapid heating

3. Press the bottom row.
  4. Swipe left or right to select the "Automatic childproof lock".
  5. Press the bottom row.
  6. Swipe right to set the lock to "Activated".
  7. Press .
  8. Press "Save" to save your settings.
- ✓ When you switch off the appliance,  will appear on the display.

### 13.3 Interrupting the automatic childproof lock

1. Press and hold the  button until "Childproof lock deactivated" appears on the display.
2. Press  to switch the appliance on and then start it up.



### 13.4 Deactivating the automatic childproof lock

1. Press and hold the  button until "Childproof lock deactivated" appears on the display.
2. Press  to switch the appliance on.
3. Press .
4. Swipe left or right to select "MyProfile" .
5. Press the bottom row.

6. Press the top row.
7. Swipe left or right to select the "Automatic childproof lock".
8. Press the bottom row.
9. Swipe left to set the lock to "Deactivated".
10. Press .
11. Press "Save" to save your settings.

### 13.5 Activating the one-time childproof lock

The one-time childproof lock disables the control panel to prevent children from accidentally switching on the appliance. To switch on the appliance, deactivate the one-time childproof lock. After you have switched off the appliance, the control panel will no longer be disabled.

**Note:** When you activate the automatic childproof lock, the appliance will immediately disable the control panel. The  and  buttons will not be disabled.

- ▶ Press and hold the  button until "Childproof lock activated" appears on the display.

### 13.6 Deactivating the one-time childproof lock

- ▶ Press and hold the  button until "Childproof lock deactivated" appears on the display.





---



## 14 Rapid heating

You can use rapid heating to reduce the heat-up time. You can activate rapid heating for the following types of heating:

- Hot air 
- Top/bottom heating 

### 14.1 Activating the "Rapid heat-up" function

1. Set Hot air  or Top/bottom heating  and a temperature of at least 100 °C.
  2. Press  to start.
- ✓ The  button will be lit.
3. Use the  button to activate the "Rapid heat-up" function.

- ✓  will appear on the display.
  - ✓ Once the set temperature has been reached, the "Rapid heat-up" function will switch itself off automatically and an audible signal will sound.  will go out on the display.
4. Place the food in the cooking compartment.

### 14.2 Deactivating the "Rapid heat-up" function

- ▶ Use the  button to deactivate the "Rapid heat-up" function early.

---

## 15 Sabbath mode





You can set a cooking time of up to 74 hours using Sabbath mode. You can use top/bottom heating to keep food warm between 85 °C and 140 °C during this time without having to switch the appliance on or off.

### 15.1 Starting Sabbath mode

#### Notes

- If you open the appliance door during operation, the appliance stops heating. When you close the appliance door, the appliance continues to heat again.
- Once you have started the operation, you cannot change any settings or pause operation.

**Requirement:** Sabbath mode must be activated in "Favourites" in the basic settings.

1. Press  to switch the appliance on.
  2. Swipe left or right to select "Sabbath mode".
  3. Press "Temperature".
  4. Swipe left or right to select the temperature.
  5. Press  to save your setting.
  6. Press "Cooking time".
  7. Swipe left or right to select the cooking time.
  8. Press  to save your setting.
  9. Press  to start Sabbath mode.
- ✓ The cooking time appears on the display. The cooking time counts down.

10. Once the cooking time has elapsed, an audible signal sounds. A note appears on the display confirming that the operation has finished. The appliance stops heating up and responds again as usual outside of Sabbath mode.
- Press  to switch the appliance off.

The appliance automatically switches off after approx. 10 to 20 minutes.

## 15.2 Cancelling Sabbath mode

- ▶ Press  to cancel Sabbath mode.

# 16 Basic settings

You can configure the appliance to meet your needs.





## 16.1 Overview of the basic settings

Here you can find an overview of the basic settings and factory settings. The basic settings depend on the features of your appliance.

Basic setting	Selection
Language	See selection on the appliance
Time	00:00 - 23:59
Date	Day, month and year
Favourites → "Changing your favourites", Page 23	Set the heating functions that you want to appear in the heating functions menu
Audible signal	<ul style="list-style-type: none"> <li>▪ Short duration</li> <li>▪ Medium duration</li> <li>▪ Long duration</li> </ul>
Volume	5 settings
Button tone	<ul style="list-style-type: none"> <li>▪ Off (except for )</li> <li>▪ On</li> </ul>
Display brightness	5 settings
Clock display	<ul style="list-style-type: none"> <li>▪ Off</li> <li>▪ Digital</li> <li>▪ Analogue</li> </ul>
Lighting	<ul style="list-style-type: none"> <li>▪ On during operation</li> <li>▪ Off during operation</li> </ul>
Auto resume	<ul style="list-style-type: none"> <li>▪ When you close the door</li> <li>▪ No auto resume</li> </ul>
Childproof lock	<ul style="list-style-type: none"> <li>▪ Button lock only</li> <li>▪ Door lock and button lock</li> </ul>
Automatic childproof lock	<ul style="list-style-type: none"> <li>▪ Deactivated</li> <li>▪ Activated</li> </ul>
Operation after switch-on	<ul style="list-style-type: none"> <li>▪ Main menu</li> <li>▪ Types of heating</li> <li>▪ Microwave</li> <li>▪ Microwave combination</li> <li>▪ Baking and roasting assistant</li> <li>▪ Microwave programs</li> </ul>
Night-time dimming	<ul style="list-style-type: none"> <li>▪ Switched off</li> <li>▪ On (display dimmed between 10 p.m. and 5.59 a.m.)</li> </ul>

Basic setting	Selection
Warning: Baking tray in MW	<ul style="list-style-type: none"> <li>▪ Indicators/symbols</li> <li>▪ Do not display</li> </ul>
Brand logo	<ul style="list-style-type: none"> <li>▪ Indicators/symbols</li> <li>▪ Do not display</li> </ul>
Dry microwave	<ul style="list-style-type: none"> <li>▪ On</li> <li>▪ Off</li> </ul>
Fan run-on time	<ul style="list-style-type: none"> <li>▪ Recommended</li> <li>▪ Minimum</li> </ul>
Factory settings	Restore

## 16.2 Changing MyProfile



1. Press  to switch the appliance on.
2. Press .
3. Swipe left or right to select "MyProfile" .
4. Press the bottom row.
5. Swipe left or right to select a setting.
6. Press the bottom row.
7. Swipe left or right to change the setting.
8. Press .
9. To save your settings, press "Save".
  - To discard your settings, press "Discard".



## 16.3 Changing your favourites

In Favourites, you can set the heating functions that you want to appear in the heating functions menu.

### Note:

Some heating functions cannot be deactivated:

- CircoTherm hot air 
- Circo-roasting 
- Full-surface grill 

1. Press  to switch the appliance on.
2. Press .
3. Swipe left or right to select "MyProfile" .
4. Press the bottom row.
5. Swipe left or right to select "Favourites".
6. Press the bottom row.
7. Swipe left or right to select a heating function.
8. Press the required setting.

Setting	Display in the heating functions menu?
Activated	Yes
Deactivated	No

9. Press .
10. To save your settings, press "Save".
  - To discard your settings, press "Discard".



# 17 Cleaning and servicing

To keep your appliance working efficiently for a long time, it is important to clean and maintain it carefully.

## 17.1 Cleaning products

In order to avoid damaging the various oven surfaces on the appliance, do not use unsuitable cleaning products.

**⚠ WARNING – Risk of electric shock!**

An ingress of moisture can cause an electric shock.

- ▶ Do not use steam- or high-pressure cleaners to clean the appliance.

**ATTENTION!**

Unsuitable cleaning products may damage the surfaces of the appliance.

- ▶ Do not use harsh or abrasive cleaning products.

- ▶ Do not use cleaning products with a high alcohol content.
- ▶ Do not use hard scouring pads or cleaning sponges.
- ▶ Do not use any special cleaners for cleaning the appliance while it is hot.

Using oven cleaner in a hot cooking compartment damages the enamel.

- ▶ Never use oven cleaner in the cooking compartment when it is still warm.
- ▶ Remove all food remnants from the cooking compartment and the appliance door before you next heat up the appliance.

New sponge cloths contain residues from production.

- ▶ Wash new sponge cloths thoroughly before use.

## Suitable cleaning agents

Only use cleaning agents that are suitable for the different surfaces on your appliance.

Follow the instructions on cleaning the appliance.  
→ "Cleaning the appliance", Page 25

### Appliance front

Surface	Suitable cleaning agents	Information
Stainless steel	<ul style="list-style-type: none"> <li>▪ Hot soapy water</li> <li>▪ Special stainless steel cleaning products suitable for hot surfaces</li> </ul>	To prevent corrosion, remove any limescale, grease, starch or albumin (e.g. egg white) stains on stainless steel fronts immediately. Apply a thin layer of the stainless steel cleaning product with a soft cloth.
Plastic or painted surfaces E.g. control panel	<ul style="list-style-type: none"> <li>▪ Hot soapy water</li> </ul>	Do not use glass cleaner or a glass scraper. To avoid permanent stains, remove any descaling agent that gets onto the surface immediately.

### Appliance door

Area	Suitable cleaning agents	Information
Door panels	<ul style="list-style-type: none"> <li>▪ Hot soapy water</li> </ul>	Do not use a glass scraper or a stainless steel wool. <b>Tip:</b> Remove the door panels in order to clean them thoroughly. → "Appliance door", Page 29
Door cover	<ul style="list-style-type: none"> <li>▪ Made of stainless steel: Stainless steel cleaner</li> <li>▪ Made of plastic: Hot soapy water</li> </ul>	Do not use glass cleaner or a glass scraper. Do not use stainless steel care products. <b>Tip:</b> Remove the door cover for thorough cleaning. → "Appliance door", Page 29
Stainless steel interior door frame	Stainless steel cleaner	Discolouration can be removed using stainless steel cleaner. Do not use stainless steel care products.
Door handle	<ul style="list-style-type: none"> <li>▪ Hot soapy water</li> </ul>	To avoid permanent stains, remove any descaling agent that gets onto the surface immediately.
Door seal	<ul style="list-style-type: none"> <li>▪ Hot soapy water</li> </ul>	Do not remove or scrub.

**Cooking compartment**

Area	Suitable cleaning agents	Information
Enamel surfaces	<ul style="list-style-type: none"> <li>▪ Hot soapy water</li> <li>▪ Vinegar water</li> <li>▪ Oven cleaner</li> </ul>	<p>Soak any heavily soiled areas and use a brush or steel wool. Leave the appliance door open to dry the cooking compartment after cleaning it.</p> <p><b>Notes</b></p> <ul style="list-style-type: none"> <li>▪ It is best to use the cleaning function. → "Self-cleaning function", Page 26</li> <li>▪ Enamel burns at very high temperatures, causing minor discoloration. The functionality of your appliance is not affected by this.</li> <li>▪ The edges of thin trays cannot be completely enamelled and may be rough. This does not impair corrosion protection.</li> <li>▪ Food residues will leave a white coating on the enamel surfaces. The coating does not pose a health risk. The functionality of your appliance is not affected by this. You can remove residues with lemon juice.</li> </ul>
Glass cover for the oven light	<ul style="list-style-type: none"> <li>▪ Hot soapy water</li> </ul>	Use oven cleaner to remove very heavy soiling.
Rails	<ul style="list-style-type: none"> <li>▪ Hot soapy water</li> </ul>	<p>Soak any heavily soiled areas and use a brush or steel wool.</p> <p><b>Note:</b> To clean thoroughly, detach the rails. → "Rails", Page 28</p>
Pull-out system	<ul style="list-style-type: none"> <li>▪ Hot soapy water</li> </ul>	<p>Use a brush to remove very heavy soiling. Clean the pull-out rails while they are pushed in so that you do not remove the lubricant. Do not clean in the dishwasher.</p> <p><b>Note:</b> To clean thoroughly, detach the pull-out system. → "Rails", Page 28</p>
Accessories	<ul style="list-style-type: none"> <li>▪ Hot soapy water</li> <li>▪ Oven cleaner</li> </ul>	Soak any heavily soiled areas and use a brush or steel wool. Enamelled accessories are dishwasher-safe.
Meat probe	<ul style="list-style-type: none"> <li>▪ Hot soapy water</li> </ul>	Use a brush to remove heavy soiling. Do not clean in the dishwasher.

**17.2 Cleaning the appliance**

In order to avoid damaging the appliance, you must clean your appliance only as specified, and with suitable cleaning products.

**⚠ WARNING – Risk of burns!**

The appliance and its parts that can be touched become hot during use.

- ▶ Caution should be exercised here in order to avoid touching heating elements.
- ▶ Young children under 8 years of age must be kept away from the appliance.

**⚠ WARNING – Risk of fire!**

Loose food remnants, fat and meat juices may catch fire.

- ▶ Before using the appliance, remove the worst of the food residues and remnants from the cooking compartment, heating elements and accessories.

**Requirement:** Read the information on cleaning products.

→ "Cleaning products", Page 24

1. Clean the appliance using hot soapy water and a dish cloth.
  - For some surfaces, you can use alternative cleaning agents.  
→ "Suitable cleaning agents", Page 24
2. Dry with a soft cloth.

# 18 Cleaning functions

You can use the cleaning functions to clean the appliance.

## 18.1 "Self-cleaning" function

The "Self-cleaning" function cleans the cooking compartment virtually automatically.

Use this cleaning function to clean the cooking compartment every 2 to 3 months. You can use the cleaning function more often, if required. The cleaning function requires approx. 2.5 - 4.7 kilowatt hours.

### Preparing the appliance for the cleaning function

To achieve a good cleaning result and prevent damage, prepare the appliance carefully.

#### **WARNING – Risk of fire!**

Combustible objects that are left in the cooking compartment may catch fire.

- ▶ Never store combustible objects in the cooking compartment.
- ▶ If smoke is emitted, the appliance must be switched off or the plug must be pulled out and the door must be held closed in order to stifle any flames.

Loose food remnants, fat and meat juices may catch fire when the cleaning function is in progress.

- ▶ Before you start the cleaning function, always remove coarse dirt from the cooking compartment.
- ▶ Never clean accessories at the same time.

The outside of the appliance gets very hot when the cleaning function is in progress.

- ▶ Never hang combustible objects, e.g. tea towels, on the door handle.
- ▶ Leave the front of the appliance clear.
- ▶ Keep children at a safe distance.

If the door seal is damaged, a large amount of heat is generated around the door.

- ▶ Do not scrub or remove the seal.
- ▶ Never operate the appliance if the seal is damaged or missing.

1. Remove accessories and cookware from the cooking compartment.  
You can also clean the shelf supports along with the pull-out rails.
2. Remove coarse dirt from the cooking compartment and from the rails.
3. Use a detergent solution and a soft cloth to clean the surfaces at the edges of the cooking compartment around the door seal.  
Do not remove or scrub the door seal.  
Use oven cleaner to remove stubborn dirt from the inner door pane.
4. Remove any objects from the cooking compartment. The cooking compartment must be empty except for the rails.

### Configuring the "Pyrolytic self-cleaning" function

#### **WARNING – Risk of harm to health!**

The cleaning function heats up the cooking compartment to a very high temperature so that food left over from roasting, grilling and baking will burn off. This process releases vapours, which can irritate mucous membranes.

- ▶ Keep the kitchen well ventilated while the cleaning function is running.
- ▶ Do not remain in the room for long periods.
- ▶ Keep children and pets away.

#### **WARNING – Risk of burns!**

The cooking compartment gets very hot when the cleaning function is in progress.



- ▶ Never open the appliance door.
- ▶ Allow the appliance to cool down.
- ▶ Keep children at a safe distance.

 The outside of the appliance gets very hot when the cleaning function is in progress.

- ▶ Never touch the appliance door.
- ▶ Allow the appliance to cool down.
- ▶ Keep children at a safe distance.

**Note:** The oven light will not be lit while the cleaning function is running.

**Requirement:** → "Preparing the appliance for the cleaning function", Page 26.



1. Press  to switch the appliance on.
2. Press .
3. Swipe left or right to set "Pyrolytic self-cleaning" .
4. Press the bottom row.
5. Swipe left or right to select the required cleaning setting.



Cleaning setting	Cleaning level	Duration in hours
1	Low	Approx. 1:15
2	Medium	Approx. 1:30
3	High	Approx. 2:00

Select a higher cleaning setting if the cooking compartment is particularly dirty or has not been cleaned for a while.

You cannot change the duration of the cleaning function.

Once the cleaning function is in progress, you cannot change the cleaning setting.

- ✓ The duration of the cleaning setting will appear on the display.
- 6. Press the bottom row.
- 7. **Note:** Keep the kitchen ventilated while the cleaning function is running.  
Press  to start the cleaning function.
- ✓ The cleaning function will start. The duration will count down on the display.
- ✓ For your safety, the appliance door locks the cooking compartment.  will appear on the display.
- ✓ Once the cleaning function has run through to the end, an audible signal will sound.

8. Press  to switch the appliance off.  
The appliance door will remain locked until the appliance has cooled down sufficiently and  has gone out.
9. After using the cleaning function, prepare the appliance so that it is ready to use again.  
→ "Preparing the appliance for use following the cleaning function", Page 27

### Preparing the appliance for use following the cleaning function

1. Allow the appliance to cool down.
2. Wipe off any ash that has been left behind in the cooking compartment, on the rails and around the appliance door with a damp cloth.
3. Slide the pull-out rails in and out several times.  
While the cleaning function is running, the rails may become discoloured. This discolouration does not compromise the functionality of the appliance.
4. Remove white residues with lemon juice.  
**Note:** White residues on the enamel surfaces may be caused by heavy soiling. These food residues are harmless. The deposits do not compromise the functionality of the appliance.

**Note:** While the cleaning function is running, the frame on the inside of the appliance door becomes discoloured. This discolouration does not compromise the functionality of the appliance. Use stainless steel cleaner to remove the discolouration.

## 18.2 "EasyClean" cleaning aid

You can use the "EasyClean" cleaning aid to clean light soiling from the cooking compartment between full cleans. The "EasyClean" cleaning aid soaks dirt by evaporating soapy water. It is then easier to remove the dirt.

### Setting the "EasyClean" cleaning aid





#### **WARNING – Risk of scalding!**

If there is water in the cooking compartment when it is hot, this may create hot steam.

- ▶ Never pour water into the cooking compartment when the cooking compartment is hot.

#### Requirements

- You can only start the cleaning aid once the cooking compartment is cold (room temperature) and the appliance door is closed.
- Do not open the appliance door while the appliance is in operation, as this will abort the cleaning aid.
- To remove particularly stubborn dirt, leave the soapy water to work for a while before starting the cleaning aid.
- To remove particularly stubborn dirt, rub washing-up liquid onto dirty areas on the smooth surfaces before starting the cleaning aid.

1. Remove any accessories from the cooking compartment.
2. **ATTENTION!**  
Distilled water in the cooking compartment leads to corrosion.  
▶ Do not use distilled water.  
Mix 0.4 litres water with a drop of washing-up liquid and pour into the centre of the cooking compartment floor.
3. Press  to switch the appliance on.
4. Press .
5. Select "EasyClean"   
To scroll through the various selection options, swipe to the left or right on the display.
6. Press the bottom row.
7. Press  to start the cleaning aid.  
✓ The cleaning aid will start. The duration will count down on the display.  
✓ Once the cleaning aid has run through to the end, an audible signal will sound.
8. Press any button to end the audible signal.
9. After using the cleaning aid, finish cleaning the cooking compartment.  
→ "Wiping down the cooking compartment", Page 27

### Wiping down the cooking compartment

#### **ATTENTION!**

The prolonged presence of moisture in the cooking compartment leads to corrosion.

- ▶ After using the cleaning aid, wipe the cooking compartment clean and allow it to dry fully.

**Requirement:** The cooking compartment must have cooled down.

1. Open the appliance door and remove the remaining water with an absorbent sponge cloth.
2. Clean the smooth surfaces in the cooking compartment with a dish cloth or a soft brush. Remove stubborn food remnants using a stainless steel scouring pad.
3. Remove limescale with a cloth soaked in vinegar. Then wipe with clean water and rub dry with a soft cloth (including under the door seal).
4. If there is any stubborn dirt that you are unable to remove, run the cleaning aid again once the cooking compartment has cooled down.
5. In order to dry the cooking compartment, leave the appliance door open in the detent position (approx. 30°) for approx. one hour.

## 19 Rails

To thoroughly clean the rails and the cooking compartment, or to replace the rails, you can remove the rails.

### 19.1 Detaching the rails

**⚠ WARNING – Risk of burns!**

The shelf supports get very hot

- ▶ Never touch the shelf supports when hot.
- ▶ Always allow the appliance to cool down.
- ▶ Keep children at a safe distance.

1. Pull out the pull-out forwards.
2. Lift the rail forwards slightly ① and detach it ②.
3. Swivel the entire rail outwards ③ and unhook it at the rear ④.

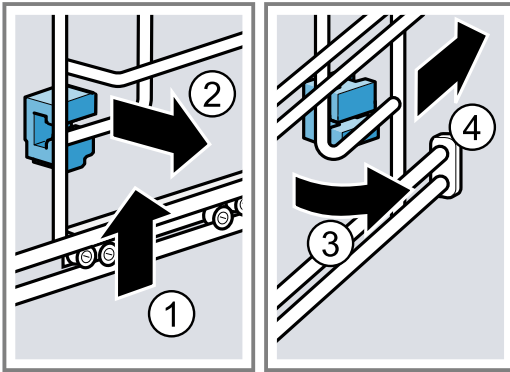

### 19.2 Fitting the retainers

The retainers may fall out when you detach the rails.

**Note:**

The retainers at the front differ from those at the rear.

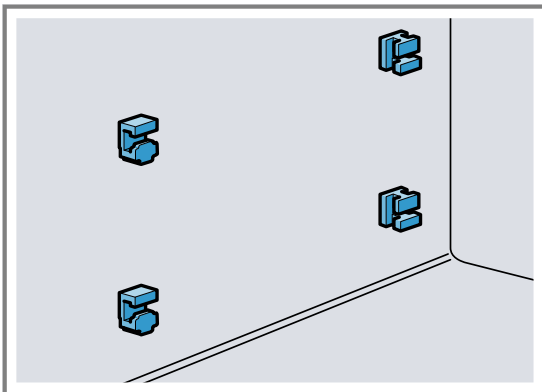

1. Hook the front retainers with the hook into the round hole at the top and set them at a slight angle ①.

2. Hook the front retainers in at the bottom and straighten them ②.

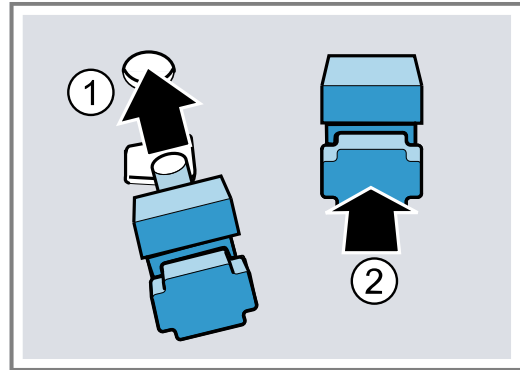

3. Hook the rear retainers with the hook into the top hole ① and push them into the bottom hole ②.

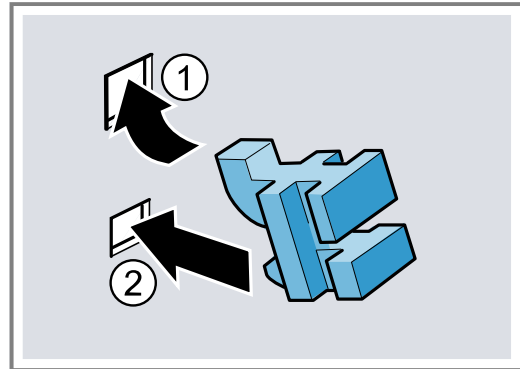

### 19.3 Attaching the rails

**Notes**

- When hanging the rails, ensure that the pull-out is at the bottom.
- The rails only fit on the right or left.
- For both pull-out rails, ensure that you can pull them forwards and out.

1. Set the rear rail at an angle, hooking it into the retainers at the top and bottom ①.
2. Pull the rail forwards ②.
3. Hook in the rail at the front ③ and press it down ④.

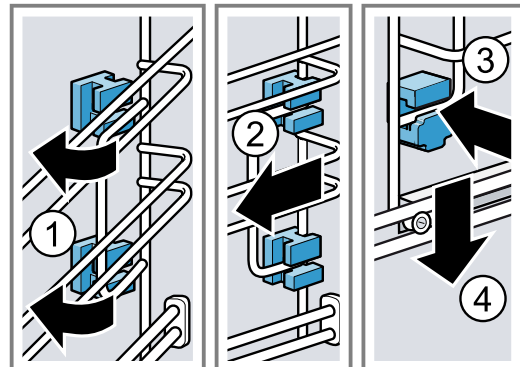

4. Push the pull-outs in completely.

## 20 Appliance door

To clean the appliance door thoroughly, you can disassemble the appliance door.

### 20.1 Removing the door cover

The stainless steel inlay in the door cover may discolour. Remove the door cover in order to clean it and the stainless steel inlay, or to remove the door panes.

1. Open the appliance door slightly.
2. Press down on the left- and right-hand sides of the door cover.
3. Remove the door cover and carefully close the appliance door.

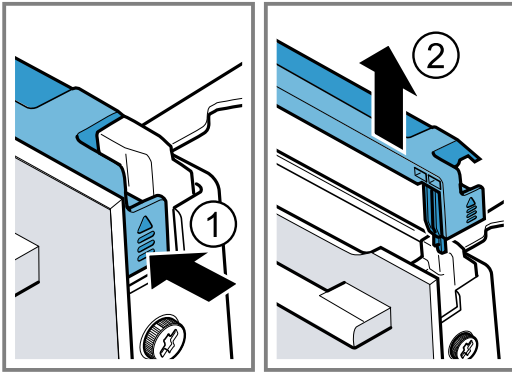

### 20.2 Removing the door panes

#### **⚠ WARNING – Risk of injury!**

Scratched glass in the appliance door may develop into a crack.

- ▶ Do not use any harsh or abrasive cleaners or sharp metal scrapers to clean the glass on the oven door, as they may scratch the surface.

The hinges on the appliance door move when the door is opened and closed, which could trap your fingers.

- ▶ Keep your hands away from the hinges.
- Components inside the appliance door may have sharp edges.
- ▶ Wear protective gloves.

**Requirement:** The door cover has been removed.

1. Undo and remove the screws on the left and right of the appliance door.
2. Place a folded-up tea towel in the appliance door.

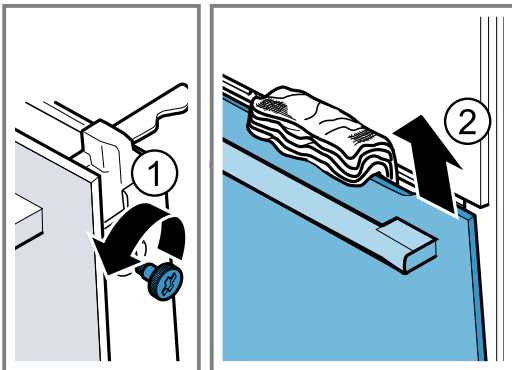

3. Close the appliance door.
4. Pull the front pane up and out.
5. Place the front pane down on a flat surface with the door handle facing down.

6. Press the intermediate pane against the appliance with one hand while pushing the left- and right-hand retainers **a** upwards. Do not detach the retainers **a**.

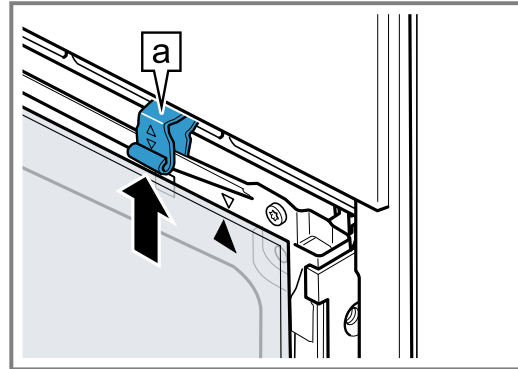

7. Remove the intermediate pane.
8. **⚠ WARNING – Risk of serious harm to health!**  
If the screws are undone, the safety of the appliance can no longer be guaranteed. Microwave energy may escape.
  - ▶ Never undo the screws.
 Never unscrew the four black screws on the frame.

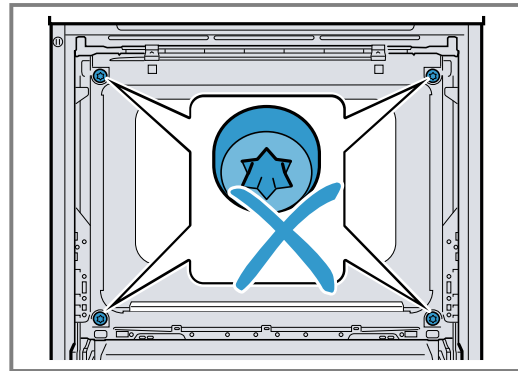

### 20.3 Fitting the door panes

#### **⚠ WARNING – Risk of injury!**

The hinges on the appliance door move when the door is opened and closed, which could trap your fingers.

- ▶ Keep your hands away from the hinges.
- Components inside the appliance door may have sharp edges.
- ▶ Wear protective gloves.

1. Turn the intermediate pane until the arrow **a** is in the top right.

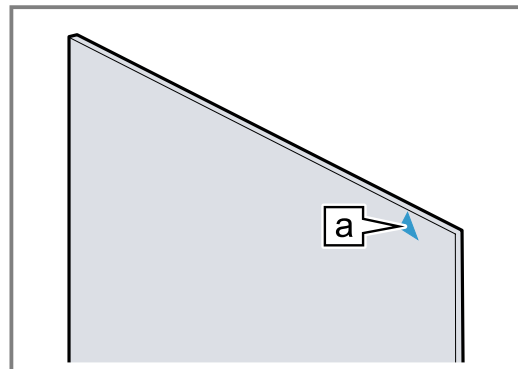



2. Insert the intermediate pane into the retainer **a** at the bottom ① and push it in firmly at the top.
3. Push the left- and right-hand retainer **a** downwards until the intermediate pane is clamped ②.

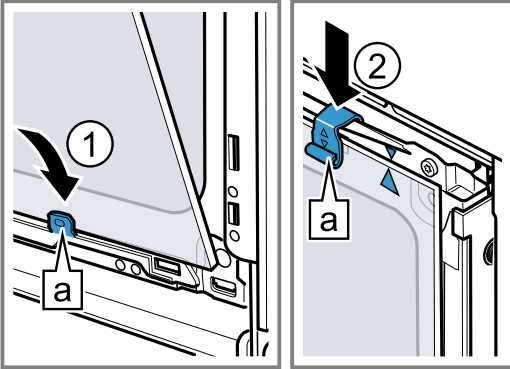

4. Attach the front pane downwards into the left- and right-hand retainers **a** ①.
5. Push the front pane to the appliance until the left- and right-hand hook **a** is opposite the support **b** ②.

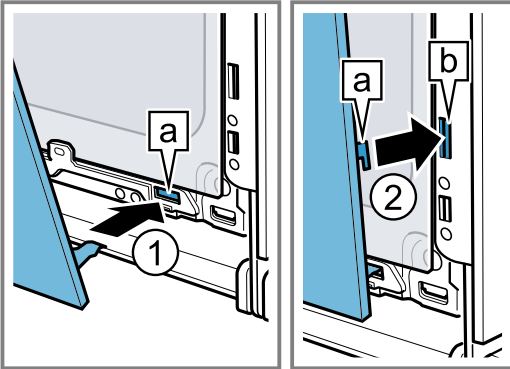

6. Push the front pane in at the bottom ① until you hear it click into place.
7. Open the appliance door slightly and remove the tea towel.
8. Screw both screws back in on the left and right of the appliance door.
9. Put the door cover in position and push down on it ② until you hear it click into place.

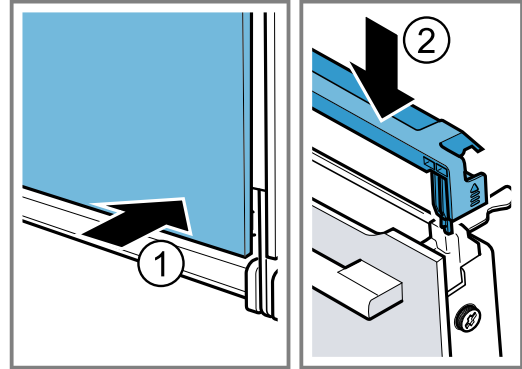

10. Close the appliance door.

**Note:** Do not use the cooking compartment again until the door panes have been correctly fitted.

## 21 Troubleshooting

You can rectify minor faults on your appliance yourself. Read the troubleshooting information before contacting after-sales service. This will avoid unnecessary costs.

### **⚠ WARNING – Risk of injury!**

Improper repairs are dangerous.

- ▶ Repairs to the appliance should only be carried out by trained specialist staff.
- ▶ If the appliance is defective, call Customer Service.







### **⚠ WARNING – Risk of electric shock!**

Incorrect repairs are dangerous.

- ▶ Repairs to the appliance should only be carried out by trained specialist staff.
- ▶ Only use genuine spare parts when repairing the appliance.
- ▶ If the power cord of this appliance is damaged, it must be replaced by the manufacturer, the manufacturer's Customer Service or a similarly qualified person in order to prevent any risk.

### 21.1 Malfunctions

Fault	Cause and troubleshooting
The appliance is not working.	The circuit breaker is faulty. <ul style="list-style-type: none"> <li>▶ Check the circuit breaker in the fuse box.</li> </ul>
	There has been a power cut. <ul style="list-style-type: none"> <li>▶ Check whether the lighting in your kitchen or other appliances are working.</li> </ul>
	Electronics fault <ol style="list-style-type: none"> <li>1. Briefly disconnect the appliance from the power supply by switching off the fuse.</li> <li>2. Reset the basic settings to the factory settings. → "Basic settings", Page 23</li> </ol>

Fault	Cause and troubleshooting
"Language English" appears on the display.	There has been a power cut. <ul style="list-style-type: none"> <li>▶ Configure the initial configuration settings. → "Initial use", Page 13</li> </ul>
The appliance cannot be switched on;  appears on the display.	Automatic childproof lock or childproof lock is activated <ul style="list-style-type: none"> <li>▶ Press and hold the  button until "Childproof lock deactivated" appears on the display.</li> </ul>
Appliance will not start or cuts out during operation.	Different causes are possible. <ul style="list-style-type: none"> <li>▶ Check any notifications that appear on the display. → "Displaying information", Page 14</li> </ul>
	Malfunction <ul style="list-style-type: none"> <li>▶ Call the after-sales service. → "Customer Service", Page 32</li> </ul>
The appliance is not heating;  appears on the display.	Demo mode is activated in the basic settings. <ol style="list-style-type: none"> <li>1. Briefly disconnect the appliance from the power supply by switching the circuit breaker in the fuse box off and then on again.</li> <li>2. Deactivate Demo mode within the next 3 minutes in the → "Basic settings", Page 23.</li> </ol>
	There has been a power cut. <ul style="list-style-type: none"> <li>▶ Open and close the appliance door once after a power failure.</li> <li>✓ The appliance will perform a self-test, after which it will be ready to use.</li> </ul>
Time not displayed when appliance switched off.	Basic setting has been changed. <ul style="list-style-type: none"> <li>▶ Change the basic setting for the clock display. → "Basic settings", Page 23</li> </ul>
Appliance door cannot be opened.	The cleaning function locks the appliance door;  is lit on the display. <ul style="list-style-type: none"> <li>▶ Allow the appliance to cool down until  goes out on the display. → "Self-cleaning function", Page 26</li> </ul>
	The childproof lock locks the appliance door. <ul style="list-style-type: none"> <li>▶ Use the  button to deactivate the childproof lock. → "Childproof lock", Page 21 You can switch off the lock in the basic settings. → "Basic settings", Page 23</li> </ul>
During simple microwave operation, the cooking compartment becomes hot.	The drying function is switched on.
The interior lighting does not work.	The LED light is defective. <p><b>Note:</b> Do not remove the glass cover.</p> <ul style="list-style-type: none"> <li>▶ Call the after-sales service. → "Customer Service", Page 32</li> </ul>
Maximum operating time reached.	To prevent the appliance from continuing to run when it is no longer needed, it automatically stops heating after a few hours if the settings are not changed during this time. A notification appears on the display. <p>The point at which the maximum operating time is reached is determined by the corresponding settings for an operating mode.</p> <ol style="list-style-type: none"> <li>1. Press any button to continue operation.</li> <li>2. If you do not need to use the appliance, press  to switch it off.</li> </ol> <p><b>Tip:</b> To prevent the appliance from switching off when you do not want it to, set a cooking time. → "Setting the cooking time", Page 14</p>
A message with "D" or "E" appears in the display, e.g. D0111 or E0111.	The electronics have detected a fault. <ol style="list-style-type: none"> <li>1. Switch the appliance off and on again.</li> <li>✓ If the fault was a one-off, the message disappears.</li> <li>2. If the message appears again, call the after-sales service. Please specify the exact error message when calling. → "Customer Service", Page 32</li> </ol>

Fault	Cause and troubleshooting
The cooking result is not satisfactory.	Settings were unsuitable. Setting values, e.g. temperature or cooking time, depend on the recipe, quantity and food. <ul style="list-style-type: none"> <li>▶ Next time, set lower or higher values.</li> </ul> <b>Tip:</b> A lot of information about the food preparation and corresponding setting values can be found on our website <a href="http://www.neff-international.com">www.neff-international.com</a> .

## 22 Disposal

### 22.1 Disposing of old appliance

Valuable raw materials can be reused by recycling.

1. Unplug the appliance from the mains.
2. Cut through the power cord.
3. Dispose of the appliance in an environmentally friendly manner.  
Information about current disposal methods are available from your specialist dealer or local authority.



This appliance is labelled in accordance with European Directive 2012/19/EU concerning used electrical and electronic appliances (waste electrical and electronic equipment - WEEE). The guideline determines the framework for the return and recycling of used appliances as applicable throughout the EU.

## 23 Customer Service

Detailed information on the warranty period and terms of warranty in your country is available from our after-sales service, your retailer or on our website.

If you contact Customer Service, you will require the product number (E-Nr.) and the production number (FD) of your appliance.

The contact details for Customer Service can be found in the enclosed Customer Service directory or on our website.

This product contains light sources from energy efficiency class G. These light sources are available as a spare part and should only be replaced by trained specialist staff.

### 23.1 Product number (E-Nr.) and production number (FD)

You can find the product number (E-Nr.) and the production number (FD) on the appliance's rating plate. You will see the rating plate with these numbers if you open the appliance door.

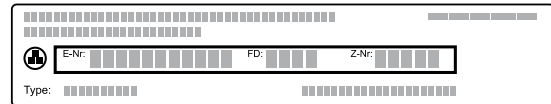

Make a note of your appliance's details and the Customer Service telephone number to find them again quickly.

## 24 How it works

Here, you can find the ideal settings for various types of food as well as the best accessories and cookware. We have perfectly tailored these recommendations to your appliance.

### 24.1 General cooking tips

Please take note of the following information when cooking all types of food.

- The temperature and cooking time depend on the amount of food and the recipe. Settings ranges are specified for this reason. Try using the lower values to start with.
- The setting values apply to food placed in the cooking compartment while the cooking compartment is still cold. Do not place accessories into the cooking compartment until it has finished preheating.
- Remove any accessories that are not being used from the cooking compartment.

### 24.2 Baking tips

- Dark-coloured metal baking tins are most suitable for baking cakes, bread and other baked goods.
- Use wide, shallow cookware for bakes and gratins. Food takes longer to cook in deep, narrow cookware and it browns more on top.
- If you are cooking bakes directly in the universal pan, place the universal pan into the cooking compartment at level 1.
- The setting values for bread dough apply to both dough placed on a baking tray and dough placed in a loaf tin.

**ATTENTION!**

When the cooking compartment is hot, any water inside it will create steam. The change in temperature may cause damage.

- ▶ Never pour water into the cooking compartment when it is still hot.
- ▶ Never place cookware containing water on the cooking compartment floor.

**Shelf positions**

If you bake on one level, use shelf position 1.

Baking on 2 levels	Shelf position
Universal pan	3
Baking tray	1
Baking tins on two wire racks	3
	1

Use the hot air heating function.

**Notes**

- Items that are placed in the appliance on baking trays or in baking tins/dishes at the same time will not necessarily be ready at the same time.
- If you opt for cooking in combination with the microwave mode, you can only cook on one level.

**24.3 Roasting, braising and grilling tips**

- The recommended settings are for fridge-temperature food and unstuffed, oven-ready poultry.
- Place the poultry onto the cookware breast-side or skin-side down.
- Turn roasting joints, grilled items or whole fish after approx.  $\frac{1}{2}$  to  $\frac{2}{3}$  of the specified time.
- The meat probe allows you to cook with absolute precision. Please take note of the important information on using it correctly. → Page 19

**Roasting on the wire rack**

Food roasted on the wire rack will become very crispy on all sides. You can roast large poultry, for example, or multiple individual pieces at the same time.

- Roast pieces of a similar weight and thickness. The grilled food will brown evenly and will remain succulent and juicy.
- Place the food to be roasted directly on the wire rack.
- To catch any liquids that drip down, place the universal pan into the cooking compartment one level below the wire rack.
- Add up to  $\frac{1}{2}$  litre of water to the universal pan, depending on the size and type of food that you want to roast.

You can make a sauce from the juices that are collected. This also means that less smoke is produced and the cooking compartment does not become as dirty.

**Roasting in cookware**

If you cover the cookware when you cook your food, this will keep the cooking compartment cleaner.

**General information about roasting in cookware**

- Use heat-resistant, ovenproof cookware.
- Place the cookware on the wire rack.

- Glass cookware is best.
- Follow the manufacturer's instructions for your roasting dishes.

**Roasting in uncovered cookware**

- Use a deep roasting dish.
- If you do not have any suitable cookware, you can use the universal pan.

**Roasting in covered cookware**

- Use a suitable lid that seals well.
- When roasting meat, there should be at least 3 cm between the food and the lid. The meat may expand.

**⚠ WARNING – Risk of scalding!**

Very hot steam may escape when the lid is opened after cooking. Steam may not be visible, depending on the temperature.

- ▶ Lift the lid in such a way that the hot steam can escape away from you.
- ▶ Keep children away from the appliance.

**Grilling**

Grill food if you want it to be crispy.

**ATTENTION!**

Acidic food may damage the grid

- ▶ Do not place acidic food, such as fruit or food with an acidic marinade directly on the pan support.
- When grilling several food items, choose pieces that are of a similar weight and thickness. The grilled food will brown evenly and will remain succulent and juicy.
- Place the food to be grilled directly onto the wire rack.
- To catch any liquids that drip down, place the universal pan into the cooking compartment at least one level below the wire rack.

**Notes**

- The grill element switches on and off continuously. This is normal. The temperature that you set determines how frequently this occurs.
- Smoke may be produced when grilling.

**Information for those allergic to nickel**

In rare cases, small amounts of nickel may pass into the food.

**24.4 Microwave cooking**

If you use the microwave mode, you can reduce the cooking time considerably.

**General information**

- When using the microwave mode, the cooking time is determined based on the total weight. If you want to cook a quantity that differs from the specified quantity, the general rule is **Double the quantity requires just under double the cooking time.**
- The food transfers heat to the cookware. The cookware can become very hot.
- In the main part of the instruction manual, you will find information on how to configure the microwave and microwave combination oven settings.
  - → "Microwave combination", Page 17
  - → "Microwave", Page 15 → "Microwave", Page 16

### Cooking, braising or steaming using the microwave mode

- Use microwave-safe cookware with a lid. Alternatively, you can use a plate or special microwavable film to cover the dish.
- For cereal products, e.g. rice, use deep cookware with a lid. Cereal products foam a lot during cooking. Add liquid in accordance with the instructions and information provided in the recommended settings tables.
- Do not wash or dry food. Add 1-3 tablespoons of water or lemon juice to the food.
- Spread the food out so that as much of it as possible is in contact with the bottom of the cookware. Food that is in contact with the bottom will cook more quickly than food that is piled up.

- Use salt and seasoning sparingly. When cooking food using the microwave mode, most of the food's natural flavour will be retained.
- Turn or stir the food 2-3 times during cooking.
- After cooking, leave the food to rest for 2-3 minutes.

### 24.5 Cooking frozen products

- Do not use heavily frosted frozen products.
- Remove any ice.
- Some frozen products may be unevenly pre-baked. Uneven browning may remain even after baking.















### 24.6 Cooking ready meals

- Take ready meals out of the packaging.
- If you are warming or cooking the ready meal in cookware, make sure that the cookware is heat-resistant.

### 24.7 List of foods

Recommended settings for a variety of foods, sorted into food categories.

#### Recommended settings for various types of food

Food	Accessory/cook-ware	Shelf position	Heating function → Page 10	Temperature in °C	Microwave power setting in W	Cooking time in mins
Sponge cake, simple	Ring-shaped tin or Loaf tin	1		160–180	90	30–40
Sponge cake, delicate	Loaf tin	1		150–170	-	60–80
Fruit tart or cheesecake with shortcrust pastry base	Springform cake tin, diameter 26 cm	1		160–170	-	65–85
Fruit tart or cheesecake with shortcrust pastry base	Springform cake tin, diameter 26 cm	1		<b>1.</b> 160–180 <b>2.</b> 100	<b>1.</b> 180 <b>2.</b> 0	<b>1.</b> 30–40 <b>2.</b> 20
Sponge cake, 6 eggs	Springform cake tin, diameter 28 cm	1		150–170 <sup>1</sup>	-	30–50
Sponge cake, 6 eggs	Springform cake tin, diameter 28 cm	1		150–170 <sup>1</sup>	-	30–50
Sponge cake, 6 eggs	Springform cake tin, diameter 28 cm	1		150–160	-	50–60
Shortcrust tart with moist topping	Universal pan	1		150–170	-	65–85
Shortcrust tart with moist topping	Universal pan	1		160–180	-	60–80
Muffins	Muffin tray	1		170–190	-	15–30
Small yeast cakes	Baking tray	1		160–170	-	30–40
Small yeast cakes	Baking tray	1		150–160	-	30–40
Biscuits	Baking tray	2		140–160	-	15–30
Biscuits, 2 levels	Universal pan + Baking tray	3+1		130–150	-	20–35

<sup>1</sup> Preheat the appliance.

<sup>2</sup> Turn the dish 2/3 of the way through the cooking time.

<sup>3</sup> Stir the food one or two times during cooking.

Food	Accessory/cook-ware	Shelf position	Heating function → Page 10	Temperature in °C	Microwave power setting in W	Cooking time in mins
Bread, without a tin, 750 g	Universal pan or Loaf tin	1		1. 210–220 <sup>1</sup> 2. 180–190	-	1. 10–15 2. 25–35
Bread, without a tin, 1500 g	Universal pan or Loaf tin	1		1. 230–240 <sup>1</sup> 2. 200–210	-	1. 10–15 2. 40–50
Bread, without a tin, 1500 g	Universal pan or Loaf tin	1		1. 210–220 <sup>1</sup> 2. 180–190	-	1. 10–15 2. 40–50
Bread, without a tin, 1500 g	Loaf tin	1		200–210	-	35–45
Flatbread	Universal pan	1		250 - 270	-	20 - 30
Flatbread	Universal pan	1		220 - 240	-	20 - 30
Bread rolls, fresh	Baking tray	1		180–200	-	25–35
Bread rolls, fresh	Baking tray	1		170–190	-	25–35
Pizza, fresh	Baking tray	1		200 - 220	-	20 - 30
Pizza, fresh, on 2 levels	Universal pan + Baking tray	3+1		180 - 200	-	35 - 45
Pizza, fresh, thin-crust, on a pizza tray	Pizza tray	1		210 - 230	-	20 - 30
Quiche	Tart dish or tin , Black tray	1		190–210	-	35–55
Quiche	Tart dish or tin , Black tray	1		190–210	-	30–45
Tarte flambée	Universal pan	1		260 - 280 <sup>1</sup>	-	10 - 20
Bake, savoury, cooked ingredients	Ovenproof dish	1		200 - 220	-	35 - 55
Bake, savoury, cooked ingredients	Ovenproof dish	1		140 - 160	360	20 - 30
Lasagne, frozen, 400 g	Uncovered cook-ware	1		200 - 210	180	20 - 25
Potato gratin, raw ingredients, 4 cm deep	Ovenproof dish	1		170 - 180	-	50 - 65
Potato gratin, raw ingredients, 4 cm deep	Ovenproof dish	1		170 - 190	360	20 - 25
Chicken, 1 kg, unstuffed	Uncovered cook-ware	1		200 - 220	-	60 - 70
Chicken, 1 kg, unstuffed	Covered cookware	1		230 - 250	360	25 - 35
Small chicken portions, 250 g each	Wire rack	2		220 - 230	-	30 - 35
Small chicken portions, x 4, 250 g each	Uncovered cook-ware	1		190 - 210	360	20 - 30
Goose, unstuffed, 3 kg	Uncovered cook-ware	1		160 - 170	-	120 - 150
Joint of pork without rind, e.g. neck, 1.5 kg	Uncovered cook-ware	1		180 - 200	-	120 - 130
Joint of pork without rind, e.g. neck, 1.5 kg	Covered cookware	1		180 - 200	180	55 - 65

<sup>1</sup> Preheat the appliance.

<sup>2</sup> Turn the dish 2/3 of the way through the cooking time.

<sup>3</sup> Stir the food one or two times during cooking.



Food	Accessory/cook-ware	Shelf position	Heating function → Page 10	Temperature in °C	Microwave power setting in W	Cooking time in mins
Joint of pork without rind, e.g. neck, 1.5 kg	Uncovered cook-ware	1		180 - 190	-	120 - 140
Fillet of beef, medium, 1 kg	Uncovered cook-ware	1		210 - 220	-	40 - 50
Pot-roasted beef, 1.5 kg	Covered cookware	1		200 - 220	-	130 - 140
Pot-roasted beef, 1.5 kg	Covered cookware	1		200 - 220	-	140 - 160
Sirloin, medium, 1.5 kg	Uncovered cook-ware	1		220 - 230	-	60 - 70
Sirloin, medium, 1.5 kg	Uncovered cook-ware	1		240 - 260	180	30 - 40
Burger, 3-4 cm thick	Wire rack	2		290	-	20 - 30 <sup>2</sup>
Leg of lamb, boned, medium, 1.5 kg	Uncovered cook-ware	1		170 - 190	-	50 - 70
Leg of lamb, boned, medium, 1.5 kg	Covered cookware	1		240 - 260	<b>1.</b> 360 <b>2.</b> 180	<b>1.</b> 30 <b>2.</b> 35 - 40
Meat loaf, 1 kg, + 50 ml water	Uncovered cook-ware	1		170 - 190	360	30 - 40
Fish, grilled, whole, 300 g, e.g. trout	Uncovered cook-ware	1		170-190	-	20-30
Fish, grilled, whole, 300 g, e.g. trout	Wire rack	2		250	90	15-20
Vegetables, fresh, 250 g	Covered cookware	1		-	600	8 - 12 <sup>3</sup>
Baked potatoes, halved, 1 kg	Universal pan	2		200 - 220	360	15 - 20
Peeled boiled potatoes, quartered, 500 g	Covered cookware	1		-	600	12 - 15 <sup>3</sup>
Long-grain rice, 250 g,+ 500 ml water	Covered cookware	1		-	<b>1.</b> 600 <b>2.</b> 180	<b>1.</b> 7 - 9 <b>2.</b> 13 - 16
Millet, whole, 250 g, + 600 ml water	Covered cookware	1		-	<b>1.</b> 600 <b>2.</b> 180	<b>1.</b> 8 - 10 <b>2.</b> 10 - 15
Polenta or maize semolina, 125 g, + 500 ml water	Covered cookware	1		-	600	6 - 8 <sup>3</sup>

<sup>1</sup> Preheat the appliance.

<sup>2</sup> Turn the dish 2/3 of the way through the cooking time.

<sup>3</sup> Stir the food one or two times during cooking.

## Desserts

### Using the microwave mode to make popcorn

#### WARNING – Risk of burns!

Airtight packaging may burst when food is heated.

- ▶ Always follow the instructions on the packaging.
- ▶ Always use oven gloves to remove the dishes from the cooking compartment.

1. Use shallow, heat-resistant glass cookware, e.g. the lid of an ovenproof dish.  
Do not use porcelain or deep plates.
2. Place the popcorn bag onto the cookware according to the instructions on the packaging.
3. Use the recommended settings when configuring the appliance settings.
4. The time may need to be adjusted, depending on the product and quantity in question.
5. Remove the popcorn bag after 1½ minutes and shake it to ensure that the popcorn doesn't burn.

6. Place the popcorn bag back into the oven and leave it to continue popping.
7. Once you can only hear popping noises once every 2-3 seconds, switch off the appliance and take the popcorn bag out of the oven.
8. Wipe the cooking compartment clean afterwards.

#### Making yoghurt

1. Remove the accessories and shelves from the cooking compartment.
2. Heat 1 litre of whole milk (3.5% fat) to 90 °C on the hob and then leave it to cool down to 40 °C. It is sufficient to heat UHT milk to 40 °C.
3. Mix 150 g of chilled yoghurt into the milk.
4. Pour the mixture into small containers, e.g. cups or small jars.
5. Cover the containers with film, e.g. cling film.
6. Place the containers on the cooking compartment floor.

7. Use the recommended settings when configuring the appliance settings.

8. After making the yoghurt, leave it to cool in the refrigerator for at least 12 hours.

### Recommended settings for desserts and compote

Food	Accessory/cookware	Shelf position	Heating function → Page 10	Temperature in °C	Microwave power setting in W	Cooking time in mins
Blancmange made from blancmange powder	Covered cookware	1		-	600	5 - 8 <sup>1</sup>
Yoghurt	Individual moulds	Cooking compartment floor		40 - 45	-	8 - 9 hrs
Rice pudding, 125 g, + 500 ml milk	Covered cookware	1		-	<b>1.</b> 600 <b>2.</b> 180	<b>1.</b> 10 <b>2.</b> 20 - 25 <sup>1</sup>
Fruit compote, 500 g	Covered cookware	1		-	600	9 - 12
Microwave popcorn, 1 x 100 g bag <sup>2</sup>	Uncovered cookware	1		-	600	4 - 6

<sup>1</sup> Stir the food one or two times during cooking.

<sup>2</sup> Place the sealed bag on the cookware.

## 24.8 Special cooking methods and other applications

Information and recommended settings for special cooking methods and other applications, e.g. slow cooking or preserving.

### Slow cooking

Cook prime cuts of meat slowly at a low temperature, e.g. tender cuts of beef, veal, lamb or poultry.

### Low temperature cooking poultry or meat

**Note:** When using the low temperature cooking type of heating, you cannot delay the start of the programme by setting an end time.

**Requirement:** The cooking compartment is cold.

1. Use fresh, clean, hygienic meat without bones.
2. Place the cookware onto the wire rack at level 1 in the cooking compartment.
3. Preheat the cooking compartment and cookware for approx. 15 minutes.
4. Sear the meat on all sides on the hob at a very high heat.
5. Immediately place the meat into the pre-warmed cookware in the cooking compartment. To ensure that the climate in the cooking compartment remains constant, keep the cooking compartment door closed during low temperature cooking.
6. After low temperature cooking, remove the meat from the cooking compartment.

### Recommended settings for slow cooking

Food	Accessory/cookware	Shelf position	Searing time in mins	Heating function → Page 10	Temperature in °C	Cooking time in mins
Duck breast, medium rare, 300 g each	Uncovered cookware	1	6 - 8		95 <sup>1</sup>	45 - 60
Fillet of pork, whole	Uncovered cookware	1	4 - 6		85 <sup>1</sup>	45 - 70
Fillet of beef, 1 kg	Uncovered cookware	1	4 - 6		85 <sup>1</sup>	90 - 120
Veal medallions, 4 cm thick	Uncovered cookware	1	4		80 <sup>1</sup>	40 - 60
Saddle of lamb, boneless, 200 g each	Uncovered cookware	1	4		85 <sup>1</sup>	30 - 45

<sup>1</sup> Preheat the appliance.

### Defrosting

You can defrost frozen food in your appliance.

#### Tips for defrosting food

- You can use the "microwave" mode to defrost frozen fruit, vegetables, poultry, meat, fish or baked goods.

- Remove frozen food from its packaging before you defrost it.
- Use heat-resistant, microwave-safe cookware.
- The recommended settings are for freezer-temperature food (-18 °C).

- Defrosting works best if you divide it into more than one step. The steps are listed one after the other in the recommended settings tables.
- Stir or turn the food 1-2 times during defrosting. Turn large items several times. Split the food into smaller pieces as it defrosts. Remove pieces that have already defrosted from the cooking compartment.
- Once the food has defrosted, switch off the appliance and leave the food in the appliance for another 10 to 30 minutes to allow the temperature to equalise.

**Recommended settings for defrosting**

Food	Accessory/cook-ware	Shelf position	Heating function → Page 10	Temperature in °C	Microwave power setting in W	Cooking time in mins
Bread, 500 g	Uncovered cook-ware	1		-	1. 180 2. 90	1. 3 2. 10 - 15
Bread rolls	Wire rack	1		140 - 160	90	2 - 4
Cakes, moist, 500 g	Uncovered cook-ware	1		-	1. 180 2. 90	1. 2 2. 10 - 15
Cakes, dry, 750 g	Uncovered cook-ware	1		-	90	10 - 15
Meat, whole, e.g. joint, raw meat, 1 kg	Uncovered cook-ware	1		-	1. 180 2. 90	1. 15 2. 20 - 30 <sub>1</sub>
Minced meat, mixed, 500 g	Uncovered cook-ware	1		-	1. 180 2. 90	1. 5 2. 10 - 15 <sub>1</sub>
Chicken, whole, 1.2 kg	Uncovered cook-ware	1		-	1. 180 2. 90	1. 10 2. 10 - 15 <sub>1</sub>
Fish, whole, 300 g	Uncovered cook-ware	1		-	1. 180 2. 90	1. 3 2. 10 - 15 <sub>1</sub>
Berries, 300 g	Uncovered cook-ware	1		-	180	5 - 10
Butter, defrosting, 125 g	Uncovered cook-ware	1		-	90	7 - 9

<sup>1</sup> Turn the dish halfway through the cooking time.

**Warming up food using the microwave mode**

You can use the microwave mode to warm up food or to defrost and warm up food in a single step.

**Tips for warming up food using the microwave mode**

- Use microwave-safe cookware with a lid.
- Turn or stir the food 2-3 times during warming.
- After warming up the food, leave it to rest for 1-2 minutes.
- The food transfers heat to the cookware. The cookware can become very hot.
- Make sure that you do the following when you are warming up baby food:
  - Place bottles on the wire rack without the teat or lid.
  - Shake or stir the baby food well after warming it up.
  - Always check the temperature of the baby food.
- Wipe the cooking compartment dry after using it to warm up food.

**⚠ WARNING – Risk of scalding!**

There is a possibility of delayed boiling when a liquid is heated. This means that the liquid reaches boiling temperature without the usual steam bubbles rising to the surface. Even if the container only vibrates a little, the hot liquid may suddenly boil over and spatter.

- Always place a spoon in the container when heating liquids. This will prevent delayed boiling.

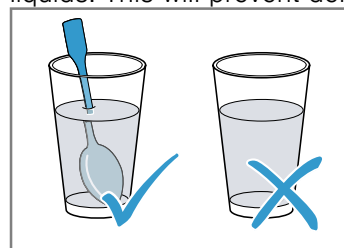

**ATTENTION!**

Metal touching the wall of the cooking compartment will cause sparks, which may damage the appliance or the inner door pane.

- ▶ Metal (e.g. a spoon in a glass) must be kept at least 2 cm from the cooking compartment walls and the inside of the door.

**Recommended settings for warming up food using the microwave mode**

Food	Accessory/cook-ware	Shelf position	Heating function → Page 10	Temperature in °C	Microwave power setting in W	Cooking time in mins
Drinks, warming up, 200 ml	Uncovered cookware	1		-	1000	1 - 3 <sup>1</sup>
Baby food, heating up, e.g. baby bottle, 150 ml	Uncovered cookware	1		-	360	1 - 3 <sup>1</sup>
Vegetables, chilled, 250 g	Covered cookware	1		-	600	3 - 8
Side dishes, e.g. pasta, dumplings, potatoes, rice Chilled	Covered cookware	1		-	600	5 - 10
Soup, stew, 400 ml Chilled	Covered cookware	1		-	600	5 - 7
Plated meal, 1 portion Chilled	Covered cookware	1		-	600	4 - 8
Bakes, 400 g, e.g. lasagne, potato gratin	Uncovered cookware	1		180 - 200	180	20 - 25
Side dishes, 500 g, e.g. pasta, dumplings, potatoes, rice Frozen	Covered cookware	1		-	600	7 - 10
Soup, stew, 200 ml Frozen	Covered cookware	1		-	600	4 - 6 <sup>1</sup>
Plated meal, 1 portion Frozen	Covered cookware	1		-	600	11 - 15

<sup>1</sup> Stir the food well.

**Keeping food warm****Tips for keeping food warm**

- Using the "Keep warm" heating function prevents condensation from forming. You will not have to wipe down the cooking compartment.
- To prevent the food from drying out, you can cover it.
- Do not keep food warming for longer than 2 hours.
- Be aware that some types of food will actually continue cooking when you are keeping them warm in the oven.

**24.9 Test dishes**

The information in this section is provided for test institutes to facilitate testing of the appliance in accordance with EN 60350-1:2013 or IEC 60350-1:2011 and EN 60705:2012 or IEC 60705:2010.

**Baking**

- The setting values apply to food that is placed into a cold cooking compartment.
- Please take note of the information on preheating in the recommended settings tables. These setting values assume that the rapid heat-up function is not being used.
- For baking, use the lower of the specified temperatures to start with.
- Items that are placed in the appliance on baking trays or in baking tins/dishes at the same time will not necessarily be ready at the same time.
- Shelf positions when baking on 2 levels:
  - Universal pan: Shelf position 3
  - Baking tray: Shelf position 1

- Hot water sponge cake

- When baking on two levels, place the springform tins at diagonally opposite corners of the wire racks.

### Recommended settings for baking

Food	Accessory/cookware	Shelf position	Heating function → <i>Page 10</i>	Temperature in °C	Cooking time in mins
Viennese whirls	Baking tray	1		150–160 <sup>1</sup>	20–30
Viennese whirls	Baking tray	1		140–150 <sup>1</sup>	25–35
Small cakes	Baking tray	1		160 <sup>1</sup>	25–35
Small cakes	Baking tray	1		150 <sup>1</sup>	20–30
Small cakes	Baking tray	1		150 <sup>1</sup>	20–30
Small cakes, 2 levels	Universal pan + Baking tray	3+1		140 <sup>1</sup>	30–40
Hot water sponge cake	Springform cake tin, diameter 26 cm	1		160–170 <sup>2</sup>	25–35
Hot water sponge cake	Springform cake tin, diameter 26 cm	1		160–170 <sup>2</sup>	30–45

<sup>1</sup> Preheat the appliance for five minutes. Do not use the rapid heating function.

<sup>2</sup> Preheat the appliance. Do not use the rapid heating function.

### Recommended settings for grilling

Food	Accessory/cookware	Shelf position	Heating function → <i>Page 10</i>	Temperature in °C	Cooking time in mins
Toasting bread	Wire rack	3		290	3–6

### Microwave cooking

- If you use the wire rack, slide it into the cooking compartment with the **Microwave** imprint facing the appliance door and the bump pointing downwards.
- To test the microwave mode on its own, switch off the drying function in the basic settings. → *Page 23*



### Recommended settings for defrosting food using the microwave mode

Food	Accessories/cookware	Shelf position	Heating function → <i>Page 10</i>	Microwave power setting in W	Cooking time in mins
Meat	Uncovered cookware	1		1. 180 2. 90	1. 5 2. 10–15

### Recommended settings for microwave cooking

Food	Accessories/cookware	Shelf position	Heating function → <i>Page 10</i>	Microwave power setting in W	Cooking time in mins
Egg wash	Uncovered cookware	1		1. 360 2. 180	1. 20 2. 20–25
Sponge	Uncovered cookware	1		600	7–9
Meat loaf	Uncovered cookware	1		600	22–27

## Recommended settings for cooking in combination with the microwave mode

Food	Accessory/cook-ware	Shelf position	Heating function → <i>Page 10</i>	Temperature in °C	Microwave power setting in W	Cooking time in mins
Potato gratin	Uncovered cook-ware	1		150 - 170	360	25 - 30
Cakes	Uncovered cook-ware	1		190 - 210	180	12 - 18
Chicken	Uncovered cook-ware	1		180 - 200	360	25 - 35 <sup>1</sup>

<sup>1</sup> Turn the dish 2/3 of the way through the cooking time.

## 25 Installation instructions



Observe this information when installing the appliance.



### 25.1 General installation instructions

Follow these instructions before you start with the installation of the appliance.

- The installation cabinet must not have a back panel behind the appliance. There should be a gap of at least 35 mm between the wall and the cabinet base as well as the rear panel of the cabinet situated above.
- Ventilation slots and intake openings must not be covered.
- The safe operation of this appliance can only be guaranteed if it has been installed to a professional standard in accordance with these installation instructions. The installer shall be liable for damages incurred as a result of incorrect installation.
- Check the appliance for damage after unpacking it. Do not connect the appliance if it has been damaged in transit.
- Before starting up the appliance, remove any packaging material and adhesive film from the cooking compartment and the door.
- Proceed in accordance with the installation sheets for installing accessories.
- Fitted units must be heat-resistant up to 95 °C, and adjacent unit fronts up to 70 °C.

- Do not install the appliance behind a decorative door or the door of a kitchen unit. There is a risk of overheating.
- Cut-out work on the units should be carried out before installing the appliance. Remove any shavings. Otherwise, the correct operation of electrical components may be adversely affected.
- The mains socket for the appliance must either be located in the hatched area  or outside of the area where the appliance is installed. Any unsecured units must be secured to the wall using a standard bracket .

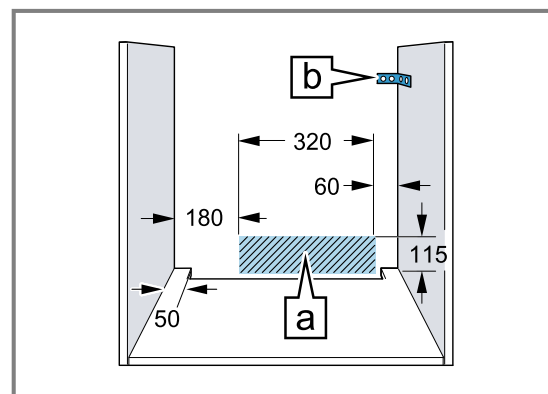

- Wear protective gloves so that you do not cut yourself. Parts that are accessible during installation may have sharp edges.
- Dimensions of the figures in mm.

### **WARNING – Danger: Magnetism!**

Permanent magnets are used in the control panel or in the controls. They may affect electronic implants, e.g. pacemakers or insulin pumps.

- ▶ Wearers of electronic implants must stay at least 10 cm away from the control panel or controls during the installation.



**⚠ WARNING – Risk of fire!**

It is dangerous to use an extended power cord and non-approved adapters.

- ▶ Do not use multiple socket strips.
- ▶ Only use extension cables that are certified, have a minimum cross section of 1.5 mm<sup>2</sup> and comply with the applicable national safety requirements.
- ▶ If the power cord is too short, contact customer service.
- ▶ Only use adapters approved by the manufacturer.

**ATTENTION!**

Carrying the appliance by the door handle could break it. The door handle cannot support the weight of the appliance.

- ▶ Do not carry or hold the appliance by the door handle.

**25.2 Appliance dimensions**

You will find the dimensions of the appliance here

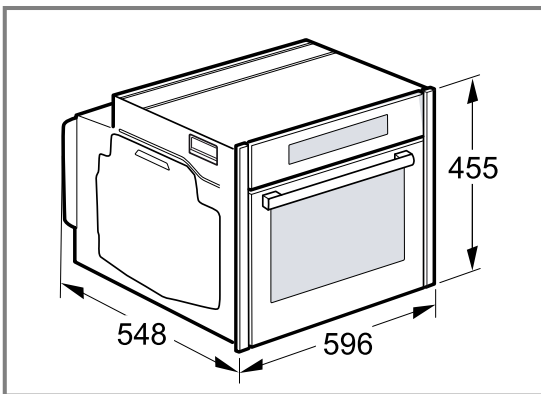

**25.3 Installation below a worktop**

Observe the installation dimensions and the installation instructions when installing below a worktop.

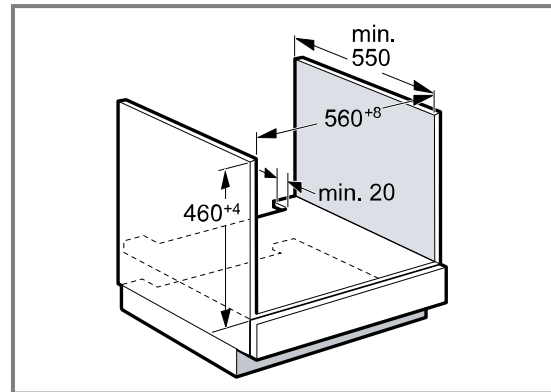

- To ventilate the appliance, the intermediate floor must have a ventilation cut-out.
- The worktop must be secured to the fitted unit.
- Observe any available installation instructions for the hob.
- Observe different national installation instructions for the hob.

**25.4 Installation underneath a hob**

If the appliance is installed under a hob, the following minimum dimensions must be adhered to (including substructure, if applicable).

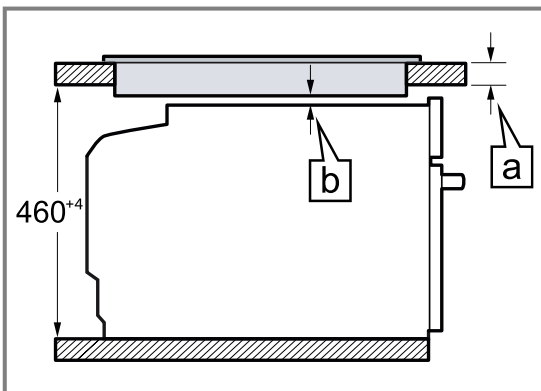

The minimum worktop thickness **[a]** is based on the required minimum clearance **[a]**.

Hob type	a raised in mm	a flush in mm	b in mm
Induction hob	42	43	5
Full-surface induction hob	52	53	5
Gas hob	32	43	5 <sup>1</sup>
Electric hob	32	35	2

<sup>1</sup> Observe different national installation instructions for the hob.

## 25.5 Installation in a tall unit

Observe the installation dimensions and the installation instructions when installing in a tall unit.

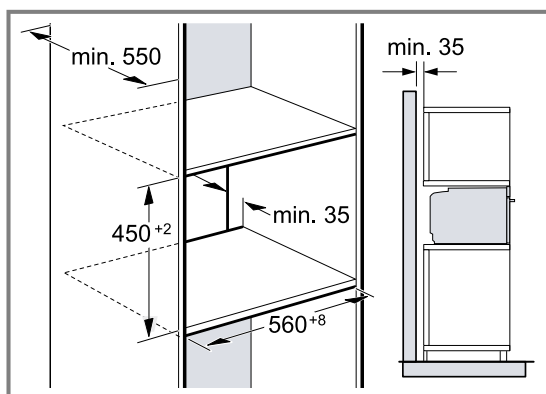

- To ventilate the appliance, the intermediate floors must have a ventilation cut-out.
- In order to ensure sufficient ventilation of the appliance, there must be a ventilation opening of at least 200 cm<sup>2</sup> in the base area. To do this, trim the base panel or fit a ventilation grille. Ensure that the air exchange is guaranteed in accordance with the diagram.

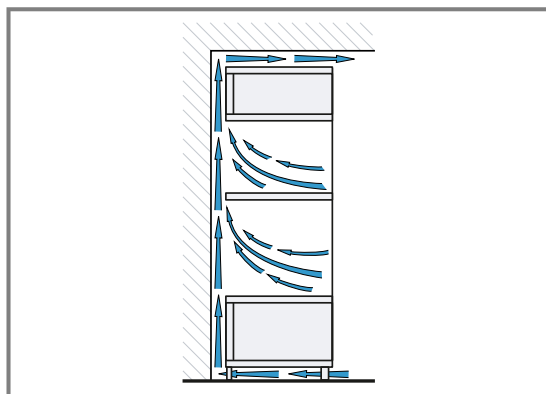

- If the tall unit has another back panel in addition to the element back panels, this must be removed.
- Only fit the appliance up to a height which allows accessories to be easily removed.

## 25.6 Corner installation

Observe the installation dimensions and the installation instructions when installing in a corner.

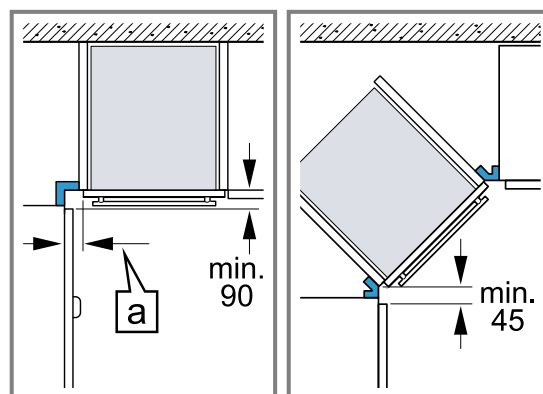

- To ensure that the appliance door can be opened, you must take the minimum dimensions into consideration when installing in a corner. The dimension [a] is dependent on the thickness of the unit front and the handle.

## 25.7 Electrical connection

In order to safely connect the appliance to the electrical system, follow these instructions.

- The appliance corresponds to protection class I and must only be operated with a protective earth connection.
- The fuse protection must correspond to the power rating specified on the appliance's rating plate and to the local regulations.
- The appliance must be disconnected from the power supply whenever installation work is being carried out.
- The appliance must only be connected using the power cable provided.
- The power cable must be plugged in at the rear of the appliance until you hear a clicking sound. A 3 m power cable can be obtained from the after-sales service.
- The power cable must only be replaced with a cable from the original manufacturer. This is available from after-sales service.
- Contact protection must be guaranteed by the installation.

### Electrically connect the appliance with the protective contact plug

**Note:** The appliance must only be connected to a protective contact socket that has been correctly installed.

- ▶ Insert the plug into the protective contact socket. When the appliance is installed, the mains plug of the power cord must be freely accessible. If free access to the mains plug is impossible, an all-pole

isolating switch must be integrated into the permanent electrical installation in accordance with the installation regulations.

### Electrically connecting an appliance without a protective contact plug

**Note:** Only a licensed professional may connect the appliance. Damage caused by incorrect connection is not covered under the warranty.

An all-pole isolating switch must be integrated into the permanent electrical installation according to the installation regulations.

1. Identify the phase and neutral conductors in the socket.  
The appliance may be damaged if it is not connected correctly.
2. Connect the hob in accordance with the connection diagram.  
See the rating plate for the voltage.
3. Connect the wires of the mains power cable according to the colour coding:
  - Green/yellow = Protective conductor ⊕
  - Blue = Neutral conductor
  - Brown = Phase (external conductor)

## 25.8 Installing the appliance

**Note:** Do not use a cordless screwdriver to secure the panels. This may damage the panels.

1. Push the appliance in fully.  
Do not kink or trap the connection cable, or route it over sharp edges.
2. Centre the appliance.

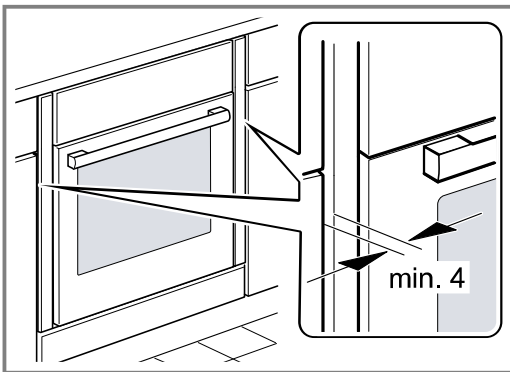

There must be an air gap of at least 4 mm between the appliance and adjacent unit fronts.

3. Open the appliance door and unscrew the left and right-hand panels.

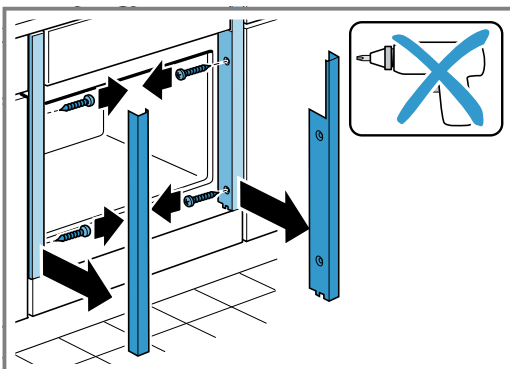

4. Close the appliance door.

5. Screw the appliance into place.

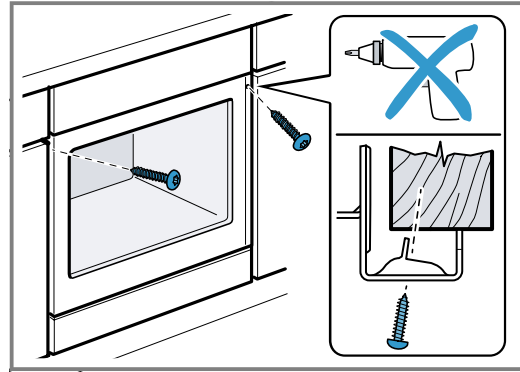

6. For handleless kitchens with vertical bar handle strips:
  - Attach a suitable filling piece ① in order to cover any sharp edges and to guarantee a safe installation.
  - Pre-drill aluminium profiles to establish a screw connection ②.
  - Secure the appliance using a suitable screw ③.

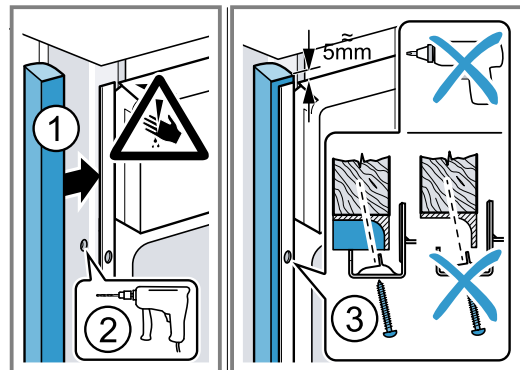

7. Refit the panels and screw them in place, first at the top and then at the bottom.

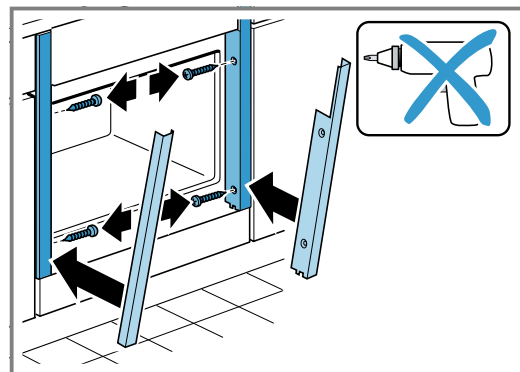

8. If required, the gap between the appliance door and the side panels can be adjusted using the screws at the top left and right.

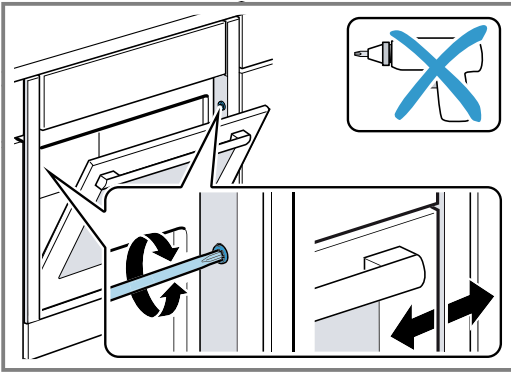

**Note:** The gap between the worktop and the appliance must not be closed by additional battens. Thermal insulation strips must not be fitted to the side panels of the surround unit.

### 25.9 Removing the appliance

1. Disconnect the appliance from the power supply.
2. Open the appliance door and unscrew the left and right-hand panels.
3. Undo the fastening screws.
4. Lift the appliance slightly and pull it out completely.



A series of horizontal lines spanning the width of the page, designed for writing. The lines are evenly spaced and extend across the entire width of the page.



A blank sheet of lined paper with horizontal ruling lines spaced evenly down the page.





Valid within Great Britain:  
Imported to Great Britain by  
BSH Home Appliances Ltd.  
Grand Union House  
Old Wolverton Road  
Wolverton, Milton Keynes  
MK12 5PT  
United Kingdom

REGISTER YOUR PRODUCT  
ONLINE [NEFF-HOME.COM](http://NEFF-HOME.COM)



BSH Hausgeräte GmbH  
Carl-Wery-Straße 34  
81739 München, GERMANY

9001749860  
020804  
en