

RAILS EXTENSION COMPLETS, 3 NIVEAUX
Z12TF36X0

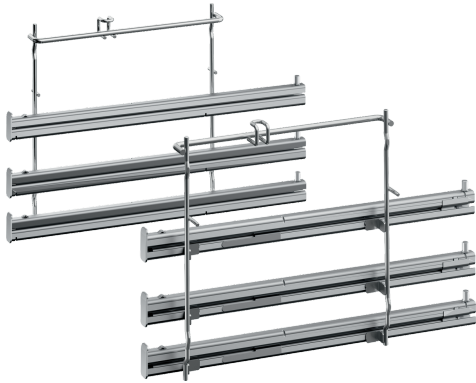

Équipement

Données techniques

Dimensions du produit emballé: 85 x 300 x 420 mm
Dimensions de la palette (mm): 95.0 x 80.0 x 120.0
Colisage par palette: 48
Poids net: 3.3 kg
Poids brut: 3.6 kg
Code EAN: 4242004182948

